

# LED Stadium Eyes Light Series

Wattages: 800W, 1000W



The Stadium Eyes LED Lighting Series can be widely used for Indoor or Outdoor (Wet Location) Excellent for Large outdoor fields -stadiums, riding arenas, baseball and football fields, Other large outdoor areas: parks, docks, shipyard, airport and many other applications.



## FEATURES

- LED high luminous efficiency and long working life.
- High efficiency LED Driver, the wide range input voltage AC200-480V.
- Die-cast aluminum cooling design, high quality and better cooling for LED  $T_j < 85^{\circ}\text{C}$ .
- Excellent optics design, greatly improve the light utilization and evenness.
- 12V auxiliary (Standard) / Dali dimming (Optional)

## LIGHTING ANGLE

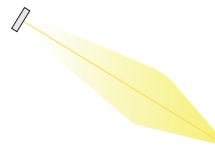

NEMA III

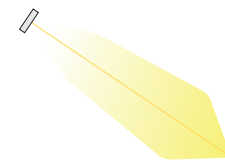

NEMA IV

## SPECIFICATION

	WSD-SE80W48-50K-S-N3-T	WSD-SE100W48-50K-S-N3-T
TYPE	WSD-SE80W48-50K-S-N3-T	WSD-SE100W48-50K-S-N3-T
WATTAGE	800W	1000W
LUMEN	118938 lm	149460 lm
EFFICACY	$\geq 145$ lm/W	$\geq 145$ lm/W
CCT	4000K, 5000K	
CRI	80	
INPUT VOLTAGE	AC200-480V	
LIGHTING ANGLE	NEMA III, IV	
FIELD ANGLE (10% LMAX)	39.6 (III), 55.1 (IV)	
BEAM ANGLE (50% LAMX)	22.1 (III), 32.5 (IV)	
POWER FACTOR	0.95	
DRIVER EFFICACY	92%	
DIMMING	12V auxiliary	
LIFE SPAN	up to 75,000 hrs	
WORKING TEMPERATURE	-22°F ~ 113°F	
STORAGE TEMPERATURE	-40°F ~ 176°F	
OUTDOOR RATING	Wet location	
CABLE	3core, 16AWG (118 inch)	
WARRANTY	5 year limited	

# LED Stadium Eyes Light Series

Wattages: 800W, 1000W

## DIMENSION

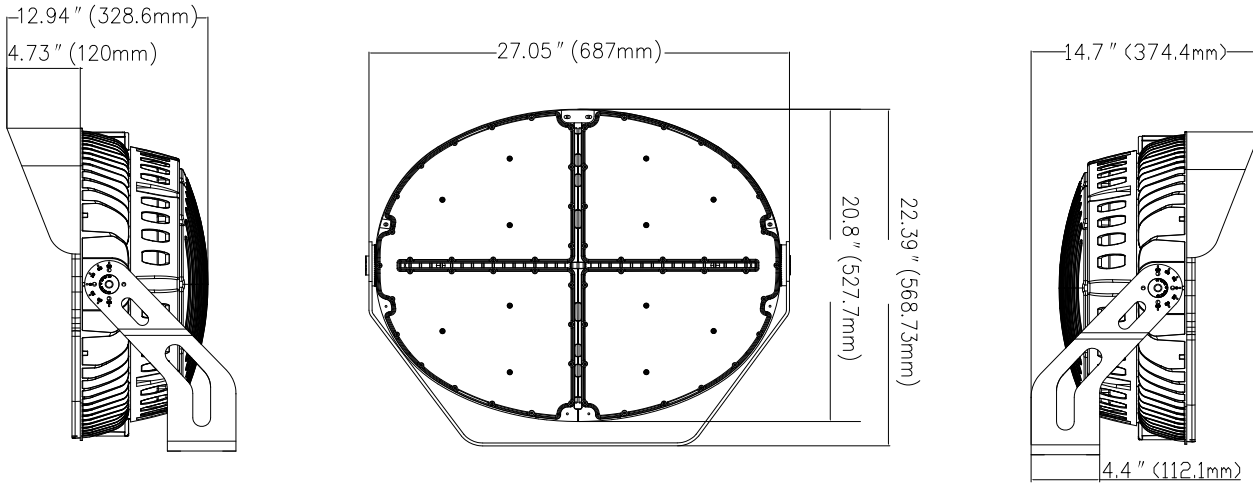

EPA	4.3 ft <sup>2</sup>	
NET WEIGHT	65.2 lbs	66.36 lbs

BOX DIMENSION 28.1" x 25.0" x 10.6" (1Pcs/CTN)

## ELECTRICAL LOAD

WATTAGE	CURRENT (VOLTAGE) (AMP)				
	208V	240V	277V	347V	480V
WSD-SE80W	3.85 Amp	3.3 Amp	2.89 Amp	2.3 Amp	1.67 Amp
WSD-SE100W	4.8 Amp	4.2 Amp	3.61 Amp	2.88 Amp	2.08 Amp

## ORDERING INFORMATION

EXAMPLE:

WSD-SE80W48-XXK-Z[D,W,B,S]-NM[N3,N4]-U[S,T]/WSD-SE100W48-XXK-Z[D,W,B,S]-NM[N3,N4]-U[S,T]

WSD	SE	80W	48	XXK	Z	NM	U
COMPANY	PRODUCT	WATTAGE	VOLTAGE	CCT	FINISH	LIGHT ANGLE	MOUNTING
WSD LED INC	SE (Stadium Eyes Light Series)	80W - (800W) 100W - (1000W)	48 (AC200-480V)	40K - (4000K) 50K - (5000K)	D - (Dark Bronze) W - (White) B - (Black) S - (Silver)	N3 - (Nema III) N4 - (Nema IV)	S - (Slipfitter) T - (Trunnion)  <b>Notice:</b> Trunnion (Standard)

# LED Stadium Eyes Light Series

Wattages: 800W, 1000W

ACCESSORIES (SOLD SEPARATELY)

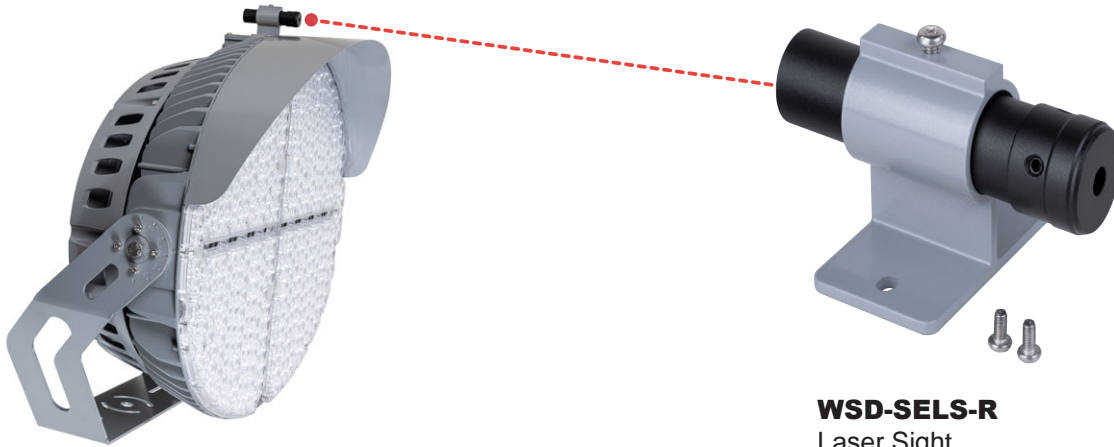

**WSD-SELS-R**  
Laser Sight  
The luminaire is used for positioning during installation

## PHOTOMETRICS

For complete IES files, please visit our website.

### WSD-SE80W48-50K-S-N4

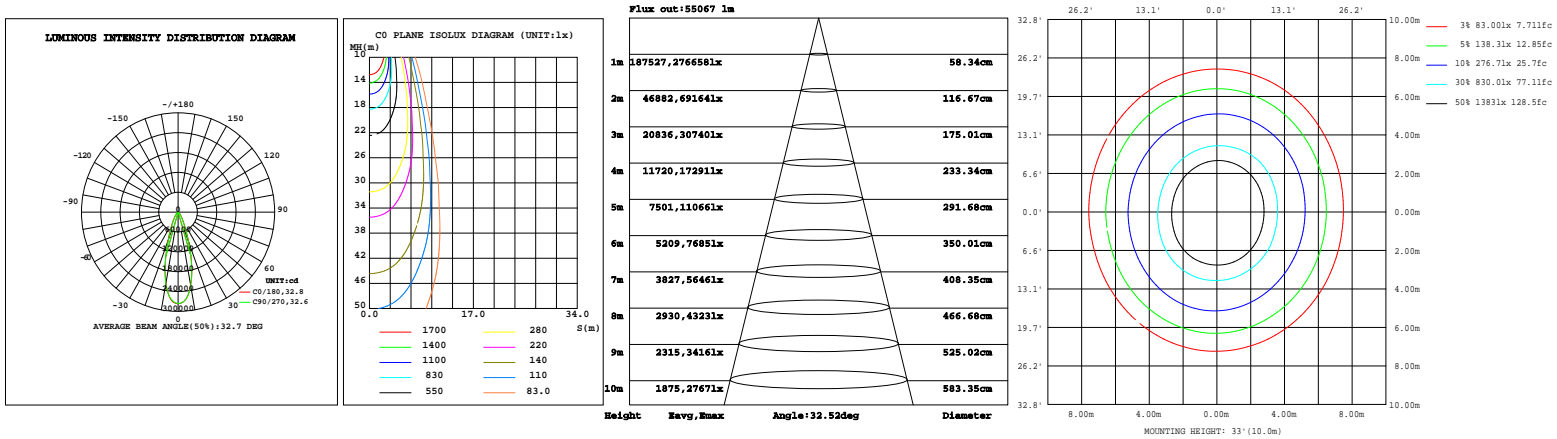

### WSD-SE100W48-50K-S-N4

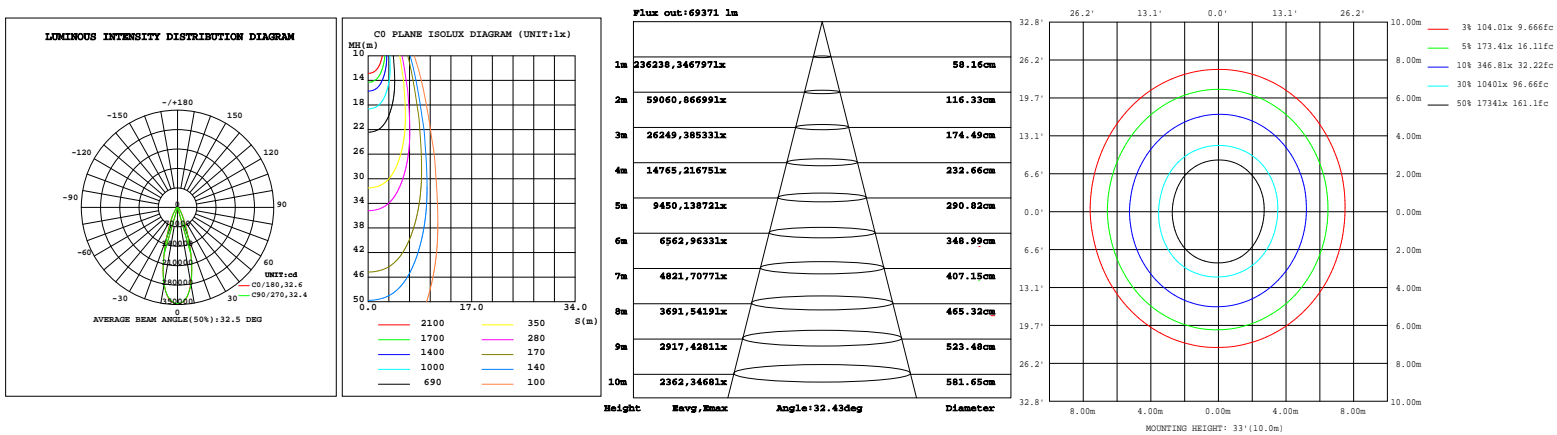

# LED Stadium Eyes Light Series

Wattages: 800W, 1000W

## CONTROLS (Optional)

For complete IES files, please visit our website.

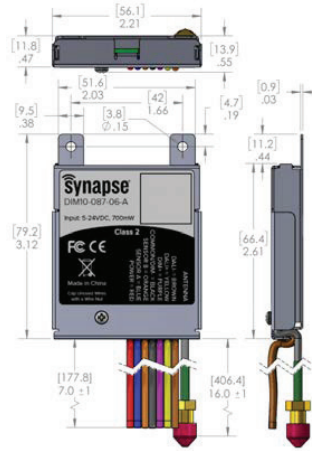
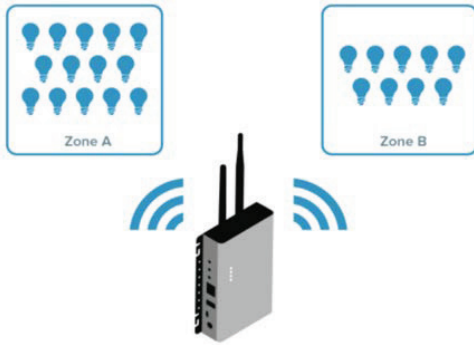

## DALI-2/DIM TO OFF WIRELESS LIGHTING CONTROLLER

### DIM10-087-06-A

INPUT	5 to 24V DC, 700 mW max
DALI-2	Limited to 8 LED Drivers
SENSOR INPUT	Analog: 0-10V / Digital: 0-24V
IP RATING	IP30
DIMMING	0-10V, 10 mA (Max)
WORKING TEMPERATURE	-40°F ~ 185°F
RADIO	SNAP 2.4GHz ; 802.15.4 +20 dBm Transmit Power -103 dBm Receive Sensitivity
WIRE SIZE	20 AWG, 6" Wires, 600V
CERTIFICATIONS	UL Recognized Component; CE; FCC/ IC; Indoor/Outdoor
WARRANTY	5 year limited

## WIRING DIAGRAM

