

MONTE CARLO

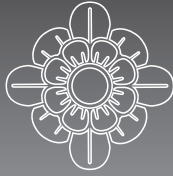

CEILING FAN COMPANY

Owner's Guide and Installation Manual

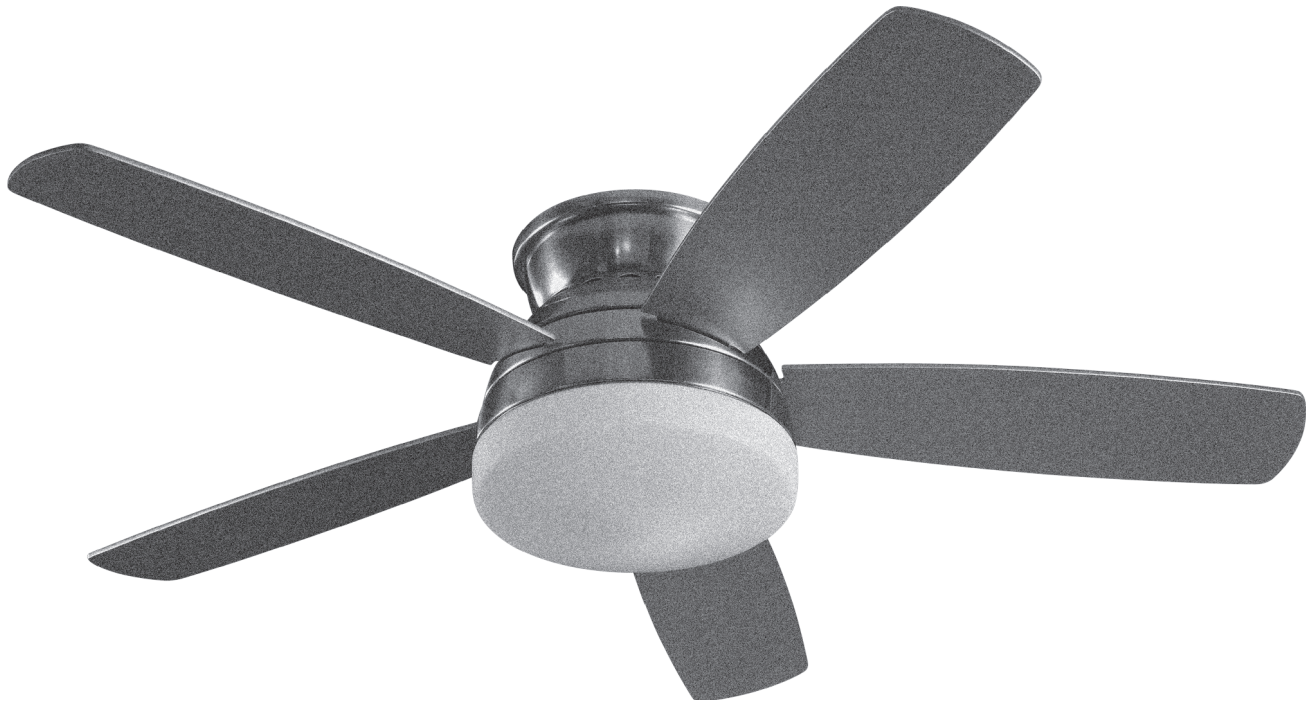

5TV52XXXD-V1 Series Fan

CUL Model No. : 5TV52XXXD-V1

Attach sales receipt to this card and retain as your proof of purchase

DATE OF PURCHASE: _____

RETAILER NAME: _____

MODEL NUMBER: _____

RETAILER ADDRESS: _____

To register your fixture, please visit our website www.montecarlofans.com



10.6 kgs
23.4 lbs

Total fan weight with light kit



Cautions and Warnings

WARNING: TO REDUCE THE RISK OF FIRE, ELECTRIC SHOCK, OR INJURY TO PERSONS, OBSERVE THE FOLLOWING READ AND SAVE THESE INSTRUCTIONS

Installation work and electrical wiring must be done by qualified person(s) in accordance with applicable codes and standards (ANSI/NFPA 70-1999), including fire-rated construction.

Use this unit only in the manner intended by the manufacturer. If you have any questions contact the manufacturer.

After making the wire connections, the wires should be spread apart with the grounded conductor and the equipment-grounding conductor on one side of the outlet box and ungrounded conductor on the other side of the outlet box. The splices, after being made, should be turned upward and pushed carefully up into the outlet box.

WARNING: Before you begin installing the fan, servicing or cleaning unit, Switch power off at Service panel and lock service disconnecting means to prevent power from being switched on accidentally. When the service disconnecting means cannot be locked, securely fasten a prominent warning device, such as a tag, to the service panel.

Be cautious! Read all instructions and safety information before installing your new fan. Review the accompanying assembly diagrams.

When cutting or drilling into wall or ceiling, do not damage electrical wiring and other hidden utilities.

Make sure the installation site you choose allows the fan blades to rotate without any obstructions. Allow a minimum clearance of 7 feet from the floor to the trailing edge of the blade.

WARNING: To Reduce The Risk Of Fire, Electric Shock, or Personal Injury, Mount To Outlet Box Marked "Acceptable for Fan Support of 15.9 kg (35 lbs) or less" And Use Mounting Screws Provided With The Outlet Box.

CAUTION: For Compliance with Local Codes and Regulations, If Installing The Secondary Support Safety Cable in the U.S., Do Not Remove Knockouts In The Outlet Box. Mount the secondary support safety cable through the reserved nail/screw hole on the outlet box to the building structure (or the ceiling joist).

WARNING: To reduce the risk of personal injury, do not bend blade holders during installation to motor, balancing or during cleaning. Do not insert foreign object between rotating blades.

Attach the mounting bracket using only the hardware supplied with the outlet box.

WARNING: To reduce the risk of fire or electric shock, this fan must be installed with an isolating wall control/switch.

WARNING: To reduce the risk of fire or electric shock, do not use this fan with any solid state fan speed control device, or variable speed control.

If this unit is to be installed over a tub or shower, it must be marked as appropriate for the application.

Never place a switch where it can be reached from a tub or shower.

The combustion airflow needed for safe operation of fuel-burning equipment may be affected by this unit's operation. Follow the heating equipment manufacturer's guideline safety standards such as those published by the National Fire Protection Association (NFPA), and the American Society for Heating, Refrigeration and Air Conditioning Engineers (ASHRAE) and the local code authorities.

CAUTION: To Reduce the Risk of Electric Shock, Disconnect the electrical supply circuit to the fan before installing the light kit.

All set screws must be checked and tightened where necessary before installation.

Tools Required for Assembly (not included): Electrical Tape, Phillips Screwdriver, Pliers, Safety Glasses, Stepladder and Wire Strippers.

Customer Service
800-969-3347

Customer Service Center
7400 Linder Ave.
Skokie, IL 60077
www.montecarlofans.com



1 Before you begin installing the fan, Switch power off at Service panel and lock service disconnecting means to prevent power from being switched on accidentally. When the service disconnecting means cannot be locked, securely fasten a prominent warning device, such as a tag, to the service panel.

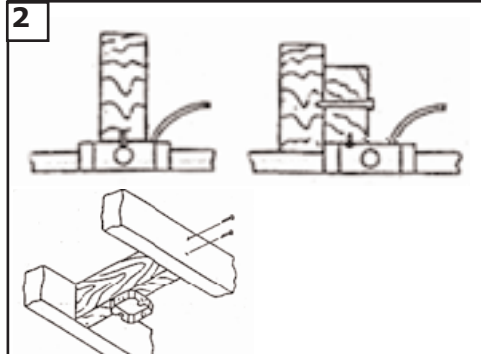

2 Before installing this fan make sure the outlet box is properly installed to the house structure. To reduce the risk of fire, electric shock, or personal injury, mount to outlet box or supporting system acceptable for fan support. (Mounting must support at least 35 lbs.)



3 Place the decorative ring on the motor housing.

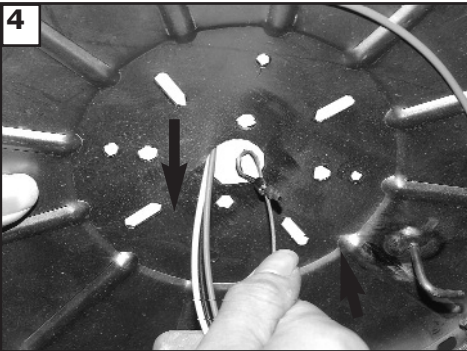

4 Thread safety cable through center hole of the mounting plate. Thread your house wires through center hole also. These will be needed for wiring of the fan.

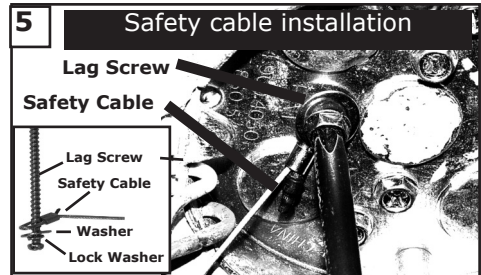

For Canadian installation and for USA fan and light kit combinations over 35 lbs, in both flush and downrod mode the safety cable must be installed into the house structure beams using the 3" lag screws provided. Make sure that when the safety cable is fully extended the leadwires are longer than the cable and no stress is placed on the leadwires. **Note:** If Installing The Secondary Support Safety Cable in the U.S., Do Not Remove Knockouts In The Outlet Box.

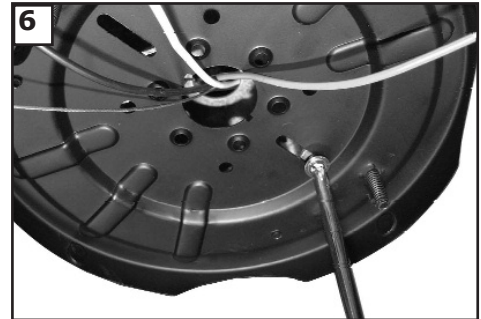

6 Securely attached the mounting plate to the outlet box using two screws supplied by the outlet box. **Use metal outlet box suitable for fan support (must support 35 lbs).**

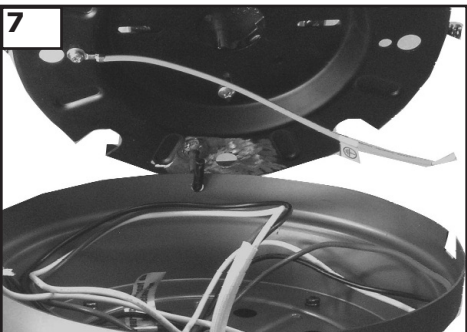

7 Carefully lift the fan motor assembly and engage the slot in the motor housing with the hook on the mounting plate so that the motor is securely suspended.

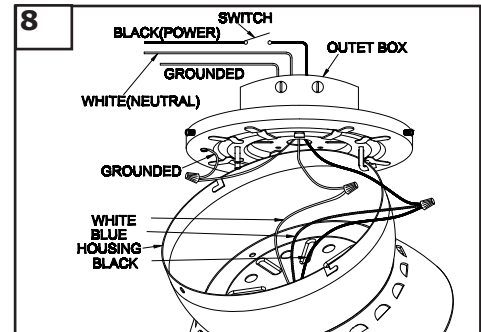

Connect black and blue wire from fan to Black or (Hot) wire from house. Connect White wire from Fan to White (Neutral) wire from house. Connect Ground leads from mounting bracket and downrod to Ground lead from house. **Refer to Safety Tips section of manual.**

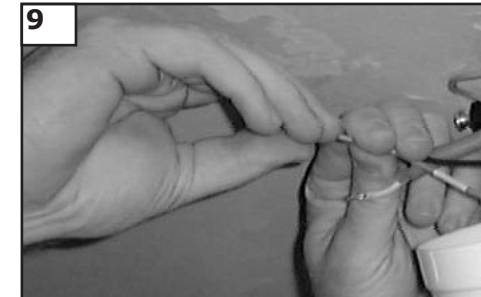

9 Make wire connections to power source using wire nuts provided. Make sure that no filaments are outside of the wirenut. After making the wire connections, the wires should be spread apart with the grounded conductor and the equipment-grounding conductor on one side of the outlet box and ungrounded conductor on the other side of the outlet box.

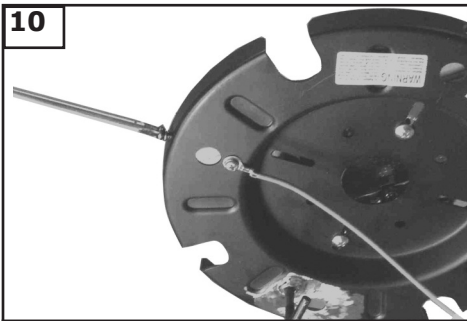

10
Loosen the two screws and washers across from each other on the ridge of the mounting plate. Remove the other two screws and lock washers. Save for later use.

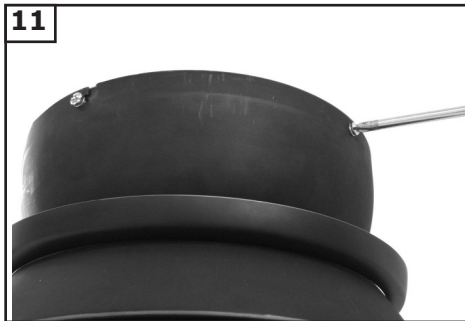

11
Lift the motor housing up aligning the L shape holes with the screws and washers on the mounting plate. Turn the housing clockwise to hold in position. Install the other two screws and washers previously removed securely.

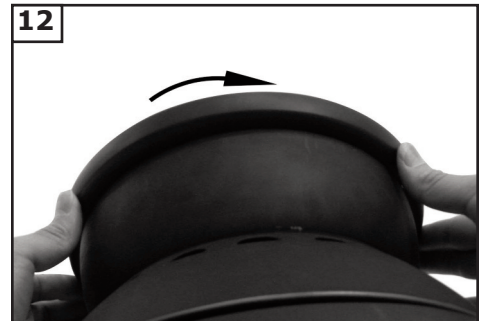

12
Lift the decorative ring up and twist clockwise till tight.

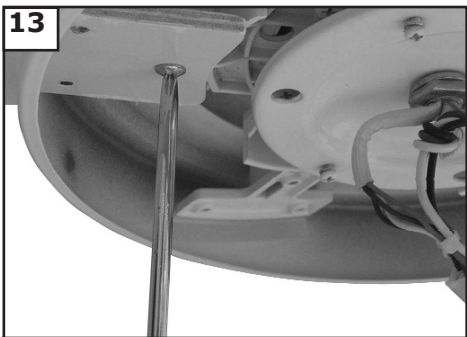

13
Check the motor for shipping stabilizers and remove if present. Attach blades using screws and washers in hardware pak. Tighten screws securely.



14
Loosen 2 screws and remove 1 screw from motor plate. Save removed screw for use later.



15
Install by twisting clockwise, add 1 screw removed step 14 to switch housing plate. Tighten the 3 screws securely.

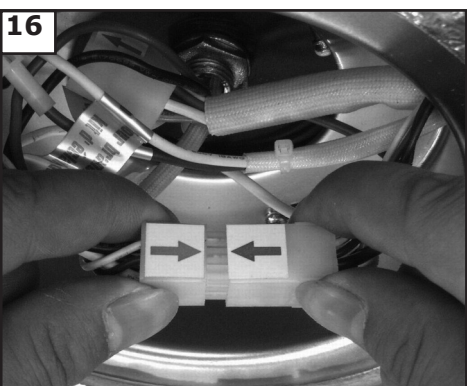

16
Connect plug from fan to switch house plug.

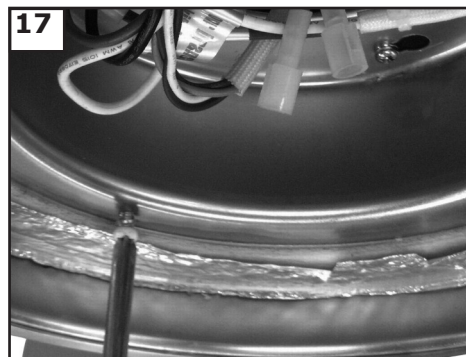

17
Loosen the pre installed screws of switch housing plate.

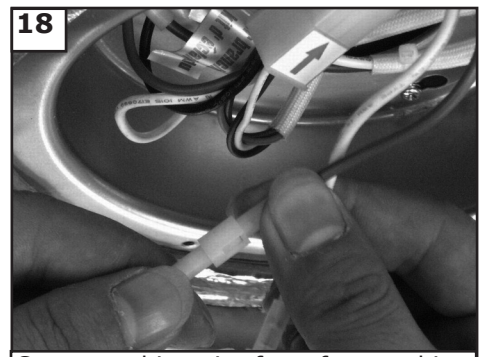

18
Connect white wire from fan to white wire from light fixture. Then plug blue wire from fan to black wire from light fixture.



19

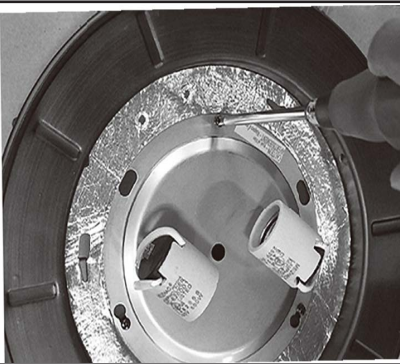

Install 3 screws to install light pan.

For fan with light kit go to step 20-21 to finish.

For fan without light kit go to step 22.

20



Install 2 x 9.3W medium base dimmable LED bulbs. California Title 24 compliant bulbs included.

Caution: Approved for use with LED light bulb only (Part No. 97502S). Do not use incandescent light bulb.
Caution: Do not replace bulb until it cools down.

21



Attach glass by locating dimples in light fixture with the grooves in glass and twisting clockwise till tight.

22



Attach the non light cover by locating dimples in the light fixture with the grooves in the non light kit cover and twist clockwise till tight. **WARNING:** Make sure light bulb is not installed when using this cover.



Trouble Shooting

If you have difficulty operating your new ceiling fan, it may be the result of incorrect assembly, installation, or wiring. In some cases, these installation errors may be mistaken for defects. If you experience any faults, please check this Trouble Shooting Chart. If a problem cannot be remedied, or you are experiencing difficulty in installation, please call our Customer Service Center at the number printed on your parts list insert sheet.

Warning: Before servicing or cleaning unit, Switch power off at Service panel and lock service disconnecting means to prevent power from being switched on accidentally. When the service disconnecting means cannot be locked, securely fasten a prominent warning device, such as a tag, to the service panel.

Trouble	Suggested Remedy
1. If fan does not start:	<ol style="list-style-type: none">1.Check main and branch circuit fuses or circuit breakers.2.Check line wire connections to fan and switch wire connections in switch housing. <p>CAUTION: Make sure main power is turned off.</p> <ol style="list-style-type: none">3.If this fan uses manual forward/reverse switch, make sure the switch is pushed firmly either way. Fan will not operate when switch is in the middle.4.If this fan uses remote controller, make sure dip switches are setting properly and make sure battery is effective.
2. If fan sounds noisy:	<ol style="list-style-type: none">1.Check to make sure all screws in motor housing are snug (not over tightened).2.Check to make sure the screws which attach the fan blade holder to the motor are tight.3.Check to make sure wire nut connectors in switch housing are not rattling against each other or against the interior wall of the switch housing. <p>CAUTION: Make sure main power is turned off before entering switch housing.</p> <ol style="list-style-type: none">4.Check to be sure light bulb is tight in socket and not touching the glass shade.5.Some fan motors are sensitive to signals from Solid State variable speed controls.6.Allow "break-in" period of 24 hours. Most noises associated with a new fan will disappear after this period.
3. If fan wobbles:	<ol style="list-style-type: none">1.If this is a downrod mount fan, make sure the ridge on mounting bracket engages the notch in the downrod ball.2.Make sure that canopy, mounting bracket or mounting plate are tightened securely to ceiling junction box and junction box is mounted firmly to ceiling joist.3.Check that all blades are screwed firmly into blade holders.4.Check that all blade holders are tightened securely to motor.5.Most fan wobble problems are caused when blade levels are unequal. Check this level by selecting a point on the ceiling above the tip of one of the blades. Measure this distance from blade tip to ceiling. Keeping measure within 1/8", rotate the fan until the next blade is positioned for measurement. Repeat for each blade. If all blade levels are not equal, you can adjust blade levels by the following procedure. To adjust a blade tip down, insert a washer (not supplied) between the blade and blade holder at the screw closest to the motor. To adjust a blade tip up, insert washer (not supplied) between the blade and blade holder at the two screws farthest from the motor. Reverse the position of the washer if blades mount from top of blade.6.If blade wobble is still noticeable, interchanging two adjacent (side by side) blades can redistribute the weight and possibly result in smoother operation. <p>If the above steps do not eliminate the wobble problem, you will need to dynamic balance your fan with balancing kit provided.</p>
4. If light does not work:	<ol style="list-style-type: none">1.Check blue wire from fan to make sure it is connected to hot wire from house.2.Check for loose or disconnected wires in fan switch housing.3.Check for loose or disconnected wires in light kit.4.Check for faulty light bulb and make sure bulb is tight in socket.5.Remove light kit and check the plug connections if they are present.6.If this fan uses remote controller, make sure dip switches are setting properly and make sure battery is effective. <p>CAUTION: Make sure main power is turned off before entering switch housing and/or canopy.</p>

Feb.2019 5TV42XXD-V1