

ENVisionLED™ LED TROFFER Installation Manual

INSTRUCTION MANUAL

PLEASE READ INSTRUCTIONS BEFORE INSTALLATION AND RETAIN FOR FUTURE REFERENCES. Electrical products can cause death or injury, or damage to property. If any doubt about the installation or use of this product, consult a professional electrician.

PRODUCT PARAMETERS

Part No.	Power	Working Current	Input Voltage	Luminous Efficacy	CCT	Viewing Angle	Ra	PF	Dimmable	Warranty
LED-CBT-2X2-5P40-5CCT	20/25/30/35/40W	0.367A	AC120-277V	125lm/W	3000K 3500K 4000K 5000K 6500K	120°	≥80	≥0.9	0-10V	5 Years
LED-CBT-2X4-5P50-5CCT	20/25/30/40/50W	0.458A								

PRODUCT DIMENSIONS

		2X2	2X4
Dimensions (inch)	L	23.74"	47.75"
	W	23.74"	23.74"
	H	2.08"	2.08"

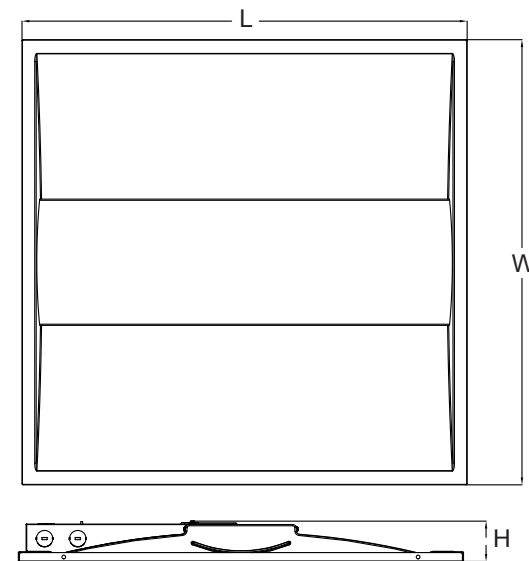

WARNING

- LED troffer are not suitable for using in wet loations.
- LED troffer are not suitable for covering with thermally insulating material.
- Please keep the LED troffer way from any corrosive substance, and please use dry cloth when you clean it.
- LED troffer can only be installed by a qualified electrician.
- Before installation or maintenance, please disconnect the power to prevent electric shock.

INSTALLATION GUIDE

1. Unscrew the driver cover.

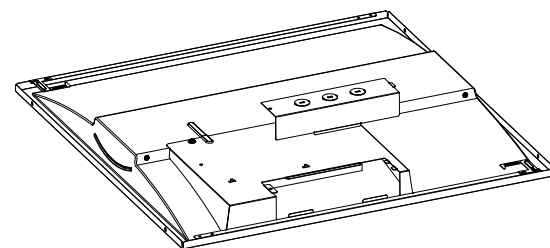

2. Connect the conduit to the driver box.

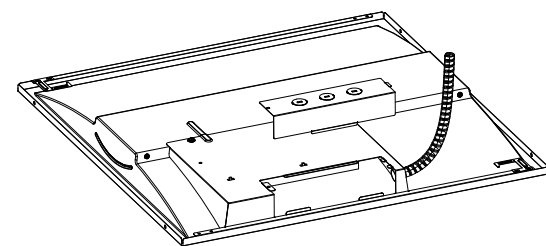

3. Connect other wires separately.

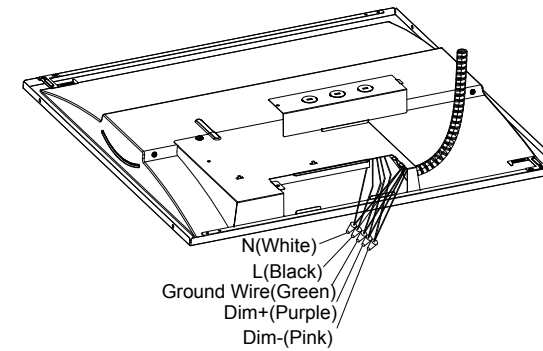

4. Put back the driver cover and fix by screw.

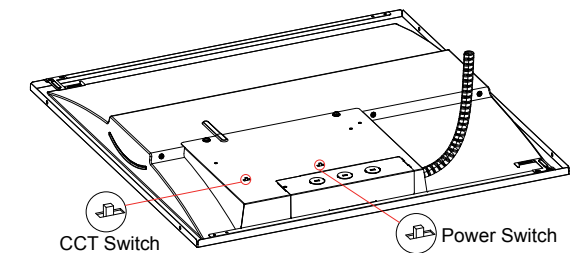

RECESSED DIMENSIONS

1. Replace existing lighting fixture from ceiling with LED troffer

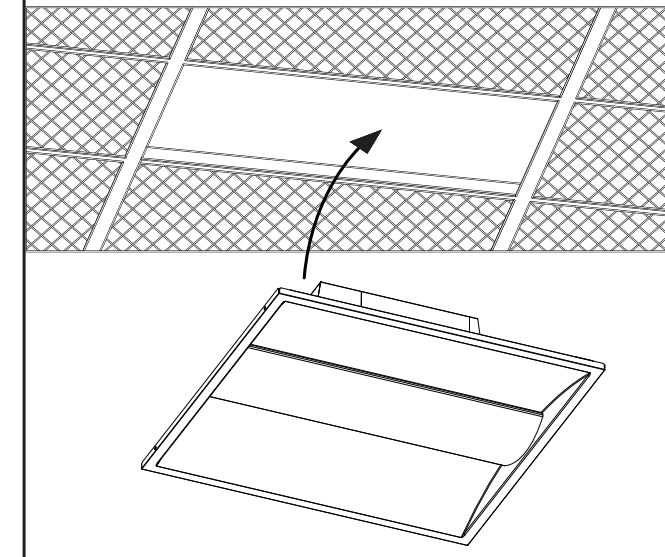

2. Place existing lighting fixture from ceiling with LED troffer

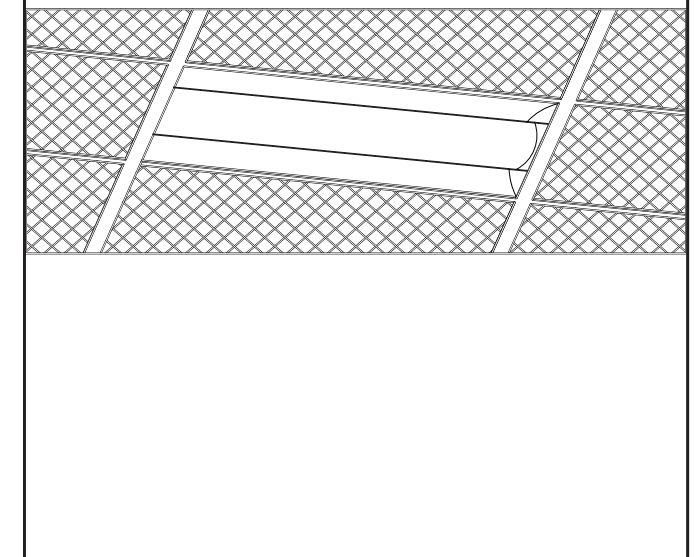

3. Use the protective brackets for safety

