

Internal-Line: Surface Mount LED Panels

Only 1.34" Thick!

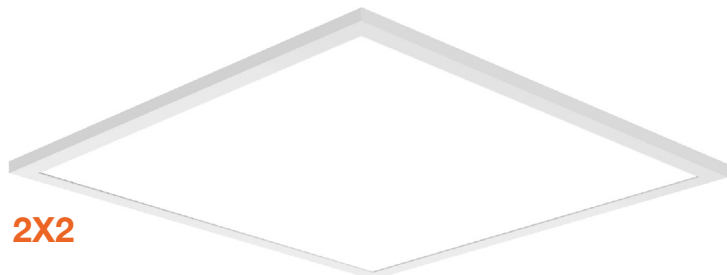

2X4



2X2



1X4

WATT	LUMENS
20	2,200
30	3,300
40	4,400
50	5,500

Detail Specifications:

- Finish: White, Custom finishes available
- IP Rating: Damp Location IP44
- Beam Angle: 110°
- Chip: SMD 2835, R9 >50, CRI >80
- Operating Temperature: -40° - 114° F
- Lens: PS diffuser
- Average life (L70) of 50,000 hours

Applications:

- General Indoor Lighting
- Utility & Storage
- Office and Meeting Rooms
- Education, Healthcare, Retail, Hospitality
- Residential and Commercial

Product Information:

- Aluminum housing finished with corrosion free powder coat
- Even light distribution
- Lightweight for easier installation
- Super slim only 1.34" thick!
- Select-n-Switch Technology: 5-CCT + 3-Power Selectable

Driver Options:

- 120-277V 0-10V Dimmable
- THD: <20% (+/-5% tolerance), PF >0.9, 50/60Hz
- Isolated Driver
- Flicker Free

Mounting & Installations:

- 30/40 Junction Box
- Surface mount bracket included

Certifications:

- UL Listed for USA and CA
- DLC Listed
- Approved for CA T24
- 5 Year Limited Warranty
- FCC CFR 47, GCC Part 15, Subpart B:2017

Series

LED-BPL-SM-2X2-3M40-5CCT

40/30/20W

LED-BPL-SM-1X4-3M40-5CCT

40/30/20W

LED-BPL-SM-2X4-3M50-5CCT

50/40/30W

Specs and model numbers are subject to change with or without notice. Customization of product is available.

FEATURES

Powder-Coated White Frame

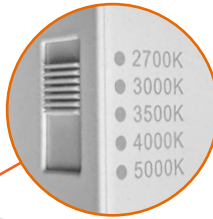

5-CCT Selectable

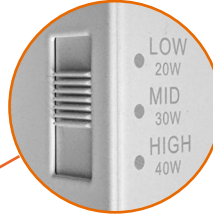

3 Watt Selectable

Unique Back-Lit Design

Only 1.34" Thick

Frosted Lens



2 Carabiner Safety Locks

DIMENSIONS

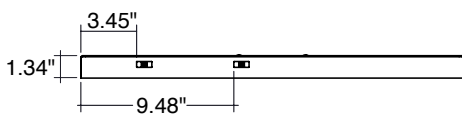
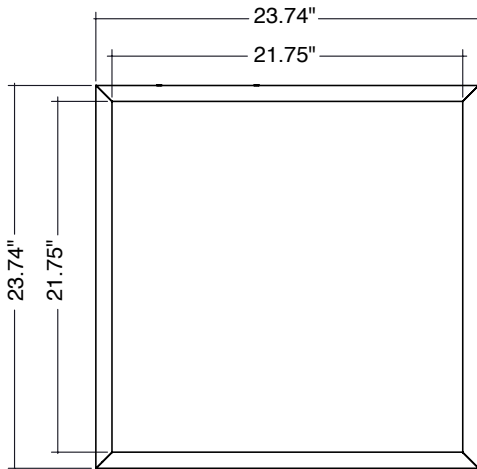

2X2

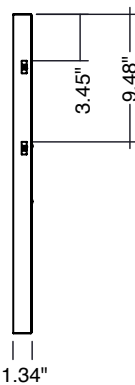

1.34"

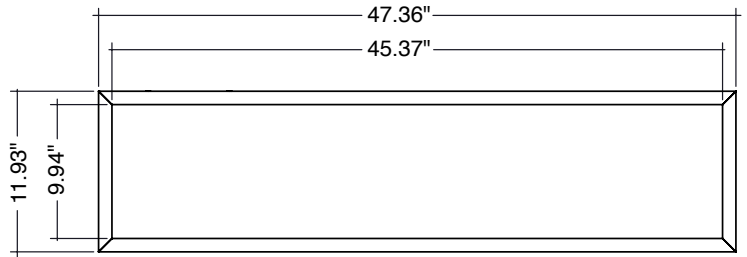

1X4

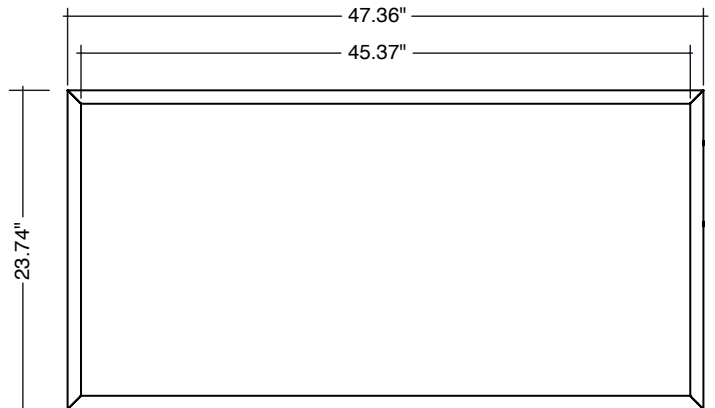

2X4