

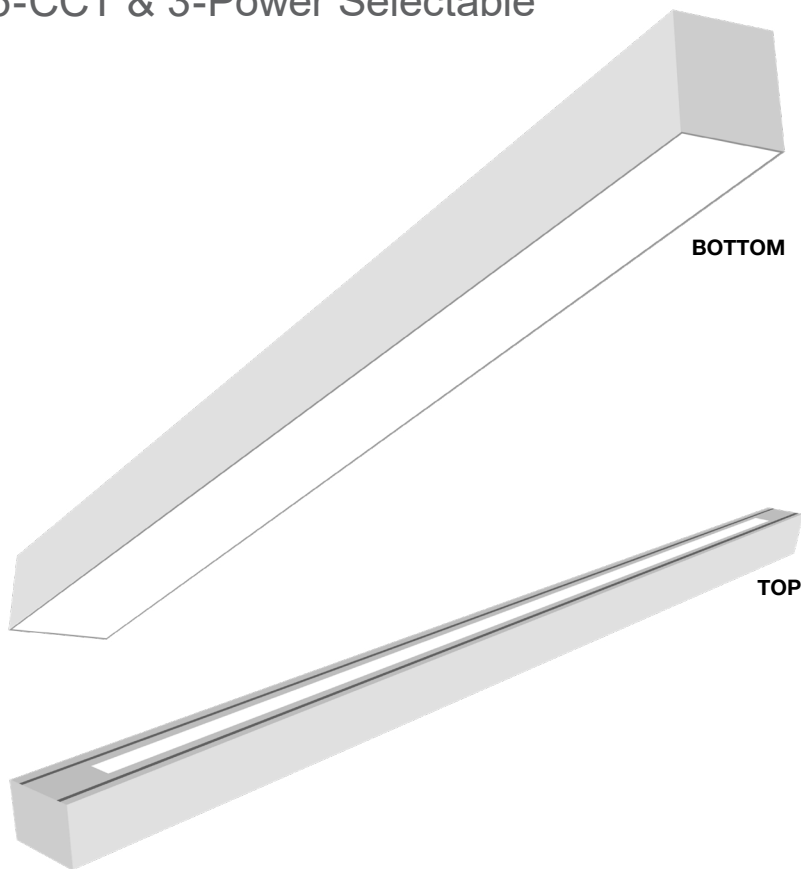

Arcy-Line: Architectural Linear Fixtures

5-CCT & 3-Power Selectable



BOTTOM

TOP

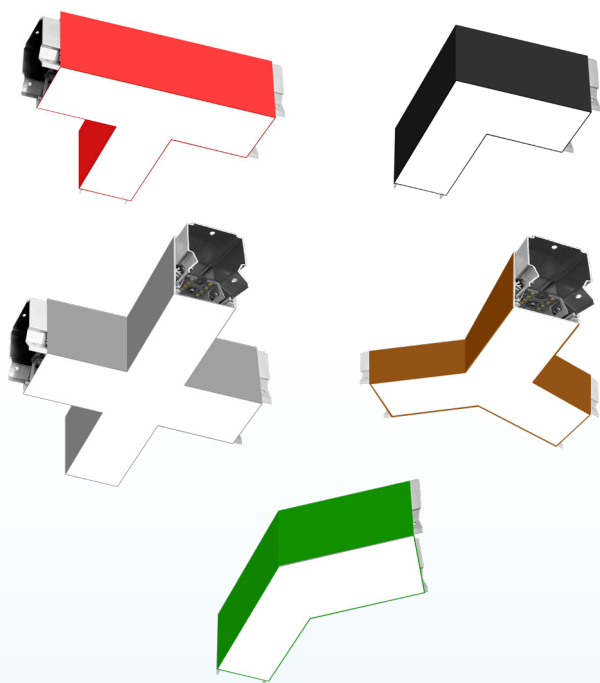

The ARCY-Line Direct/Indirect Architectural luminaires offer a 2" sleek and modern appearance with symmetrical light distribution. They can be surface, wall, recess, trimless, or pendant mounted. The luminaire provides flexible and creative illumination design options, including direct, indirect, and wall wash lighting, with fully illuminated corners for seamless connections between luminaires. It is designed to make an enduring impression in corporate offices, educational institutions, commercial spaces, and retail environments.

Detail Specifications:

- Finish: White, Custom finishes available
- IP Rating: Damp Location (IP44)
- Beam Angle: 100°
- Chip: SMD 2835, R9 >50, CRI >90
- Operating Temperature: -4° - 122° F
- Lens: Acrylic Frosted Lens Standard: efficiently emits the light through a high-quality acrylic lens, spreading it evenly and without causing glare
 - Optional Louver available
- Average life (L70) of 50,000 hours

Applications:

- Stairwell & Hallways
- Utility & Storage
- Garage Structures
- Office and Meeting Rooms
- Retail
- Commercial and Industrial

Product Information:

- Construction:
 - One piece aluminum extrusion housing that incorporates a precisely cut, smooth white extruded frosted lens that securely attaches to the body and allows easy removal for accessing the driver and LED boards when needed.
 - Soldi aluminum end caps are included
 - Finished with corrosion free powder coat.
- Fixture can be surface mounted or pendant mounted with 40 J-box cover included with every fixture
- Select-n-Switch Technology: 5-CCT + 3-Power Selectable

Driver Options:

- Max Run: 600W off one power feed
- UNV: 100-347V 0-10V Dimmable
- Optional 347-480V step down transformer available
- THD: <20% (+/-5% tolerance), PF >0.9, 50/60Hz
- 3-Power Selectable
- Flicker Free

Mounting & Installation:

- Fixture is pre-wired with wire harness that allows for easy daisy chain. No additional wiring is required for continuous run
- Bracket for continuous run is included
- 5-wire 6' power cord is included. 6-wire power cord is included with emergency models
- 6' Canopy suspension kit (1 power feed) included
- Surface mount: compatible with 30 or 40 j-box. Screws and connector included with each fixture.
- Wall, Recessed, Trimless, Flange Mount, Suspended all available. Details below.

Certifications:

- ETL Listed for USA and CA
- DLC Premium Listed
- Approved for CA T24
- 5 Year Limited Warranty
- FCC CFR 47, GCC Part 15, Subpart B:2017

Specs and model numbers are subject to change with or without notice

ORDERING GUIDE

LINEAR MODELS

Series	Length & Wattage	Light Direction	CCT	Finish ¹	Sensor	Emergency	Mounting Options
LED-ALIN2 Architectural Linear	1FT-3P12 12/9/6W 2FT-3P25 25/19/13W 4FT-3P50 50/38/25W 6FT-3P75 75/56/38W 8FT-3P100 100/75/50W	D Downlight UD Downlight & Uplight (View Chart for Lumens/Wattage)	5CCT 50/40/35 30/27K	WH White BL ¹ Black SLV ¹ Silver CS ¹ Custom Color ¹	(blank) BMS Microwave Bi-Level Motion + Daylight Sensor	(blank) EMB Emergency Backup WML Side Wall Mount Brackets Installed to fixture. Left side wire entry. FLNG2 Recessed drywall kit will be added to the 2 long (length) of the fixture. Choose this option for the fixtures in the middle.	(blank) WMR Side Wall Mount rackets Installed to fixture. Right side wire entry. TML Trimless kit will be added to all 4 sides of the fixture. Choose this option for standalone fixtures. TML2 Trimless kit will be added to the 2 long (length) of the fixture. Choose this option for the fixtures in the middle.
				1. White finish standard. Other colors are made to order appx. 15 days.			FLNG3 Recessed drywall kit will be added to the 2 long (length) and 1 short (width) of the fixture. Choose this option for the first and last fixtures on a run. TML3 Trimless kit will be added to the 2 long (length) and 1 short (width) of the fixture. Choose this option for the first and last fixtures on a run.

SPECIAL SHAPE MODELS

Series	Shape & Wattage	Light Direction	CCT	Finish ¹	Sensor	Emergency	Mounting Options
LED-ALIN2 Architectural Linear	12X12-L-3P25 L-Shape 25/19/13w 12X12-120L-3P25 120° L-Shape 25/19/13w 24X24-L-3P50 L-Shape 50/38/25w 22x10-T-3P36 T-Shape 36/25/17w 22X22-X-3P50 X-Shape 50/38/25w	D Downlight UD Downlight & Uplight (View Chart for Lumens/Wattage)	5CCT 50/40/35 30/27K	WH White BL ¹ Black SLV ¹ Silver CS ¹ Custom Color ¹	(blank) BMS Microwave Bi-Level Motion + Daylight Sensor	(blank) EMB Emergency Backup	(blank) FLNG Recessed drywall kit will be added to all 4 sides of the fixture. Choose this option for stand alone fixtures. TML Trimless kit will be added to all 4 sides of the fixture. Choose this option for standalone fixtures.
				1. White finish standard. Other colors are made to order appx. 15 days.			

CONNECTORS

Connectors	CCT	Finish ¹	Mounting Options
LED-ALIN2-L-5CCT 8" L-Shape Connector	5CCT 50/40 35/30	WH White	FLNG Recessed drywall kit will be added to all sides of the fixture.
LED-ALIN2-X-5CCT 8" X-Shape Connector	27K	BL ¹ Black	TML Trimless kit will be added sides of the fixture.
LED-ALIN2-Y-5CCT 8" Y-Shape Connector		SLV ¹ Silver	
LED-ALIN2-120L-5CCT 8" 120° L-Shape Connector		CS ¹ Custom Color	
		1. White finish standard. Other colors are made to order appx. 15 days.	

ACCESSORIES

Suspension Canopy Kits	Suspension Rod Pendant Kits (Non-Adjustable)	Optional Installation Brackets	Flange (Drywall) Kit	Trimless Kit	Up Light Kit (Field Installable)
SK-CPR-20FT-1WR-WH 20' Single Wire White Finish	ALIN2-6FT-SRK-WH 6' White Finish	ALIN2-WM Wall Mounting Brackets. Order 1 set for every 4 feet.	ALIN2-RTK-2FT ALIN2-RTK-4FT ALIN2-RTK-6FT ALIN2-RTK-8FT	ALIN2-TML-2FT ALIN2-TML-4FT ALIN2-TML-6FT ALIN2-TML-8FT	ALIN2-2FT-UL 5/4/2.5w ALIN2-4FT-UL 10/8/5w
SK-CPR-20FT-1WR-BL 20' Single Wire Black Finish	ALIN2-6FT-SRK-BL 6' Black Finish	ALIN2-RB Recessed Bracket. Order 1 set for every 4 feet.			

Specs and model numbers are subject to change with or without notice

ORDERING GUIDE

MAXIMUM RUN BY FOOT	
POWER SETTING	600W Max
LOWEST	96 Feet
MIDDLE	64 Feet
HIGHEST	48 Feet

WATTAGE BY FOOT	
POWER SETTING	
LOWEST	6.25W
MIDDLE	9.38 W
HIGHEST	12.5 W

LUMENS CHART BY FOOT

DOWNLIGHT ONLY LUMENS/FT.	
POWER SETTING	DOWNLIGHT
LOWEST	750
MIDDLE	1,125
HIGHEST	1,500

DOWNLIGHT & UP LIGHT LUMENS/FT.		
POWER SETTING	DOWNLIGHT	UP LIGHT
LOWEST	600	150
MIDDLE	900	240
HIGHEST	1,200	300

LUMENS CHART BY FIXTURE

3P12 MODELS					
DOWNLIGHT ONLY FIXTURE		DOWNLIGHT & UP LIGHT FIXTURE			
DOWNLIGHT		DOWNLIGHT		UP LIGHT	
WATT	LUMENS	WATT	LUMENS	WATT	LUMENS
6	750	5	600	1	120
9	1,080	7	840	2	240
12	1,500	9.5	1,200	2.5	300

3P25 MODELS					
DOWNLIGHT ONLY FIXTURE		DOWNLIGHT & UP LIGHT FIXTURE			
DOWNLIGHT		DOWNLIGHT		UP LIGHT	
WATT	LUMENS	WATT	LUMENS	WATT	LUMENS
13	1,560	10	1,200	3	360
19	2,280	15	1,800	4	480
25	3,000	20	2,400	5	600

3P50 MODELS					
DOWNLIGHT ONLY FIXTURE		DOWNLIGHT & UP LIGHT FIXTURE			
DOWNLIGHT		DOWNLIGHT		UP LIGHT	
WATT	LUMENS	WATT	LUMENS	WATT	LUMENS
25	3,000	20	2,400	5	600
37.5	4,500	30	3,600	8	960
50	6,000	40	4,800	10	1,200

3P75 MODELS					
DOWNLIGHT ONLY FIXTURE		DOWNLIGHT & UP LIGHT FIXTURE			
DOWNLIGHT		DOWNLIGHT		UP LIGHT	
WATT	LUMENS	WATT	LUMENS	WATT	LUMENS
38	4,560	30	5,040	8	600
56	6,720	45	5,400	11	1,320
75	9,000	60	7,200	15	1,200

3P100 MODELS					
DOWNLIGHT ONLY FIXTURE		DOWNLIGHT & UP LIGHT FIXTURE			
DOWNLIGHT		DOWNLIGHT		UP LIGHT	
WATT	LUMENS	WATT	LUMENS	WATT	LUMENS
50	9,000	40	4,800	10	1,200
75	9,000	60	7,200	15	1,800
100	12,000	80	9,600	20	2,400

Lumen based off 4000K. Other CCT: +/- 5%

Specs and model numbers are subject to change with or without notice

EnVision LED Lighting, Inc.

6023 Bandini Blvd. | Bell, CA 90040 | Tel.: 323-604-0066 | www.envisionledlighting.com

INSTALLATION METHODS

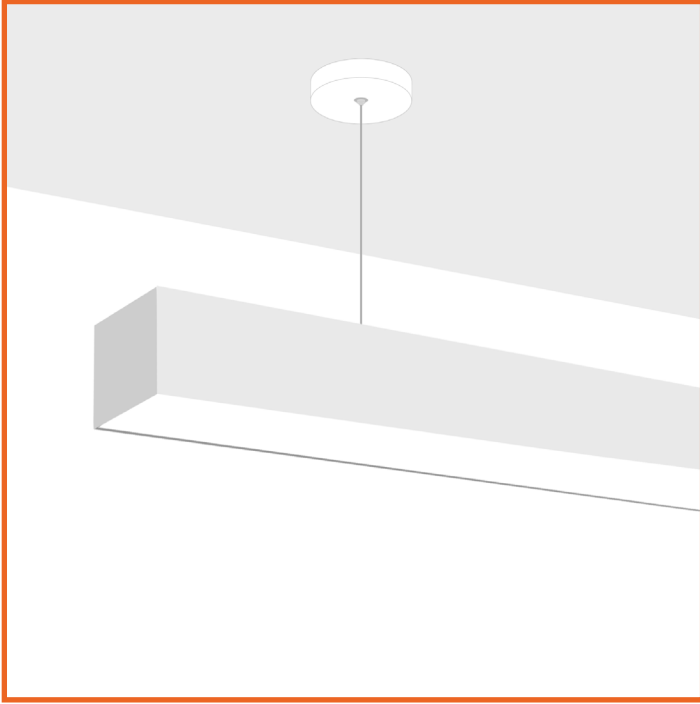

Suspension (Wire)

Each fixture includes a 6' suspension canopy kit. The suspension kit can be adjusted in length. Painted Fixtures: 6' canopy kit for any custom painted fixture will also be painted to the matching RAL of the body unless otherwise noted. Optional 12' canopy kit available in white or black finish.



MODEL #
SK-12FT-CPR-1WR-WH
SK-12FT-CPR-1WR-BL

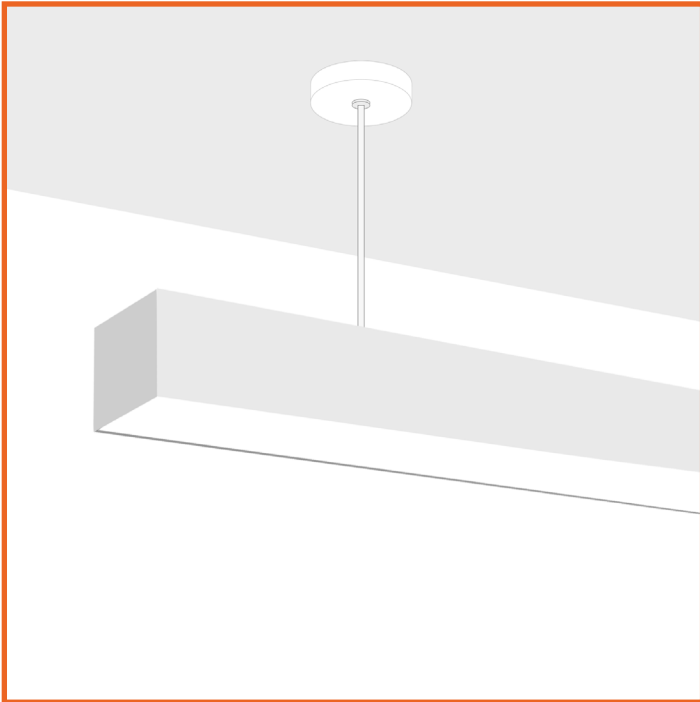

Suspended (Stem/Rod Kit)

Suspend each fixture with a stem rod kit that can be adjusted to 2' or 4'. Available standard in white or black finish. Other paint options are available.



MODEL #
ALIN2-2/4FT-SRK-WH
ALIN2-2/4FT-SRK-BL

Specs and model numbers are subject to change with or without notice

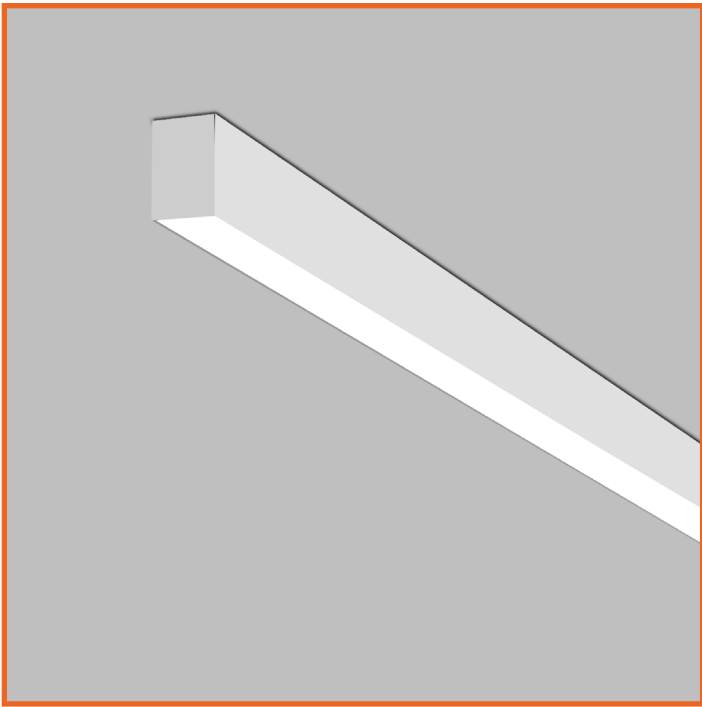

Surface Mounted

Surface mount kit accessories are included in the box. 40 j-box cover is included. Do not surface mount fixtures with up-light.

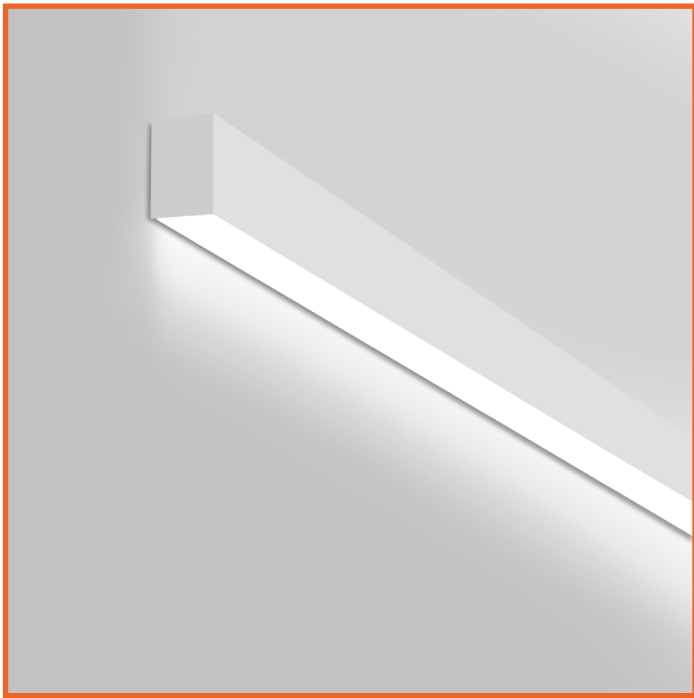

SHOWN WITH WALL MOUNT

Wall Mount (Factory Install Only)

Wall mounting brackets must be installed at the factory level. Drilling into the side of the fixture will be required. Specify on your order:

- WML**: power feed will be added to the left side of the fixture.
- WMR**: power feed will be added to the right side of the fixture.

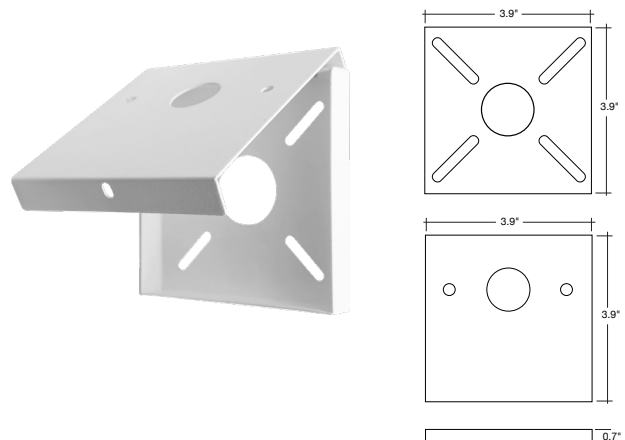

Specs and model numbers are subject to change with or without notice



Recessed Drywall Flange Kit (Factory Install Only)

Drywall recessed flange kit must be installed at the factory level. Bracket will allow for recessed and flush installation into drywall or other hard ceiling applications. Specify on your order:

- RTK:** Trim will be installed to all 4 corners of the fixture. Ideal for stand-alone fixtures.
- RTK2:** Trim will be installed to the 2 long (length) sides of the fixture. Ideal for middle fixtures in a continuous run.
- RTK3:** Trim will be installed to the 2 long (length) and 1 short (width) of the fixture. Ideal for the start or end of a continuous run. Recessed bracket will be included with each fixture.

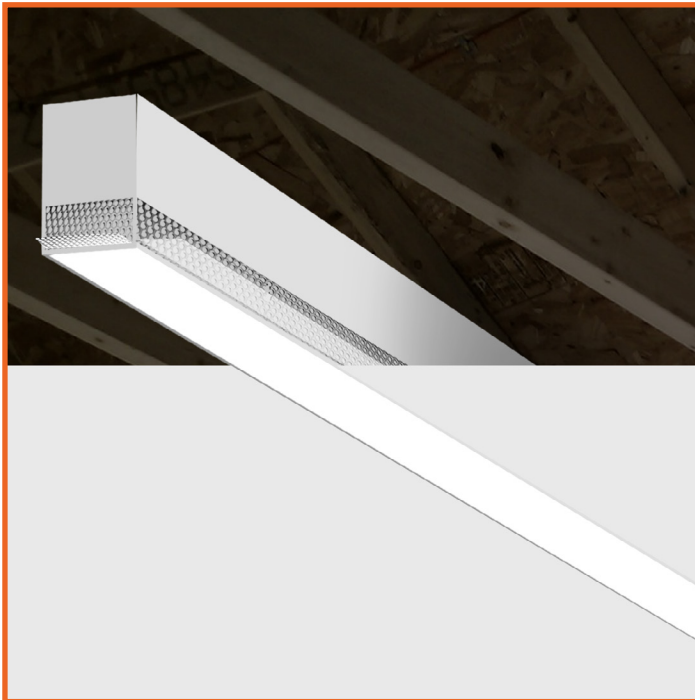
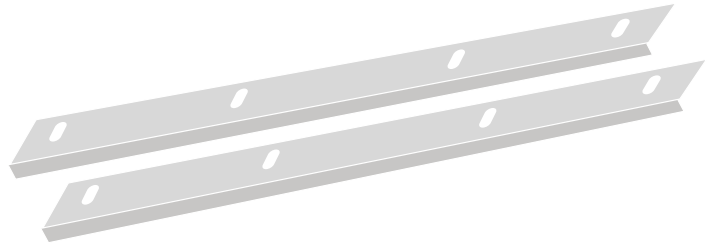

Trimless Recessed Kit (Factory Install Only)

Bracket will allow for trimless/mud-in installation. Bracket will add a 1/16" spacing from the lens to allow room for the mud in.

- TML:** Trim will be installed to all 4 corners of the fixture. Ideal for stand-alone fixtures.
- TML2:** Trim will be installed to the 2 long (length) sides of the fixture. Ideal for middle fixtures in a continuous run.
- TML3:** Trim will be installed to the 2 long (length) and 1 short (width) of the fixture. Ideal for the start or end of a continuous run. Recessed bracket will be included with each fixture.

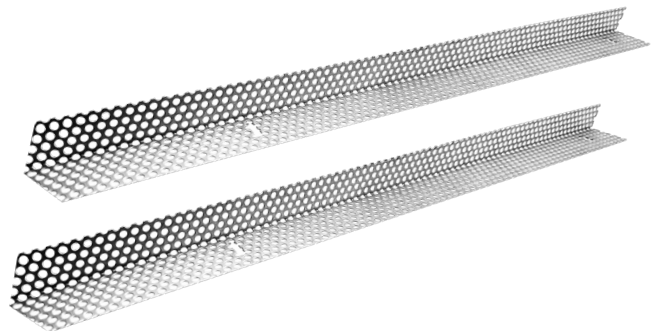

RECESSED TRIMLESS

Specs and model numbers are subject to change with or without notice

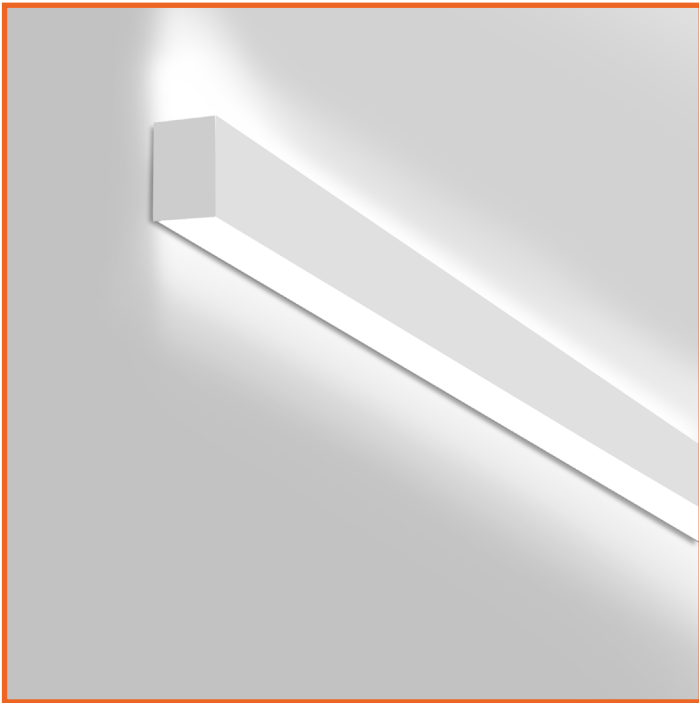

Up Light Kit

Model #'s: ALIN2-2FT-UL, ALIN2-4FT-UL

This option can be field installed but is recommended to be factory installed. Up light is only available on fixtures 2' + length. Ordering guide for field install or stock check:

MODEL #	UP LIGHT MODEL #
LED-ALIN2-2FT-3P25	Qty 1: ALIN2-2FT-UL
LED-ALIN2-4FT-3P50	Qty 1: ALIN2-4FT-UL
LED-ALIN2-6FT-3P75	Qty 1: ALIN2-2FT-UL Qty 1: ALIN2-4FT-UL
LED-ALIN2-8FT-3P100	Qty 2: ALIN2-4FT-UL
LED-ALIN2-24X24-L-3P50	Qty 2: ALIN2-2FT-UL
LED-ALIN2-22X10-T-3P36	Qty 2: ALIN2-2FT-UL
LED-ALIN2-22X22-X-3P50	Qty 2: ALIN2-2FT-UL

DIMENSIONS

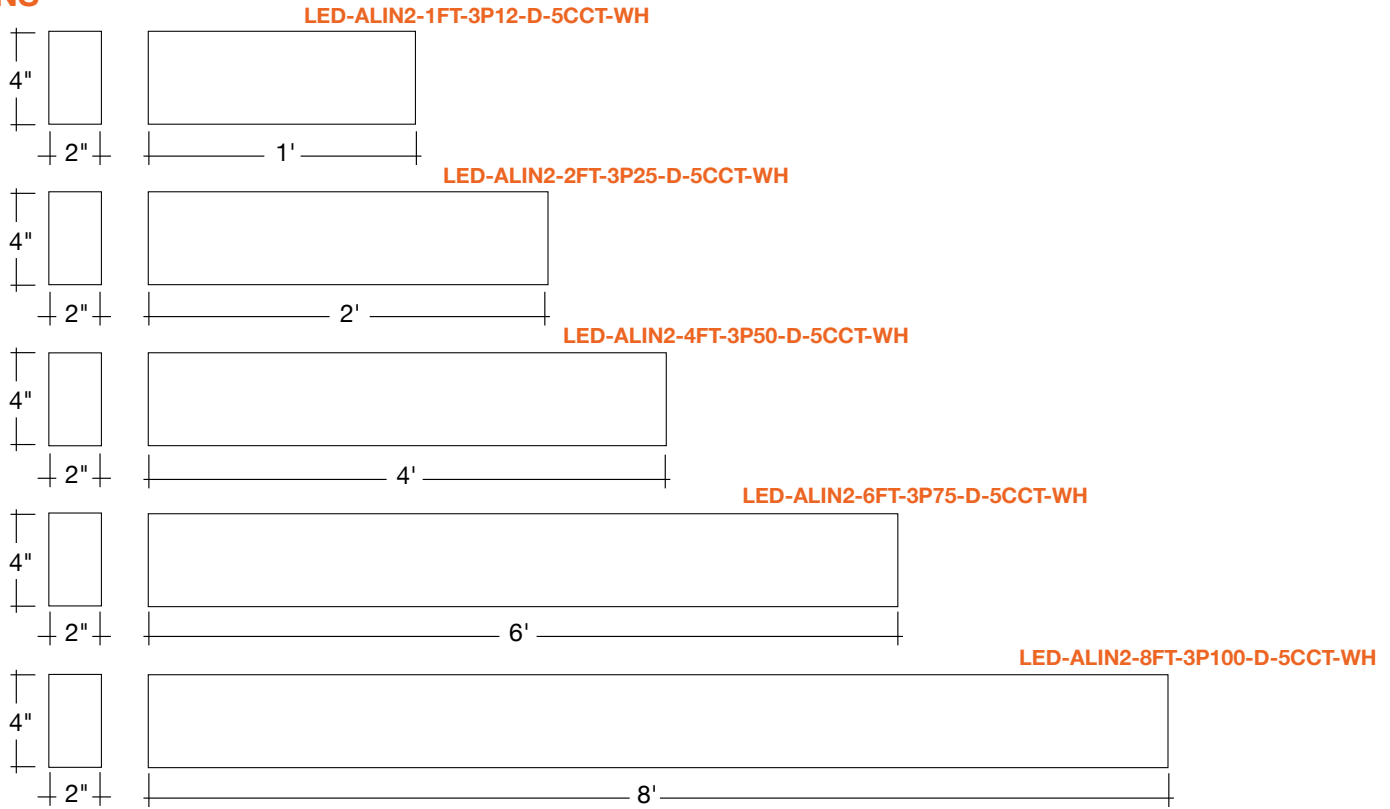

DIMENSIONS

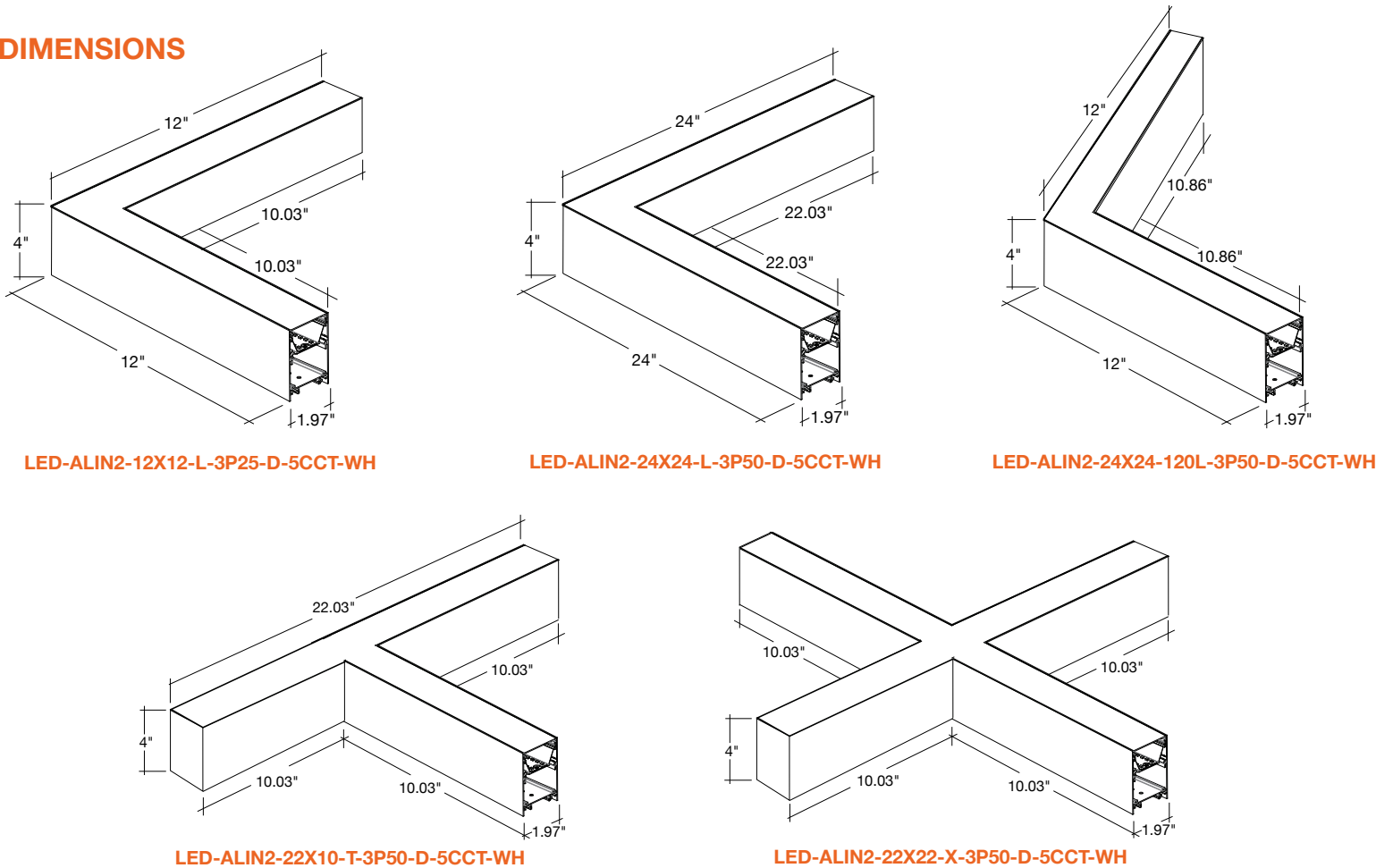

DIMENSIONS

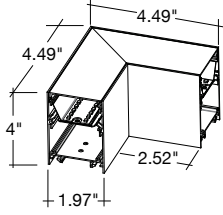

LED-ALIN2-L-D-5CCT-WH

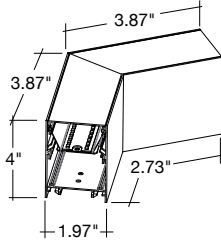

LED-ALIN2-120L-D-5CCT-WH

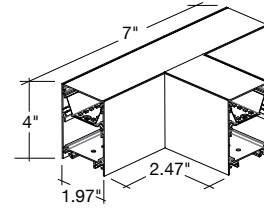

LED-ALIN2-2FT-T-3P50-UD-5CCT-WH

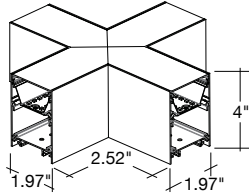

LED-ALIN2-X-D-5CCT-WH

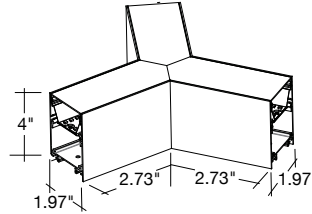

LED-ALIN2-Y-D-5CCT-WH

2X2

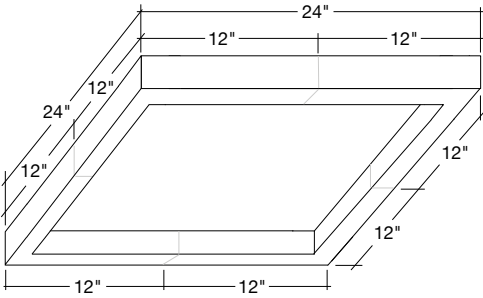

2' X 2' SQUARE	QTY.
LED-ALIN2-12X12-L-3P25-D-5CCT-WH	4

3X3

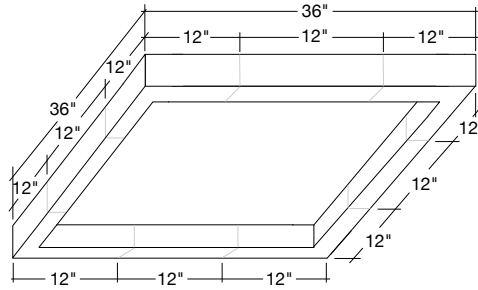

3' X 3' SQUARE	QTY.
LED-ALIN2-12X12-L-3P25-D-5CCT-WH	4
LED-ALIN2-12-I-3P12.5-D-5CCT-WH	4

4X4

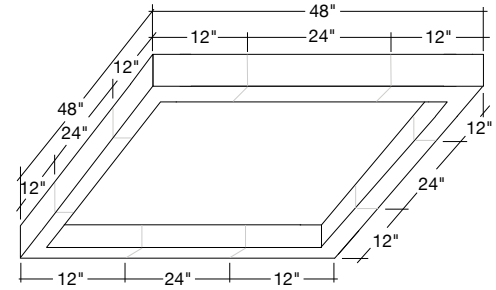

4' X 4' SQUARE	QTY.
LED-ALIN2-12X12-L-3P25-D-5CCT-WH	4
LED-ALIN2-24-I-3P25-D-5CCT-WH	4

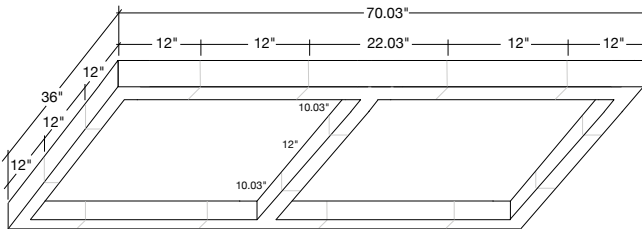

3' X 3' (2) SQUARE	QTY.
LED-ALIN2-12X12-L-3P25-D-5CCT-WH	4
LED-ALIN2-12-I-3P12.5-D-5CCT-WH	6
LED-ALIN2-22X10-T-3P50-D-5CCT-WH	2

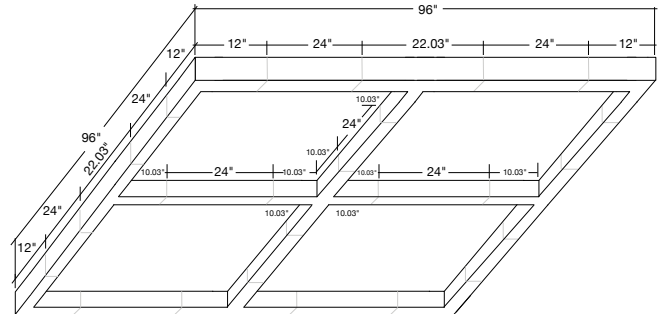

3' X 3' (4) SQUARE	QTY.
LED-ALIN2-12X12-L-3P25-D-5CCT-WH	4
LED-ALIN2-24-I-3P25-D-5CCT-WH	10
LED-ALIN2-22X10-T-3P50-D-5CCT-WH	4
LED-ALIN2-24X24-X-3P50-D-5CCT-WH	1

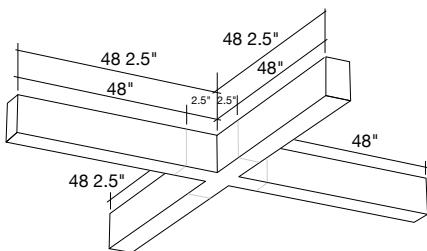

8' X 8' (X SHAPE)	QTY.
LED-ALIN2-48-I-3P50-D-5CCT-WH	4
LED-ALIN2-X-D-5CCT-WH	1

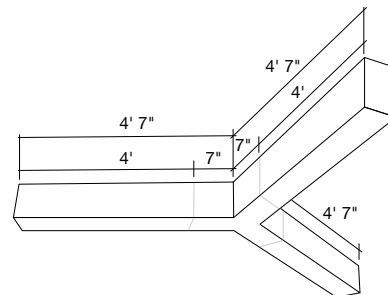

4' X 4' X 4' (Y SHAPE)	QTY.
LED-ALIN2-48-I-3P50-D-5CCT-WH	3
LED-ALIN2-Y-D-5CCT-WH	1

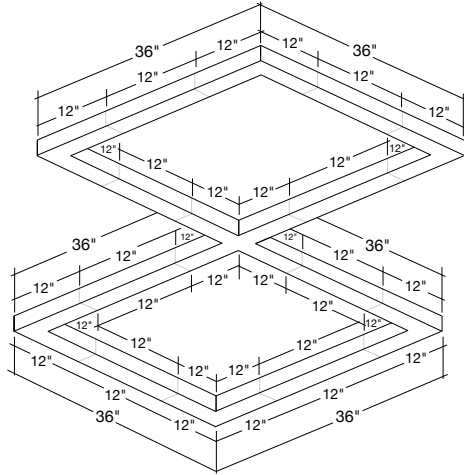

3' X 3' (2) SQUARE	QTY.
LED-ALIN2-12X12-L-3P25-D-5CCT-WH	6
LED-ALIN2-12-I-53P12.5-D-5CCT-WH	8
LED-ALIN2-24X24-X-3P50-D-5CCT-WH	1

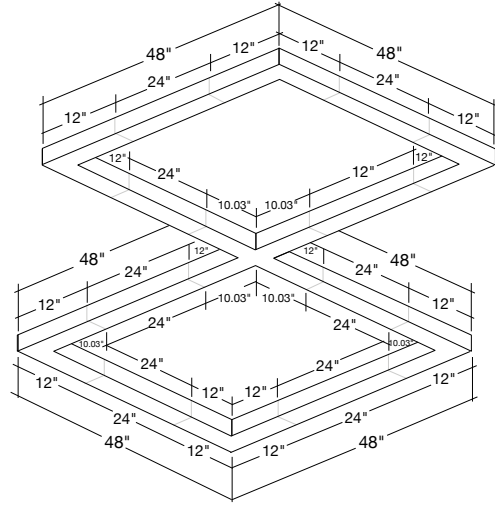

4' X 4' (2) SQUARE	QTY.
LED-ALIN2-12X12-L-3P25-D-5CCT-WH	6
LED-ALIN2-24-I-3P25-D-5CCT-WH	8
LED-ALIN2-24X24-X-3P50-D-5CCT-WH	1

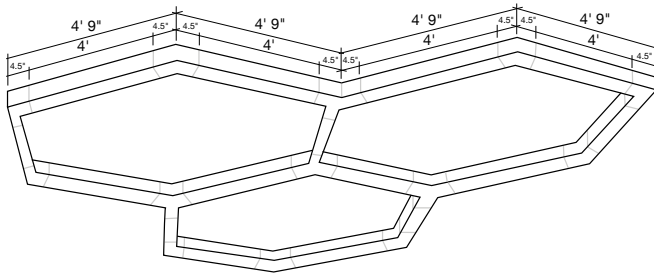

3' X 3' (3) TRIPLE OCTAGON	QTY.
LED-ALIN2-120L-D-5CCT-WH	9
LED-ALIN2-48-I-3P50-D-5CCT-WH	15
LED-ALIN2-Y-D-5CCT-WH	4

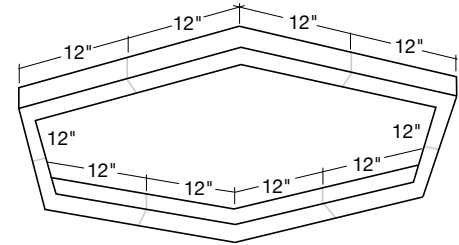

2' OCTAGON	QTY.
LED-ALIN2-12X12-120L-D-5CCT-WH	6

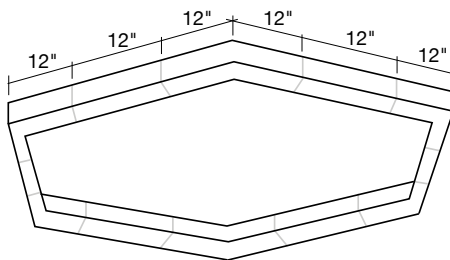

3' OCTAGON	QTY.
LED-ALIN2-12X12-120L-D-5CCT-WH	6
LED-ALIN2-12-I-3P12.5-D-5CCT-WH	6

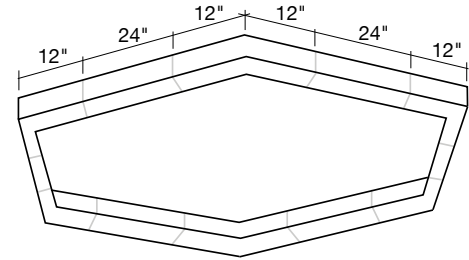

4' OCTAGON	QTY.
LED-ALIN2-12X12-120L-D-5CCT-WH	6
LED-ALIN2-24-I-3P25-D-5CCT-WH	6

Specs and model numbers are subject to change with or without notice