

LED Commercial Growlight

FULL SPECTRUM



FEATURES

- Adjust power for any stage of plant life
- Linkable connector to daisy chain multiple lights included
- 10 foot power cord
- 6 foot suspension kit included
- Energy saving LED technology
- Features 8 LED bars compared to industry standard of 6
- Ideal for cannabis growing use

- INPUT: AUTO 120-277V**
- IP65 RATED**
- FULL SPECTRUM LED**
- BUILT-IN POWER CONTROL KNOB**
- 0-10V DIMMABLE FOR CONTROL COMPATIBILITY**



Series
QB-FSG-8B-7T

Watts
 -
660W
 1716 μ Mols / 2.6 μ Mol/J
960W
 2496 μ Mols / 2.6 μ Mol/J

Specs and model numbers are subject to change with or without notice

Jumper cables allow for attached multiple fixtures together

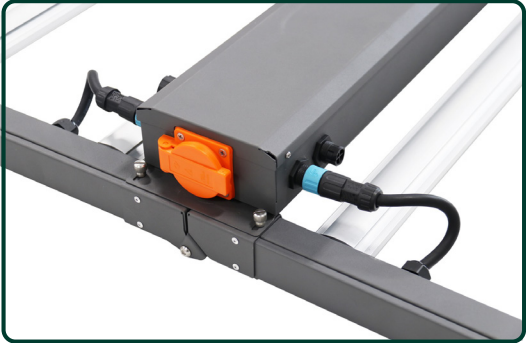

Power control knob allows you to adjust the power for any stage of plant life



8 bar design allows for more power, even light distribution, better heat dissipation, and longevity



Full spectrum LED chips for cannabis use



Foldable design for better handling

660W

OPTICAL	Input Power (Tolerance: $\pm 10\%$)	960W
	Photosynthetic photon flux (Tolerance: $\pm 10\%$)	1716 $\mu\text{mol/s}$
	Luminous Efficacy (Tolerance: -5%)	2.6 $\mu\text{mol/J}$
	Viewing Angle (Tolerance: $\pm 10\%$)	120°
	Spectrum	Full Spectrum Greenhouse Spectrum Indoor Spectrum
	CRI	>80
ELECTRICAL	Input Voltage	120-277VAC 50/60Hz
	PF	≥ 0.9
	THD	$\leq 20\%$
	Driver Brand	China brand driver
	Driver Surge Protection	L/N-PE: 10kV, L-N: 5kV
	Dimming	0-10V Dimming Standard
MATERIALS	LED Brand	China brand LEDs (White, Red)
	Housing	Aluminum Alloy
	Housing Color	Silver
	Waterproof Rating	Damp
OTHERS	Operating Temperature	-40 to 50
	Operating Humidity	10 -90 RH
	Storage Temperature	-40 to 80
	Storage Humidity	10 -95 RH
	Warranty Time	5 Year Warranty

SPECTRUM

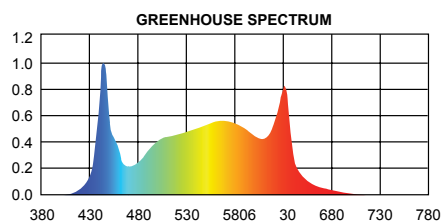
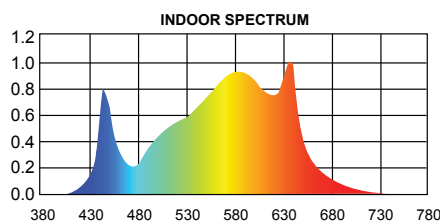
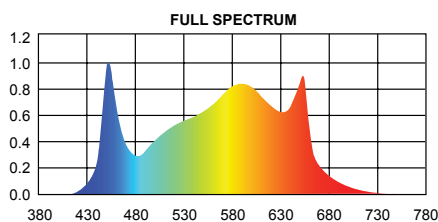

960W

OPTICAL	Input Power (Tolerance: $\pm 10\%$)	960W
	Photosynthetic photon flux (Tolerance: $\pm 10\%$)	2596 $\mu\text{mol/s}$
	Luminous Efficacy (Tolerance: -5%)	2.6 $\mu\text{mol/J}$
	Viewing Angle (Tolerance: $\pm 10\%$)	120°
	Spectrum	Full Spectrum Greenhouse Spectrum Indoor Spectrum
	CRI	>80
ELECTRICAL	Input Voltage	120-277VAC 50/60Hz
	PF	≥ 0.9
	THD	$\leq 20\%$
	Driver Brand	China brand driver
	Driver Surge Protection	L/N-PE: 10kV, L-N: 5kV
	Dimming	0-10V Dimming Standard
MATERIALS	LED Brand	China brand LEDs (White, Red)
	Housing	Aluminum Alloy
	Housing Color	Silver
	Waterproof Rating	Damp
OTHERS	Operating Temperature	-40 to 50
	Operating Humidity	10 -90 RH
	Storage Temperature	-40 to 80
	Storage Humidity	10 -95 RH
	Warranty Time	5 Year Warranty

SPECTRUM

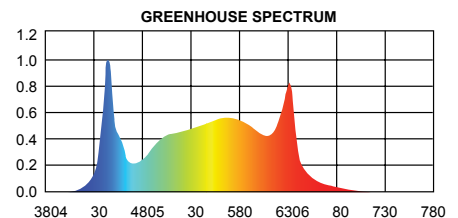
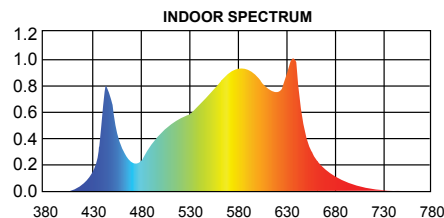
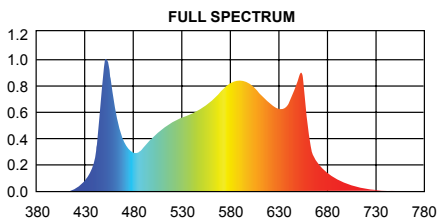

660W

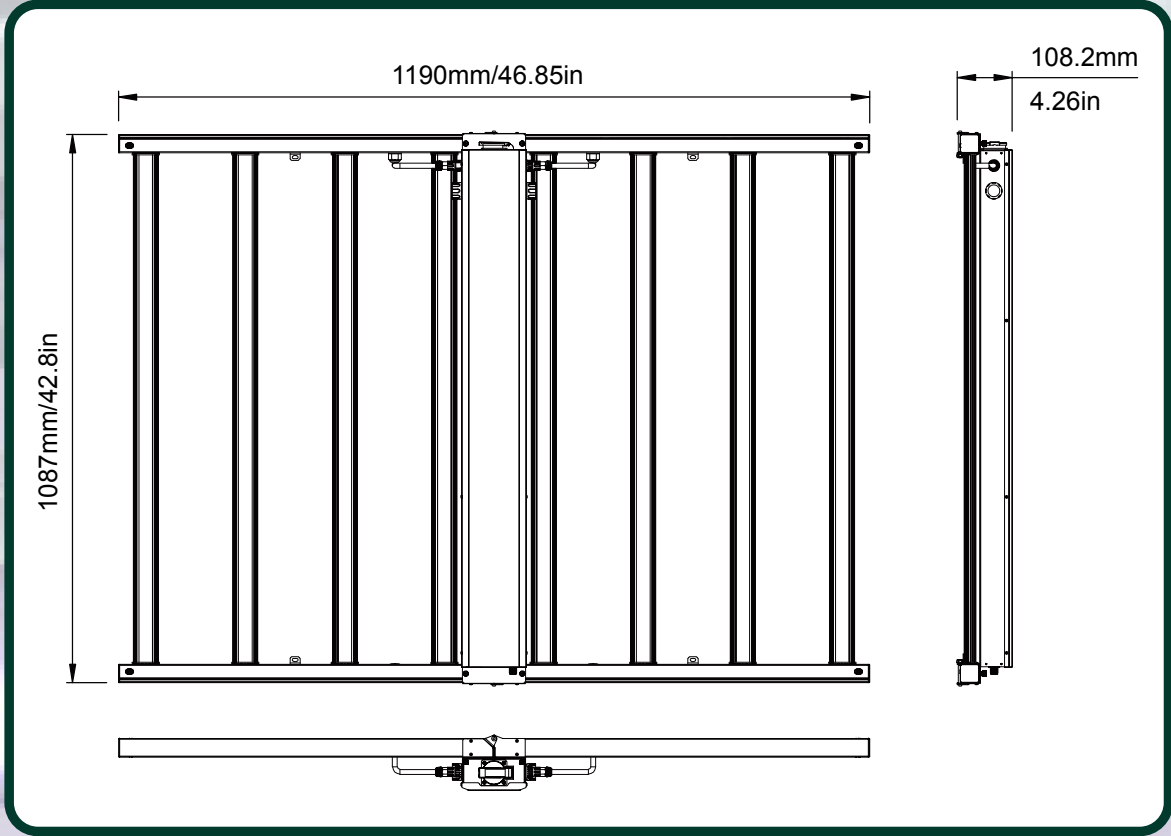

960W

