

Installation Instructions

Cautions:

1. Do not use any electric generator to test this LED light.
2. Please abide by related country, regional and local law and regulations when installing this fixture.
3. Please turn off the power before installation or maintenance.
4. Proper earth grounding is required to ensure safety.
5. Make the lighting facing downward vertically after installation

Notice:

1. To avoid possibility of electrical shock or fire, the installation personnel must have professional electric knowledge.
2. Please wear gloves to avoid injury before installation.
3. If any smoke or spark of the wire happened, please turn off the power immediately and notify relevant personnel.

Attention:

1. Please check if there is any damage during shipping. If so, please contact manufacturer timely.
2. Please read the installation instruction carefully to check whether all the accessories are present. After confirmation, install the fixture according to installation steps.

Instructions:

1. This product has dimming function.
2. 3 dimming functions are available in this LED light.
 - (1). Constant current can be achieved by 0-10VDC or 1-10VDC dimming.
 - (2). PWM signal dimming.
 - (3). Variation of resistance unit dimming (Please choose the appropriate dimming way according to your needs. You can also choose not to use this function).
3. Choose the wire connection ways, dimming ways and installation ways according to your needs and the led fixture purchased.

Wiring Diagram:

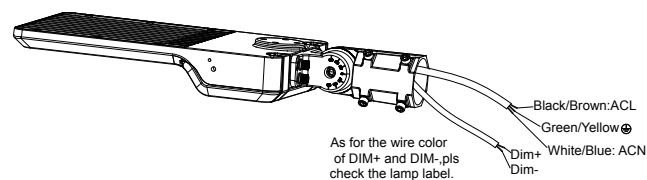

Optional Brackets and Installation Instructions

There are 5 optional brackets for this fixture. The following is shoebox fixtures with different brackets.

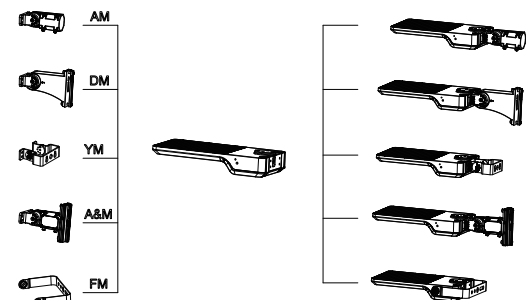

Installation Instructions with different brackets

1. ADJUSTABLE FITTER MOUNTING (e=AM)

- Step 1: Remove the bracket mounting screws on the fixture and pass the wires through the bracket. (Figure 1)
- Step 2: Install the bracket on the fixture. (Figure 2)

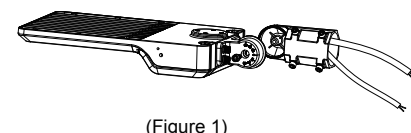

(Figure 1)

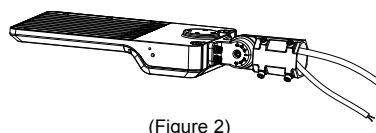

(Figure 2)

2. DIRECT MOUNTING (e=DM)

- Step 1: Remove the bracket mounting screws on the fixture, open the side lid of bracket and pass the wires through the bracket. (Figure 3)
- Step 2: Install the bracket on the fixture, then cover the side lid and tighten it. (Figure 4)

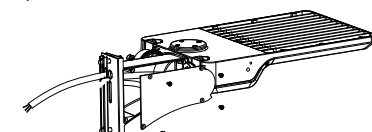

(Figure 3)

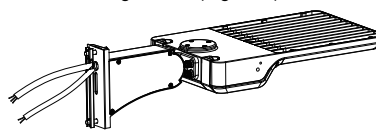

(Figure 4)

3. YOKE MOUNTING (e=YM)

- Step 1: Remove the bracket mounting screws on the fixture and pass the wires through the bracket. (Figure 5)
- Step 2: Install the bracket on the fixture. (Figure 6)

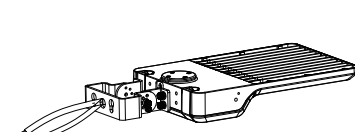

(Figure 5)

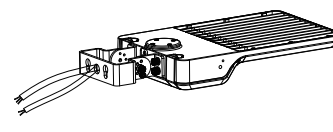

(Figure 6)

4. ADJUSTABLE FITTER MOUNTING & DIRECT MOUNTING (e=A&D)

- Step 1: Remove the bracket mounting screws on the fixture, open the side lid of bracket and pass the wires through the bracket. (Figure 7)
- Step 2: Install the bracket on the fixture, then cover the side lid and tighten it. (Figure 8)

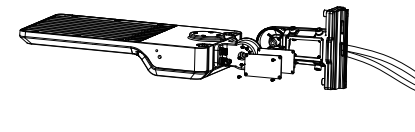

(Figure 7)

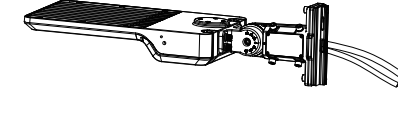

(Figure 8)

5. FLOOD MOUNTING (e=FM)

- Step 1: First install two big screws. (Figure 9)
- Step 2: Install two small screws. (Figure 9)

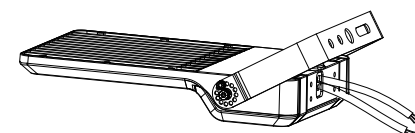

(Figure 9)

Installation of LED light:

1. ADJUSTABLE FITTER MOUNTING (e=AM)

- Step 1: Connect the wire correctly and put the wires into pole. Then fasten the locking bolts between slip fitter and the pole. (Figure 10)
 - Step 2: Loosen the fixing bolts and adjusting bolts, align the fixture to required angle. Tighten adjusting bolt and fixing bolts after the angle is confirmed. (Figure 11)
- Notice: Adjustable angle is 0~±90° (Figure 10)

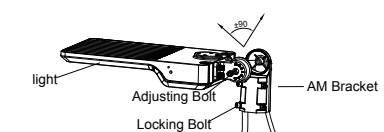

(Figure 9)

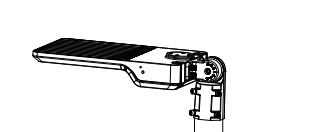

(Figure 10)

2. DIRECT MOUNTING (e=DM)

- Step 1: Fix the DM bracket to the square pole with bolt, open the side lid of DM bracket, pull the wire into junction box, and connect the wires correctly (Figure 11)
 - Step 2: Put the connected wires into the junction box, then cover the junction box (Figure 12)
- Notice: Adjustable angle range is 0-35° (Figure 11)

Same as round pole installation, please remember to remove the silicon plate when install the fixture in round pole (Figure 13)

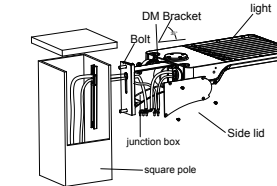

(Figure 11)

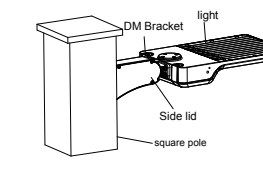

(Figure 12)

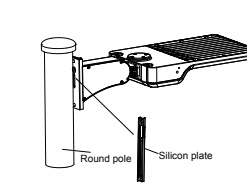

(Figure 13)

3. YOKE MOUNTING (e=YM)

- Step 1: Drill holes on the wall as shown in Figure 14.
 - Step 2: Knock the expansion bolts into the wall. (Figure 15)
 - Step 3: Connect the fixture to the bracket and tighten the screws; connect the wires properly and put them into junction box. (Figure 16)
- Notice: Adjustable angle is 0-90° (Figure 16)

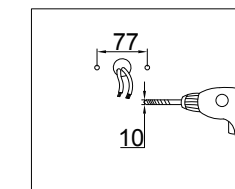

(Figure 14)

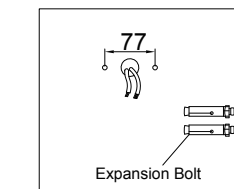

(Figure 15)

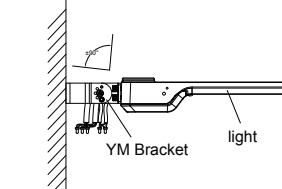

(Figure 16)

4. ADJUSTABLE FITTER MOUNTING & DIRECT MOUNTING (e=A&D)

4.1 ADJUSTABLE FITTER MOUNTING

- Step 1: Remove the spare parts from A&D bracket (Figure 14)
 - Step 2: Loosen the four bolts on A&D bracket, connect the wires correctly, and pull the wires into the pole (Figure 15)
 - Step 3: Place the bracket into the pole and lock the four bolts (Figure 15)
- Notice: Adjustable angle range is 0-90° (Figure 15)

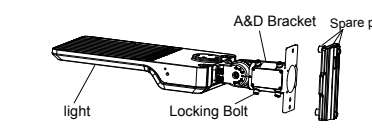

(Figure 14)

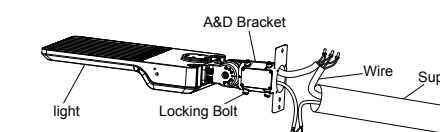

(Figure 15)

4.2 DIRECT MOUNTING

Step 1: Remove the four bolts from A&D bracket, remove the four rubber from installation bar, put the four rubber plugs on the place where the four bolts were previously placed on the bracket for waterproof purpose (Figure 16)

Step 2: Fix the A&D bracket to the square pole with bolt, open the cover of A&D bracket junction box, pull the wires into bracket junction box, connect the wires properly and cover the junction box (Figure 17)

Notice: Adjustable angle range is 0-90° (Figure 17)

Same as round pole installation, please remember to use the adapting plate for round pole installation (Figure 18)

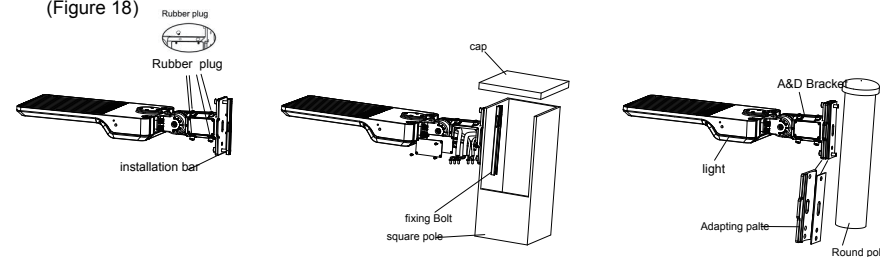

(Figure 16)

(Figure 17)

(Figure 18)

5. FLOOD MOUNTING (e=FM)

Install the mount to the fixture, tighten the mount and install the screws.

Connect the fixture to the bracket and tighten the screws; connect the wires properly and put them into junction box(Figure 19)

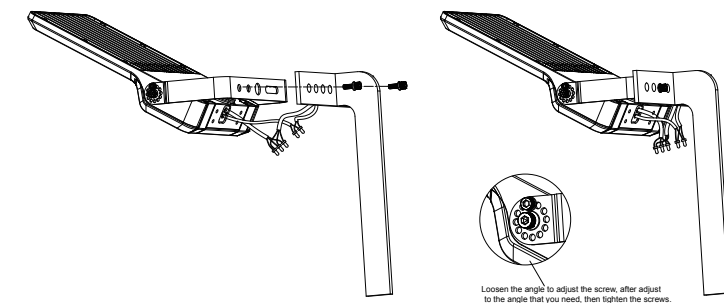

(Figure 19)

Instructions for Photocell

When the photocell function is required, photocell should be installed on the back of light;

When it's not required, shorting cap should be installed on the back of light Standard wire: (Figure 20)

L/live wire: Black\Brown;

N/null wire: White\Blue;

Ground wire: Green\Yellow-green.

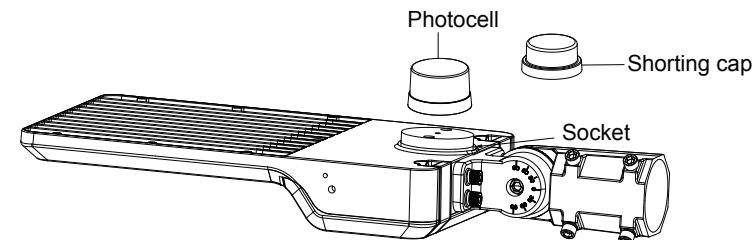

(Figure 20)

Instructions for Motion Sensor figure 21

1. Unscrew the 1/2 plug;

2. For products with motion sensor function, the induction module should be installed on the socket ;

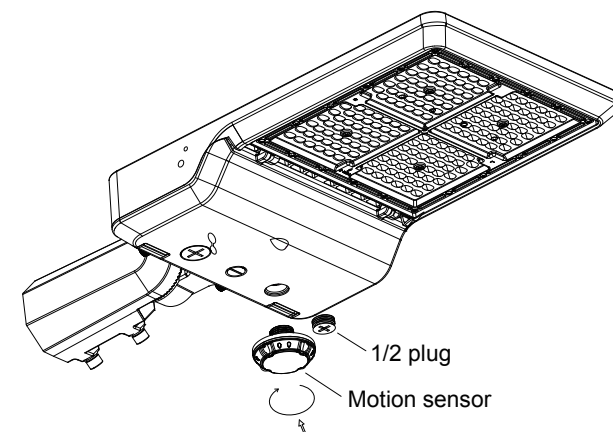

(Figure 21)

Special Functions Optional:

1. Color temperature adjustment (figure 22)

1. Unscrew the 3/4 plug ;

2. Adjust the switch to get the desired color temperature according to the label on the fixture;

3. Install and tighten the 3/4 plug;

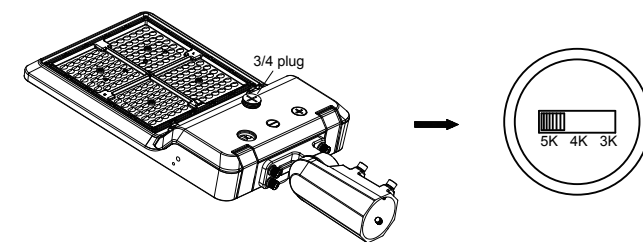

(figure 22)

2. Wattage adjustment (figure 23)

1. Open the driver plate

2. switch the controller to adjust the wattage

3. Lock the driver plate through the buckle

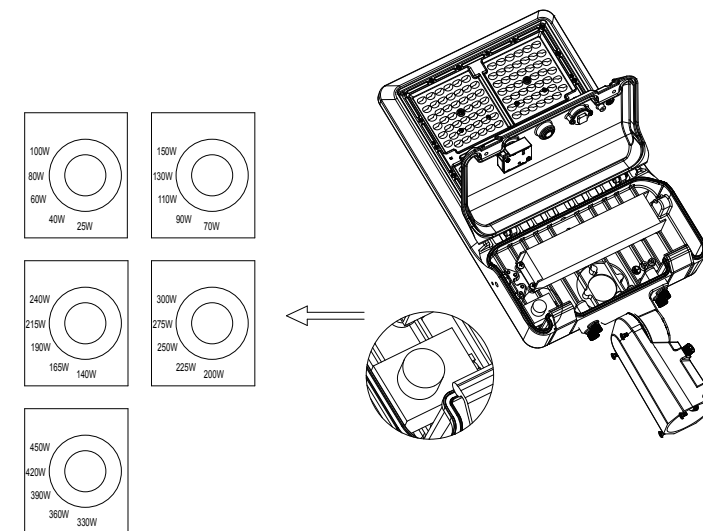

(figure 23)