

THE ROCK BOTTOM (K-991)

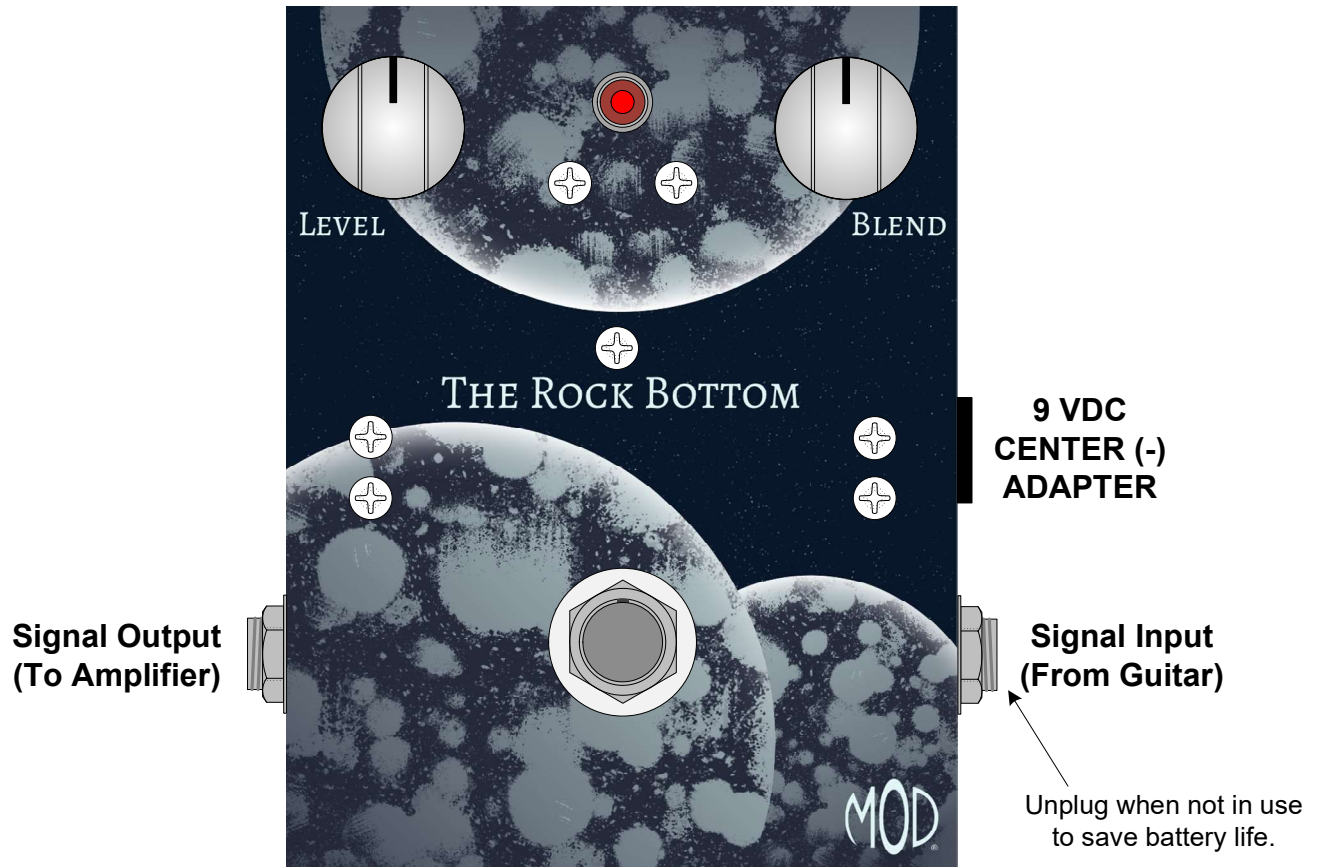

Use these instructions to learn:

- How to build an effects pedal for bass fuzz.

The Rock Bottom is a bass fuzz that gives you all of the sizzle you'd expect from a vintage fuzz without sacrificing those low frequencies. Use the blend pot to set your fuzz levels and dial in the volume to get that sound you need. This versatile pedal can be used for the sludgiest bass tones to the cleanest boost and everything in between.

Warning: This circuit was designed for use with a 9 VDC power supply only.



TABLE OF CONTENTS

TOOL LIST	2
PARTS LIST DRAWINGS.....	3, 4
FINAL ASSEMBLY REFERENCE DRAWING.....	5
SOLDERING TIPS	6
STEP BY STEP ASSEMBLY INSTRUCTIONS	7 - 10
Section 1 – Mount Large Components	7
Section 2 – Wire Large Components	8
Section 3 – Mount Components to Terminal Strips	9
Section 4 – Finishing Up	10

ASSEMBLY DRAWINGS (4 Drawings)

These are the last 2 pages. They should be separated and used as a reference to help assemble the kit correctly.

TOOL LIST

- Wire Strippers
- Needle Nose Pliers
- Cutting Pliers
- Desoldering Pump
- Solder (60/40 rosin core)
- Soldering Station
- Phillips Head Screwdrivers
- Slotted tip screwdrivers (3 mm tip)
- Channellock Pliers (or similar type)
- Ruler
- Hobby Vise (or other means to secure box while working)

PARTS LIST 1

Stranded Wire (22 AWG) – [Red]

K-PUL1569 (6 FT)

Enclosure

P-H1590BBCE-BK (1)

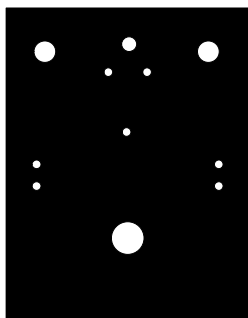

3PDT Foot Switch

P-H501-A (1)

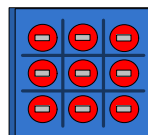

Potentiometers: 100KA

R-VAM100KA-SS (2)

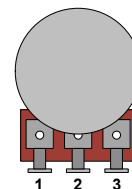

Knobs

P-K380SLV (2)

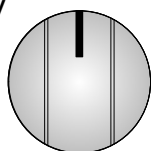

Terminal Strip with 5 Terminals

P-0501H (1)

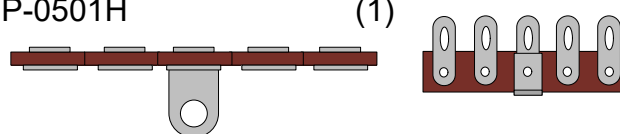

Battery Clip

S-H155 (1)

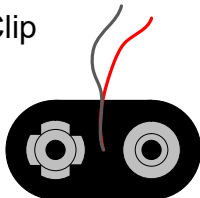

Terminal Strip with 8 Terminals

P-0802H (2)

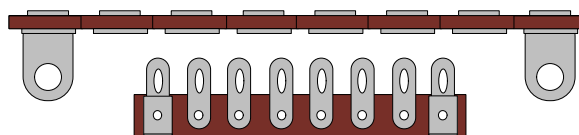

¼" Mono Jack (Output Jack)

W-SC-11 (1)

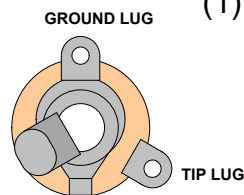

Terminal Strip with 3 Terminals

P-0301H (1)

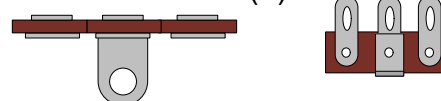

¼" Stereo Jack (Input Jack)

W-SC-12B (1)

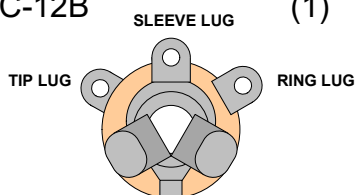

Terminal Strip with 2 Terminals

P-0201H (1)

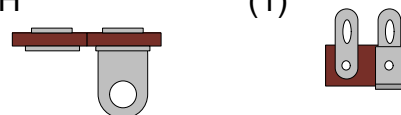

DC Power Jack

S-H750 (1)



#4 Screw (3/8" long)

S-HS440-38 (7)



#4 Nut

S-HHN440 (7)



#4 Lock Washer

S-HLW4 (7)



PARTS LIST 2

N-Channel JFET (PF5102)
P-QPF5102 (1)



NPN BJT (2N5088)
P-Q2N5088 (1)

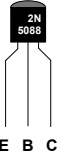

NPN Darlington (MPSA13)
P-QMPSA13 (1)

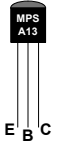

1N4148 HIGH SPEED SOLID STATE DIODE
P-Q971 (2)



Light Emitting Diode
P-L400 (1)

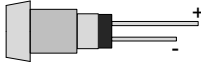

4.7μF Polarized Capacitor 35V
K-PC4D7-35 (1)



0.22μF Capacitor 100V
C-PEID22-100 (4)



500pF Capacitor 500V
C-SM500 (1)

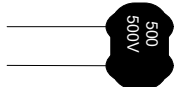

390Ω Resistor ½ W
R-A390 (1)

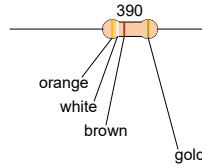

1kΩ Resistor ½ W
R-A1K (1)

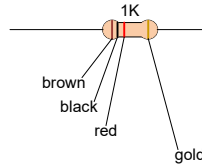

2.2kΩ Resistor ½ W
R-A2D2K (1)

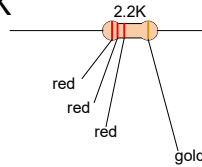

6.8kΩ Resistor ½ W
R-A6D8K (1)

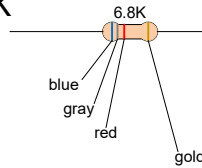

8.2kΩ Resistor ½ W
R-A8D2K (1)

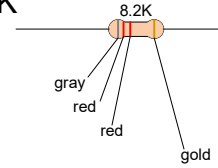

10kΩ Resistor ½ W
R-A10K (1)

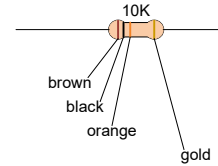

68kΩ Resistor ½ W
R-A68K (1)

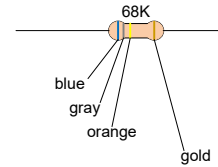

2MΩ Resistor ½ W
R-A2M (4)

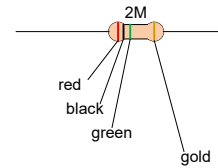

Rock Bottom Sticker (1)



FINAL ASSEMBLY REFERENCE DRAWING

This is a large version of the final assembly drawing. Refer to this drawing as you make your way through each step of the instructions. Before you make a new connection at a particular terminal or solder lug, notice how many other connections will be made at that terminal. That way you can decide whether it's best for you to solder the connection and leave space open for future connections or hold off on soldering until after every connection at that location has been made.

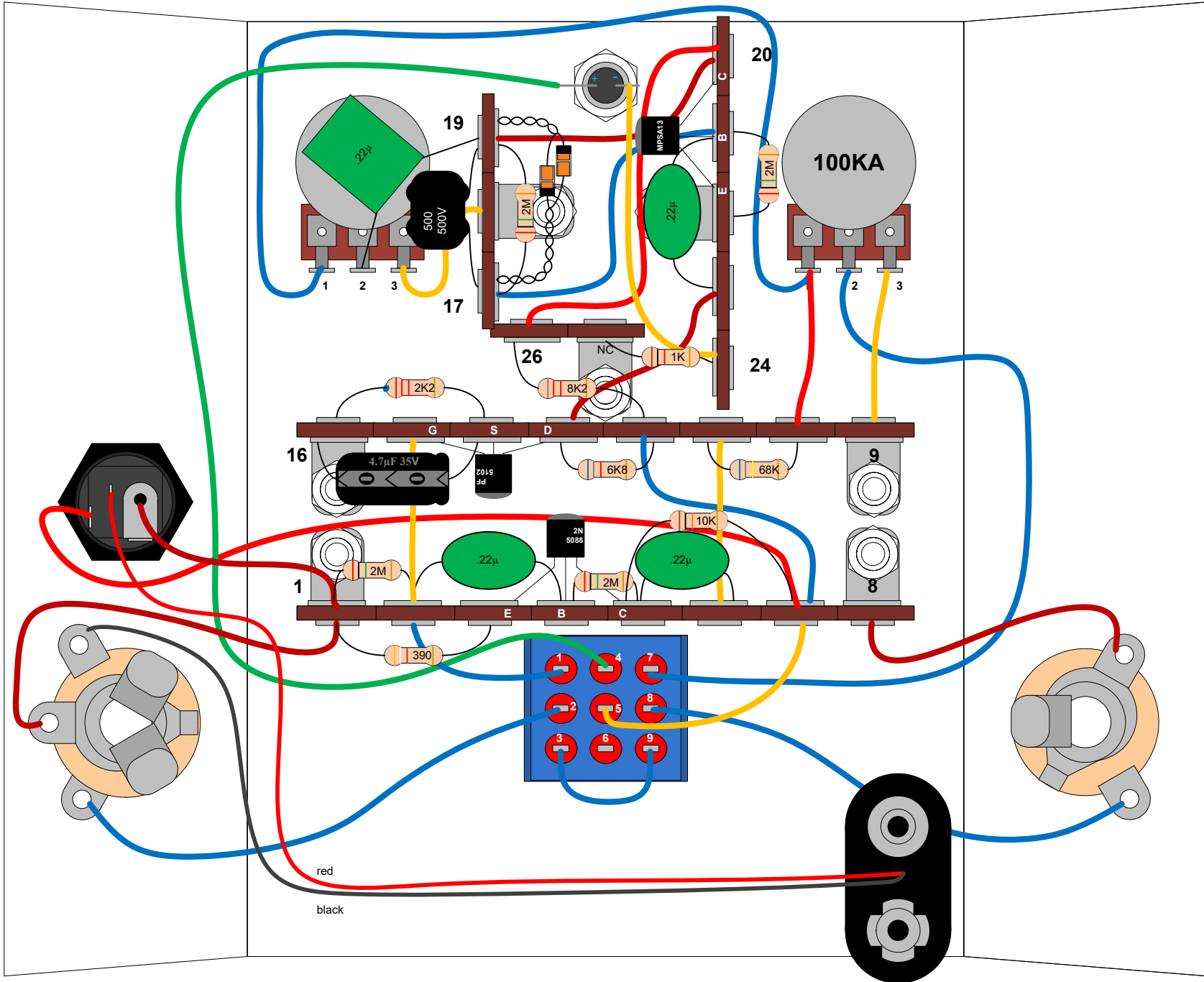

SOLDERING TIPS

It is important to make a good solder joint at each connection point. A cold solder joint is a connection that may look connected but is actually disconnected or intermittently connected. (A cold solder joint can keep your project from working.)

Follow these tips to make a good solder joint. *Take your time with each connection and make sure that all components are connected and will remain connected if your project is bumped or shaken.*

1. Bend the component lead or wire ending and wrap it around the connection point.
 - Make sure it is not too close to a neighboring component which could cause an unintended connection.
2. Wrap the component lead so that it can hold itself to the connection point.
3. Touch the soldering iron to both the component lead and the connection point allowing both to warm up just before applying the solder to them.
4. Be sure to adequately cover both component lead and connection point with melted solder.
 - Remove the soldering iron from your work and allow the solder joint to cool. (The solder joint should be shiny and smooth after solidifying.)
 - Cut off any excess wire or component leads with cutting pliers.
 - Clean the soldering iron's tip by wiping it across the wet sponge again after making the solder joint.

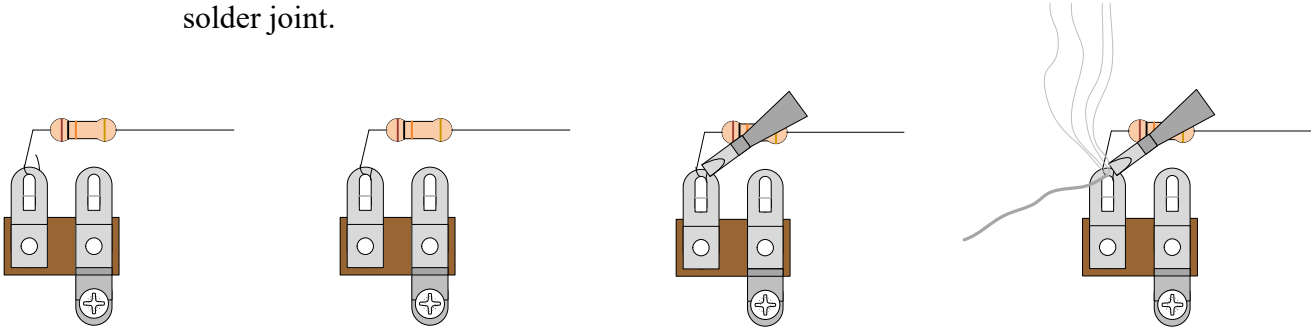

1. Bend the component lead and wrap it around the connection point.

2. Wrap the component lead so that it can hold itself to the connection point.

3. Heat up both component lead and connection point with the soldering iron.

4. Apply solder to both component lead and connection point.

De-Soldering Tip

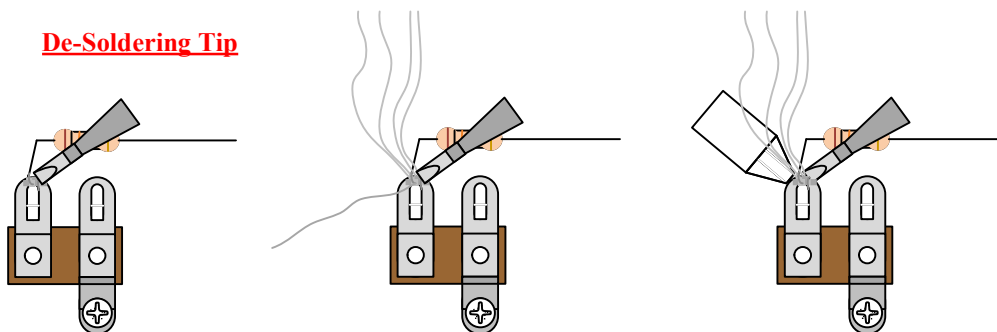

1. Heat up old solder joint with the soldering iron.

2. Apply fresh solder to mix in with old solder joint

3. Use a de-soldering tool to remove the old solder joint while it is heated.

SECTION 1 – Mount Large Components

Please refer to **DRAWING 1** and **DRAWING 2**.

Apply the sticker to the top of the box then use a blade to cut out the holes.

Orient the enclosure with the 1/4" hole on top.

Mount the LED and bezel holder in the 1/4" hole. Align the LED leads so its anode (positive lead) is closer to the left side of the enclosure as shown in Drawing 2.

The Anode (+) side of the LED is indicated by a slightly longer lead and/or a positive sign.

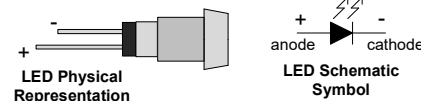

Using the seven screws, nuts and lock washers provided, fasten the five terminal strips to match **DRAWING 2**.

Fasten the 5 lug terminal strip and the 3 lug terminal strip first. Next fasten the 2 lug terminal strip. Then fasten the two 8 lug terminal strips.

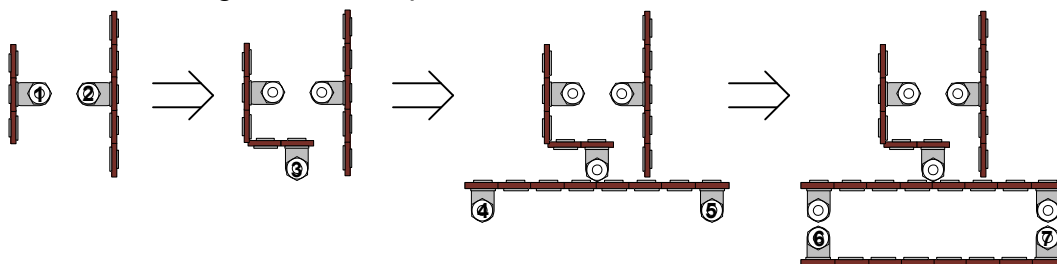

Mount one 100KA pot in the 9/32" hole on the left and the other 100KA pot in the remaining 9/32" hole on the right.

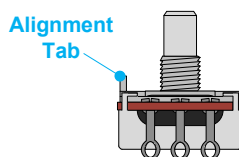

- Bend back and remove the alignment tab on the top of each potentiometer using a pair of pliers before mounting the pots so that they can mount flush against the enclosure surface.

Mount the DC power jack in the 15/32" hole on the left side of the enclosure. Orient its solder lugs so that the center-pin lug is facing the bottom side of the enclosure.

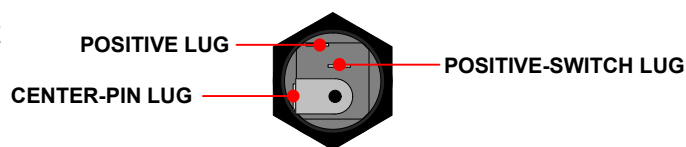

Mount the input jack in the 3/8" hole on the left side of the enclosure with the hardware provided. The washer goes under the nut on the outside of the enclosure. Make sure the center solder lug of the input jack is facing up. Correct positioning of the jack makes soldering the connections easier.

Mount the output jack in the 3/8" hole on the right side of the enclosure. Make sure the two solder lugs are in their most upright position before tightening the nut.

Mount the footswitch in the 15/32" hole in the center of the enclosure. The nylon washer goes under the mounting nut on the outside of the enclosure. Then the lock washer mounts on the inside between the enclosure surface and the other nut. Make sure that the footswitch is oriented to match **DRAWING 2**.

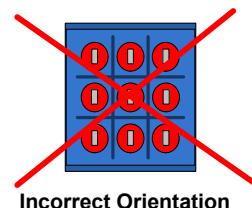

SECTION 2 – Wire Large Components

Please refer to **DRAWING 3**.

Stripping wire, tinning wire and soldering. Throughout these instructions you will be told to strip and tin a length of wire numerous times. Unless noted otherwise, cut the wire to the length stated in the instructions. Then strip $\frac{1}{4}$ " of insulation off each end. Twist each end of the stranded wire, and apply a small amount of solder to each end (i.e. tin the wire ends).

This will prevent the stranded wire from fraying and will make the final soldering much easier.

Please note that each terminal has been numbered as illustrated here and will be referred to as a "T#_" when connecting different components and wires throughout the assembly instructions.

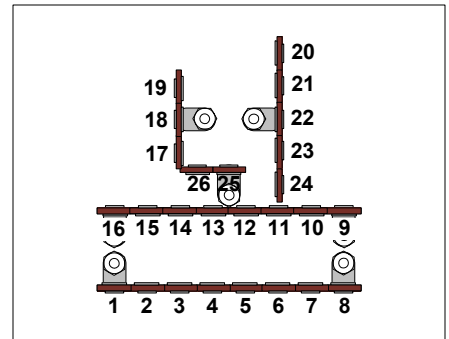

- Strip and tin a 2 $\frac{1}{2}$ " piece of wire and connect the input tip lug to lug 2 of the footswitch.
- Strip and tin a 2 $\frac{1}{2}$ " piece of wire and connect the output jack tip lug to lug 8 of the footswitch.
- Strip and tin a 1 $\frac{1}{4}$ " piece of wire and connect lug 3 of the footswitch to lug 9 of the footswitch.
- Strip and tin a 4" piece of wire and connect lug 7 of the footswitch to lug 2 of the right pot.
- Strip and tin a 2" piece of wire and connect the input jack sleeve lug to T1.
- Strip 1" of insulation off the end of the wire. Twist and tin. This will be used as a jumper wire. Snip off and connect to the ground lug of the output jack and T8 wrapping the excess wire around both lugs.
- Strip and tin a 3 $\frac{1}{2}$ " piece of wire and connect the positive lug of the power jack to T7.

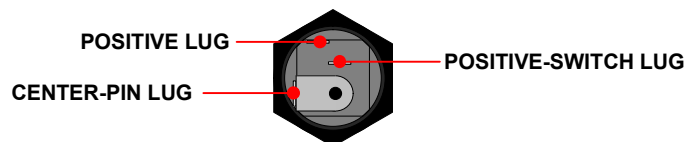
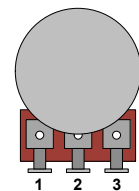
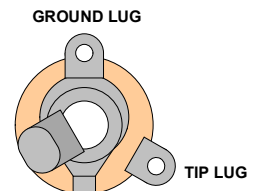
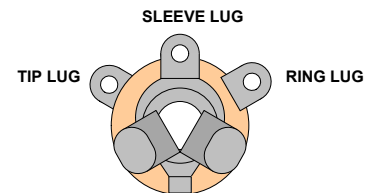
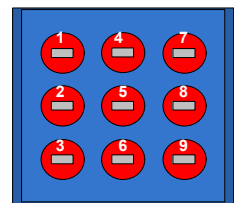

- Strip and tin a 1 $\frac{1}{2}$ " piece of wire and connect lug 1 of the footswitch to T2.
- Strip and tin a 1 $\frac{3}{4}$ " piece of wire and connect T2 to T15.
- Strip and tin a 1 $\frac{3}{4}$ " piece of wire and connect T6 to T11.
- Strip and tin a 2 $\frac{1}{2}$ " piece of wire and connect T7 to T12.
- Strip and tin a 2 $\frac{1}{2}$ " piece of wire and connect T13 to T23.

- Strip and tin a 5 ½" piece of wire and connect lug 1 of the left pot to lug 1 of the right pot.
- Strip and tin a 1" piece of wire and connect lug 3 of the left pot to T18.
- Strip and tin a 1 ½" piece of wire and connect lug 1 of the right pot to T10.
- Strip and tin a 1 ½" piece of wire and connect lug 3 of the right pot to T9.
- Strip and tin a 2" piece of wire and connect T19 to T20.
- Strip and tin a 2 ½" piece of wire and connect T20 to T26.
- Strip and tin a 3" piece of wire and connect T17 to T21.
- Strip and tin an 8" piece of wire and connect lug 4 of the footswitch to the positive (+) lead of the LED indicator light.
- Strip and tin an 2 ¾" piece of wire and connect T24 to the negative (-) lead of the LED indicator light.
- Strip and tin a 3" piece of wire and connect lug 5 of the footswitch to T7.
- Strip ½" of insulation off the end of the wire. Twist and tin. Snip off tinned lead and connect the center-pin lug of the DC power jack and T1, wrapping excess wire around both.

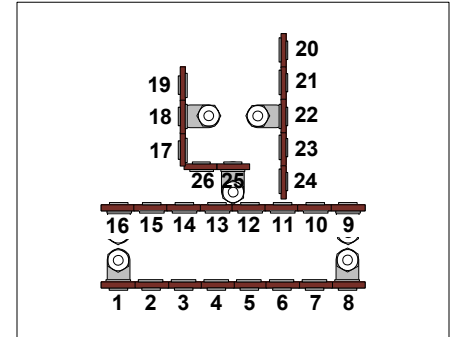
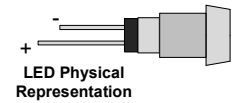
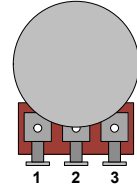

Double check all of your connections at this point because it will be very difficult to make corrections after the components are soldered into place.

SECTION 3 – Mount Components to Terminal Strips

Please refer to **DRAWING 4**.

Connect and solder all the following components to their respective terminals as listed. *(Make sure that none of the component leads are so close together that it could cause an unintended short).*

- Connect the 390Ω resistor to T1 and T3.
- Connect a 2M resistor to T1 and T2. **Solder connections on T1 now.**
- Connect a 0.22μF cap to T2 and T4. **Solder connections on T2 now.**
- Connect a 2M resistor to the lower holes of T4 and T5.
- Connect a 0.22μF cap to T5 and T6.
- Connect the 10K resistor to T5 and T7.
- Connect the 2N5088 transistor to T3, T4, and T5. Make sure the flat side of the transistor is facing up. **Solder connection on T3, T4, T5, T6 and T7 now.**

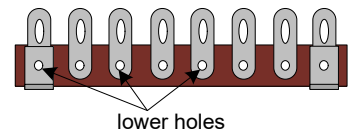

- T3:** Emitter
- T4:** Base
- T5:** Collector

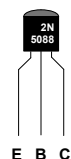

- Connect the 4.7 μ F capacitor to T14 and T16. Make sure the negative side (-) of the capacitor is connected to T16.

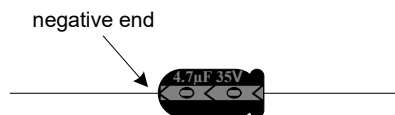

- Connect the 2.2K resistor to T14 and T16. **Solder connections on T16 now.**
- Connect the 6.8K resistor to T12 and T13.
- Connect the 68K resistor to T10 and T11. **Solder connections at T10 and T11 now.**

- Connect the PF5102 transistor to T13, T14, and T15. Make sure the flat side of the PF5102 is facing up. **Solder the connections on T13, T14, and T15.**

T13: Drain
T14: Source
T15: Gate



- Connect the 8.2K resistor to T12 and T26. **Solder the connections on T12 and T26 now.**
- Connect a 0.22 μ F cap to T19 and lug 2 of the left pot. Lay the cap down on the back of the left pot, insuring the leads don't touch the metal body of the pot. **Solder the connection on lug 2 of the pot now. Solder the connection at T18 as well.**
- Connect a 2M resistor to T17 and T19.
- Connect the 500pF capacitor to T17 and T19.
- Connect the two 1N4148 diodes so the black bands are on opposing sides so one black band is closer to T17 and the other closer to T19. **Solder the connection on T17 and T19 now.**
- Connect the remaining 0.22 μ F capacitor to T21 and T23. **Solder the connections on T23 now.**
- Connect the remaining 2M resistor to T21 and T22.
- Connect the 1K resistor to T24 and T25.

- Connect the MPSA13 transistor to T20, T21 and T22. Make sure the flat side of the MPSA13 is facing up. **Solder the connections on T20, T21, T22, T24, and T25 now.**

T20: Collector
T21: Base
T22: Emitter



- Locate the battery snap connector. Connect its red wire to the power jack's "positive switch" lug and connect its black wire to the input jack's ring lug
- **Solder all remaining connections now. (Footswitch lugs 1-9, all input jack lugs, all output jack lugs, all DC power jack lugs, pot lugs, T8, T9, and both legs of the LED if you haven't done so already.**

SECTION 4 – Finishing Up

It's always a good idea to thoroughly double-check your connections before applying power.

Attach the knobs provided to the two potentiometer shafts. Install 9 volt battery, close cover using screws provided. Plug guitar into input jack on right. This turns unit on. Plug cable into output jack and plug into your amplifier.

Unplug from the input jack of the unit to turn it off and save power.

DRAWING 1

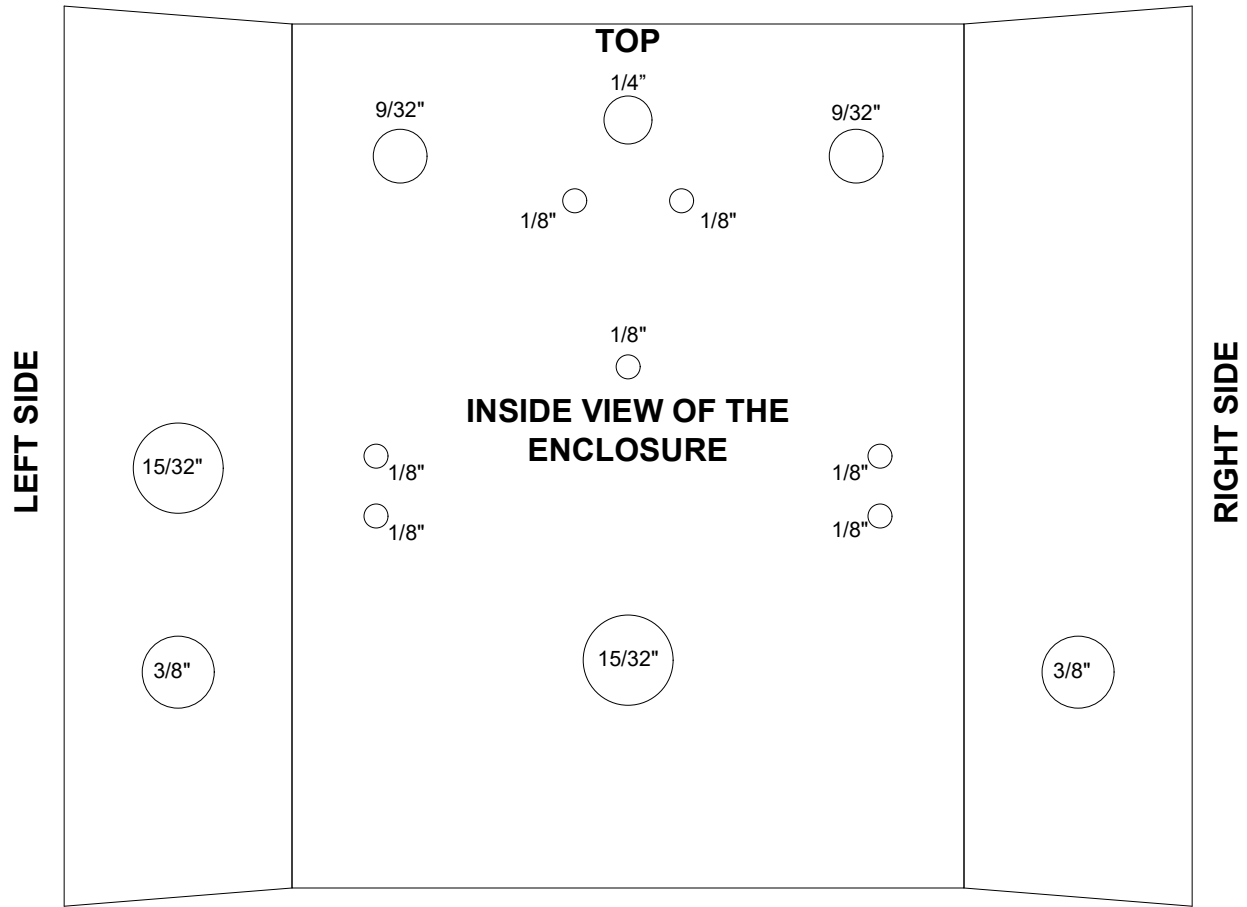

DRAWING 2

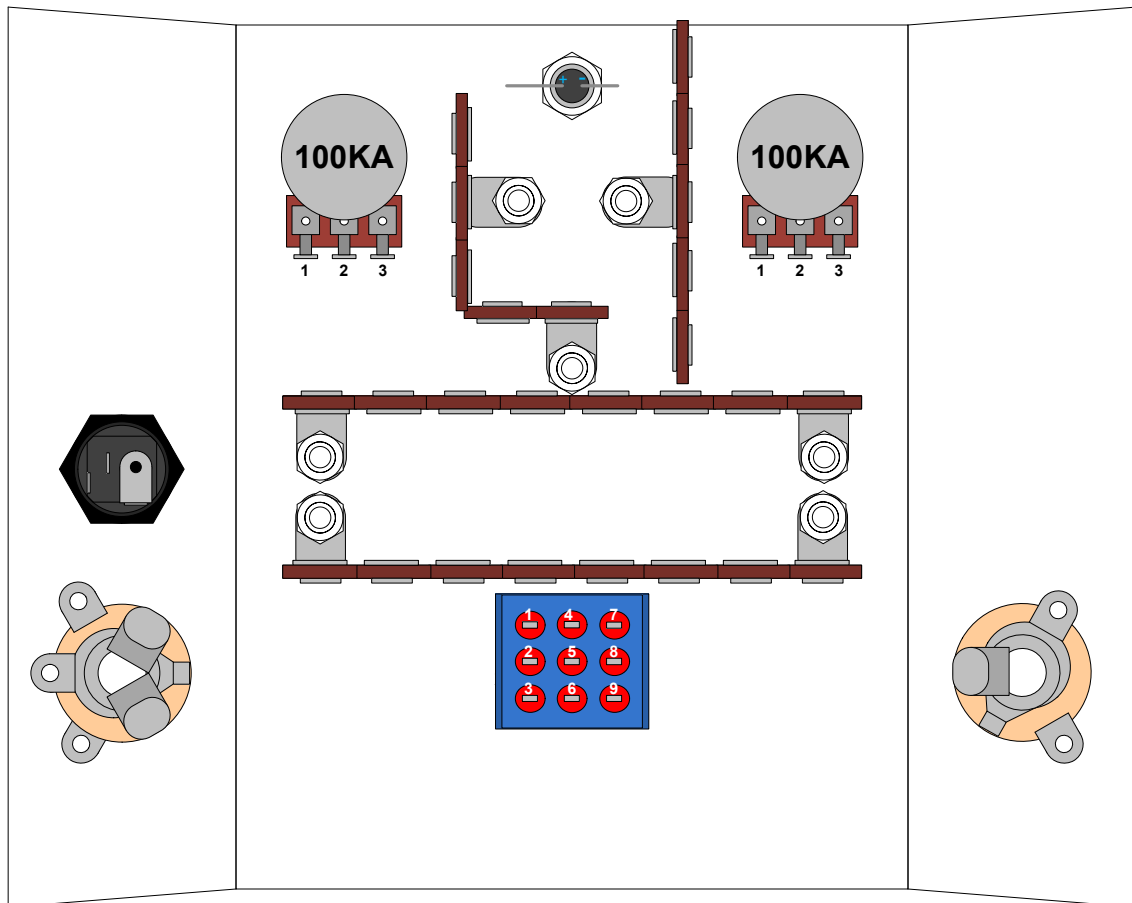

DRAWING 3

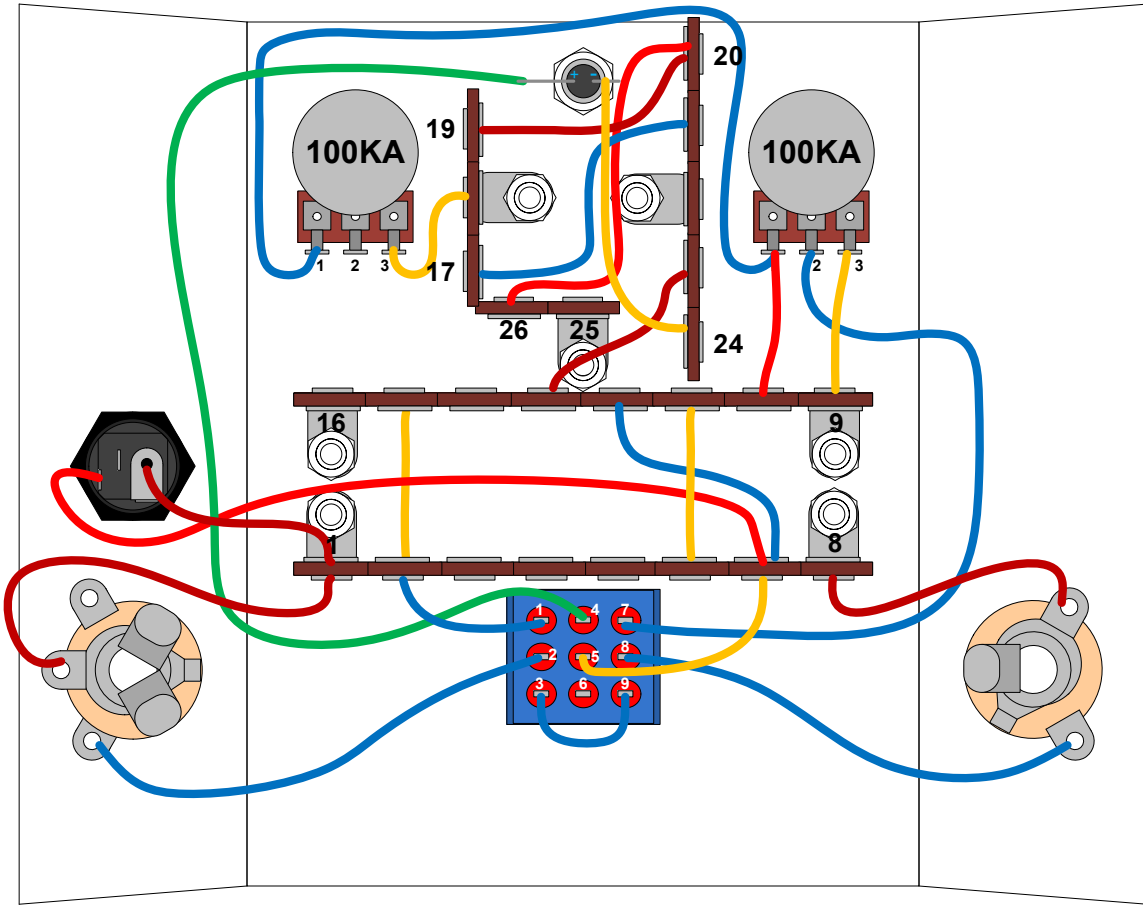

DRAWING 4

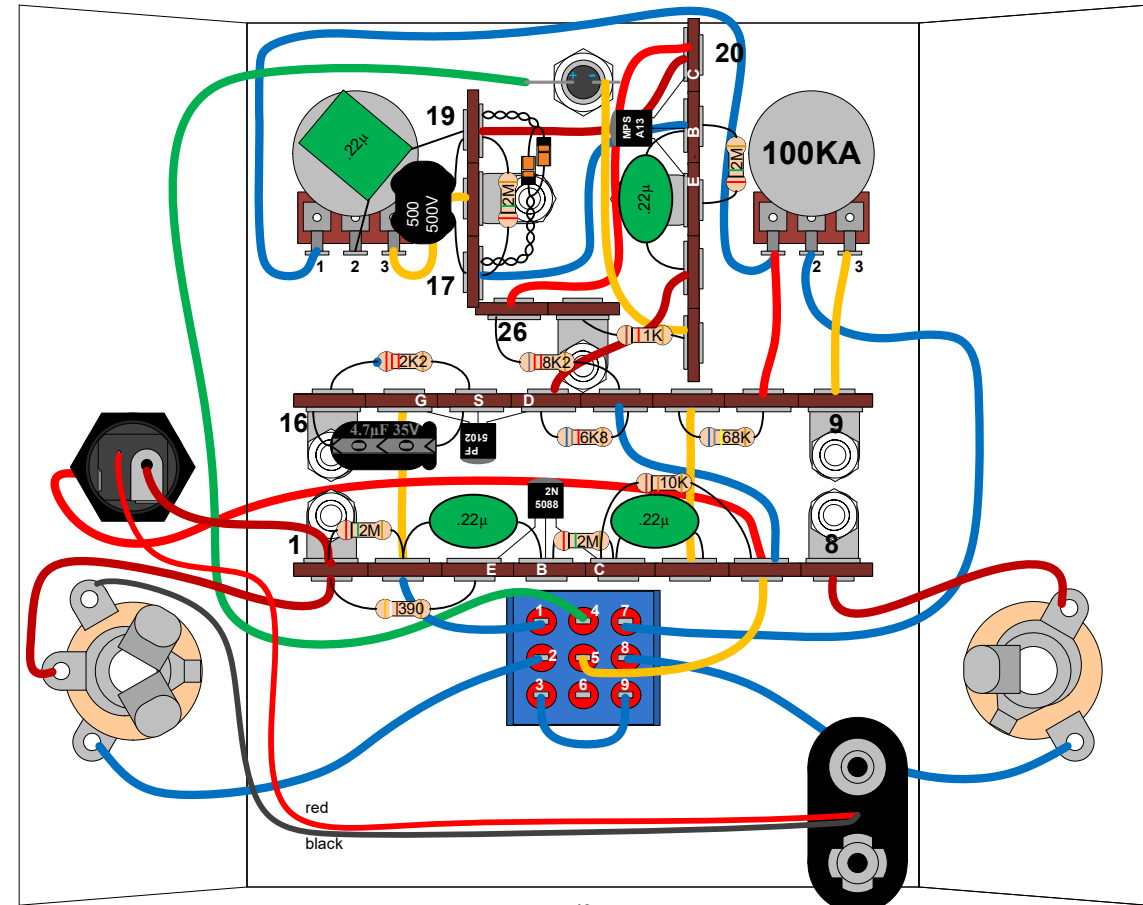

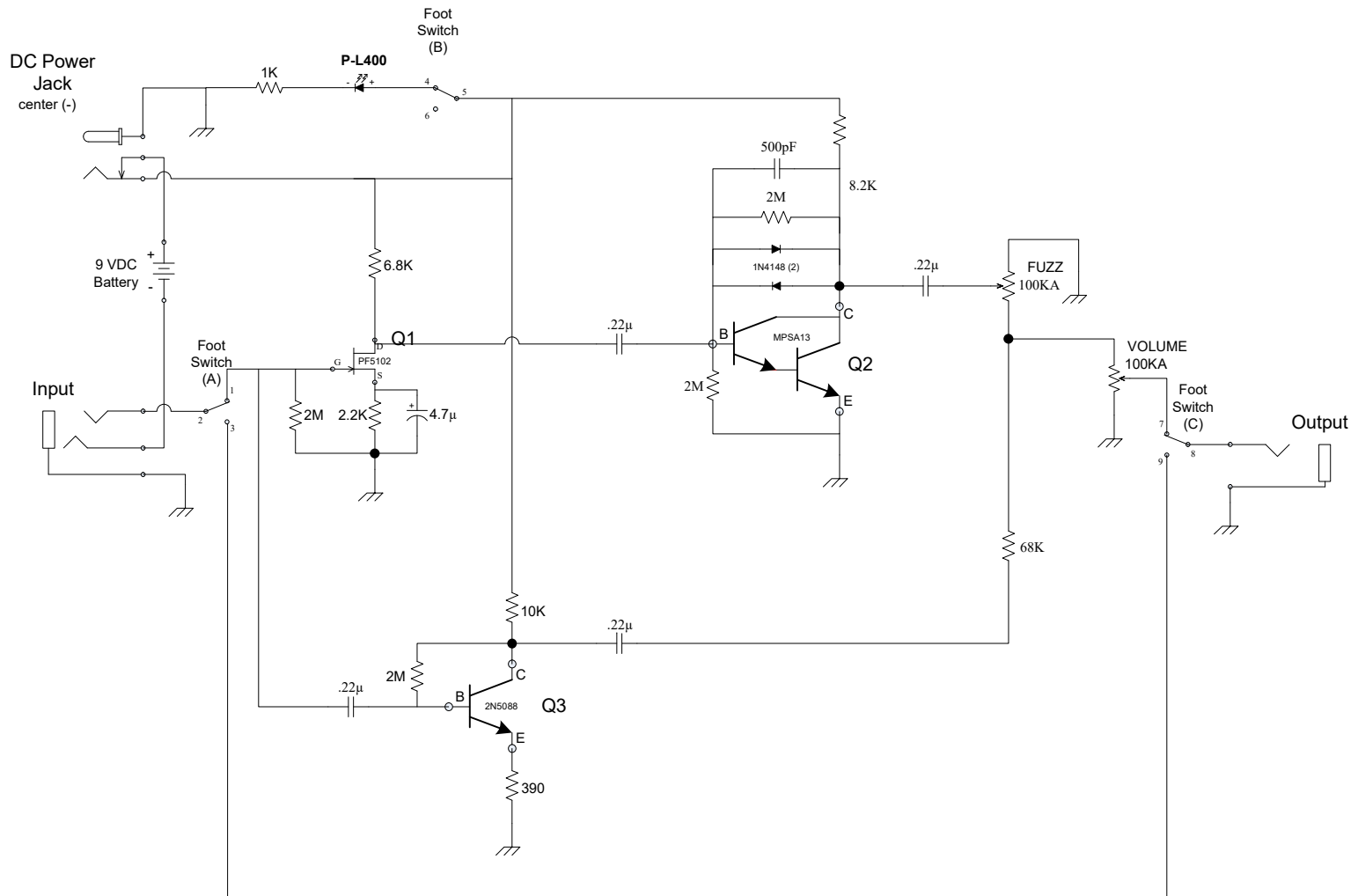

3PDT Foot Switch

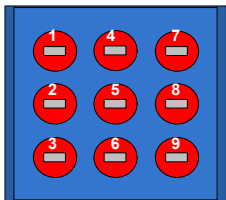

PF5102
n-channel
JFET

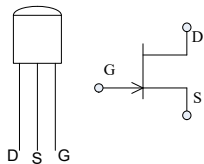

2N5088
NPN BJT

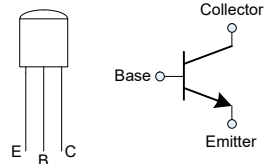

MPSA13
NPN Darlington Transistor

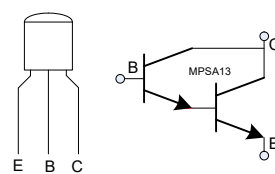

MOD[®]

www.modkitsdiy.com

Copyright © 2018 by modkitsdiy.com

**"The Rock Bottom" (K-991)
Schematic**

APPLYING THE STICKER TO MOD PEDAL ENCLOSURES

1.

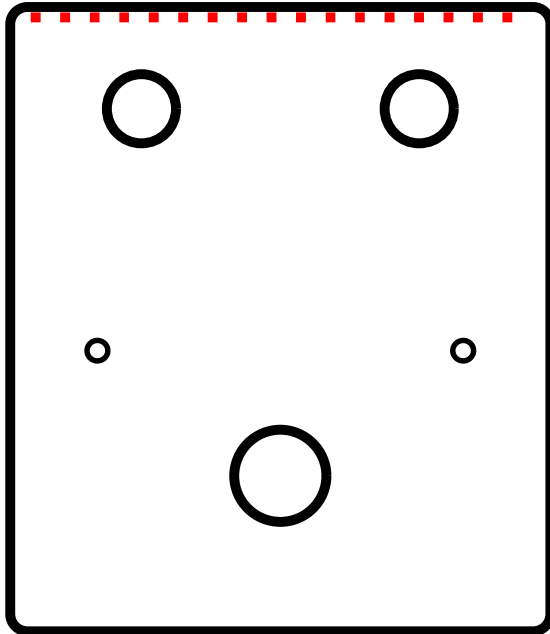

- Locate the top of the pedal as well as the top of the sticker. Page one of the instructions for your kit will have an image of the pedal that can be used for reference.

2.

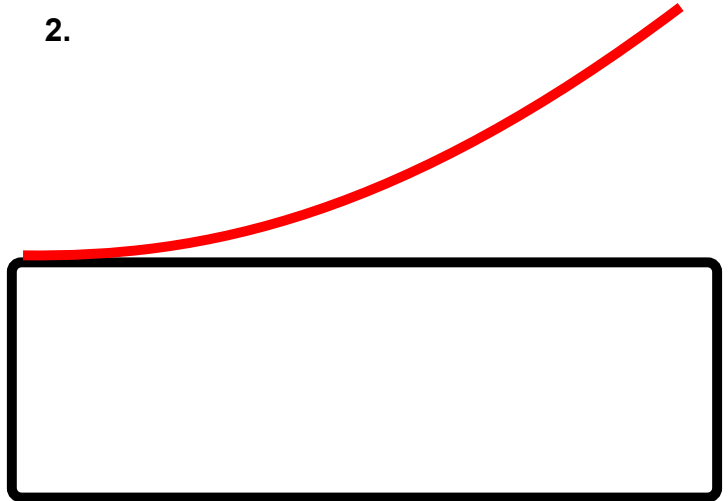

- Peel the backing from the sticker. Carefully line up the top edge of the sticker with the top of the pedal. Press down to apply the sticker only to the edge. Run a finger across the edge to push any air out from beneath the sticker. Continue this motion as you work your way down the pedal until the sticker is fully attached.

3.

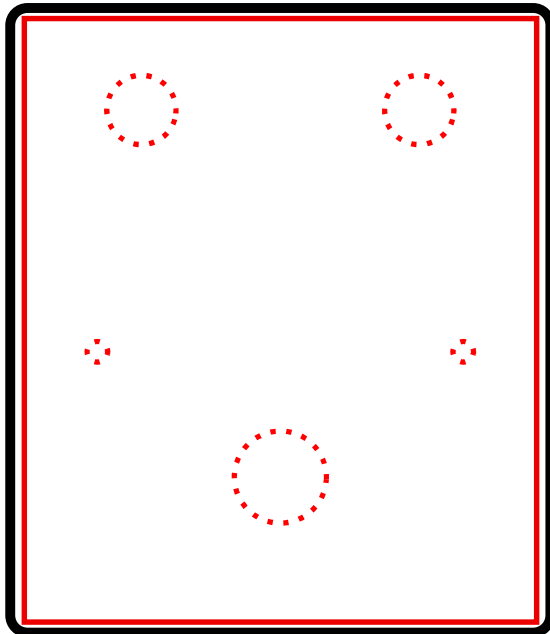

- Locate the holes beneath the sticker and depress them using a fingertip. Be sure that the area of the sticker surrounding the holes is fully adhered to the surface.

4.

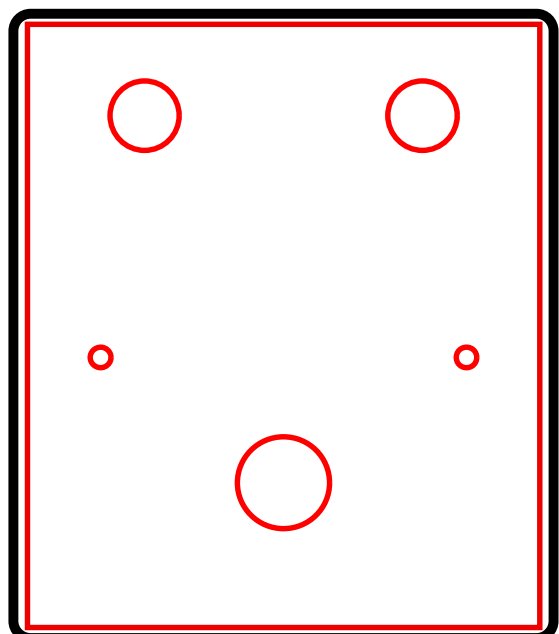

- With an Xacto knife or similar tool, carefully pierce the sticker in the center of each hole. Carefully work the knife from the center of the hole to the edge and begin cutting fully around the edge until the sticker has been fully cleared from the hole.