

# THE RATTLER RETURNS (K-901)

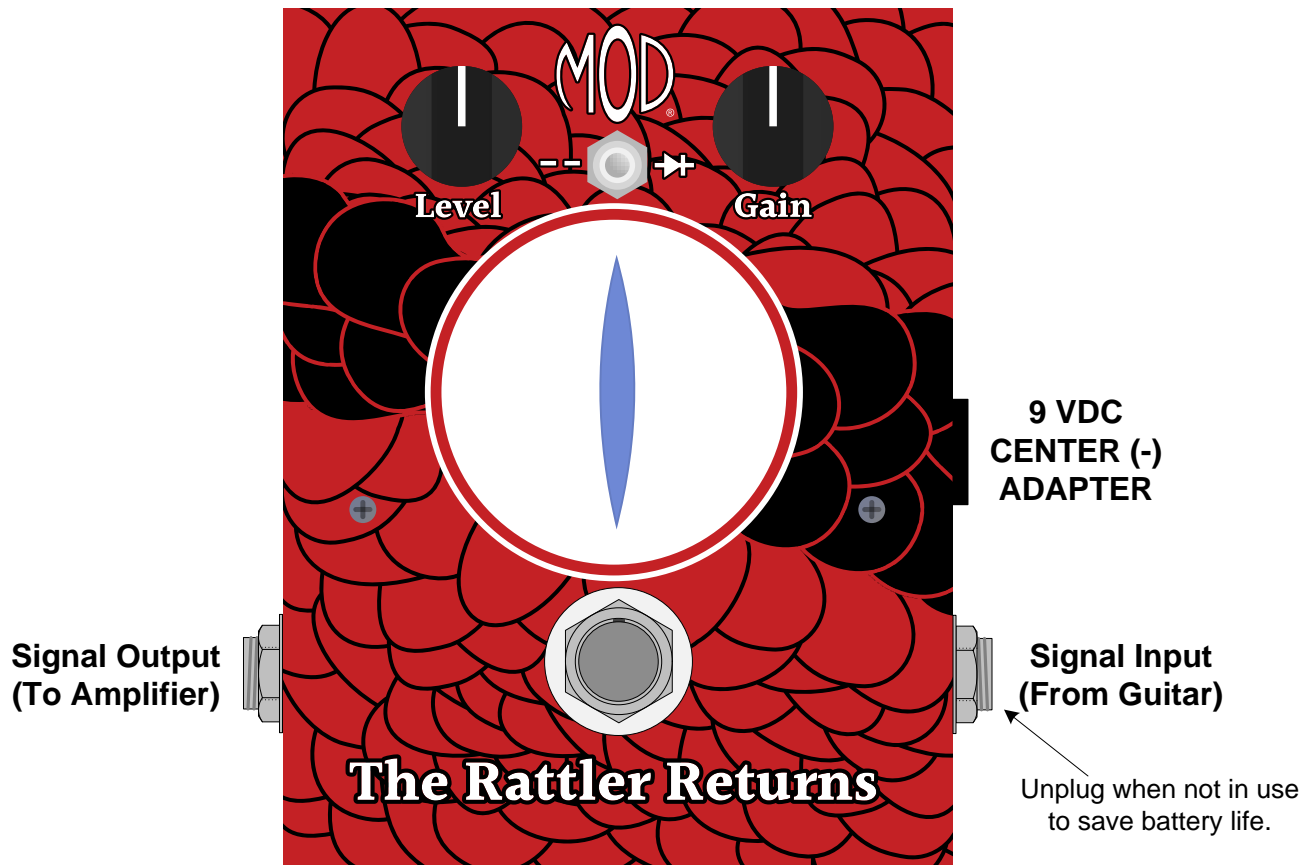

Use these instructions to learn:

- How to build an effects pedal for fuzz with diode clipping.

To celebrate the 10 year anniversary of Mod® kits, we are re-releasing a new and improved version of the original Mod pedal - The Rattler. This fan favorite is making its long-awaited comeback as The Rattler Returns. The Rattler Returns offers the same over the top fuzz as the original Rattler and features several new upgrades. The circuit has been overhauled for a wider spectrum of fuzz that is steady when used with any pickups, pedals, or amps. The Rattler Returns preserves the diode clipping, a crucial component of the classic raw fuzz/distortion in the original but also features a diode lift switch. With the lift engaged, the pedal can hit volumes that easily drive any tube or pedal with fuzzed out guitar tones. The pedal now operates on +9V, so standard DC power supplies can be used in lieu of a battery if you choose.

**Warning:** This circuit was designed for use with a 9 VDC power supply only.



## **TABLE OF CONTENTS**

TOOL LIST	p. 2
PARTS LIST DRAWINGS	p. 3, 4
FINAL ASSEMBLY REFERENCE DRAWING	p. 5
SOLDERING TIPS	p. 6
STEP BY STEP ASSEMBLY INSTRUCTIONS	p. 7 - 9
Section 1 - Mount Large Components	p. 7
Section 2 - Wires and Resistors	p. 7-8
Section 3 – Remaining Components	p. 9
Section 4 - Finishing Up	p. 9
ASSEMBLY DRAWINGS (4 Drawings)	p. 10 - 11
Use these as a reference for assembly.	
SCHEMATIC	p. 12
STICKER APPLICATION GUIDE	p. 13

---

## **TOOL LIST**

- Wire Strippers
- Needle Nose Pliers
- Cutting Pliers
- Desoldering Pump
- Solder (60/40 rosin core)
- Soldering Station
- Phillips Head Screwdrivers
- Slotted tip screwdrivers (3 mm tip)
- Channellock Pliers (or similar type)
- Ruler
- Hobby Vise (or other means to secure box while working)
- Xacto Knife or similar cutting tool

# PARTS LIST 1

DPDT Foot Switch

P-H498

(1)

Stranded Topcoat Wire (22 AWG) - Red

S-W3222TC-R-50 (3 FT)

Enclosure

P-H1590BBCE-R (1)

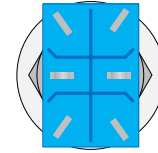
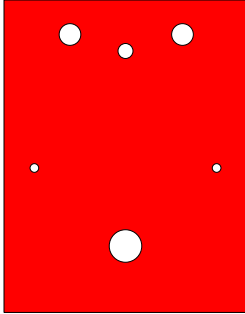

Potentiometers (24 mm diameter)

R-VA1KL

(1)

R-VA100KA

(1)

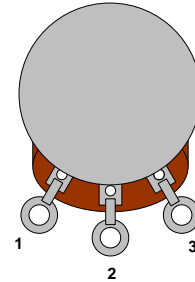

Black Knob with White Line

P-K680 (2)



Battery Clip

S-H155 (1)

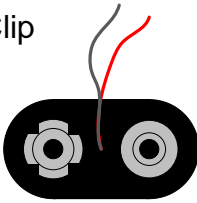

Terminal Strip with 8 Terminals

P-0802H

(1)

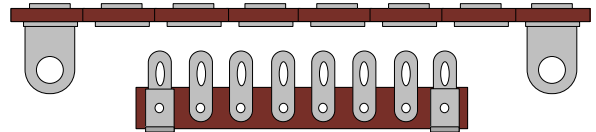

1/4" Mono Jack (Output Jack)

W-SC-11 (1)

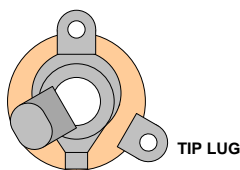

#4 Screw (3/8" long)

S-HS440-3/8



(2)

#4 Nut

S-HKEP-440



(2)

1/4" Stereo Jack (Input Jack)

W-SC-12B (1)

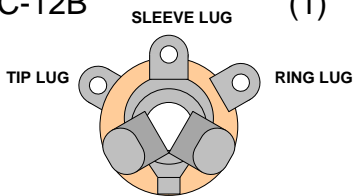

SPDT Toggle Switch

P-H540

(1)

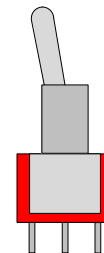

DC Power Jack

S-H750 (1)



Toggle Switch Cap - Red

P-H54-CAP-R

(1)



## PARTS LIST 2

NPN BJT (2N3904)

P-Q2N3904

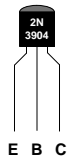

(2)

10 $\mu$ F Electrolytic Capacitor 50V

C-ET10-50

(1)



0.047 $\mu$ F Capacitor 100V

C-PEID047-100

(1)



0.1 $\mu$ F Capacitor 100V

C-PEID1-100

(1)

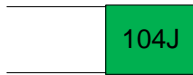

10k $\Omega$  Resistor  $\frac{1}{2}$  W

R-A10K

(1)

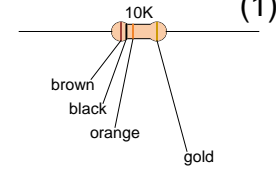

82k $\Omega$  Resistor  $\frac{1}{2}$  W

R-A82K

(1)

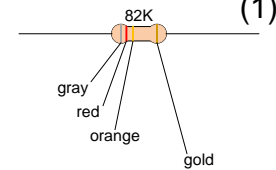

100k $\Omega$  Resistor  $\frac{1}{2}$  W

R-A100K

(1)

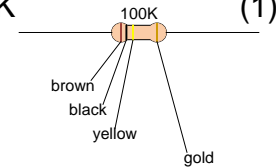

1N4148 High Speed Diode

P-Q971

(2)



“The Rattler Returns” Sticker (1)

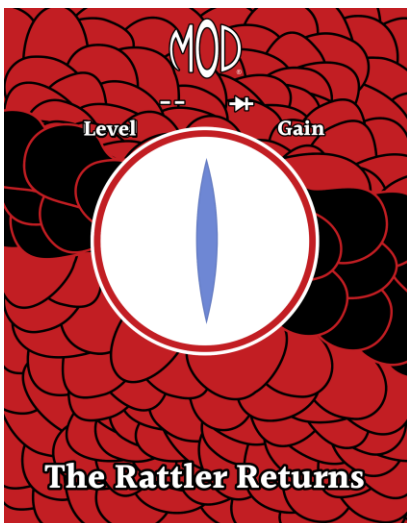

## FINAL ASSEMBLY REFERENCE DRAWING

This is a large version of the final assembly drawing. Refer to this drawing as you make your way through each step of the instructions. Before you make a new connection at a particular terminal or solder lug, notice how many other connections will be made at that terminal. That way you can decide whether it's best for you to solder the connection and leave space open for future connections or hold off on soldering until after every connection at that location has been made.

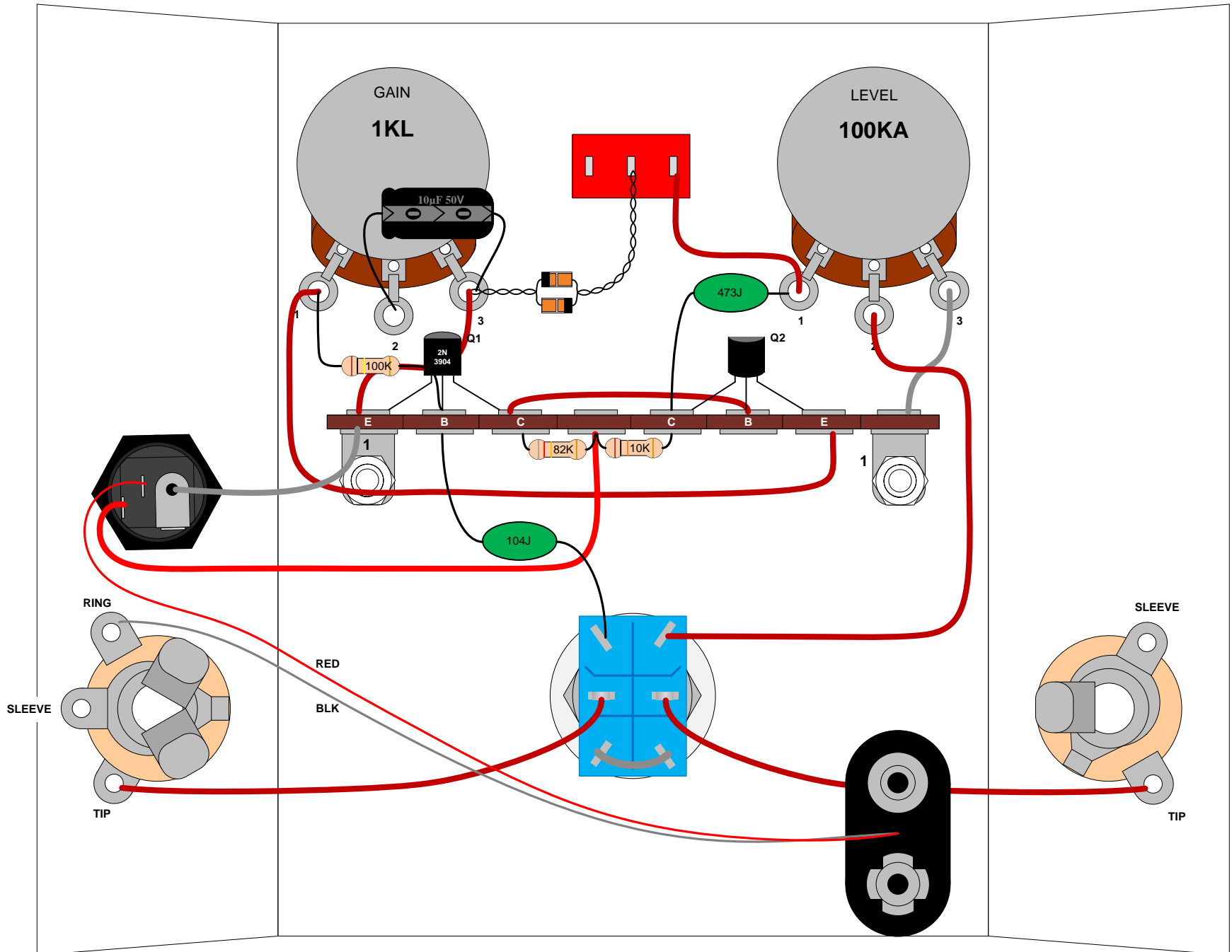

## SOLDERING TIPS

It is important to make a good solder joint at each connection point. A cold solder joint is a connection that may look connected but is actually disconnected or intermittently connected. (A cold solder joint can keep your project from working.)

Follow these tips to make a good solder joint. *Take your time with each connection and make sure that all components are connected and will remain connected if your project is bumped or shaken.*

1. Bend the component lead or wire ending and wrap it around the connection point.
  - Make sure it is not too close to a neighboring component which could cause an unintended connection.
2. Wrap the component lead so that it can hold itself to the connection point.
3. Touch the soldering iron to both the component lead and the connection point allowing both to warm up just before applying the solder to them.
4. Be sure to adequately cover both component lead and connection point with melted solder.
  - Remove the soldering iron from your work and allow the solder joint to cool. (The solder joint should be shiny and smooth after solidifying.)
  - Cut off any excess wire or component leads with cutting pliers.
  - Clean the soldering iron's tip by wiping it across the wet sponge again after making the solder joint.

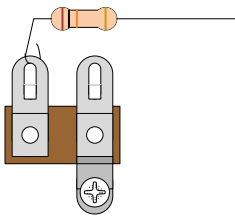

1. Bend the component lead and wrap it around the connection point.

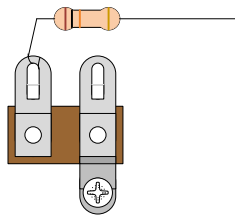

2. Wrap the component lead so that it can hold itself to the connection point.

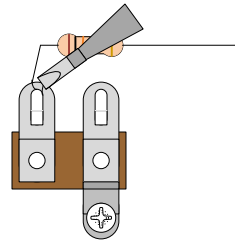

3. Heat up both component lead and connection point with the soldering iron.

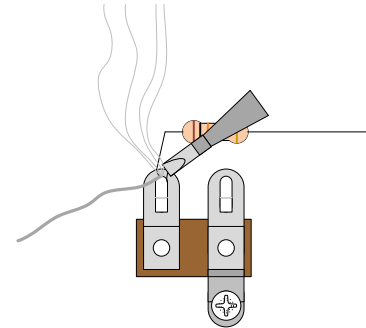

4. Apply solder to both component lead and connection point.

### De-Soldering Tip

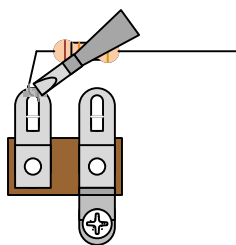

1. Heat up old solder joint with the soldering iron.

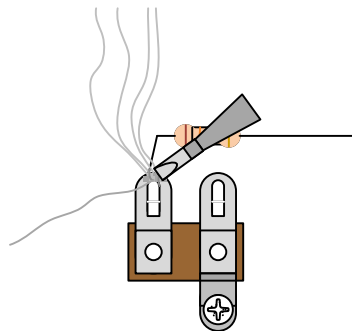

2. Apply fresh solder to mix in with old solder joint

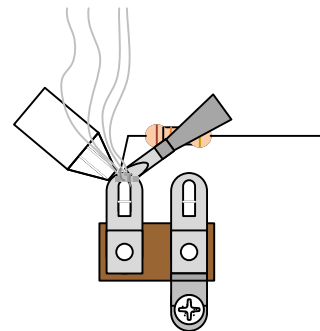

3. Use a de-soldering tool to remove the old solder joint while it is heated.

## SECTION 1 – Mount Large Components

Please refer to **DRAWING 1** and **DRAWING 2**. (pg. 10)

Apply the sticker to the top of the box and use a blade to cut out the holes.

Orient the enclosure with the two 5/16" holes and one 1/4" hole on top.

- Using the two screws, and kep nuts provided, fasten the terminal strip to the two 1/8" holes matching **DRAWING 2**.
- Mount the 1KL pot in the 5/16" hole on the left and the 100KA pot in the other 5/16" hole on the right.
  - *Bend back and remove the alignment tab on the top of each potentiometer using a pair of pliers before mounting the pots so that they can mount flush against the enclosure surface.*

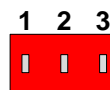
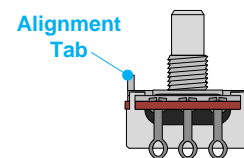
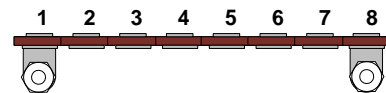

- Mount the toggle switch in the 1/4" hole between the two pots. Orient the three lugs horizontally in the pedal.
- Mount the DC power jack in the 15/32" hole on the left side of the enclosure. Orient its solder lugs similar to how they are shown in Drawing 2.

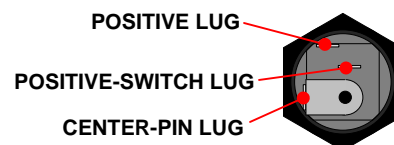

- Mount the input jack in the 3/8" hole on the left side of the enclosure with the hardware provided. The washer goes under the nut on the outside of the enclosure. Make sure the center solder lug of the input jack is facing up. Correct positioning of the jack makes soldering the connections easier.

### Input Jack

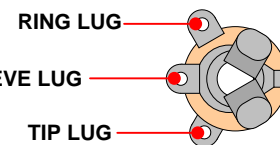

- Mount the output jack in the 3/8" hole on the right side of the enclosure. Make sure the two solder lugs are in their most upright position before tightening the nut.

### Output Jack

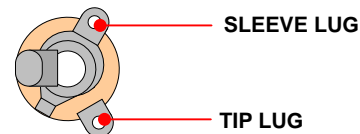

- Mount the footswitch in the 15/32" hole in the center of the enclosure. The nylon washer goes under the mounting nut on the outside of the enclosure. The lock washer mounts on the inside between the enclosure surface and the other nut. Orient the footswitch to match **DRAWING 2**.

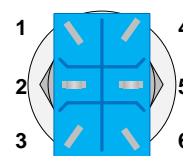

*Lug numbers shown on the footswitch above and other parts are arbitrarily assigned. These numbers are only meant to be used as references in these instructions and may not match lug numbering systems used elsewhere.*

## SECTION 2 – Wires and Resistors

Please refer to **DRAWING 3**. (pg. 11)

**Stripping wire.** Throughout these instructions you will be told to strip a length of wire numerous times. Unless noted otherwise, cut the wire to the length stated in the instructions, then strip 1/4" of insulation off each end.

**Tip:** Some terminals will have three or more wire/component connections which can make it difficult to find room for everything that needs to be connect to that terminal. In this case, we will provide a warning and suggest connecting wires to the lower terminal holes. Be sure to only solder the bottom when instructed to do so leaving the top hole untouched.

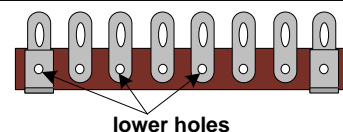

Please note that each terminal has been numbered as illustrated here and will be referred to as a "terminal #\_" when connecting different components and wires throughout the assembly instructions.

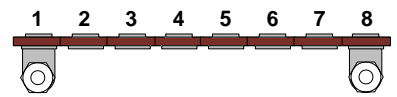

- Strip 1" of insulation off one end of the wire and then cut this bare piece of wire. With this bare wire, connect lug 3 of the 100KA pot to the lower hole of terminal #8. Solder both connections now.

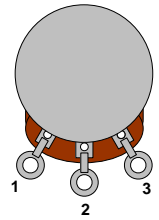
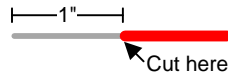

- Strip 1" of insulation off one end of the wire and then cut this bare piece of wire. With this bare wire, connect the center-pin lug of the DC jack and terminal #1. Solder the center-pin lug of the DC jack now.

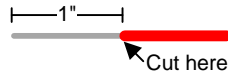

- Strip 3/4" of insulation off one end of the wire and then cut this bare piece of wire. With this bare wire, connect lugs 3 and 6 of the footswitch. Solder both connections now.

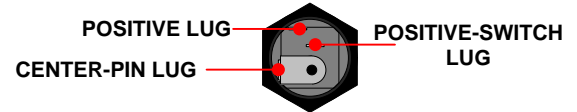
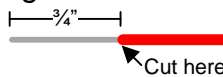

- Strip a 1 3/4" piece of wire and connect lug 3 of the toggle switch to lug 1 of the 100KA pot. Solder the connection at lug 3 of the toggle switch now.

- Strip a 2" piece of wire and connect lug 3 of the 1KL pot to the lower hole of terminal #1. Solder the lower hole of terminal #1 now.

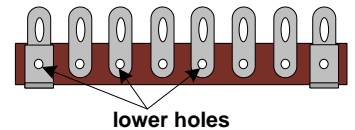

- Connect the 82K resistor to the lower holes of terminals #3 and #4.

- Connect the 10K resistor to the lower holes of terminals #4 and #5. Solder the lower hole of terminal #5 now.

- Strip a 3" piece of wire and connect the lower hole of terminal #4 to the DC jack's positive lug. Solder the lower hole of terminal #4 and the positive lug of the DC jack now.

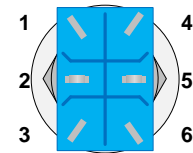

- Strip a 2" piece of wire and connect the lower hole of terminal #3 to the lower hole of terminal #6. Solder both lower holes now.

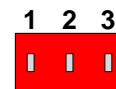

- Strip a 6" piece of wire and connect the lower hole of terminal #7 to lug 1 of the 1KL pot. Solder the lower hole of terminal #7 now.

- Connect the 100K resistor from lug 1 of the 1KL pot to the lower hole of terminal #2. Solder both connections now.

- Strip a 5" piece of wire and connect lug 4 of the footswitch to lug 2 of the 100KA pot. Solder both connections now.

- Strip a 2 1/4" piece of wire and connect lug 2 of the footswitch to the tip lug of the input jack. Solder both connections now.

### Input Jack

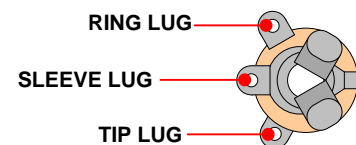

- Strip a 2 1/4" piece of wire and connect lug 5 of the footswitch to the tip lug of the output jack. Solder both connections now.

### Output Jack

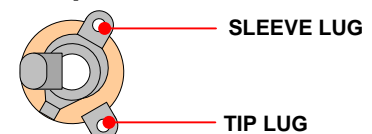



## SECTION 3 – Remaining Components

### Please refer to DRAWING 4. (pg. 11)

Connect and solder all the following components to their respective terminals as listed. *(Make sure that none of the component leads are so close together that it could cause an unintended short).*

- Twist the leads of the two 1N4148 diodes so the black bands are on opposing sides then connect the two diodes from the lug 2 of the toggle switch to lug 3 of the 1KL pot. Solder the connection at lug 2 of the toggle switch now.
- Connect the 10uF capacitor's positive lead to lug 2 of the 1KL pot and the negative lead to lug 3 of the 1KL pot. Solder both connections now.
- Connect the 0.047μF (marked 473J) cap to terminal #5 and lug 1 of the 100KA pot. Solder the connection at lug 1 of the 100KA pot now.
- Connect the 0.1μF (marked 104J) cap to lug 1 of the footswitch and terminal #2. Solder the connection at lug 1 of the footswitch now.
- Connect the 2N3904 transistor to terminals #1, #2 and #3 as listed below. Solder all of the connections at these terminals now.

**Terminals #1:** Emitter

**Terminals #2:** Base

**Terminals #3:** Collector

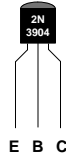

- Connect the 2N3904 transistor to terminals #5, #6 and #7 as listed below. Solder all of the connections at these terminals now.

**Terminals #5:** Collector

**Terminals #6:** Base

**Terminals #7:** Emitter

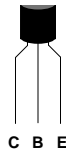

- Locate the battery snap connector. Connect its red wire to the power jack's "positive switch" lug and connect its black wire to the input jack's ring lug. Solder both connections now.

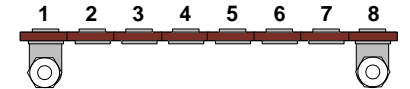
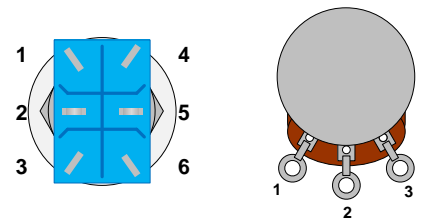
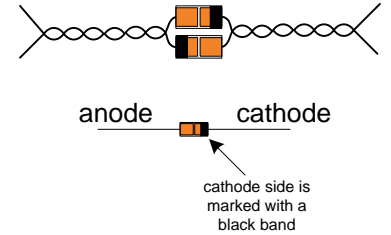

### Input Jack

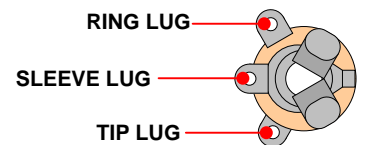

## SECTION 4 – Finishing Up

*It's always a good idea to thoroughly double-check your connections before applying power. This will minimize the risk of damaging components.*

- Fasten the knobs to the potentiometer shafts by tightening their set screws. Slide the toggle cap over the toggle switch. Install a 9 volt battery if needed. Fasten the cover using the four screws provided. Plug your guitar into the input jack on the right side of the pedal. This turns power on when you are not using an AC adapter for power. Plug another cable from the output jack (left side) to your amp's input.
- When using a battery for power, remember to unplug from the input jack of the pedal to turn it off and save battery life.

# DRAWING 1

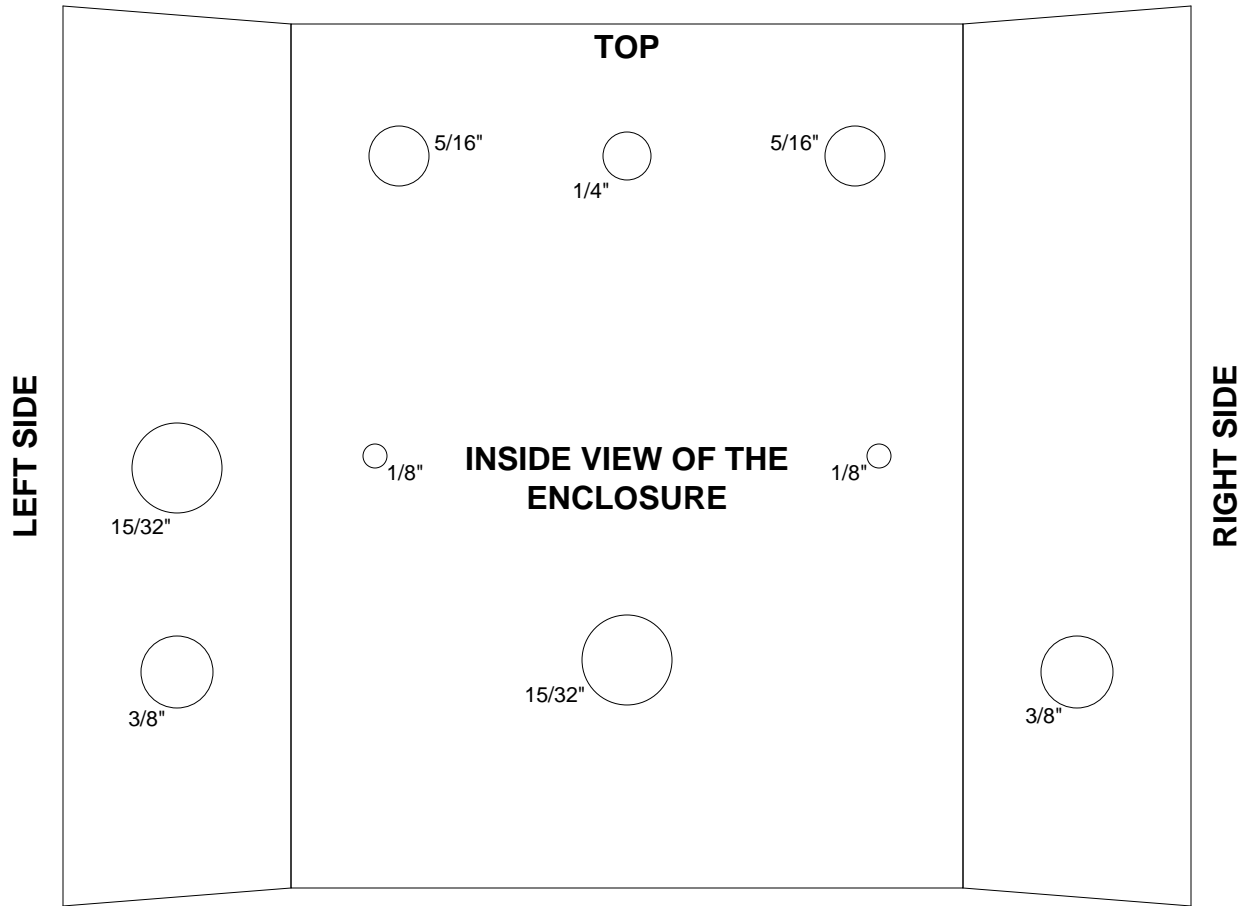

# DRAWING 2

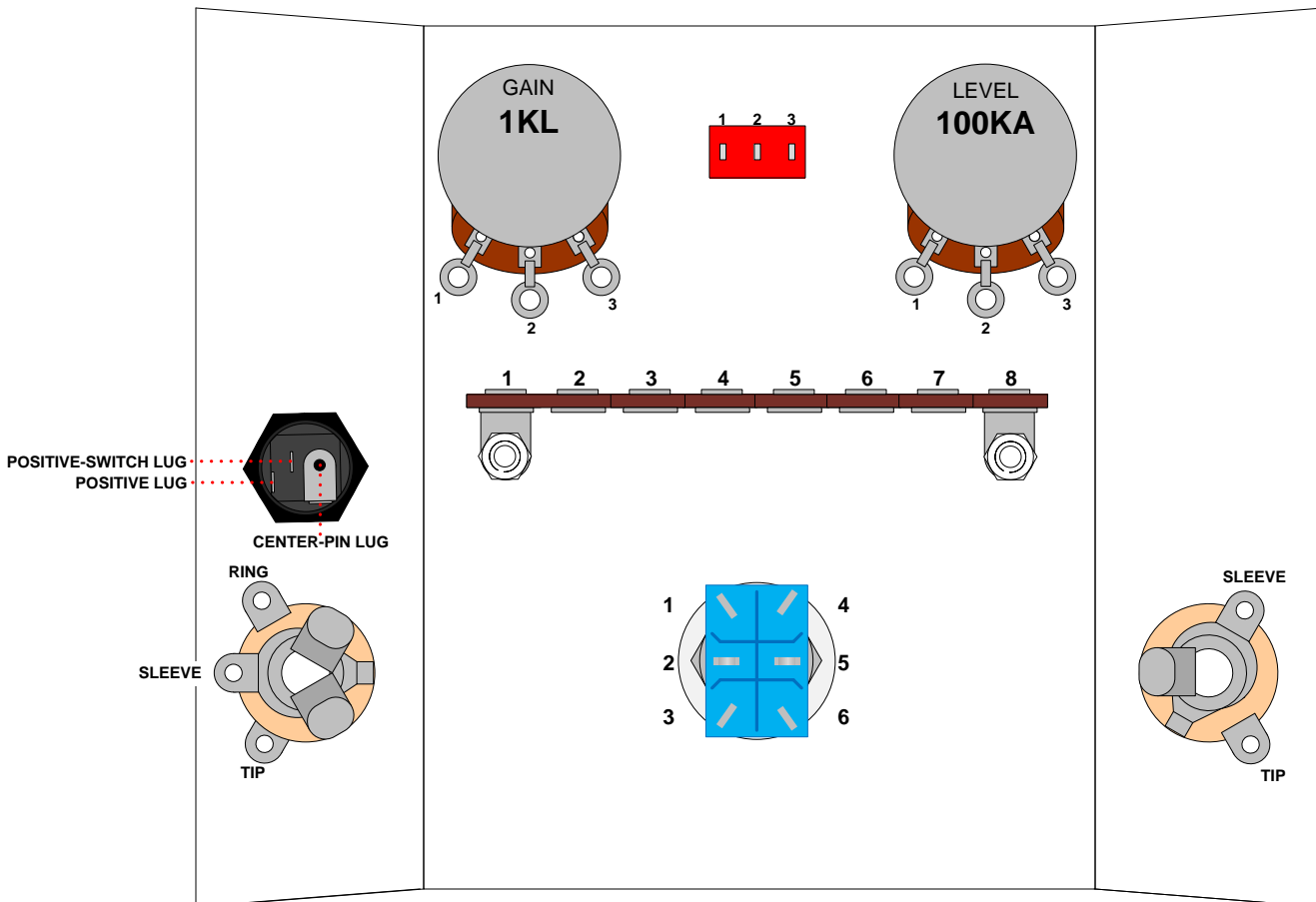

DRAWING 3

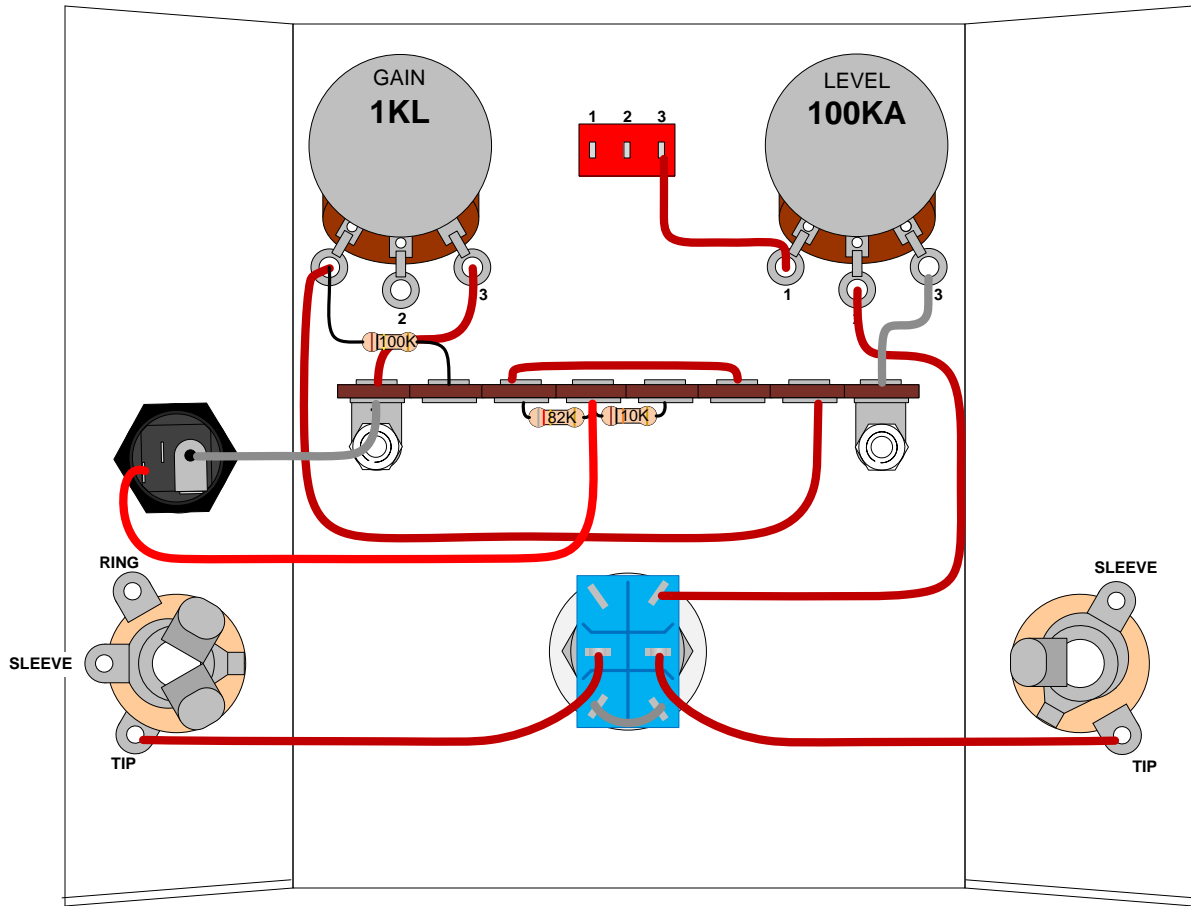

DRAWING 4

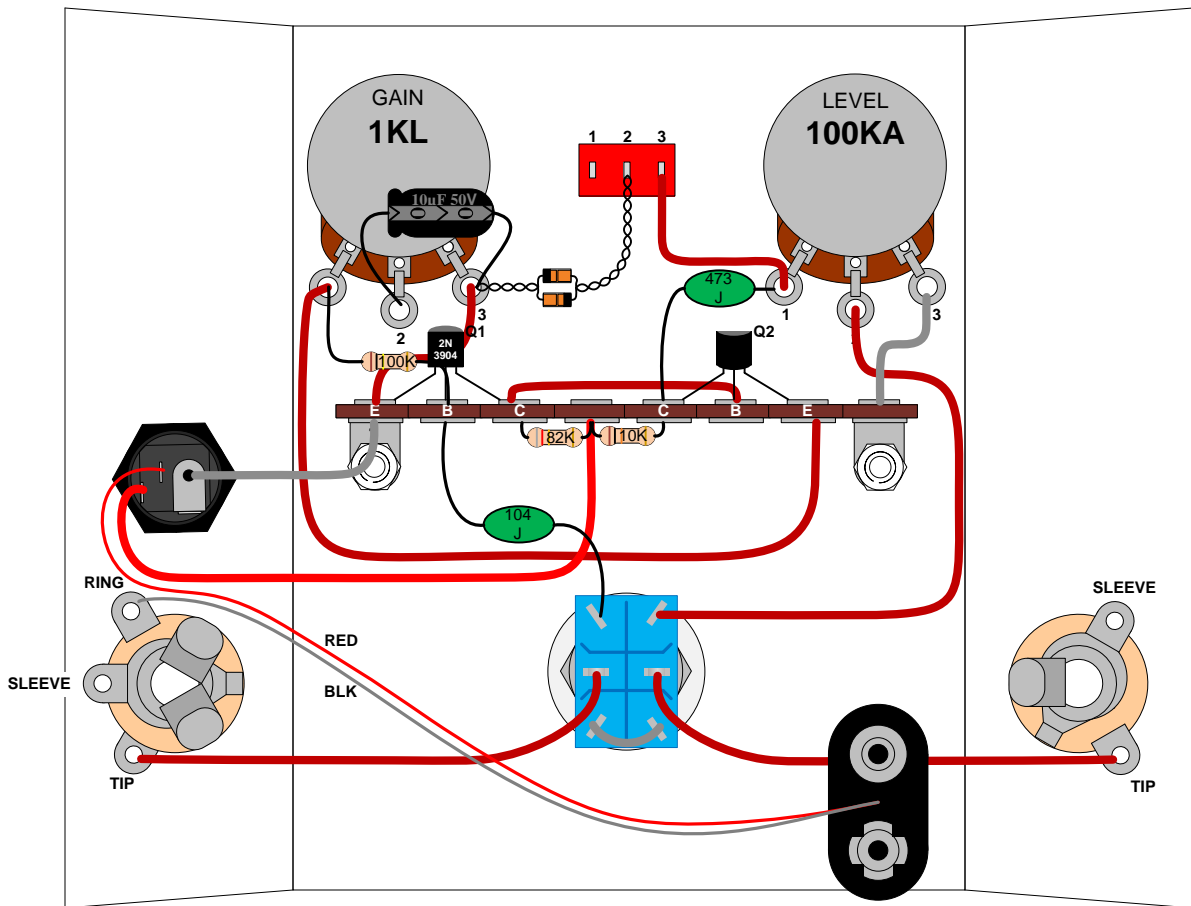

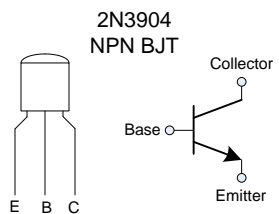
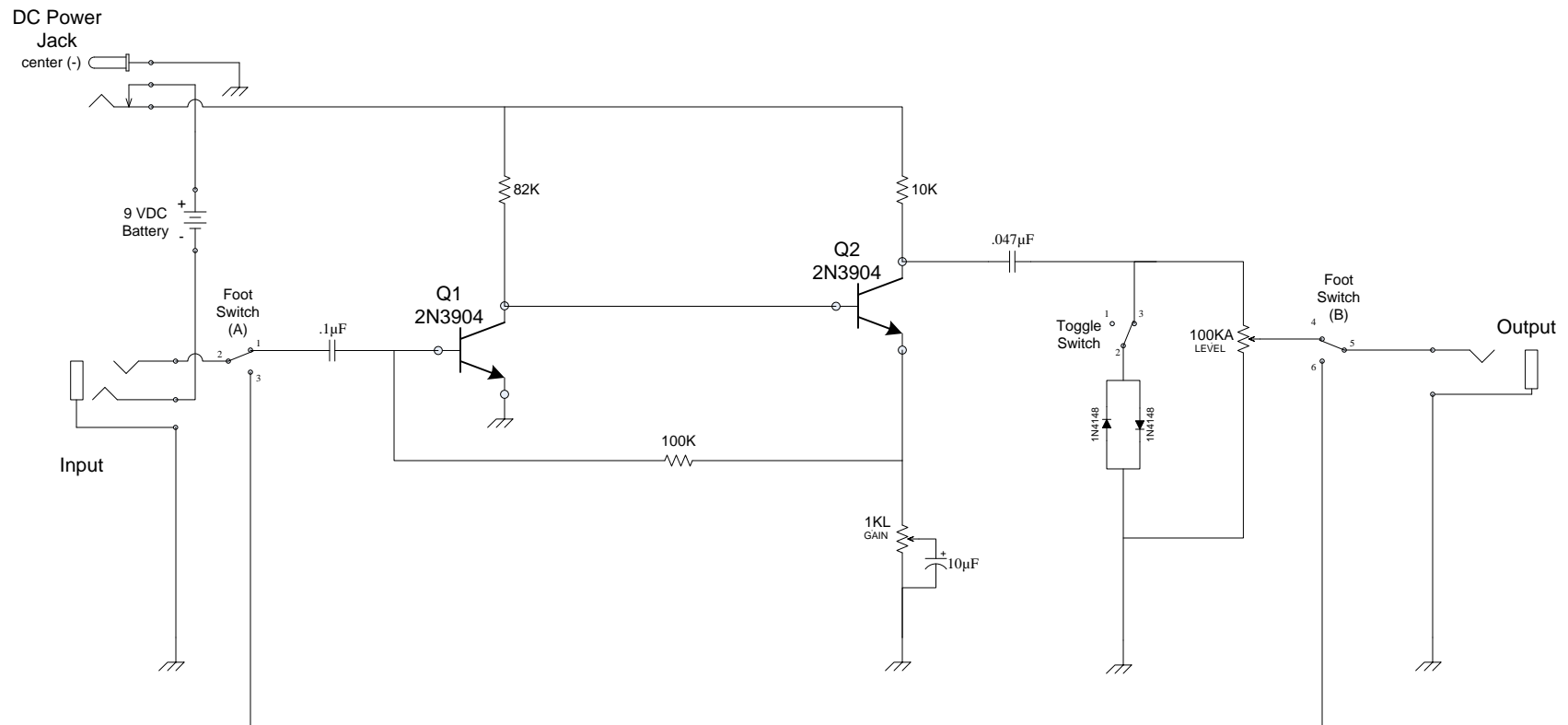

**DPDT Foot Switch**

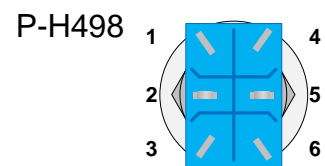

**SPDT Toggle Switch**

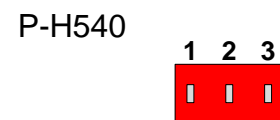

Copyright © 2021 by modkitsdiy.com

**The Rattler Returns (K-901)  
Schematic**

## APPLYING THE STICKER TO MOD PEDAL ENCLOSURES

1.

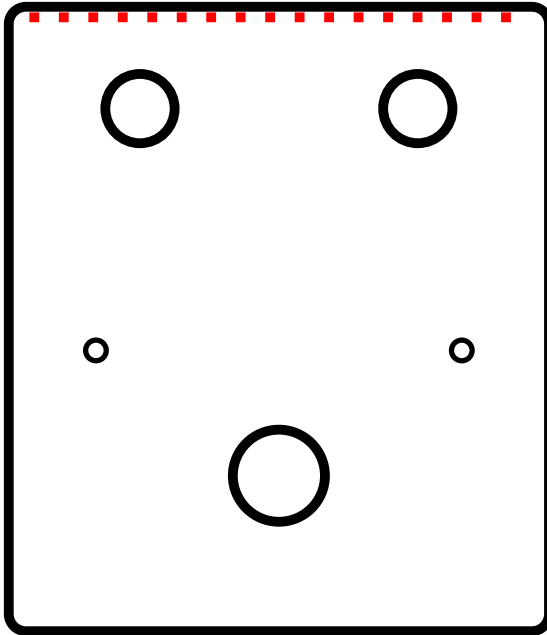

- Locate the top of the pedal as well as the top of the sticker. Page one of the instructions for your kit will have an image of the pedal that can be used for reference.

2.

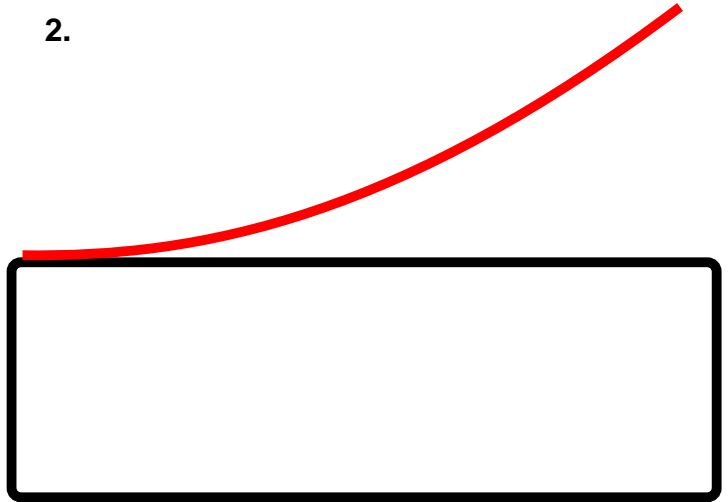

- Peel the backing from the sticker. Carefully line up the top edge of the sticker with the top of the pedal. Press down to apply the sticker only to the edge. Run a finger across the edge to push any air out from beneath the sticker. Continue this motion as you work your way down the pedal until the sticker is fully attached.

3.

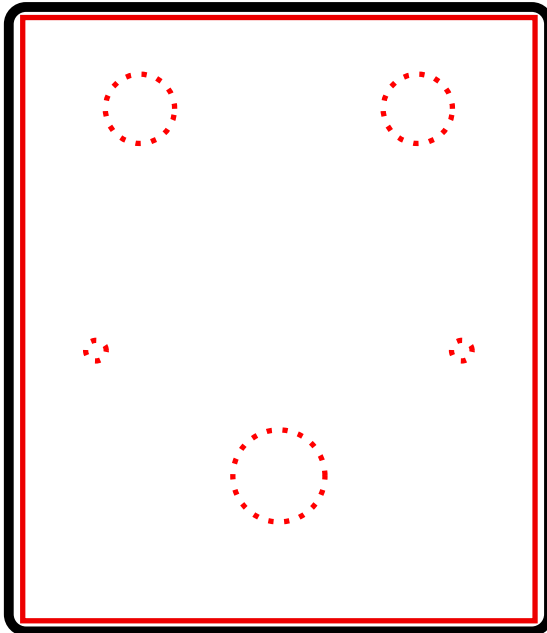

- Locate the holes beneath the sticker and depress them using a fingertip. Be sure that the area of the sticker surrounding the holes is fully adhered to the surface.

4.

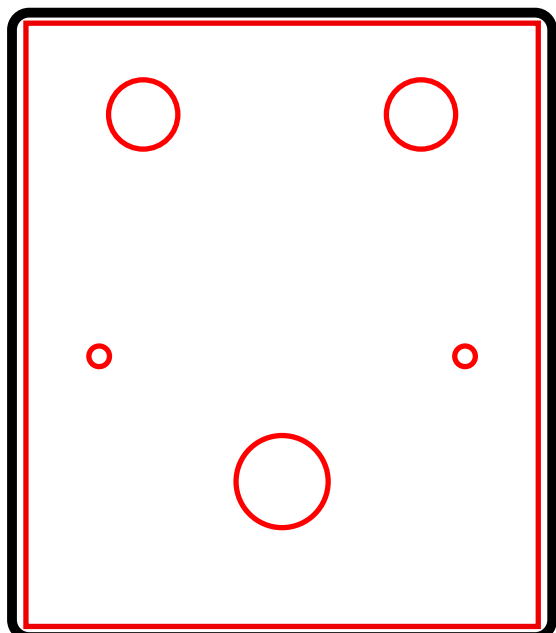

- With an Xacto knife or similar tool, carefully pierce the sticker in the center of each hole. Carefully work the knife from the center of the hole to the edge and begin cutting fully around the edge until the sticker has been fully cleared from the hole.