

NOTE:
Please read all
instructions
carefully before
using this product

Table of Contents

Safety Notice

Hardware Pack

Assembly
Instruction

Parts List

Warranty

Ordering Parts

Model
XJ-6860RW

Retail This
Manual for
Reference

220928

**OWNER'S
MANUAL**

MARCY®

ROWING MACHINE XJ-6860RW

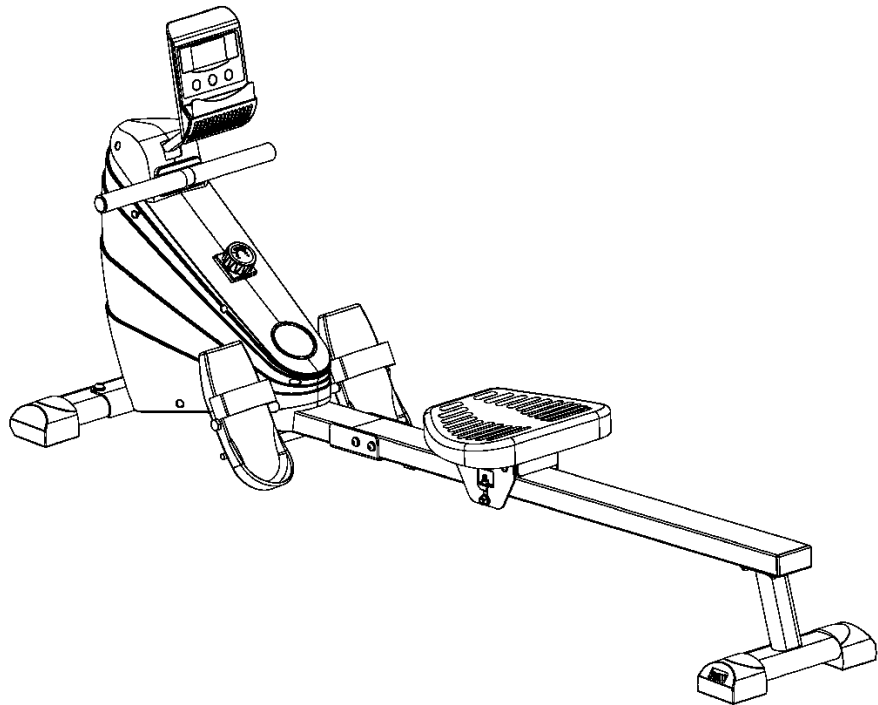

IMPEX® INC.

2801 S. Towne Ave. Pomona, Ca 91766

Tel: (800)999-8899 Fax: (626)961-9966

www.marcypro.com

support@impex-fitness.com

TABLE OF CONTENTS

BEFORE YOU BEGIN	1
IMPORANT SAFETY NOTICES	2
WARNING LABEL PLACEMENT	3
HARDWARE PACK	4
COMPONENT FOR ASSEMBLY	5
CARE AND MAINTENANCE AND STORAGE	7
PARTS LIST	8
EXPLODED DIAGRAM	10
COMPUTER FUNCTIONS AND OPERATION	11
OPERATING NOTES	13
EXERCISE GUIDELINES	14
WARRANTY	16
ORDERING PARTS	16

BEFORE YOU BEGIN

Thank you for selecting the MARCY XJ-6860RW Rowing Machine by IMPEX® INC. For your safety and benefit, read this manual carefully before using the Machine. As a manufacturer, we are committed to provide you complete customer satisfaction. If you have any questions, or find there are missing or damaged parts, we guarantee you complete satisfaction through direct assistance from our factory. To avoid unnecessary delays, *please call our TOLL-FREE customer service number.* Our Customer Service Agents will provide immediate assistance to you.

Toll-Free Customer Service Number

1-800-999-8899

Mon. - Fri. 9 a.m. - 5 p.m. PST

www.marcypro.com

support@impex-fitness.com

IMPORTANT SAFETY NOTICE

PRECAUTIONS

This exercise machine is built for optimum safety. However, certain precautions apply whenever you operate a piece of exercise equipment. Be sure to read the entire manual before you assemble or operate your rower. In particular, note the following safety precautions:

1. **Keep children and pets away from the Rowing Machine at all times. DO NOT leave children unattended in the same room with the Rowing Machine.**
2. Only one person at a time should use the Rowing Machine.
3. If the user experiences dizziness, nausea, chest pain, or any other abnormal symptoms, STOP the workout at once. CONSULT A PHYSICIAN IMMEDIATELY.
4. Position the unit on a clear, leveled surface. DO NOT use the Rowing Machine near water or outdoors.
5. Keep hands away from all moving parts.
6. Always wear appropriate workout clothing when exercising. DO NOT wear robes or other clothing that could become caught in the Rowing Machine. Running or aerobic shoes are also required when using the Rowing Machine.
7. Use the rowing machine only for its intended use as described in this manual. DO NOT use attachments not recommended by the manufacturer.
8. Do not place any sharp object around the Rowing Machine.
9. Disabled person should not use the Rowing Machine without a qualified person or physician in attendance.
10. Before using the Rowing Machine to exercise, always do stretching exercises to properly warm up.
11. Never operate the Rowing Machine if it is not functioning properly.
12. Read all warnings posted on the Rowing Machine.
13. Inspect the Rowing Machine for worn or loose component prior to use. Tighten/replace any loose or wore components prior to use.
14. Care should be taken in mounting or dismounting the Rowing Machine.
15. **This Rowing Machine is for consumer and home use only.**

WARNING: BEFORE BEGINNING ANY EXERCISE PROGRAM, CONSULT YOUR PHYSICIAN. THIS IS ESPECIALLY IMPORTANT FOR INDIVIDUALS OVER THE AGE OF 35 OR PERSONS WITH PRE-EXISTING HEALTH PROBLEMS. READ ALL INSTRUCTIONS BEFORE USING ANY FITNESS EQUIPMENT. IMPEX INC. ASSUMES NO RESPONSIBILITY FOR PERSONAL INJURY OR PROPERTY DAMAGE SUSTAINED BY OR THROUGH THE USE OF THIS PRODUCT. SAVE THESE INSTRUCTIONS.



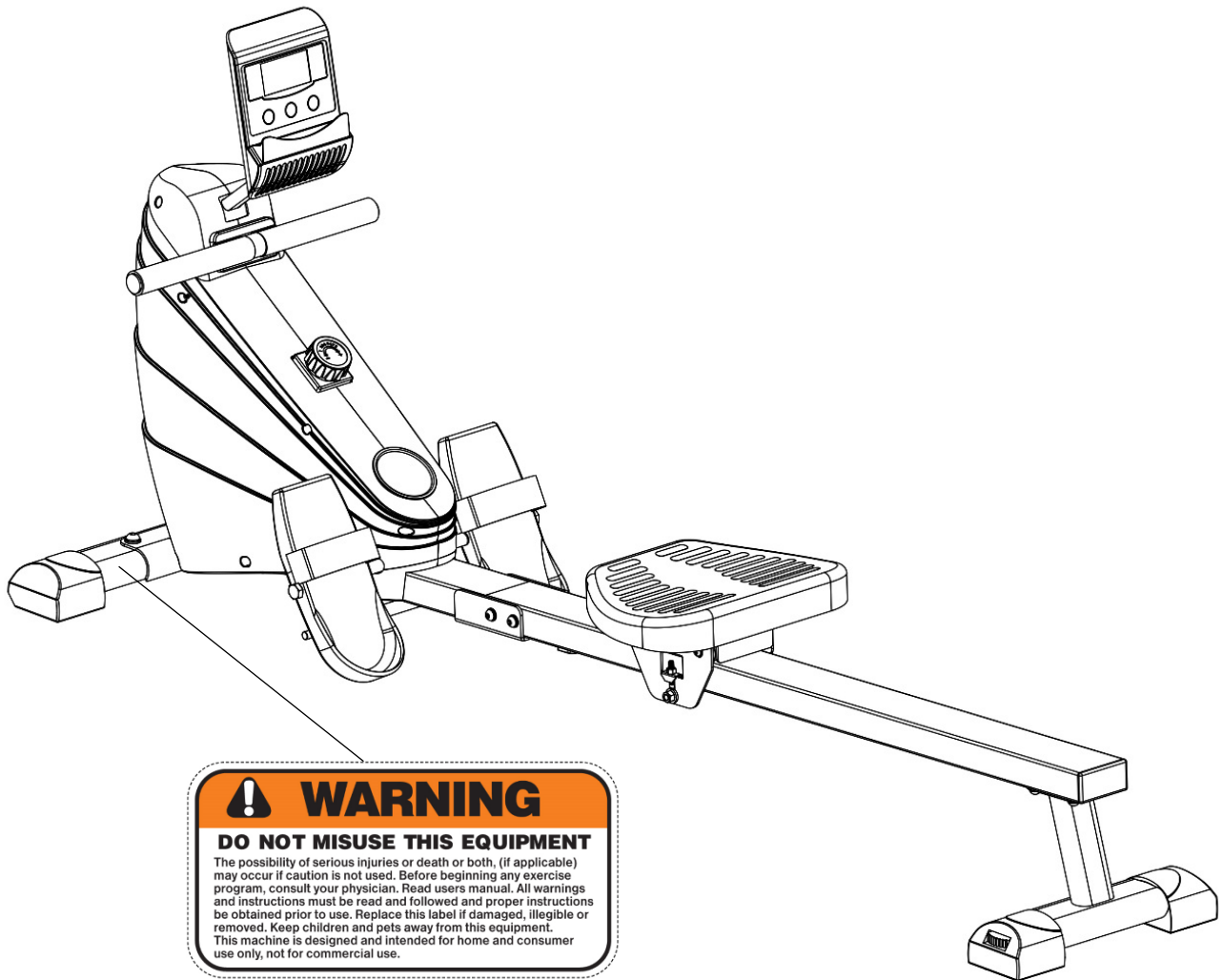





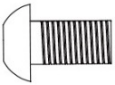

WARNING LABEL PLACEMENT



The Warning Labels and Caution Label shown here have been placed on the Front Stabilizer and Main Frame.

If the labels are missing or illegible, please call customer service at 1-800-999-8899 for replacement. Apply the labels in location shown.

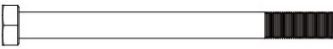
HARDWARE PACK

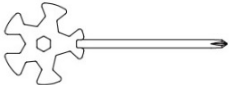
<p>N0.20</p>  <p>Allen Bolt M10×20 ×2</p>	<p>N0.21</p>  <p>Locking Washer φ10 ×2</p>	<p>N0.22</p>  <p>Washer φ10 ×2</p>
<p>N0.23</p>  <p>Allen Bolt M8×15 ×12</p>	<p>N0.24</p>  <p>Locking Washer φ8 ×12</p>	<p>N0.25</p>  <p>Washer φ8 ×12</p>
<p>N0.26</p>  <p>Philips Screw M6×15 ×4</p>	<p>N0.27</p>  <p>Locking Washer φ6 ×4</p>	<p>N0.28</p>  <p>Washer φ6 ×4</p>
<p>N0.29</p>  <p>Hex Bolt M12×140 ×2</p>	 <p>5# Allen Wrech ×1 6# Allen Wrech ×1</p>	 <p>Multi Wrech ×1</p>

COMPONENTS FOR ASSEMBLY

N0.1

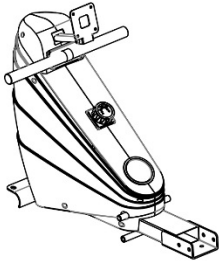

N0.2



N0.3

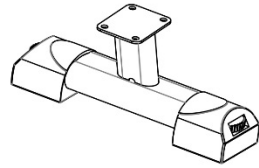

N0.4

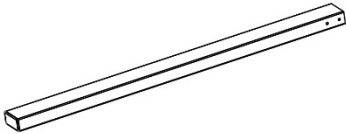

N0.5

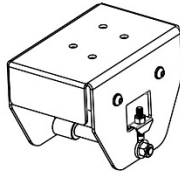

N0.8

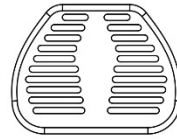

N0.9/10



N0.40

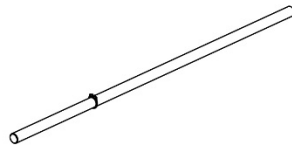

N0.44

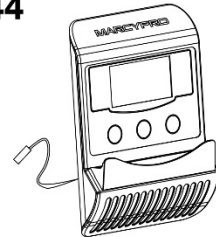

IMPORTANT ASSEMBLY INFORMATION

- ❖ Tools Required for Assembling the Machine: Two Adjustable Wrenches and Allen Wrenches.
- ❖ NOTE: It is strongly recommended that this equipment is assembled by two or more people to avoid possible injury.
- ❖ Ensure **Carriage Bolts** are inserted through the **SQUARE holes** on components that need to be assembled. Attach washer only to end of the Carriage Bolt.
- ❖ Use **Allen Bolts or Hex Bolts** inserted through the **ROUND hole** on components that need to be assembled.
- ❖ Always wait until all bolts are assembled onto the bench before tightening the bolts. Do not tighten each bolt right after it is installed

Fasten Nuts and Bolts

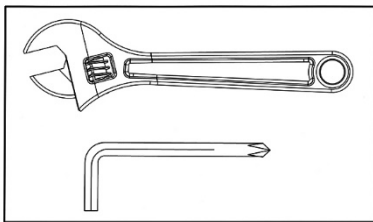

Securely tighten all Nuts and Bolts after all components have been assembled in current and previous steps.

NOTE: Do not over tighten any component with pivoting function.

Make sure all pivoting components are able to move freely.

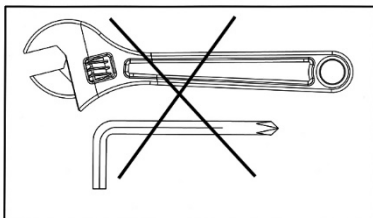

Do not tighten all Nuts and Bolts in this step.

CARE, MAINTENANCE AND STORAGE

1. Inspect and tighten all parts each time you use the Rowing Machine. Replace any worn parts immediately.
2. The Rowing Machine can be cleaned using a damp cloth and mild non-abrasive detergent. Do not use solvents.
3. Store the Rowing Machine IN-DOOR. Excess moisture and water would cause rust on the frame.
4. The Rowing Machine shall be placed at least 24 inches away from the wall or/and any other object such as furniture to provide safe access to and passage around the rowing machine.
5. To avoid possible injury, the help of two or more people is needed when moving the Rowing Machine around.
6. Disposal Instructions – The equipment can be safely disassembled and disposed without unreasonable hazards. Call your local recycle agency regarding details of recycling.
7. **The maximum user weight is 250 lbs.**
8. **Assembled Dimension: 68.5"x19.6"x31.2".**

XJ-6860RW PARTS LIST

Part #	Description	Size	Qty
1	Main Frame		1
2	Front Stabilizer		1
3	Rear Stabilizer		1
4	Slide Rail		1
5	Roller Bracket		1
6	Computer Bracket		1
7	Rowing Handle		1
8	Seat Pad		1
9	Left Pedal		1
10	Right Pedal		1
11	Left Front Stabilizer End Cap		1
12	Right Front Stabilizer End Cap		1
13	Rear Stabilizer End Cap		2
14	Slide Rail End Cap	40×80×1.5	1
15	Slide Rail Stopper		1
16	Rowing Handle End Cap	Φ25×1.5	2
17	Rowing Handle Grip	Φ31×Φ25×190	2
18	Roller Wheel		4
19	Roller Wheel Axel Bushing		2
20	Allen Bolt	M10×20	2
21	Washer	Φ10	2
22	Locking Washer	Φ10	2
23	Allen Bolt	M8×15	12
24	Washer	Φ8	12
25	Locking Washer	Φ8	12
26	Phillips Bolt	M6×15	4
27	Washer	Φ6	4
28	Locking Washer	Φ6	4
29	Hex Bolt	M12×140	2
30	Allen Bolt	M6×45	1
31	Nylon Washer	Φ6	2
32	Aircraft Nut	M6	1
33	Phillips Bolt	M5×10	4
34	Allen Bolt	M6×16	4
35	Washer	Φ18×Φ6.5	4
36	Bushing	Φ14×Φ10×12.5	4
37	Top Roller Wheel Axel		2
38	Roller Wheel Axel Sleeve		2

39	Bottom Roller Wheel Axel		1
40	Pedal Stopper		1
41	Self Tapping Screw	ST4.8×15	2
42	Self Tapping Screw	ST4.2×15	4
43	C-Clip	Φ10	1
44	Computer		1
45	Roller Wheel Adjustment Bolt	M6	2
46	Tension Knob		1
47	Right Shroud		1
48	Left Shroud		1
49	Rowing Handle Rest		1
50	Cup Holder		1
51	Aircraft Nut	M8	2
52	Leveler		1
A	Computer Cable		1
B	Computer Receiver Cable		1

EXPLODED DIAGRAM

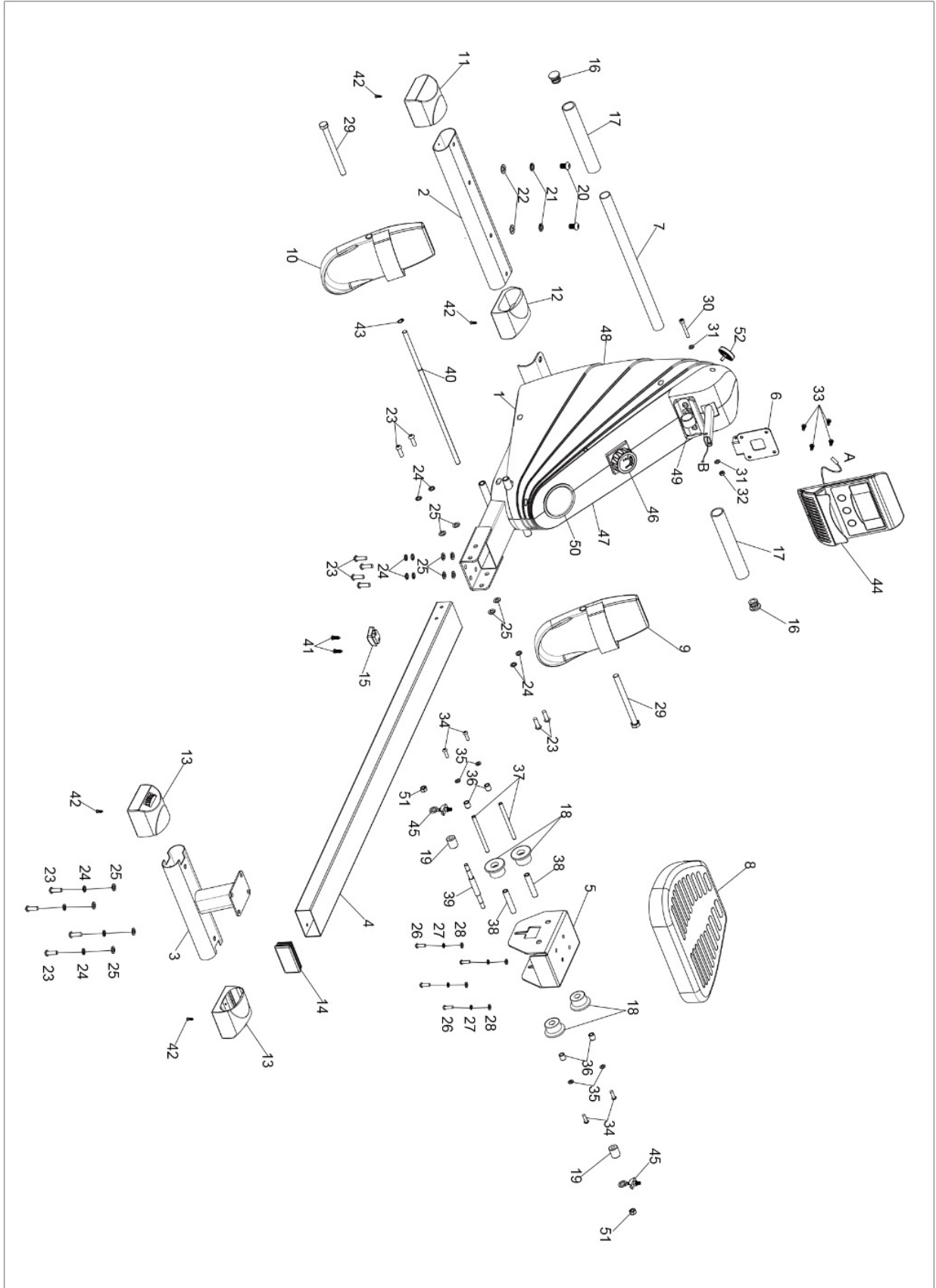

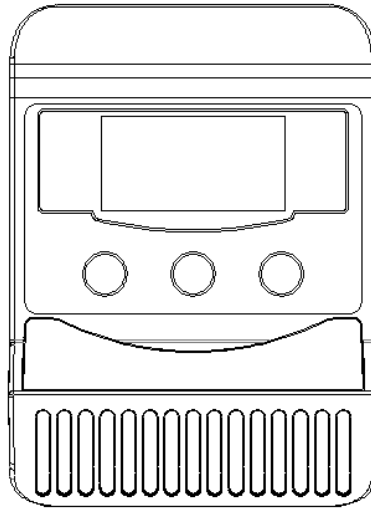

OPERATION PROCEDURES:

1. AUTO ON/OFF

- 1.The system turns on when any key is pressed or when it sensor an input from the speed sensor.
- 2.The system turns off automatically when the rowing machine has detected no activity for 4 minutes.

2.MODE:

1. Pressing Mode allows you to change the Display function on the console.
- 2.To choose the SCAN or LOCK if you do not want the scan mode, press the MODE key when the pointer on the function you want which begins blinking.

3.SET: Press to confirm your target time, count, calories.

4. RESET:

- 1.The key to reset the value to zero by pressing the key.
- 2.The unit can be reset by either changing the batteries or pressing the MODE key for 3

FUNCTIONS:

1.COUNT: Press Mode until Count is displayed. This indicates the number of pulls performed.

2.CALORIE: Press MODE until Calorie is displayed. The number of calories burnt will now be displayed during your workout.

3.TCNT: Total Count. This displays the cumulative number of pulls performed since the last reset.

3. SCAN:
The display will change every 4 seconds scrolling through TCNT,RPM,TIME,COUNT,CAL(calories).

5.RPM: Press Mode until RPM is selected. This displays the current RPM being performed.

6.TIME: Press Mode until TIME is selected. This displays the elapsed time.

BATTERY:

If the display starts to fade, the batteries need replacing.

Function	Auto Scan	Every 4 Seconds
	TCNT	0-9999
	Time	0:00 – 99:59 (Minute: Second)
	Calories	0.0 – 999.9 Cal
	COUNT	0-9999
	RPM	0~9999
Battery type		2 x SIZE – AAA (not included)

1. Remove the battery cover on the back of the computer.
2. Replace 2x1.5V (AAA) batteries.
3. Make sure the batteries are installed correctly and the polarities are correct.
4. The battery life is approx. 10 months under normal usage.
5. When the batteries are removed, all values will reset to zero.

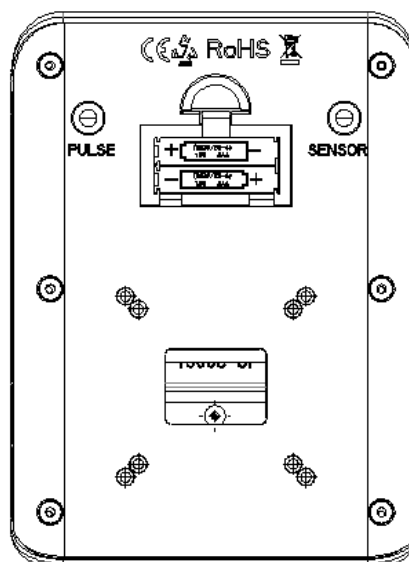

Operating Notes

- To adjust resistance, turn resistance knob (#46) clockwise to increase resistance, counter-clockwise to reduce resistance.
- The feet on the rear stabilizer are adjustable levelers and can be rotated to ensure the rower sits flat on the ground as shown in the diagram. Turn it counter-clockwise to increase height and turn it clockwise to decrease height.
- To store the rower, please lower the computer, and stand the rower upright with the front of the rower facing down. Adjust the leveler (52) on the front of the rower to ensure that the rower is in a stable position and perpendicular to the floor.

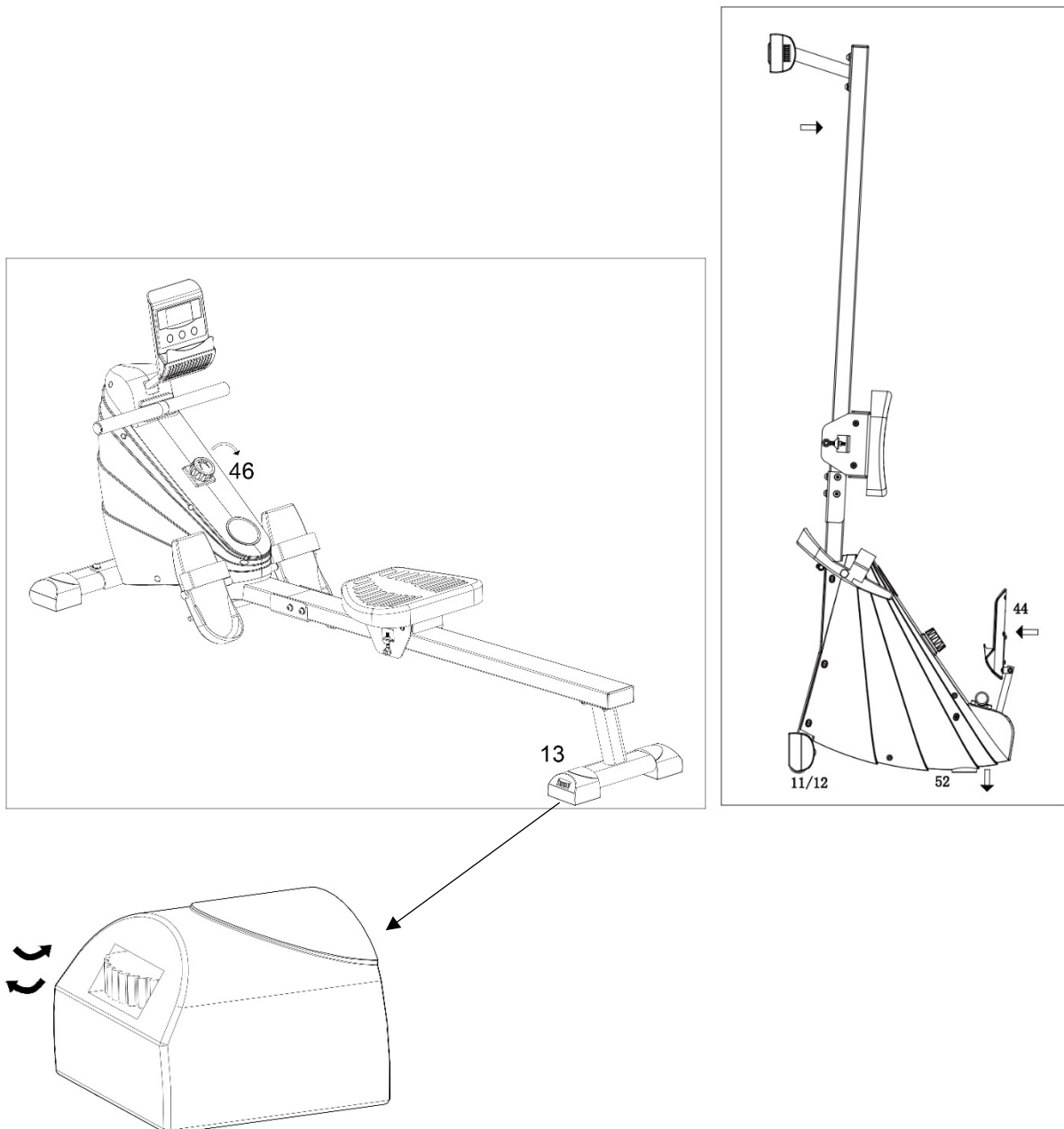

EXERCISE GUIDELINES

Using your Rowing Machine will provide you with several benefits, it will improve your physical fitness, tone muscle and in conjunction with calorie controlled diet help you lose weight.

1. The Warmup Phase

This stage helps get the blood flowing around the body and the muscles working properly. It will also reduce the risk of cramp and muscle injury. It is advisable to do a few stretching exercises as shown below. Each stretch should be held for approximately 30 seconds, do not force or jerk your muscles into a stretch - if it hurts, STOP.

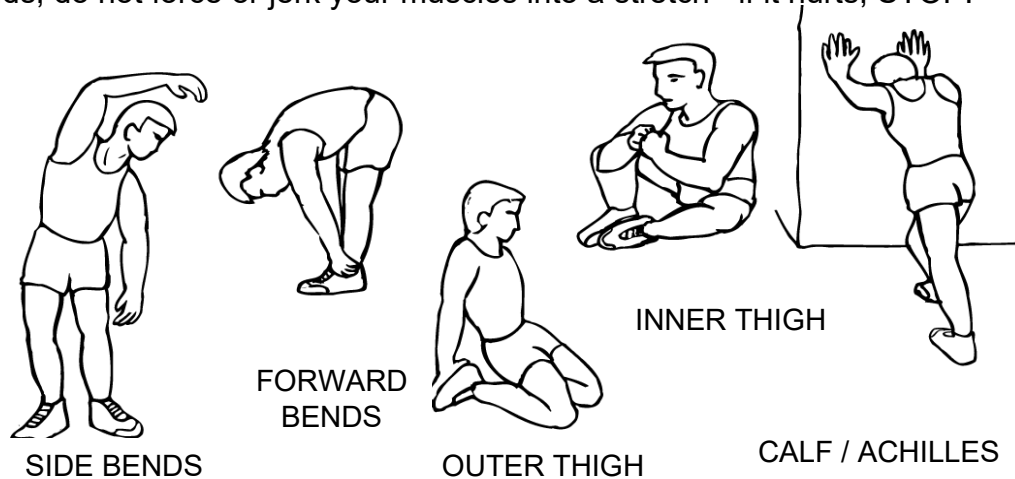

2. The Exercise Phase

This is the stage where you put the effort in. After regular use, the muscles in your legs will become more flexible. Work to your speed but it is very important to maintain a steady tempo throughout. The rate of work should be sufficient to raise your heartbeat into the target zone shown on the graph below.

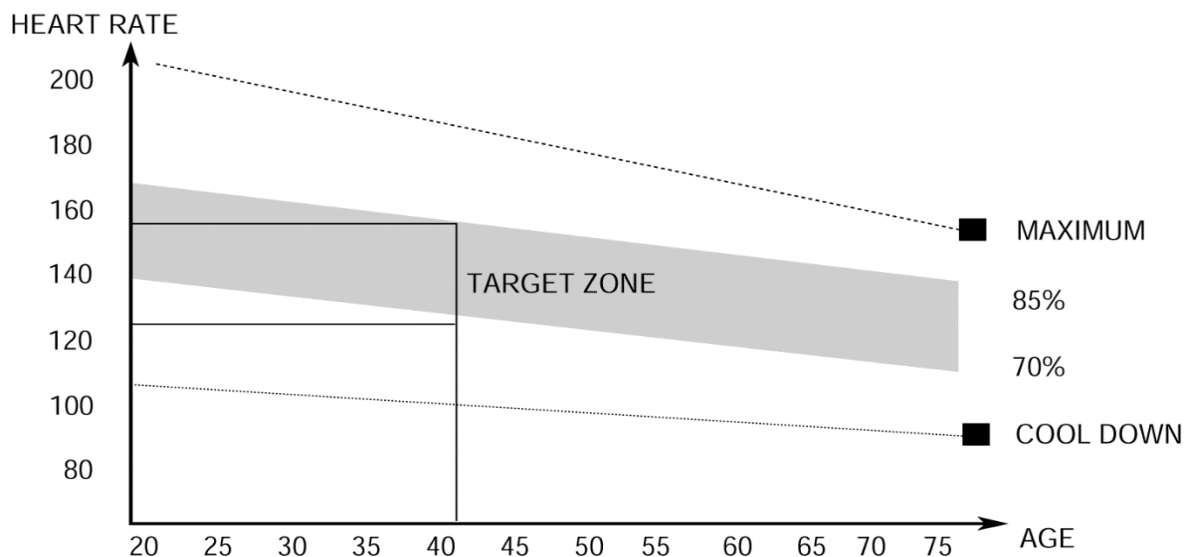

This stage should last for a minimum of 12 minutes though most people start at about 15-20 minutes.

3. The Cool Down Phase

This stage is to let your Cardio-vascular System and muscles wind down. This is a repeat of the warmup exercise e.g. reduce your tempo, continue for approximately 5 minutes. The stretching exercises should now be repeated, again remembering not to force or jerk your muscles into the stretch.

As you get fitter you may need to train longer and harder. It is advisable to train at least three times a week, and if possible, space your workouts evenly throughout the week.

MUSCLE TONING

To tone muscle while on your **Rowing Machine** you will need to have the resistance set quite high. This will put more strain on your leg muscles and may mean you cannot train for as long as you would like. If you are also trying to improve your fitness you need to alter your training program. You should train as normal during the warmup and cool down phases, but towards the end of the exercise phase you should increase resistance making your legs work harder. You will have to reduce your speed to keep your heart rate in the target zone.

WEIGHT LOSS

The important factor here is the amount of effort you put in. The harder and longer you work the more calories you will burn. Effectively this is the same as if you were training to improve your fitness, the difference is the goal.

IMPEX[®] INC.

LIMITED WARRANTY

IMPEX Inc. ("IMPEX[®]") warrants this product to be free from defects in workmanship and material, under normal use and service conditions, for a period of two years on the Frame from the date of purchase. This warranty extends only to the original purchaser. IMPEX's obligation under this Warranty is limited to replacing or repairing, at IMPEX's option.

All returns must be pre-authorized by IMPEX. Pre-authorization may be obtained by calling IMPEX Customer Service Department at 1-800-999-8899. All freights for products return to IMPEX must be prepaid by the customer. This warranty does not extend to any product or damage to a product caused by or attributable to freight damage, abuse, misuse, improper or abnormal usage or repairs not provided by an IMPEX authorized service center or for products used for commercial or rental purposes. No other warranty beyond that specifically set forth above is authorized by IMPEX.

IMPEX is not responsible or liable for indirect, special or consequential damages arising out of or in connection with the use or performance of the product or other damages with respect to any economic loss, loss of property, loss of revenues or profits, loss of enjoyments or use, costs of removal, installation or other consequential damages or whatsoever natures. Some states do not allow the exclusion or limitation of incidental or consequential damages. Accordingly, the above limitation may not apply to you.

The warranty extended hereunder is in lieu of any and all other warranties and any implied warranties of merchantability or fitness for a particular purpose is limited in its scope and duration to the terms set forth herein. Some states do not allow limitations on how long an implied warranty lasts. Accordingly, the above limitation may not apply to you.

This warranty gives you specific legal right. You may also have other rights which vary from state to state. **Register on-line www.marcypro.com**

IMPEX[®] INC.
2801 South Towne Avenue,
Pomona, California 91766

ORDERING REPLACEMENT PARTS

Replacement parts can be ordered by calling our Customer Service Department toll-free at 1-800-999-8899 during our regular business hours: Monday through Friday, 9 am until 5 pm Pacific standard time.
www.marcypro.com
support@impex-fitness.com

When ordering replacement part, always give the following information.

1. Model
2. Description of Parts
3. Part Number
4. Date of Purchase