

QT-FIT8 3X36

QUICKTRONIC FIT 8 | ECG for FL 26 mm



Areas of application

- Open-plan offices, corridors and storage rooms
- Public buildings
- Strip lighting
- Suitable for emergency lighting (DC operation)
- Suitable for luminaires of protection class I

Product benefits

- Long lamp life
- No adverse effect from frequent on/off switching
- Automatic restart after lamp replacement
- Perfect lamp start for applications with motion sensors
- VDE/VDE EMC certified system
- Very high energy efficiency due to cut-off technology

Product features

- Supply voltage: 220...240 V
- Line voltage: 198...264 V
- Line frequency: 50 Hz | 60 Hz
- Lamp start with optimum filament preheating
- Energy Efficiency Index EEI: A2
- Automatic shutdown of defective lamps and at end of life (EoL T.2)
- Lamp operation: to EN 60929
- Safety: to EN 61347-2-3

Product datasheet

Technical data

Electrical data

Input voltage AC	198...264 V
Nominal voltage	220...240 V
Mains frequency	50...60 Hz
Input voltage DC	185...264 V ¹⁾
Operating frequency	40...50 kHz
Max. ECG no. on circuit breaker 10 A (B)	8 ²⁾
Max. ECG no. on circuit breaker 16 A (B)	13 ²⁾
Inrush current	15 A

¹⁾ Minimum voltage for lamp ignition: 198 V, 185...198 V for maximum 1 h

²⁾ Type B

Light technical data

Starting time	2.0 s
---------------	-------

Dimensions & weight

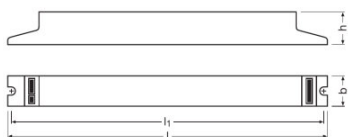

Length	280.0 mm
Width	40.0 mm
Height	28.0 mm
Mounting hole spacing, length	270.0 mm
Product weight	253.00 g
Cable cross-section, output side	0.5...1.5 mm ² ¹⁾
Cable cross-section, input side	0.5...1.5 mm ² ¹⁾

¹⁾ Solid leads

Temperatures & operating conditions

Ambient temperature range	-15...+50 °C
---------------------------	--------------

Product datasheet

Permitted rel. humidity during operation	5...85 %
--	----------

Lifespan

ECG lifetime	50000 h ¹⁾
--------------	-----------------------

¹⁾ At maximum T_c / 10% failure rate

Capabilities

Suitable for fixtures with prot. class	I
End of lamp life safety shutdown	EOL T.2

Certificates & standards

Approval marks – approval	VDE / VDE-EMC / ENEC 10 / CE
EEI – Energy Label	A2
Standards	Acc. to EN 61347-2-3/Acc. to EN 60929/Acc. to EN 55015:2006 + A1:2007/Acc. to EN 61000-3-2/Acc. to EN 61547
Protection class	I
Type of protection	IP20



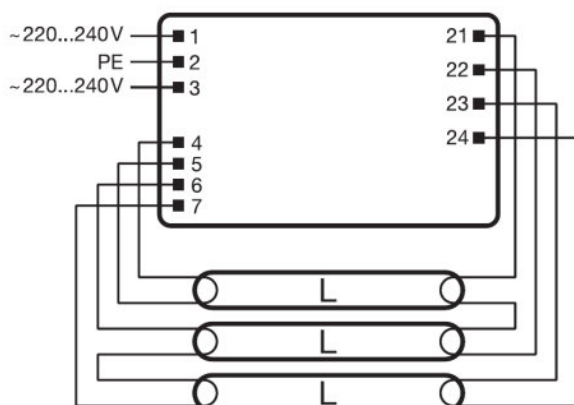





Wiring Diagram



Wiring diagram

[Download Data](#)

Product datasheet

File	
	Product Family Datasheet 336477_Family data sheet QT-FIT8
	Brochures 333871_LUMILUX ES and OSRAM DULUX D ES – Take a good look at
	Certificates 334974_ENEC-Marks approval
	Certificates 335097_INOTEC
	Certificates 335150_CEAG
	Certificates 335169_Manufacturer's declaration – LampECG combinations: Frequent switching
	Certificates 592319_EAC certificate for Quicktronics QT
	Certificates 504209_VDE-EMC-Certificate QT-Fit8
	Declarations of conformity 334775_Declaration of conformity

Logistical Data

Product code	Product description	Packaging unit (Pieces/Unit)	Dimensions (length x width x height)	Volume	Gross weight
4008321512055	QT-FIT8 3X36	Shipping carton box 20	311 mm x 212 mm x 131 mm	8.64 dm ³	5333.00 g

The mentioned product code describes the smallest quantity unit which can be ordered. One shipping unit can contain one or more single products. When placing an order, for the quantity please enter single or multiples of a shipping unit.

Disclaimer

Subject to change without notice. Errors and omission excepted. Always make sure to use the most recent release.

QT-FIT8 3X36

QUICKTRONIC FIT 8 | ECG for FL 26 mm

Product name	Lamp group	Nominal current	Nominal wattage + Power loss	Luminous flux at 35 °C	Number of lighting outlets
QT-FIT8 3X36	L 32 W ES	0.434 A	100.00 W	2500 lm	3
	L 36 W	0.48 A	105.00 W	3500 lm	3
	L 36 W XT	0.48 A	105.00 W	3500 lm	3
	L 58 W XT	0.48 A	105.00 W	3500 lm	3