EC9555

La Specialista

OPERA

COFFEE MACHINE

Instruction for use

MACCHINA DA CAFFÈ

Istruzioni per l'uso

MACHINE À CAFÉ

Mode d'emploi

SIEBTRÄGERMASCHINE

Bedienungsanleitung

CAFETERA

Instrucciones de uso

ماكينة القهوة

تعليمات الاستخدام

For more details please check out the

De'Longhi How to videos



More languages available here



De'Longhi

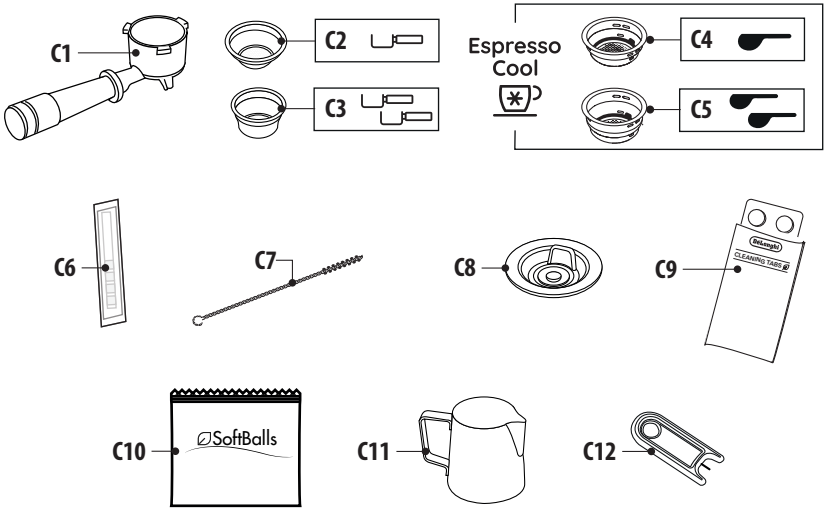
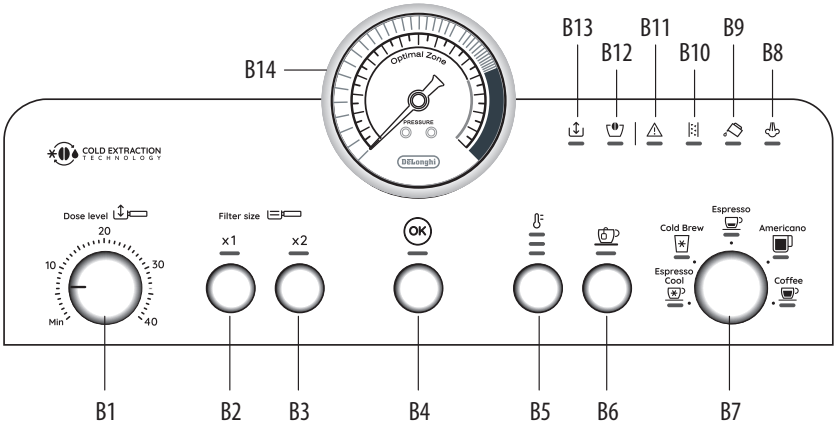

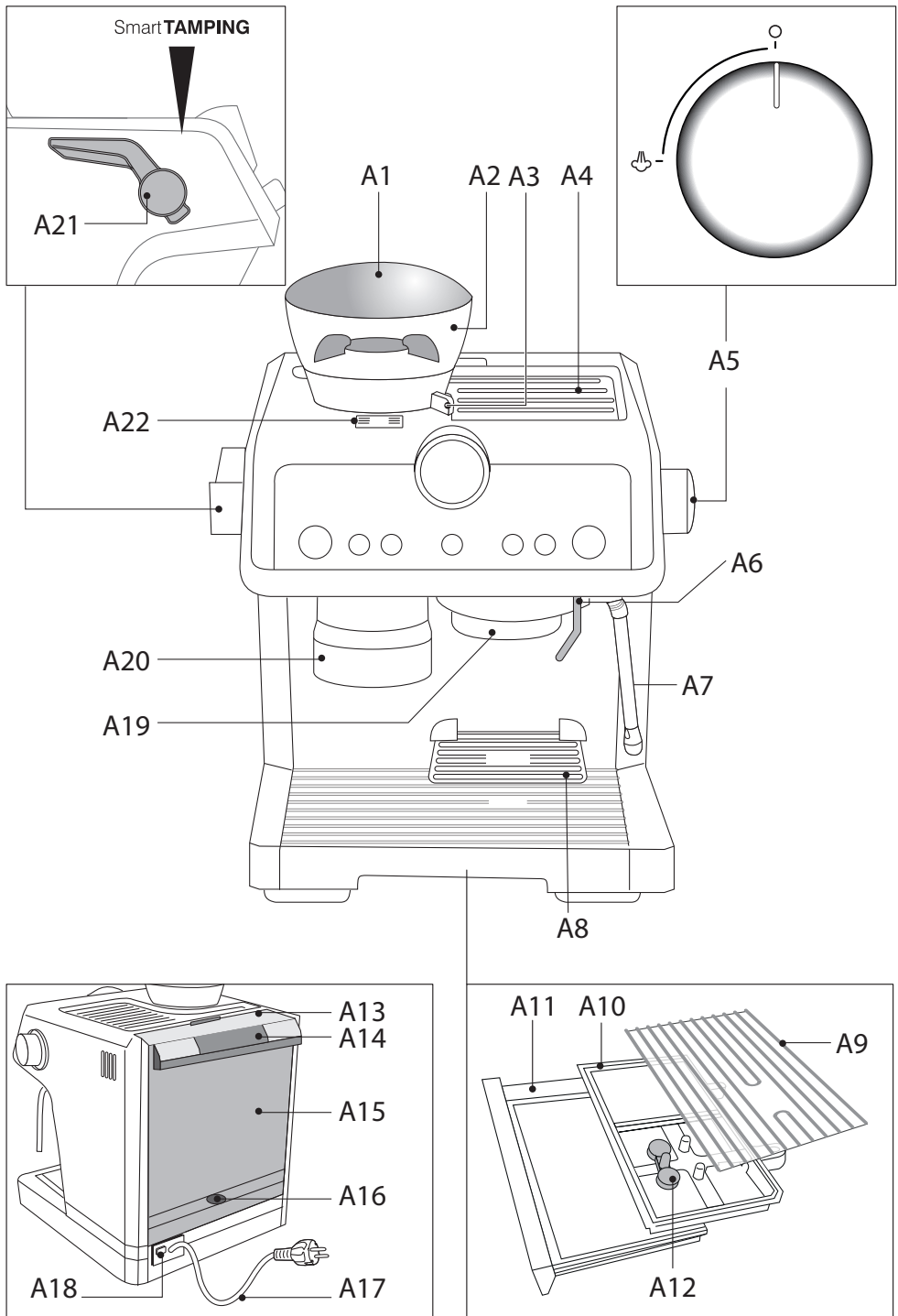

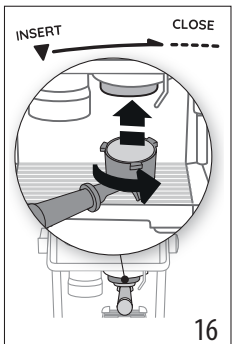
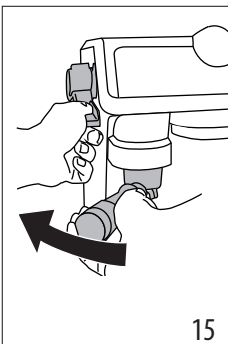
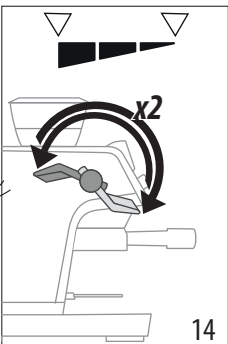
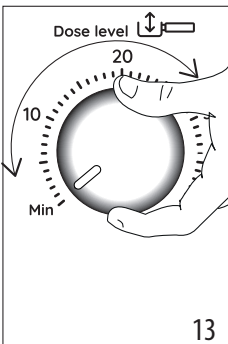
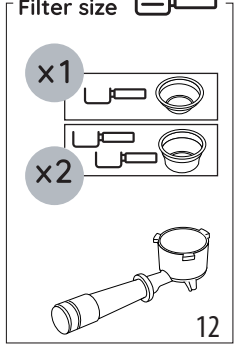
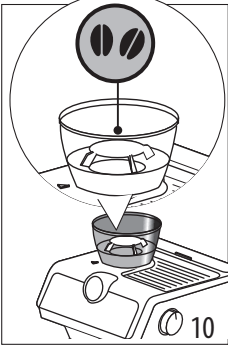
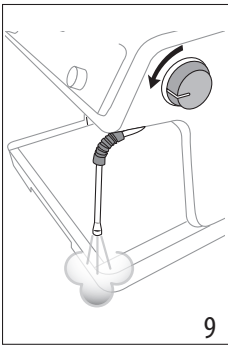
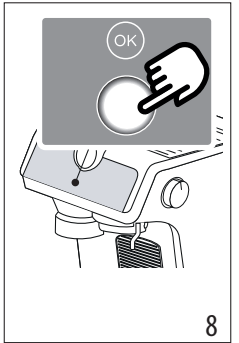
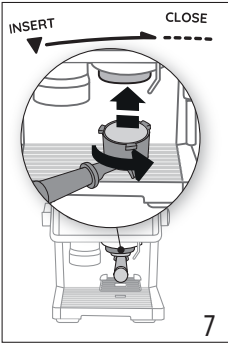
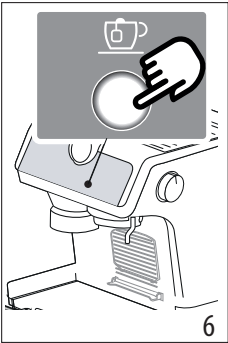
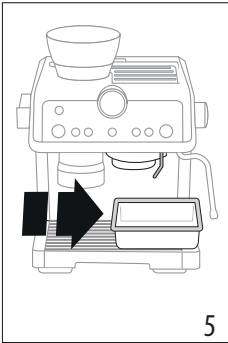
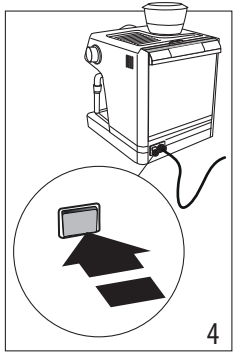
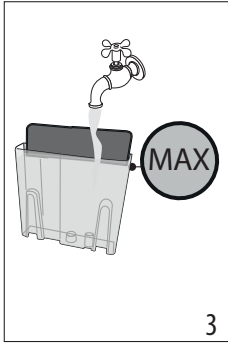
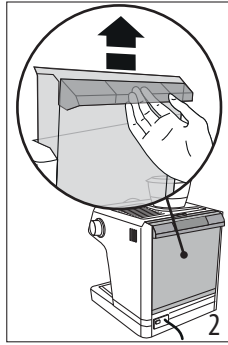
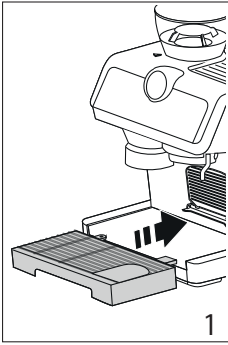

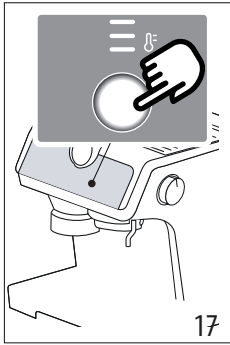

17

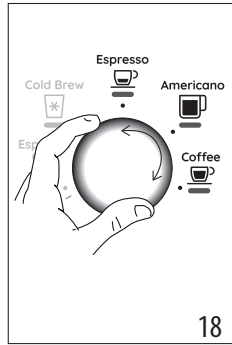

18



19



20

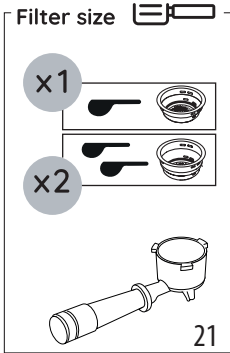

21



22



23

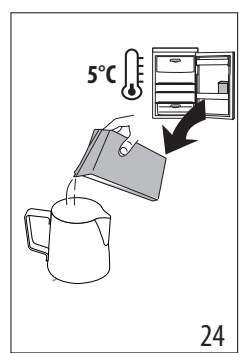

24

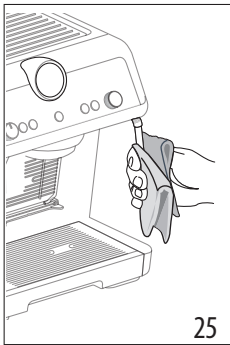

25

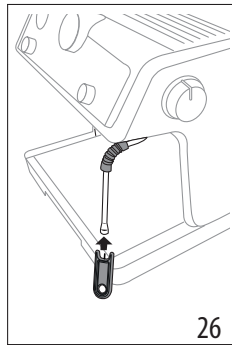

26

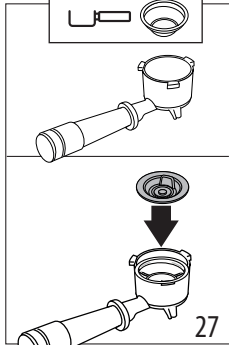

27

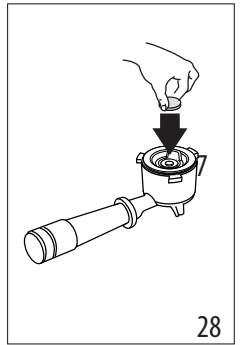

28

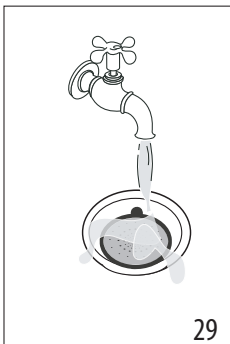

29

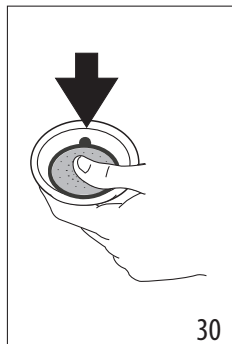

30

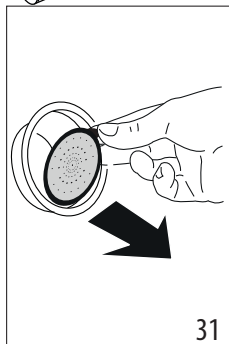

31

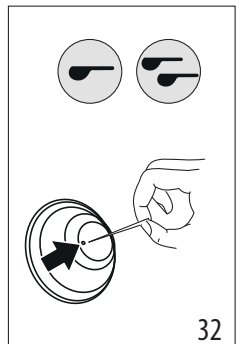

32

Before using the machine, always read the safety warnings.

1. DESCRIPTION

1.1 Description of machine - A

- A1. Beans hopper lid
- A2. Beans hopper
- A3. Grind selector (fine to coarse)
- A4. Cup tray
- A5. Steam dial
- A6. Hot water spout
- A7. Steam wand
- A8. Cup grille for espresso
- A9. Cup grille for glasses or mugs
- A10. Drip tray grille
- A11. Drip tray
- A12. Drip tray water level indicator
- A13. Water tank lid
- A14. Water tank pull handle
- A15. Water tank
- A16. Water softener filter housing
- A17. Power cord
- A18. Main switch (ON/OFF)
- A19. Coffee spout
- A20. Coffee grinder outlet (tamping station)
- A21. Tamper lever
- A22. Coffee grinder funnel access flap

1.2 Description of control panel - B

- B1. Ground coffee quantity dial
- B2. "1x" button: selection of 1-coffee filter
- B3. "2x" button: selection of 2-coffee filter
- B4. "OK" button: used to deliver drink / confirm selection / switch the machine on from standby
colour white: delivery of hot drinks
colour blue: delivery of cold drinks
- B5. "Coffee temperature" button
- B6. "Hot water" button
- B7. Drink selection dial:
 - Espresso Cool
 - Cold Brew
 - Espresso
 - Americano
 - Coffee
- B8. "Steam delivery" indicator
- B9. "No water" indicator
- B10. "Descal" indicator
- B11. Colour orange: clean coffee spout
colour red: general alarm
- B12. "Beans hopper" indicator
- B13. "Anti clogging" indicator
- B14. Pressure gauge

1.3 Description of accessories - C

- C1. Portafilter
- C2. 1 cup filter
- C3. 2 cup filter

Dedicated filters for **Espresso Cool**  :

- C4. 1 cup filter
- C5. 2 cup filter
- C6. "Total Hardness Test" strip
- C7. Tube brush
- C8. Coffee spout cleaning accessory
- C9. Cleaning tabs: cleaning aids for the coffee spout
- C10. Softballs
- C11. Milk carafe
- C12. Steam wand cleaning needle

1.4 Optional cleaning accessories recommended by the manufacturer

For more information, go to www.delonghi.com.

ECO MULTICLEAN  **Cleaner**
EAN: 8004399333307

ECODECALK  **Descaler**

2. PREPARING THE MACHINE

Wash all accessories with warm water and washing-up liquid, then proceed as follows:

1. Position the drip tray (A11) together with the cup grille (A9) and drip tray grille (A10) (fig. 1);
2. Remove the water tank (A15) (fig. 2) and fill with clean cold water, taking care not to exceed the MAX level (fig. 3).
3. Reposition the tank in the machine.

Important: *Never operate the machine without water in the tank or without the tank.*

Please note: *It is advisable to select the appropriate water hardness setting as soon as possible, following the instructions in section "7. Settings menu".*

3. SETTING UP THE MACHINE

1. Plug into the mains socket. Press the main switch (A18) (fig. 4).
2. Place a container of at least 100 ml capacity under the hot water spout (next to the coffee spout (A19)) (fig. 5).
3. Press the  button next to the indicator (fig. 6): delivery will start and then stop automatically. Empty the container.
Before using the coffee maker, the internal circuits of the machine must be rinsed. Proceed as follows:
4. Attach the portafilter (C1) complete with filter to the machine: to ensure it is attached correctly, align the handle of the portafilter with "INSERT" (fig. 7), then turn the handle to the right until aligned with the "CLOSE" position.

- Place a container under the portafilter and the steam wand (A7);
- Press the OK button (B4): delivery will start (fig. 8);
- When delivery has finished, turn the steam dial (A5) (fig. 9) and release the jet for a few seconds so as to rinse the steam circuit: to ensure best possible results, repeat the operation 3 or 4 times.

The machine is ready for use.

Please note: It is also advisable to rinse the internal circuits if the machine is not used for a prolonged period.

When using the machine for the first time, 4-5 cups of coffee will need to be made before it gives satisfactory results. Pay particular attention to the quantity of ground coffee in the filter ((C2) or (C3)) (see instructions in section "4.1 Step 1 - Grinding"). Proceed as described in section "The "perfect dose"".

4. MAKING COFFEE



Rinsing the filter and the portafilter

To guarantee the cleanliness and the correct temperature of the entire coffee circuit:

- before preparing the dose ("4.1 Step 1 - Grinding" and "4.2 Step 2 - Tamping"), attach the portafilter to the coffee spout (fig. 7);
- press the OK button (B4): the machine delivers water (hot or cold, depending on the drink selected).
- next, to ensure you pull the perfect shot, dry the filter and portafilter with a cloth before preparing the dose.

Rinse the glass or cup

If a hot drink is being prepared, to ensure the coffee will be at the optimum temperature:

- position the cup/glass under the hot water spout (A6);
- run a rinse cycle by pressing the  button (B6);
- stop the flow of water by pressing the  button a second time;
- next, to ensure you pull the perfect shot, empty and dry the glass/cup before preparing the dose.

4.1 Step 1 - Grinding

- Put coffee beans in the hopper(A2) (fig. 10). It is best to grind only a quantity of beans sufficient for immediate use, so that the coffee will always be fresh.
- Generally speaking, darker roasts will require a coarser grind, whereas beans presenting a lighter coloured roast need to be ground more finely. When using coffee beans for the first time, start with the factory default setting of 9 (fig. 11) and make sure that the dose is correct (see "The "perfect dose""). Make an espresso and, depending on the outcome, be prepared to adapt it. If the brew is too strong (coffee dispensed too slowly), the grinder needs to be adjusted to a coarser setting. If the brew is too weak (coffee

dispensed too quickly), the grinder needs to be adjusted to a finer setting.

Please note: A setting between 5 and 11 is recommended for most coffees. A setting between of 1 and 4 is very fine and should be used with special coffees only (light roast)

- Place one of the coffee filters (C2) or (C3) in the portafilter (C1) (fig. 12);

Please note:

When preparing  Espresso Cool, use the dedicated filters provided for this drink (see section "4.5 Step 3 - Delivery of Espresso Cool").

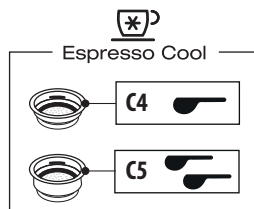

- Set the quantity by adjusting the dial (B1), starting from the minimum position (fig. 13).

Refer to the section "Adjusting the quantity of ground coffee in the filter" for further indications.

- Attach the portafilter to the outlet of the coffee grinder (A20), aligning it with the "INSERT" mark, then turn the portafilter to the right.
- When using the 1 cup filter (C2) or (C4), press the "X1" button (B2). When using the 2 cup filter (C3) or (C5), press the 2x button (B3): this will also double the quantity of espresso coffee delivered. The grinding step begins and stops automatically.

Adjusting the quantity of ground coffee in the filter

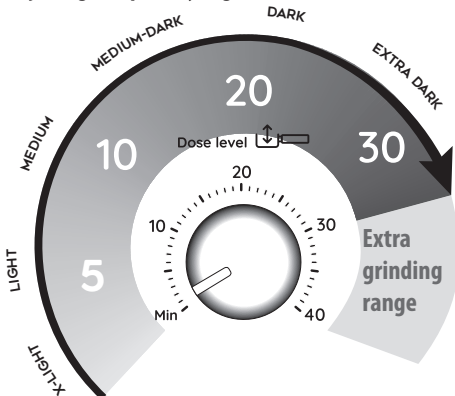

Different varieties of coffee bean give different results when ground: consequently, the initial adjustment of the dosage requires special care.

This illustration shows how to regulate the dosage, based on the roast colour: this should be taken as a general guide, given that in practice, the final adjustment can vary according to the composition of the beans.

1. Set the dosage starting from the minimum position.
2. Looking at the roast colour of your particular beans, turn the dial slowly to find the right adjustment.

4.2 Step 2 - Tamping

1. Following the grinding step, bring the tamping lever (A21) down completely (keeping the portafilter in position) (fig. 14). For best results, repeat the tamping stroke twice, returning the lever to the at-rest position each time.
2. Keep the tamping lever fully down when removing the portafilter (fig 15). When done, return the lever to the at-rest position.
3. Having checked that the dosage is as required (see “The “perfect dose””), attach the portafilter to the coffee spout (A19) (fig. 16).

Please note:

- If residual traces of coffee are left along the edges of the filter after tamping, this does not affect the quality of the brew or the resulting drink.
- Draw the portafilter away from the tamper with the lever still down, so that the surface of the compacted coffee stays smooth.

The “perfect dose”

- The coffee filters have a mark inside to identify the level for perfect dose.

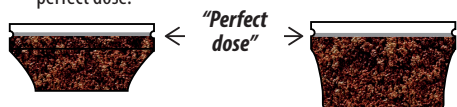

The filter should be filled up to the level of the mark.

- Make sure the coffee is at the right level after tamping. It might be necessary to adjust the level a few times using the dial (B1) before the ideal dosage is achieved.
- If your coffee is over or under extracted and the dose is within the perfect dose range, adjust the grinder settings finer or coarser (see “4. Making coffee”). Over extracted coffee (pouring too slowly) needs coarser grind. Under extracted coffee (pouring too fast) needs finer grind

Tamping pre-ground coffee

For preparation with pre-ground coffee:

1. add the pre-ground coffee into the filter;
2. attach the portafilter to the grinder outlet;
3. with the filter-holder attached, lower the tamping lever (A21) as far as it will go;
4. detach the portafilter;
5. press the button for the desired number of cups (1x or 2x).

4.3 Step 3 - Delivery of hot drinks

1. Select the temperature (fig. 17) (see “The temperature for brewing hot drinks”).
2. Select the desired drink (fig. 18). If the drink has been programmed (see section “6. Programming drink quantities”), the drink light blinks briefly.
3. Press OK (B4) to start brewing (fig. 8) (pre-infusion and infusion). Delivery of the coffee will stop automatically.

The temperature for brewing hot drinks

The temperature of the water is controlled throughout the preparation process to ensure its stability during extraction. The Specialista Prestigio offers 3 infusion temperatures* set in a range between 92 and 96 °C.

Depending on the variety and roasting degree of the beans, a different temperature is recommended: Robusta beans and dark roast usually require lower temperatures. Arabica beans and lighter roast usually require higher brewing temperatures. Use the table below as reference and adjust to taste

Temperature level	Corresponding indicator	Roast colour
MIN		Dark
MED		Medium-dark
MAX		Light - medium

- * This is the temperature of the water in the thermoblock. It is therefore not the temperature of the drink in the cup or the temperature of the drink at the moment of release from the outlets of the portafilter.

4.4 Step 3 - Delivery of Cold Brew

- Select Cold Brew (fig. 19): the OK indicator (B6) turns blue to show that a cold drink has been selected.
4. Place 1 or 2 ice cubes in the glass (fig. 20).
 5. Press OK to begin delivery. Delivery will stop automatically.

Please note:

- The pressure gauge does not swing around to high values: there is no pressure involved in this preparation.
- **Cold Extraction Technology:** to ensure best possible results when preparing Cold Brew drinks, fill the water tank with fresh drinking water.

4.5 Step 3 - Delivery of Espresso Cool

When preparing Espresso Cool, use the dedicated filters (C4) or (C5) provided for this drink (fig.21).

Prepare the “perfect dose” as described in “4.1 Step 1 - Grinding” and “Adjusting the quantity of ground coffee in the filter”.

Then proceed as follows:

1. Select Espresso Cool (fig. 22): the OK indicator (B6) turns blue to show that a cold drink has been selected.
2. Place 2 or 3 ice cubes in the glass (fig. 23).
3. Press OK to begin delivery. Delivery will stop automatically.

Please note:

- **Cold Extraction Technology:** to ensure best possible results when preparing Cold Brew drinks, fill the water tank with fresh drinking water.

5. MAKING MILK-BASED DRINKS

5.1 Frothing the milk

1. Fill the carafe (C11) with a suitable quantity of fresh milk straight from the fridge. Bear in mind the milk will double or triple in volume (fig. 24). For a denser and more evenly distributed froth, best results will be achieved using whole cow's milk at refrigerator temperature (about 5 °C).

My LatteArt

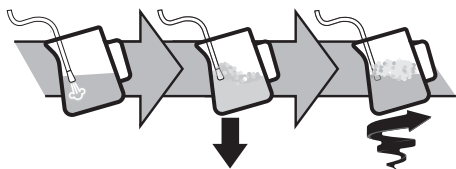

2. To froth the milk, bring the tip of the steam wand (A7) into contact with the surface of the liquid and turn the steam dial (A5): this causes air to mix with the milk and steam.
3. Keep the steam wand nozzle on the surface, taking care not to let in too much air and create unsuitably large bubbles.
4. Immerse the steam wand nozzle just beneath the surface of the milk: this will create a vortex in the liquid. Once the milk is heated to the desired temperature, turn off the steam and wait for the flow to stop completely before removing the milk carafe from the machine.

Barista tips:

- **Fresh milk is best.** Always use fresh milk straight from the fridge.
- For best results, always return the milk carafe to the fridge when not in use.
- Whole milk ensures optimum results. The appearance and texture of froth depend on the nature of the dairy milk or vegetable drinks used.

- After frothing the milk, get rid of unwanted bubbles by swirling the carafe gently.

Cleaning the steam wand:





1. Following use, always wipe the steam wand (fig. 25) with a cloth to remove residual deposits of milk. For a thorough cleaning, we recommend using Eco MultiClean: this product ensures maximum hygiene by removing milk proteins and fats, and can be used to clean the entire machine.
2. Release steam for a few seconds to clean the wand (fig. 9).
3. Wait until the steam wand has cooled down. To ensure the wand works efficiently over time, use the special cleaning tool (C12) to free the holes (fig. 26) of any obstruction.







6. PROGRAMMING DRINK QUANTITIES

1. Prepare the machine for brewing 1 or 2 cups of your desired beverage, by attaching the portafilter (C1) complete with the 1-cup or 2-cup filter and ground coffee.
2. Turn the dial (B8) to select the drink being programmed.
3. Press the 1-cup or 2-cup button “1x” (B2) or “2x” (B3) and hold for at least 3 seconds, until the indicator for the selected drink starts blinking to confirm that the machine is in programming mode. (To exit programming mode without making changes, press and hold the same button or wait for 30 seconds).
4. Press the OK button (B6). The OK indicator will now blink and the machine starts delivering the drink.
5. When the desired quantity has been reached, press the OK button again: the quantity is programmed.





Please note:





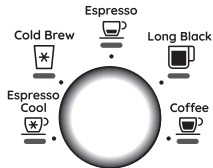



- Drinks can be programmed, but the delivery of steam and hot water can not.
- Programming changes the quantity of drinks delivered, but not of ground coffee.
- When a programmed drink is selected, the corresponding indicator blinks briefly.
- After 30 seconds of inactivity, the machine will automatically exit the programming mode.

Coffee recipe	Default quantity	Programmable quantity
Cold Brew 	≈ 110 ml	≈ 90 to ≈ 130 ml
Cold Brew  2x	≈ 180 ml	≈ 160 to ≈ 220 ml
Espresso 	≈ 35 ml	≈ 15 a ≈ 90 ml
Espresso  2x	≈ 70 ml	≈ 30 a ≈ 180 ml

Coffee recipe	Default quantity	Programmable quantity
Americano 	≈ 120 ml	<ul style="list-style-type: none"> • espresso: ≈15 to ≈90 ml • water: ≈25 to ≈120 ml
Americano  2x	≈ 240 ml	<ul style="list-style-type: none"> • espresso: ≈30 to ≈180 ml • water: ≈50 to ≈240 ml
Espresso Cool 	≈ 40 ml	≈ 30 to ≈ 50 ml
Espresso Cool  2x	≈ 80 ml	≈ 60 to ≈ 110 ml
Coffee 	≈ 80 ml	≈ 50 to ≈ 120 ml
Coffee  2x	≈ 160 ml	≈ 120 to ≈ 240 ml



7. SETTINGS MENU

1. Access the menu:		
Press together and hold for 5 seconds	1x	
2. Settings selected with dial (B7)		
		
Corresponding setting	Turn to	Adjustments
Extra grinding adjustment	Espresso 	 ⚙️ ➔ Range 1
		 ⚙️ ➔ Range 2
➔		

Water hardness	Americano 	 ⚙️ ➔ soft
		 ⚙️ ➔ medium
		 ⚙️ ➔ hard/very hard
Auto-off	Coffee 	 ⚙️ ➔ 5 minutes
		 ⚙️ ➔ 1.5 hours
		 ⚙️ ➔ 3 hours
Statistics	Espresso Cool 	Useful information for service (see heading "15. Statistics")
3. Press OK to save the new settings. (B4)		

Please note: After 30 seconds of inactivity, the machine will automatically exit the settings menu.

7.1 Restore factory settings

1. Access the menu:		
Press together and hold for 5 seconds	1x	
2. Reset to default values		
Hold down the  button until the OK light blinks	Press OK to resume normal use	

The OK indicator (B6) blinks briefly to confirm the reset has taken place.













8. CLEANING THE MACHINE

Important!

- Do not use solvents, abrasive detergents or alcohol to clean the machine.
- Do not use metal objects to remove encrustations or coffee deposits as they could scratch metal or plastic surfaces.
- If the appliance is not used for over a week, it is advisable to perform a rinse before preparing any drinks.

Danger!

- Never immerse the machine in water when cleaning: it is an electrical appliance.
- Before cleaning any external parts, ensure that the machine is switched off, unplug it from the mains socket and wait for it to cool down.

					
	✗	✓	✓	✗	✗
	✓	✗	✗	✓	✓
	✗	✗	✗	✓	✓
	✗	✗	✓	✗	✗
	✗	✗	✗	✓	✓
	✗	✗	✗	✓	✓
	✓	✗	✗	✓	✓

8.1 Cleaning the coffee grinder

1. Clean the attachment area with the brush (C9) (fig. 29).
2. Use the brush to clean the coffee funnel (fig. 30).

Efficient grinding

The burrs are subject to wear over time. This means that with continuous and regular use, the dial (B4) will need to be turned toward the higher numbers in order to obtain the perfect dose. Once a setting of between 30 and 40 has been reached, the extra grinding range becomes necessary (see section "7. Settings menu" - "Extra grinding adjustment").

When the quantity of ground coffee becomes less than expected, contact a service centre to have the burrs replaced. With the new burrs fitted, adjust the coffee grinder by accessing the settings menu and selecting the first range of the extra grinding adjustment. Now turn the quantity adjustment dial (B4) to the Min position and set the quantity as for first-time use (see "The "perfect dose"").

8.2 Cleaning the Espresso Cool filters

These filters have been designed to optimize the cold extraction process. Clean thoroughly and remove all traces of coffee to ensure their efficiency.

1. Following use, rinse the filters with plenty of water (fig. 29) and press the pierced filter element fully home (fig. 30). Should further cleaning be required, and in any event at least once a month, proceed as follows:

1. Remove the pierced filter element by pulling the tab (fig. 31).
2. Check that the hole on the underside of the filter (see fig. 32) is free of any residual matter.

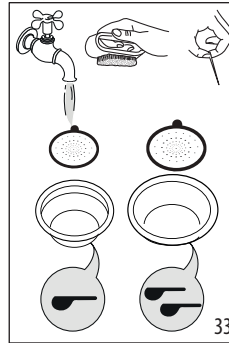

3. Rinse the filters under running water (fig. 33).
4. Make sure the holes are not blocked. Use a needle, if necessary.
5. Dry all the components with a cloth.
6. Insert the pierced filter element and press fully home (fig. 30).

8.3 Cleaning the "Smart tamping station"



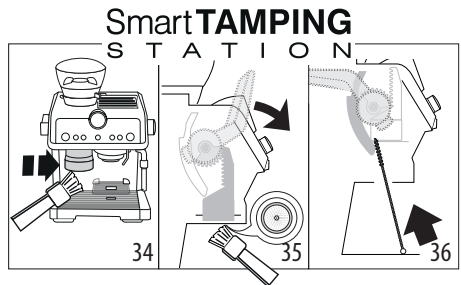

1. Clean the attachment area with a brush (fig. 34).
2. Pull the lever (A21) down completely and clean the tamper with a brush (fig. 35), then release the lever.
3. Use the tube brush (C7) to clean the coffee funnel (fig. 36).



9. WATER HARDNESS

The descale indicator  (B10) lights up following a predetermined period of operation that depends on a water hardness setting. The machine can also be programmed according to the actual hardness of the local water supply, in which case descaling may be required less frequently.

1. Remove the "TOTAL HARDNESS TEST" indicator strip (C6) from its pack.
2. Immerse the strip completely in a glass of water for about one second.
3. Remove the strip from the water and shake lightly.

Water Hardness Test Result	Button	Level
	× 2	1 soft water
		2 medium water
	OK	3 hard or very hard water
		

4. Set the machine accordingly, as indicated in the section "7. Settings menu" "Water hardness".

10. HOW TO USE SOFTBALLS

Softballs (C10) are an innovative treatment system able to prolong the life of the machine, without altering the properties of the water, while ensuring consistently creamy and aromatic coffee. To optimize the effectiveness of the treatment, leave Softballs in water overnight before use.

1. Take the Softballs sachet from the wrapper (fig. 37).

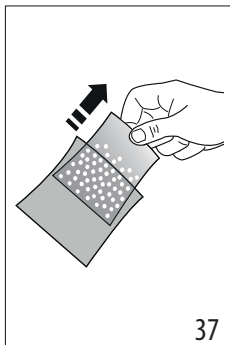

37

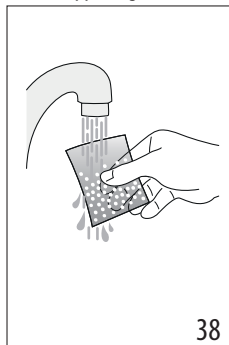

38

2. Rinse the sachet under running water (fig. 38).
3. Immerse the sachet in the machine's water tank (A15) (fig. 39).

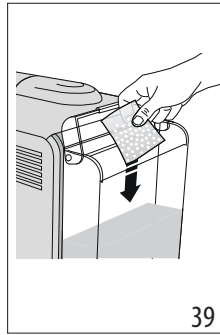

39



40



4. Replace the sachet of Softballs every 3 months (fig. 40).

11. DESCALING

Important!

- Regular descaling will ensure that optimum results are obtained over time: when a prompt is generated by the machine, purchase Ecodescalk on the delonghi.com website and proceed with descaling as indicated.
- Use only descaler supplied by De'Longhi. Using unsuitable descaler and/or performing descaling incorrectly may result in faults not covered by the manufacturer's guarantee.
- Before use, read the instructions and the labelling on the descaler pack.
- Descaler can cause damage to delicate surfaces. If the product is accidentally spilled, dry immediately.

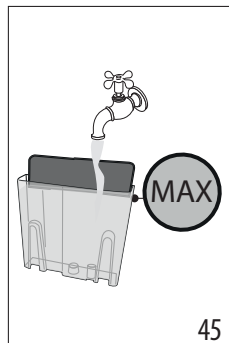
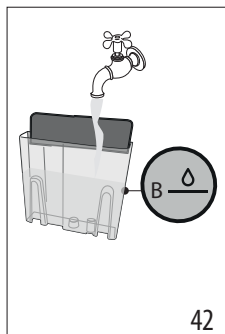
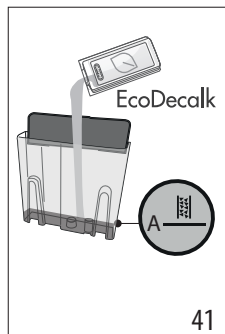

To descale	
Descaler	De'Longhi descaler
Container	Capacity 2 litres
Time	~20min

1. When the  indicator (B10) lights up, this means that descaling is required. A descale cycle can be run at any time.
2. Pull out and empty the drip tray (A11), then insert it back in the machine.
3. (REMOVE WATER SOFTENER AND SOFTBALLS, IF PRESENT). Pour the descaler into the water tank (A15) up to the first level  A marked on the inside of the tank (which corresponds to the contents of one 100ml pack) (fig. 41).

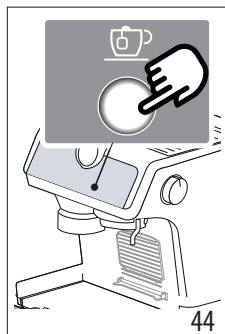
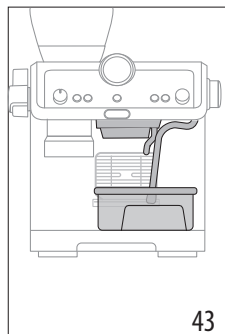

4. Add water up to level  B (fig. 42). Now reposition the water tank in the machine.



5. Make sure that the portafilter (C1) is not attached. Position a container under the coffee spout and the hot water spout, and another under the steam wand (A7) (fig. 43).
6. Press the  button (B6) and hold until the  indicator (B10) starts to blink.
7. Press the OK button: the corresponding indicator will blink.
8. The descaling programme starts and the descaler comes out of the spouts. The descale programme removes limescale deposits from the inside of the machine by automatically performing a series of rinses and pauses until the tank is empty. Descaling ceases and the OK indicator turns blue. This means that a rinse cycle must be carried out:
9. Empty the container used to collect the descaler solution and reposition it under the spouts.
10. Remove the water tank, empty out any residual descaler solution, rinse under running water and fill with fresh water up to the MAX level (fig. 45). Return the tank to the machine.



11. Press the OK button. The rinse cycle starts.
12. Once the rinse cycle has been completed, water will stop draining out and the machine is ready for use.
13. Empty the containers used to collect the rinse water.
14. Pull out and empty the drip tray, then reinsert it.
15. Remove the tank, fill with cold water and return it to the machine.
16. The OK indicator turns white. The machine is now ready for use.

Please note:

- The descaling cycle can be started up at any time (even if the relative indicator is not yet on).
- Should descaling be started up by mistake, it can be stopped by pressing the  button and holding for 10 seconds; the rinse cycle cannot be stopped.
- After 30 seconds without a button being pressed, the machine exits the descaling programme automatically.

12. CLEANING THE COFFEE SPOUT (A19)

When the  indicator lights up (orange) (B11), it means that the coffee circuit needs to be cleaned. Use De'Longhi cleaning tabs (C9) to carry out the cleaning cycle. For more information, visit www.delonghi.com.









1. Insert the 1-cup filter (C2) in the holder (C1) (fig. 26).
2. Position the cleaning accessory in the filter (C8) (fig. 27) and press home.
3. Place the cleaning tab on the accessory (fig. 28).
4. Attach the portafilter to the coffee spout (A19).
5. Fill the tank(A15) with water. Make sure the drip tray (A11) is empty.
6. Press the  button (B5) and hold until the  indicator (B11) starts to blink.
7. Press OK (B4) to start cleaning: the OK indicator blinks to indicate that cleaning is in progress.
8. When delivery stops and the OK indicator turns blue, it is time to run a rinse cycle.













9. Remove the cleaning accessory, and wash the portafilter and the filter under running water.
10. Attach the portafilter again and run a rinse cycle by pressing the OK button: it is advisable to place a container under the portafilter.
11. Once the rinse has been completed, the machine is ready for use.
12. Remove and empty the drip tray.











Please note:

- The cleaning cycle can be started up at any time (even if the relative indicator is not yet on).
- Should the cleaning cycle be started by mistake, press the  button and hold for 10 seconds; the rinse cannot be stopped.
- After 30 seconds without a button being pressed, the machine exits the cleaning cycle automatically.



13. EXPLANATION OF INDICATORS

INDICATORS	EXPLANATION OF INDICATORS	OPERATION
All lights blink briefly	Turning the machine on	Self-diagnosis
 permanently alight	The machine has been turned on for the first time and the water circuit must be filled	Proceed as indicated in section [manca tag] "3. Setting up the machine"
 permanently alight (white) <ul style="list-style-type: none"> • 1x - 2x indicators: the number of cups must be selected •  light: indicates the selected coffee temperature •  indicator: indicates the machine is ready to deliver hot water • Hot drink indicator: indicates the drink selected 	The machine is ready to deliver hot drinks	Set up the machine and proceed with preparation of the drink
 permanently alight (blue) <ul style="list-style-type: none"> • 1x - 2x indicators: the number of cups must be selected •  indicator: indicates the machine is ready to deliver hot water • Cold drink indicator: indicates the drink selected 	The machine is ready to deliver cold drinks	Set up the machine and proceed with preparation of the drink
 permanently alight	The beans hopper(A2) is empty	Fill the beans hopper
 blinking	The grinding function has been selected, but the beans hopper(A2) is empty	Fill the beans hopper
 permanently alight	There is not enough water in the tank (A15) or the tank is not correctly in place	Fill the tank with water, or remove the tank and reposition it correctly
		→

INDICATORS	EXPLANATION OF INDICATORS	OPERATION
 blinking	An attempt is being made to prepare a drink, but the water tank (A15) is empty	Fill the tank with water
	The grinding is too fine, so that the coffee is delivered too slowly or not at all.	Remove the portafilter (C1) and repeat the coffee-making steps, bearing in the mind the indications given in sections “4. Making coffee” and “4.2 Step 2 - Tamping”
	The coffee filter is clogged	Rinse the filters under running water
	The tank (A15) is not properly in place and the relative valves are not open	Press down lightly on the tank to open the valves
	Limescale in the water circuit	Descale as described in section “11. Descaling”
 permanently alight (red)	General alarm	Contact Customer Services
 permanently alight (orange)	The coffee spout requires cleaning	See section “12. Cleaning the coffee spout (A19)”
 blinking (orange) +  permanently alight (white)	The machine is ready for cleaning the coffee spout	
 blinking (orange) +  blinking (white)	Coffee spout cleaning is in progress	
 blinking (orange) +  permanently alight (blue)	The coffee spout needs to be rinsed	
 blinking (orange) +  blinking (blue)	Coffee spout rinsing is in progress	
 permanently alight	The machine is ready to deliver steam	The machine is at the right temperature to deliver steam Turn the steam dial to start delivering steam from the wand
 blinking	The machine is switched on with energy saving active. The steam dial (A5) is in the delivery position	The indicator blinks to signal that the machine is preparing to deliver steam. Delivery begins when the steam circuit is up to the right temperature
	The machine is ready to deliver steam	The machine is at the right temperature when the indicator remains permanently alight
	The machine is delivering steam	
→		

INDICATORS	EXPLANATION OF INDICATORS	OPERATION
 blinking	The funnel of the coffee grinder is clogged	<p>Clean as described in section “8.3 Cleaning the “Smart tamping station””. If the problem persists, access the funnel by opening the flap (A22) and clear the blockage using the tube brush (C7)</p> <p>Check that the coffee filter being used matches the number of cups selected</p> <p>Reduce the coffee dosage by turning the dial (B1)</p>
 permanently alight + x1 and x2 blinking	The lever (A21) is not correctly positioned	After tamping, return the lever to the at-rest position.
 permanently alight (red)	Descaling is required	Carry out descaling as described in section [manca tag]“11. Descaling”
 blinking (red) +  permanently alight (white)	The machine is ready to carry out descaling	
 blinking (red) +  blinking (white)	The machine is currently descaling	Complete the operations described in section “11. Descaling”
 blinking (red) +  permanently alight (blue)	Rinsing is required	
 blinking (red) +  blinking (blue)	Rinsing is in progress following completion of the descale cycle	

14. TROUBLESHOOTING

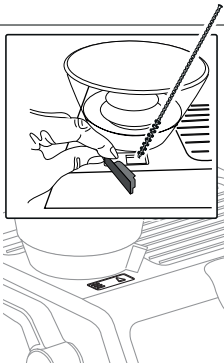

PROBLEM	CAUSE	SOLUTION
There is water in the drip tray (A11)	This water comes from the internal circuits of the machine and is a normal consequence of their operation	Empty and clean the drip tray on a regular basis
The machine fails to produce espresso coffee	No water in the tank (A15)	Fill the tank
	The  (B6) light is on, meaning that the coffee circuit or the steam circuit is empty	Press the button associated with the  light to fill the circuit
	The coffee filter is clogged	Rinse the filters under running water. For dedicated Espresso Cool filters, see [manca tag] "8.2 Cleaning the Espresso Cool filters"
	The tank (A15) is not properly in place and the valves at the bottom are not open	Press down lightly on the tank to open the valves at the bottom
	Limescale in the water circuit	Descale as described in section "11. Descaling"
	Coffee ground too finely	Remove the portafilter (C1) and repeat the coffee-making steps, bearing in the mind the indications given in sections "4. Making coffee" and "4.2 Step 2 - Tamping"
The portafilter cannot be attached to the machine	The ground coffee has not been tamped or the quantity is excessive	Repeat the grinding step with different settings. Reduce the dosage quantity: check that the filter (1 or 2 cups) and the grinding dosage are correctly matched (1x button (B2) or 2x button (B3) selected)
The espresso coffee drips from the edges of the portafilter (C1) instead of from the spouts	The portafilter is not properly attached	Attach the portafilter correctly and twist firmly as far as it will go
	The seal of the coffee spout (A19) has lost flexibility or is dirty	Have the coffee spout seal replaced by a Service Centre
	The coffee filter is clogged	Rinse the filters under running water. For dedicated Espresso Cool filters, see [manca tag] "8.2 Cleaning the Espresso Cool filters"
The espresso cream is too light (delivered from the spout too fast)	The appliance settings need reviewing	Remove the portafilter and repeat the coffee-making steps, bearing in the mind the indications given in sections "4. Making coffee" and "4.2 Step 2 - Tamping"
		→



PROBLEM	CAUSE	SOLUTION
The espresso cream is too dark (delivered from the spout too slowly)	The appliance settings need reviewing	Remove the portafilter (C1) and repeat the coffee-making steps, bearing in the mind the indications given in sections “4. Making coffee” and “4.2 Step 2 - Tamping”
On completion of the descale cycle, the machine calls for a further rinse	During the rinse cycle, the water tank has not been filled to the MAX level	Repeat the rinse cycle (see section “11. Descaling”)
The machine does not grind the coffee	Foreign matter has found its way into the coffee grinder	Turn the selector to 15 and remove all beans with a vacuum cleaner, completely emptying and cleaning out the beans hopper(A2). If the problem persists, contact customer services
Changing to a different type of coffee		<ul style="list-style-type: none"> • It is advisable to fill the beans hopper(A2) only with the quantity of beans effectively needed • To empty the container, remove the contents using a vacuum cleaner, or grind all the beans left in the container until completely empty • Introduce the new beans • If the amount of ground coffee does not give the perfect dose, proceed to set up the machine as for first-time use
<p>After grinding, the coffee filter is empty</p> <p>After grinding, there is too much coffee in the filter</p>	The funnel of the coffee grinder is clogged	<p>Clean as described in section “8.3 Cleaning the “Smart tamping station””. If the problem persists, access the funnel by opening up the relative flap (A22) and clear the blockage using the tube brush</p> 
		→



PROBLEM	CAUSE	SOLUTION
After grinding, the amount of coffee in the filter does not give the “perfect dose”	The "Smart Tamping Station" needs cleaning	Carry out cleaning as described in section “8.3 Cleaning the “Smart tamping station””, then repeat the grinding step
	The quantity of ground coffee needs adjusting	Adjust the quantity with the relative dial (B1) following the indications given in section “The “perfect dose””. If the dial is already in the MAX position, proceed as described in section “7. Settings menu” - “Extra grinding adjustment”
	The 2-cup filter is being used	Make sure the 2x indicator is on
	Over time the burrs wear down	Contact Customer Services
There is ground coffee on the cup tray after using the grinder	During the pressing operation the tamping step, the lever was not returned to the at-rest position.	To tamp the coffee correctly: <ul style="list-style-type: none"> • Bring the lever fully down; • Return the lever to the at-rest position; • Repeat the tamping stroke, and when the lever is fully down, remove the portafilter so that the compacted coffee remains smooth and glossy; • Return the lever to the at-rest position.































15. STATISTICS

Machine statistics are useful in the event of service being needed. Proceed as follows:

- Access the menu by pressing buttons 1x (B2) and  (B6) simultaneously and holding for 3 seconds;
- Turn the dial (B7) to select  “Espresso Cool”;
- Press  (B5);
- Once you have entered the settings menu, select the desired data by rotating the selection dial as shown in the following table:

Positioning of dial	Counter
Cold Brew 	Total count of descale cycles
Espresso 	Total count of hot drinks
Espresso Cool 	Total count of cold drinks

- The 1x, 2x, OK,  and  indicators show the numbers of operations:

Control panel indicators	Drinks count	Descale count
    	up to 100	up to 1
    	between 100 and 1000	between 2 and 10
    	between 1000 and 3000	between 10 and 30
    	between 3000 and 6000	between 30 and 60
    	between 6000 and 11000	between 60 and 110
    	more than 11000	more than 110

- The appliance automatically exits the settings menu after 30 seconds of inactivity.

16. TECHNICAL DATA

Voltage:	220-240 V~ 50-60 Hz
Power:	1550 W
Pressure:	1.9 MPa (19 bar)
Water tank capacity:	2l
Dimensions LxDxH:	369x380x445 mm
Weight:	13.2 kg
Beans container capacity:	250 g

De'Longhi reserves the right to modify the technical specification and styling of its products at any moment, without compromising their functionality and quality.

Prima di utilizzare l'apparecchio leggere sempre il fascicolo delle avvertenze di sicurezza.

1. DESCRIZIONE

1.1 Descrizione dell'apparecchio - A

- A1. Coperchio contenitore chicchi
- A2. Contenitore chicchi
- A3. Selettore grado di macinatura (da fine a grossa)
- A4. Poggiatazze
- A5. Manopola vapore
- A6. Erogatore acqua calda
- A7. Lancia vapore
- A8. Griglia poggiatezze per espresso
- A9. Griglia poggiatezze per bicchieri o mug
- A10. Griglia vaschetta
- A11. Vaschetta raccogliogocce
- A12. Indicatore di livello acqua nella vaschetta raccogliogocce
- A13. Coperchio serbatoio acqua
- A14. Maniglia estrazione serbatoio acqua
- A15. Serbatoio acqua
- A16. Sede filtro addolcitore
- A17. Cavo alimentazione
- A18. Interruttore generale (ON/OFF)
- A19. Erogatore caffè
- A20. Uscita macinacaffè (Tamping station)
- A21. Leva pressino
- A22. Sportellino per accedere allo scivolo del macinacaffè

1.2 Descrizione pannello di controllo - B

- B1. Manopola regolazione quantità caffè macinato
- B2. Tasto "X1": per utilizzare il filtro 1 caffè
- B3. Tasto "X2": per utilizzare il filtro 2 caffè
- B4. Tasto "OK": per erogare la bevanda/per confermare/per accendere la macchina dopo lo standby
 - colore bianco: erogazione bevande calde
 - colore blu: erogazione bevande fredde
- B5. Tasto "temperatura caffè"
- B6. Tasto "erogazione acqua calda"
- B7. Manopola selezione bevande:
 - Espresso Cool
 - Cold Brew
 - Espresso
 - Americano
 - Coffee
- B8. Spia "erogazione vapore"
- B9. Spia "mancanza acqua"
- B10. Spia "decalcificazione"
- B11. Colore arancio: pulizia erogatore caffè
 - colore rosso: allarme generico
- B12. Spia "contenitore chicchi"
- B13. Spia "anti intasamento"
- B14. Manometro

1.3 Descrizione degli accessori - C

- C1. Coppetta portafiltra
- C2. Filtro 1 tazza
- C3. Filtro 2 tazze

Filtri dedicati per **Espresso Cool**  :

- C4. Filtro 1 tazza
- C5. Filtro 2 tazze
- C6. Striscia reattiva "Total Hardness Test"
- C7. Scovolino
- C8. Accessorio pulizia erogatore caffè
- C9. Cleaning tabs: pastiglie per la pulizia dell'erogatore caffè
- C10. Softballs
- C11. Bricco latte
- C12. Ago di pulizia per lancia vapore

1.4 Accessori pulizia non inclusi, raccomandati dal costruttore

Per maggiori informazioni, vai su www.delonghi.com.

ECO MULTICLEAN  **Detergente**
EAN: 800439933307

ECODECALK  **Decalcificante**

2. PREPARAZIONE DELL'APPARECCHIO

Lavare con acqua tiepida e detersivo per piatti tutti gli accessori, quindi procedere come segue:

1. Inserire il vassoio raccogliogocce (A11) completo di griglia poggiatezze (A9) e griglia vaschetta (A10) (fig. 1);
2. Estrarre il serbatoio acqua (A15) (fig. 2) e riempirlo con acqua fresca e pulita facendo attenzione a non superare la scritta MAX (fig. 3).
3. Quindi reinserire il serbatoio.

Attenzione: Non mettere mai in funzione l'apparecchio senza l'acqua nel serbatoio o senza serbatoio.

Nota bene: Si consiglia di personalizzare al più presto la durezza dell'acqua seguendo la procedura descritta nel capitolo "7. Menù impostazioni".

3. PRIMA MESSA IN FUNZIONE DELL'APPARECCHIO

1. Inserire la spina nella presa. Premere l'interruttore generale (A18) (fig. 4).
2. Posizionare sotto l'erogatore acqua calda (in corrispondenza dell'erogatore caffè (A19)) un contenitore con capienza minima di 100 ml (fig. 5);
3. Premere il tasto  in corrispondenza della spia (fig. 6): l'erogazione inizia e si interrompe automaticamente. Svuotare il contenitore.

Register Now

www.delonghi.com/register



De'Longhi Appliances via Seitz, 47 31100 Treviso Italia delonghi.com

57132C8916_01_1223