









Ford Sec. 18



>Ub. 20&\$

Ford





Nuts Barrel

709PK	1/8" Stud Size 3/16" Hole Size Black Finish Barrel Nuts Ford # 375890-S100	100 Pcs.		
710PK	1/8" Stud Size 1/4" Hole Size Black Finish Barrel Nuts Ford # 375480-S100, 3783794	100 Pcs.		
9878PK	3/16" Stud Size 17/64" Hole Size Black Nylon Barrel Nuts Ford # D7VY-6050074-A Renault # 8934-201-767	100 Pcs.		
9941PK	1/4" Stud Size 9/32" Hole Size Black Finish Barrel Nuts Ford # 354341-S	100 Pcs.		





Nuts Push On Type Threaded Stud Metric

1621PK	6-1.00mm Screw Size 17mm Outside Diameter Flange Zinc Plated Push On Type Retainers Chrysler # 6501178, 6501192 Ford # N801192S36 G.M. # 11503736, 11609738, 14093869	100 Pcs.	
---------------	---	-----------------	---

Nuts Hex Loose Washer Metric



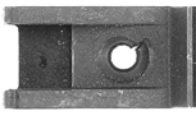





1639PK	5-.80mm Screw Size 10mm Hex Size 15mm Outside Diameter Loose Washer Black Finish Metric Hex Nuts AMC # 4200408 Ford # N621903-S61, N621903-S2 G.M. # 11504614	50 Pcs.		
5916XP	8-1.25mm Screw Size 13mm Hex Size 24mm Outside Diameter Loose Barbed Washer Black Finish Metric Hex Nuts Ford # N621940-S424 G.M. # 11503695, 11506117, 11516780, 11500401	25 Pcs.		

Nuts Speed Type "U" for Sheet Metal Screws









1350PK	#8 (4.20mm) Screw Size 3/8" Center of Hole to Edge .020 - .150" Panel Range Black Finish Speed Type "U" Nuts Ford # 381818-S2, 15650655 G.M. # 9424837, 9431530, 15650655	100 Pcs.		
5750PK	#8 (4.20mm) Screw Size 5/8" Center of Hole to Edge .025 - .150" Panel Range Black Finish Speed Type "U" Nuts Ford # 381863-S2 G.M. # 9440178, 9433155, 11504531	100 Pcs.		

Ford

Nuts Extruded Type "U" Standard









2969PK	1/4 - 20 Screw Size 17/32" Center of Hole to Edge .010 - .165" Panel Range Black Finish Extruded "U" Nuts Ford # 45263-S2 G.M. # 1494252, 1480627	25 Pcs.		
5480PK	1/4 - 20 Screw Size 25/32" Center of Hole to Edge .010 - .165" Panel Range Black Finish Extruded "U" Nuts Ford # 45267 G.M. # 1494257	25 Pcs.		
1836PK	5/16 - 18 Screw Size 27/32" Center of Hole to Edge .010 - .170" Panel Range Black Finish Extruded "U" Nuts Ford # 379831-S G.M. # 1494258	25 Pcs.		
5412PK	3/8 - 16 Screw Size 3/4" Center of Hole to Edge .035 - .205" Panel Range Black Finish Extruded "U" Nuts Ford # 45265-S2 G.M. # 1494254, 12337873	25 Pcs.		
5466PK	3/8 - 16 Screw Size 1 1/8" Center of Hole to Edge .035 - .220" Panel Range Black Finish Extruded "U" Nuts Ford # 45269, 45269-S	25 Pcs.		

Nuts Extruded Type "U" Metric











10795PK	#8 (4.20-1.41mm) Screw Size 9.50mm Center of Hole to Edge .65mm-3.80mm Panel Range Zinc Organic Prevailing Torque Extruded "U" Nuts G.M. # 11513599 Ford # W704823-S439	25 Pcs.		
12893PK	5-.80mm Screw Size 11mm Center of Hole to Edge .60mm-3.80mm Panel Range Black Finish Extruded "U" Nuts Ford # N623331-S2, W520821-S439, W520821-S426 G.M. # 11505596, 11500656	50 Pcs.		
10836PK	6-1.00mm Screw Size 13.50mm Center of Hole to Edge .80mm-4mm Panel Range Black Phosphate Organic Finish Prevailing Torque Extruded "U" Nuts Chrysler # 6101308 Ford # N800854-S1 G.M. # 11509005	25 Pcs.		
5596PK	6-1.00mm Screw Size 13.50mm Center of Hole to Edge .80mm-4mm Panel Range Black Finish Extruded "U" Nuts Ford # N623332, N623332-S2, N623332-S53, N623332-S100 G.M. # 11503957, 11503716, 1016937	25 Pcs.		

Ford

Nuts Extruded Type "U" Metric













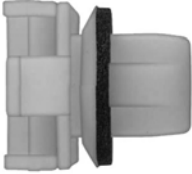

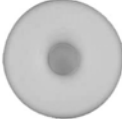

9512PK	6-1.00mm Screw Size 13.50mm Center of Hole to Edge 3.40mm-6.30mm Panel Range Black Finish Extruded "U" Nuts Ford # N802331-S53 G.M. # 11504047	25 Pcs.		
5650PK	6-1.00mm Screw Size 19.50mm Center of Hole to Edge 1.00mm-2.50mm Panel Range Black Finish Extruded "U" Nuts Ford # W520832-S424, W520832-S426 G.M. # 11503715, 11506099, 11508241	25 Pcs.		
5560PK	8-1.25mm Screw Size 14.50mm Center of Hole to Edge .80mm-4mm Panel Range Black Finish Extruded "U" Nuts Chrysler # 6100042, 6101283 Ford # N623333-S2, N623333-S100 G.M. # 11500660, 11508925, 11502617	25 Pcs.		
5557PK	8-1.25mm Screw Size 20mm Center of Hole to Edge .80mm-4.50mm Panel Range Black Finish Extruded "U" Nuts Ford # N623343-S100 G.M. # 11500661, 11503317, 11516150	25 Pcs.		

Nuts Nylon

1227PK	#6 (3.50mm) Screw Size 8.50mm Stem Length 9 x 13mm Head Size 6.50 x 9mm Hole Size Black Nylon Front Fender Screw Grommets Ford # N-800503S	50 Pcs.		
10715PK	#6 (3.50mm) Screw Size 16mm Stem Length 22 x 23.50mm Head Size 15mm Hole Size Black Nylon Headlight Screw Grommets Ford # W712160-S300	15 Pcs.		
1842PK	#8 (4.20mm) Screw Size 13/32" Stem Length 3/8" Head Size 1/4" Hole Size Natural Nylon Grille Screw Grommets Ford # 379830-S	50 Pcs.		
12021PK	#8 (4.20mm) Screw Size 13/32" Stem Length 3/8" Head Size Black Nylon Screw Grommets Chrysler # 6033677 Ford # 379830-S, 383356-S	25 Pcs.		
10556PK	#8 (4.20mm) Screw Size 11mm Stem Length 10mm Head Size 6.70mm Hole Size Natural Nylon Door Reveal Screw Grommets Ford # W710362 G.M. # 25647358	25 Pcs.		













Ford

Nuts Nylon







10497PK	#8 (4.20mm) Screw Size 12mm Stem Length 9.50mm Head Size 5.50mm Hole Size Natural Nylon Rear Bumper Screw Grommets Ford # W711412-S300	50 Pcs.		
10384PK	#8 (4.20mm) Screw Size 13mm Stem Length 23.20mm Square Head Size 10 x 14mm Hole Size White Nylon Cowl Vent Grommets Ford # N807189-S100, N811353-S100	10 Pcs.		
11994PK	#8 (4.20mm) Screw Size 18mm Stem Length 11.50mm Head Size Black Nylon Tail Light & Bumper Screw Grommets Ford # W708580-S300	25 Pcs.		
10552PK	#8 (4.20mm) Screw Size 18mm Stem Length 13 x 22mm Head Diameter 6 x 16.50mm Hole Size Natural Nylon With Sealer Back Glass Moulding & Interior Trim Ford # W705590-S300, 713459-S300 G.M. # 25649667	15 Pcs.		
2117PK	#8 (4.20mm) Screw Size 23mm Stem Length 10mm Head Size 7mm Hole Size Natural Nylon Screw Grommets Ford # N804765-S	50 Pcs.		
11229PK	#10 (4.80mm) Screw Size 24mm Stem Length 16mm Head Diameter 10mm Hole Size White Nylon With Sealer Front Bumper Screw Grommets Ford # W708319-S300	25 Pcs.		
17908PK	#10 (4.80mm) Screw Size 11mm Stem Length 20mm Head Diameter 11.50 x 7.50mm Hole Size Red Nylon Radiator Grille Screw Grommets Ford # W702438-S300	25 Pcs.		
15839PK	#12 (5.50mm) Screw Size 15mm Stem Length 16mm Head Diameter 10mm Hole Size Natural Nylon Back Panel Attachment Grommets Ford # W700566-S300	25 Pcs.		
9136PK	#12 (5.50mm) Screw Size 3/8" Square Hole 13/16" Stem Length 1/2" Head Size Natural Nylon Windshield Washer Reservoir Mounting Screw Grommets Ford # F5RZ-17K657-A	25 Pcs.		

Ford

Nuts Nylon

















9494PK	#14 (6.40mm) Screw Size 5/16" Stem Length 5/8" x 3/4" Head Size 3/8" Hole Size Natural Nylon License Plate Nuts Ford # 380707-S	50 Pcs.		
10461PK	#14 (6.40mm) Screw Size 8mm Stem Length 16mm Head Size 9.50 x 10mm Hole Size Black Nylon With Sealer License Plate Nuts Ford # N811478-S100	15 Pcs.		
9355PK	13mm Head Diameter 9mm Stem Length 10mm Hole Size Black Nylon Grille & Side Marker Light Screw Grommets Ford # N807994-S, N811169S, W704740-S300, W705550S300	50 Pcs.		
9712PK	13mm Head Diameter 9mm Stem Length 11mm Hole Size White Nylon Park & Turn Signal Grommets Ford # N811169-S, W705550-S300 G.M. #10423331 Toyota # 90075-10801, 90189-06111	50 Pcs.		
12024PK	13 x 17mm Head Size 10mm Stem Length 10 x 11mm Hole Size Black Nylon Tail Light Grommets Ford # W711079-S300	25 Pcs.		
11126PK	18.50 x 21.50mm Head Size 18mm Stem Length 9.50 x 21.50mm Hole Size Black Nylon Headlight & Tail Light Grommets Ford # F50Y-14603-A	25 Pcs.		

Grommets



17832PK	9/32" (7mm) Hole Size 25mm Stem Length 21mm Head Diameter Black Nylon Rear Bumper Cover Retainers Use With # 18145PK Ford # W708035-S3000	25 Pcs.		
18145PK	3/8" (9.50mm) Hole Size 21mm Stem Length Natural Rubber Rear Bumper Cover Grommets Use With # 17832PK	25 Pcs.		
18255PK	3/8" (9.50mm) Hole Size 21mm Stem Length Black Rubber Rear Bumper Cover Grommets Use With # 17832PK Ford # W708045-S300	25 Pcs.		

Ford

Nuts Miscellaneous Metric



12273PK	#6 (3.50mm) Screw Size 10mm Width 18mm Height Zinc Finish Bumper & Grille Fasteners Chrysler # 4806226-AA, 68004187-AA Ford # W710754-S439 G.M. # 11562364	15 Pcs.		
10733PK	#8 (4.20mm) Screw Size .70mm-1.50mm Panel Range 8.70mm Hole Size Gray Finish With Sealer Tail Light Quarter Panel Nuts Ford # W714171-S439 G.M. # 11569711	25 Pcs.		
11034PK	#8 (4.20mm) Screw Size 9 x 11mm Hole Size Black Finish Dash Panel Nuts Ford # N803685S G.M. # 14083173, 17997722, 17988488	25 Pcs.		
11032PK	#8 (4.20mm) Screw Size .70mm-2.30mm Panel Range 8.70mm Hole Size Blue Finish Mid Panel Nuts Chrysler # 6509432AA Ford # W716529-S900 G.M. # 1570654	25 Pcs.		
9199PK	#8 (4.20mm) Screw Size Zinc Finish Radiator Grille Nuts Ford # N802865-S100 G.M. # 15686142, 11561448	25 Pcs.		
18096PK	#8 (4.20mm) Screw Size 11.70mm Width 16.50mm Length Gray Finish With Sealer Specialty Nuts Ford # W713617-S439	15 Pcs.		
11228PK	15mm Width 17mm Overall Height Black Finish Front Bumper Retainers Ford # W705990-S305	25 Pcs.		
11862PK	15.50mm Width 23.10mm Length Stainless Steel Bumper Cover Retainers Ford # F32Z-17C756-S, Mazda # GJ21-50-049	50 Pcs.		



Nutserts Hex Type Automotive

12444PK	6-1.00mm Thread Size 8mm Hex Size 12mm Flange Diameter .65mm-2mm Grip Range Zinc Finish With Sealer Hex Type Steel Nutserts Ford # N803763-S100 G.M. # 15685099, 11518684	15 Pcs.		
----------------	--	----------------	---	---



Ford



Nutserts Hex Type Automotive

12443PK	6-1.00mm Thread Size 9.50mm Hex Size 13mm Flange Diameter .50mm-4.20mm Grip Range Yellow Zinc With Sealer Hex Type Steel Nutserts Ford # W706172-S309, W708384-S309	15 Pcs.		
----------------	---	----------------	--	---



11406PK	8-1.25mm Thread Size 12.70mm Hex Size 22mm Flange Diameter .70mm-3.80mm Grip Range Zinc Finish Hex Type Steel Nutserts Ford # W708513-S437	15 Pcs.		
----------------	--	----------------	--	---



Rubber Products



10047PK	1/4" (6.35mm) Hole Size 7/16" Stem Length 1/4 x 3/8" Head Size Black Rubber Gas Tank Bumper Ford # 357811	25 Pcs.		
----------------	--	----------------	--	---



10449PK	9/32" (7.14mm) Hole Size 19/32" Stem Length 15/32" Head Diameter Black Rubber General Purpose Bumpers Ford # 16758A	25 Pcs.		
----------------	--	----------------	--	---



Retainers Shield

8172PK	3/16" (4.50mm) Hole Size 21/32" Stem Length 7/16" Head Diameter .060 - .390" Panel Range Black Nylon Dash Panel Retainers Ford # 388246A AMC # 4006516 G.M. # 25016383, 20413107	50 Pcs.		
---------------	---	----------------	--	---

9178PK	13/64" (5mm) Hole Size 1/2" Stem Length 7/16" Head Diameter Black Nylon Fascia Shield Retainers Ford # N803170-S	25 Pcs.		
---------------	---	----------------	--	---















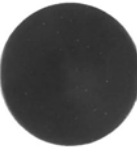

JL-26PK	13/64" (5.20mm) Hole Size 11/16" Stem Length 3/4" Head Diameter .065 - .515" Panel Range Blue Nylon Shield Retainers Ford # N8010994S	50 Pcs.		
----------------	---	----------------	--	---

5614PK	7/32" (5.60mm) Hole Size 25/32" Stem Length 1" Head Diameter .080 - .545" Panel Range Black Nylon Shield Retainers Ford # N808370-S	50 Pcs.		
---------------	---	----------------	--	---

11002PK	15/64" (6mm) Hole Size 20mm Stem Length 18mm Head Diameter Black Nylon Bumper & Fender Apron Retainers Ford # W711687-S300 G.M. # 11589181	25 Pcs.		
----------------	--	----------------	--	---

















Ford

Retainers Shield

10568PK	15/64" (6mm) Hole Size 33mm Stem Length 18mm Head Diameter Black Nylon Wheel Well Shield Retainers Ford # W709002, W709002-SAA G.M. # 11588950	25 Pcs.		
10400PK	1/4" (6.30mm) Hole Size 8.70mm Stem Length 14mm Head Diameter Black Nylon Front End Fascia Retainers Ford # N803857S	50 Pcs.		
1410PK	1/4" (6.30mm) Hole Size 1/2" Stem Length 3/4" Head Diameter Black Nylon Mud Shield Retainers Chrysler # 3861577 Ford # 387258-S G.M. # 20032850	100 Pcs.		
5429PK	1/4" (6.30mm) Hole Size 21/32" Stem Length 11/16" Head Diameter .115 - .400" Panel Range Black Nylon Bumper & Fender Shield Retainers Chrysler # 6031321, 3691590 Ford # 389358-S G.M. # 332364, 14093311, 20732399 AMC # 4004569	100 Pcs.		
5625PK	1/4" (6.30mm) Hole Size 13/16" Stem Length 23/32" Head Diameter .095 - .540" Panel Range Black Nylon Fender & Bumper Shield Retainers AMC # 4004919 Chrysler # 6036007AA, 6502078, 6030441 Ford # 388577S, 389358S, W705589-S300 G.M. # 1605396, 11569768, 15958694	100 Pcs.		
9446PK	1/4" (6.30mm) Hole Size 15/16" Stem Length 1/2" Head Diameter Black Nylon Engine Mount Heat Retainers Ford # N804448	25 Pcs.		
5627PK	1/4" (6.30mm) Hole Size 1 3/32" Stem Length 1" Head Diameter .100 - .685" Panel Range Black Nylon Trim Panel Retainers Ford # 388930-S, 391039-S	50 Pcs.		
9130PK	1/4" (6.30mm) Hole Size 1 1/16" Stem Length 23/32" Head Diameter .095 - .805" Panel Range Black Nylon Engine Splash Shield Retainers Chrysler # 6033082, 6033840 Ford # W709346-S300, 39001S G.M. # 10121502, 10077401	50 Pcs.		

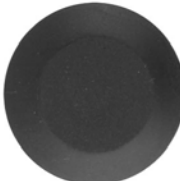









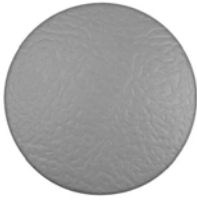

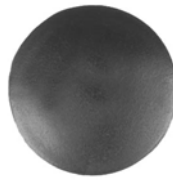

Ford

Retainers Shield

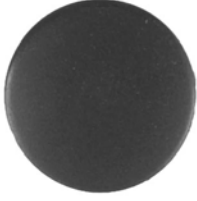
11250PK	1/4" (6.30mm) Hole Size 28mm Stem Length 26mm Head Diameter Black Nylon Fender Liner Retainers Ford # W706635-SSW	50 Pcs.		
9510PK	1/4" (6.30mm) Hole Size 1 1/8" Stem Length 1" Head Diameter Black Nylon Cowl Side Trim Shield Retainers Ford # E9SB-6302354-ACW	25 Pcs.		
10434PK	1/4" (6.30mm) Hole Size 35mm Stem Length 18mm Head Diameter 10.50mm-26.60mm Panel Range Charcoal Gray Nylon Wheel Opening Moulding Retainers Ford # W705955-S300 G.M. # 10146315	50 Pcs.		
10975PK	1/4" (6.30mm) Hole Size 35mm Stem Length 22mm Head Diameter Black Nylon Fender Liner & Mud Flap Retainers Ford # W701855-S300	25 Pcs.		
10064PK	1/4" (6.30mm) Hole Size 45mm Stem Length 18mm Head Diameter 3.20mm-40mm Panel Range Black Nylon Mud Flap Retainers Ford # W707889-S300	25 Pcs.		
1408PK	9/32" (7mm) Hole Size 9/16" Stem Length 13/32" x 1" Head Size Black Nylon Cowl Insulation Retainers Ford # 384051-S G.M. # 480534	25 Pcs.		
9485PK	9/32" (7mm) Hole Size 3/4" Stem Length 15/16" Head Diameter Black Nylon Door Trim Panel Retainers Chrysler # 6032363 Ford # 385661-S V.W. # N989022	25 Pcs.		
5635PK	9/32" (7mm) Hole Size 20mm Stem Length 25mm Head Diameter 2.56mm-12.96mm Panel Range Black Nylon Interior Trim Retainers Chrysler # 6506788 Ford # N802734S G.M. # 22718305	50 Pcs.		

Ford

Retainers Shield

12127PK	9/32" (7mm) Hole Size 20mm Stem Length 25mm Head Diameter 2.56mm-12.96mm Panel Range Gray Nylon Interior Trim Retainers Ford # N802734-S	50 Pcs.		
9529PK	9/32" (7mm) Hole Size 20mm Stem Length 32mm Head Diameter Gray Nylon Headliner Retainers Ford # N805315	10 Pcs.		
1149PK	9/32" (7mm) Hole Size 20.50mm Stem Length 25mm Head Diameter 2.50mm-13.50mm Panel Range Black Nylon Door Frame Spacer Retainers Chrysler # 4381395, 6501086 Ford # 388904-S, N802224-S	25 Pcs.		
9523PK	9/32" (7mm) Hole Size 1 3/32" Stem Length 1 1/32" Head Diameter Black Nylon Headliner Retainers Ford # W710923-S300 G.M. # 10229437, 10242316	25 Pcs.		
9849PK	9/32" (7mm) Hole Size 27/32" Stem Length 1" Head Diameter .106 - .540" Panel Range Black Nylon Fascia Panel Retainers Ford # 389443-S	25 Pcs.		
13093PK	9/32" (7mm) Hole Size 30mm Stem Length 23mm Head Diameter Black Nylon Cowl, Interior Trim & Splash Shield Retainers Ford # W714076-SS3JA	25 Pcs.		
2048PK	9/32" (7mm) Hole Size 38.50mm Stem Length 26mm Head Diameter .075 - 1.25" Panel Range Black Nylon Interior Trim Retainers Ford # N804349S	25 Pcs.		

Ford

Retainers Shield

JL-120PK 9/32" (7mm) Hole Size
1 3/4" Stem Length
3/4" Head Diameter
.075 - 1.510" Panel Range
Black Nylon
Trim Panel Retainers
Ford # E7EB5802354AAJABH

25 Pcs.

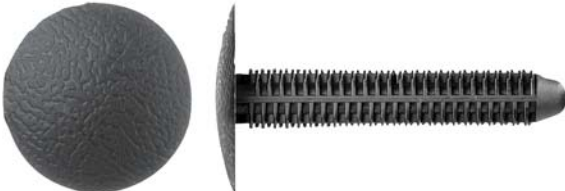

10517PK 19/64" (7.50mm) Hole Size
32mm Stem Length
18mm Head Diameter
Black Nylon
Cowl Vent Retainers
Ford # W710312-S300

25 Pcs.



10675PK 19/64" (7.60mm) Hole Size
22mm Stem Length
18mm Head Diameter
Black Nylon
Radiator Side Shield Retainers
Ford # W7015380-SSW

25 Pcs.



10448PK 5/16" (7.90mm) Hole Size
1-1/2" Stem Length
1" Head Diameter
Gray Nylon
Trim Panel Retainers
Ford # N806344-S

25 Pcs.



5643PK 23/64" (9mm) Hole Size
19.50mm Stem Length
16mm Head Diameter
.060 - .510" Panel Range
Black Nylon
Trim Panel Retainers
Chrysler # 6504043, 650403
Ford # N807721-S

50 Pcs.



10469PK 23/64" (9mm) Hole Size
20mm Stem Length
24mm Head Diameter
1.60-10mm Panel Range
Black Nylon
Front End Retainers
Chrysler # 6505667-AA
Ford # N811540-S, W705681-S300
G.M. # 22189414

25 Pcs.



5648PK 25/64" (10mm) Hole Size
30mm Stem Length
22mm Head Diameter
.040 - .790" Panel Range
Black Nylon
Fascia Bumper Retainers
Chrysler # 34202787
Ford # N804379-S
G.M. # 1631564

50 Pcs.



Retainers Hood Seal











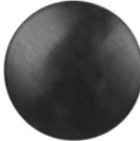

9522PK 15/64" (6mm) Hole Size
10mm Stem Length
14mm Head Diameter
Black Nylon
Hood Insulation Retainers
Mazda # B455-56-741
Ford # F1CZ-16774-A

25 Pcs.

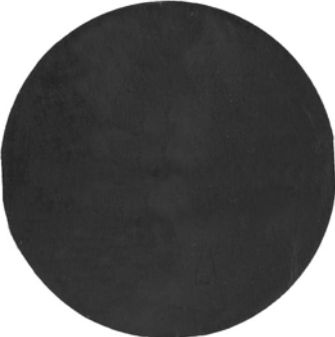

Ford

Retainers Hood Insulation

10613PK	3/16" (4.80mm) Hole Size 12mm Stem Length 19mm Head Diameter Black Nylon Hood Insulation Retainers Ford # W701374-S, W701374-S300	25 Pcs.		
13315PK	15/64 (6mm) Hole Size 9mm Stem Length 20mm Head Diameter Black Nylon Hood Insulation Retainers Mazda # G030-68-885-B-38 Ford # F22Z-16774-A, GA2A-56694	25 Pcs.		
969PK	1/4" (6.30mm) Hole Size 5/8" Stem Length 1/2" x 1 1/2" Head Size Black Nylon Hood Insulation Retainers Chrysler # 6003351 Ford # 385330-S, D30Z-16776-A	25 Pcs.		
2111PK	1/4" (6.30mm) Hole Size 18mm Stem Length 32mm Head Diameter Black Nylon Hood Insulation Retainers Chrysler # 6504098 Ford # N808842-S, W705002-S300	50 Pcs.		
9588PK	1/4" (6.30mm) Hole Size 3/4" Stem Length 1 3/16" Head Diameter Black Nylon Hood Insulation Retainers Ford # 386553-S, 385595-S	50 Pcs.		
1573PK	1/4" (6.30mm) Hole Size 3/4" Stem Length 1 3/4" Head Diameter Black Nylon Hood Insulation Retainers Ford # 388908-S	50 Pcs.		

Ford

Retainers Hood Insulation

9513PK 1/4" (6.30mm) Hole Size
7/8" Stem Length
1 3/4" Head Diameter
Black Nylon
Hood Insulation Retainers
Ford # N803613-S

25 Pcs.

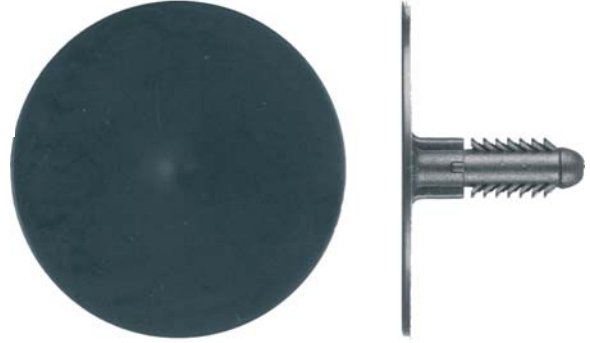

10670PK 1/4" (6.30mm) Hole Size
1" Stem Length
1 3/4" Head Diameter
Black Nylon
Trim Panel Retainers
Chrysler # 6505302AA
Ford # N803387, N803387-S300

25 Pcs.



11852PK 19/64" (7.60mm) Hole Size
13mm Stem Length
31mm Head Diameter
Black Nylon
Hood Insulation Retainers
Ford # W708633-S300

25 Pcs.



10677PK 21/64" (8.50mm) Hole Size
12.50mm Stem Length
25mm Head Diameter
Black Nylon
Hood Insulation Retainers
Ford # W700671-S300

25 Pcs.



Retainers Hood Adjustment

12849PK 6-1.00mm Thread Size
Black Nylon
Metal Insert Threaded
Hood Adjustment Nuts
Ford 1989-On

10 Pcs.



Clips Hood Prop Rod



10076PK 5/16" Rod Size
Natural Nylon
Hood Prop Rod Clips
Ford # 386299-S

25 Pcs.







Ford



Clips Hood Prop Rod



10081PK	5/16" Rod Size Natural Nylon Hood Prop Rod Clips Ford # E83Z-16828A	10 Pcs.		
----------------	--	----------------	---	---



Retainers Weatherstrip

9875PK	11/64" (4.50mm) Hole Size 16mm Stem Length 5 x 13mm Head Size Natural Nylon Weatherstrip Retainers Ford # C5AB-6220586A	50 Pcs.		
---------------	--	----------------	---	---



10663PK	13/64" (5mm) Hole Size 7.80mm Stem Length 5 x 15mm Head Size Yellow Nylon Weatherstrip Retainers Acura, Ford, Honda	100 Pcs.		
----------------	--	-----------------	---	---



15171PK	13/64" (5mm) Hole Size 8mm Stem Length 5 x 15mm Head Size White Nylon Weatherstrip Retainers Ford # W711858-S300	100 Pcs.		
----------------	---	-----------------	---	---

13327PK	13/64" (5mm) Hole Size 8mm Stem Length 5 x 15mm Head Size Orange Nylon Weatherstrip Retainers	100 Pcs.		
----------------	---	-----------------	--	--

10521PK	13/64" (5mm) Hole Size 10mm Stem Length 5 x 14mm Head Size Blue Nylon Weatherstrip Retainers Ford	100 Pcs.		
----------------	--	-----------------	---	---









12069PK	13/64" (5mm) Hole Size 10mm Stem Length 5 x 15mm Head Size Natural Nylon Weatherstrip Retainers Ford # E7GZ-6120586-B Hyundai # 86438-2B000 Mazda # G031-58-762 Toyota # 67867-89103, 97868-89101, 67867-28030	50 Pcs.		
----------------	---	----------------	---	---

12067PK	13/64" (5mm) Hole Size 10mm Stem Length 5 x 15mm Head Diameter Natural Nylon Weatherstrip Retainers Ford # N806340-S	100 Pcs.		
----------------	---	-----------------	---	---









10661PK	13/64" (5.30mm) Hole Size 8.60mm Stem Length 5 x 15mm Head Size Yellow Nylon Door & Hood Seal Weatherstrip Retainers Ford	100 Pcs.		
----------------	---	-----------------	---	---

Ford

Retainers Weatherstrip













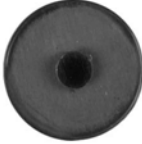



9208PK	15/64" (6mm) Hole Size 10mm Stem Length 5 x 15mm Head Size Orange Nylon Weatherstrip Retainers Ford # N807438S Honda # 91530-SP1-003, 91530-SPL-003, W704643	25 Pcs.		
9264PK	15/64" (6mm) Hole Size 12.30mm Stem Length 5.25 x 14.20mm Head Size Black Nylon Weatherstrip Retainers Ford # N806289-S	50 Pcs.		
10462PK	15/64" (6mm) Hole Size 15.50mm Stem Length 12.60mm Head Diameter .80mm-8mm Panel Range Black Nylon Weatherstrip Retainers Ford # N811040-S G.M. # 10293193	50 Pcs.		
10567PK	17/64" (6.80mm) Hole Size 14.50mm Stem Length 9mm Head Diameter Yellow Nylon Weatherstrip Retainers Ford	100 Pcs.		

Retainers Push Type

9617PK	15/64" (6mm) Hole Size 16mm Stem Length 17mm Flange Diameter Black Nylon Radiator & Fender Push Type Retainers Chrysler # 6506008-AA Ford # W709176-S300 G.M. # 15149708	25 Pcs.		
9320PK	15/64" (6mm) Hole Size 23mm Stem Length 15mm Flange Diameter Black Nylon Push Type Fascia Retainers Chrysler # 4857108 Ford # N803709S G.M. # 15681408, 25642453	50 Pcs.		
10424PK	1/4" (6.30mm) Hole Size 7/16" Stem Length 5/8" Flange Diameter Black Nylon Headlight Bracket Push Type Retainers Ford # 383142-S	50 Pcs.		
5675PK	1/4" (6.30mm) Hole Size 9/16" Stem Length 11/16" Flange Diameter Black Nylon Fender & Mud Skirt Push Type Retainers AMC # 8934-201-621 AMC/Jeep # 6503454 Chrysler # 34201621, 06504090 Ford # E308-4A163CA G.M. # 14019205, 14019206	50 Pcs.		

















Ford

Retainers Push Type

10419PK	1/4" (6.30mm) Hole Size 5/8" Stem Length 19/32" Flange Diameter Black Nylon Fender Shield Push Type Retainers Ford # 387843-S	50 Pcs.		
9858PK	1/4" (6.30mm) Wide Slot 11/16" Stem Length 3/4" Flange Diameter Black Nylon Grille Retainers Ford # 387944-S	50 Pcs.		
12015PK	1/4" (6.30mm) Hole Size 18mm Stem Length 18mm Flange Diameter Black Nylon Stone Deflector Push Type Retainers Ford # N808048-S, W705532-S300	25 Pcs.		
9559PK	1/4" (6.30mm) Hole Size 3/4" Stem Length 19/32" Flange Diameter Black Nylon Wheel Moulding Push Type Retainers Chrysler # 6509103AA, 6509103-AA Ford # W705436-S300 G.M. # 21077123, 20730531	25 Pcs.		
18221PK	1/4" (6.30mm) Hole Size 7/8" Stem Length 11/16" Flange Diameter Black Nylon Body Push Type Retainers Chrysler # 34202672 Ford # N803362-S G.M. # 20510029	25 Pcs.		
2045PK	1/4" (6.30mm) Hole Size 13/16" Stem Length 11/16" Flange Diameter Black Nylon Push Type Retainers Chrysler # 6501925 Ford # F50C-9E728-AA G.M. # 10134407, 15990756	25 Pcs.		
15852PK	1/4" (6.40mm) Hole Size 17/32" Stem Length 5/8" Head Diameter Black Nylon Push Type Retainers Ford # N805231S	50 Pcs.		
5935PK	1/4" (6.30mm) Hole Size 7/8" Stem Length 1" Flange Diameter Black Nylon Splash Shield Push Type Retainers Chrysler # 55176248 Ford # 802781-S, W704340-S300, N802781-S G.M. # 14093088	25 Pcs.		













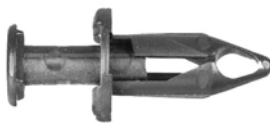

Ford

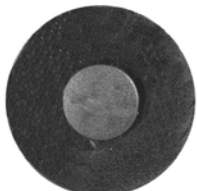
Retainers Push Type

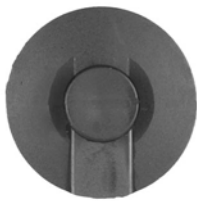
17922PK	1/4" (6.50mm) Hole Size 11mm Stem Length 25mm Flange Diameter Black Nylon Splash & Heat Shield Push Type Retainers Ford # W717823-S300	15 Pcs.		
10368PK	1/4" (6.50mm) Hole Size 17.50mm Stem Length 18mm Flange Diameter 2mm-4.50mm Panel Range Black Nylon Push Type Retainers Chrysler # 6508863AA Ford # W713610-S300 G.M. # 11589289	25 Pcs.		
10369PK	1/4" (6.50mm) Hole Size 20mm Stem Length 18mm Flange Diameter 4.50mm-7mm Panel Range Black Nylon Push Type Retainers Chrysler # 6509049-AA Ford # W714040-S300 G.M. # 11589290	50 Pcs.		
10367PK	1/4" (6.50mm) Hole Size 22mm Stem Length 18mm Flange Diameter 7mm-9.50mm Panel Range Black Nylon Push Type Retainers Ford # W713331-S300 G.M. # 11589291	25 Pcs.		
15027PK	9/32" (7mm) Hole Size 12mm Stem Length 18mm Head Diameter Black Nylon Lower Radiator Shield Push Type Retainers Ford # W716510-S300	10 Pcs.		
15838PK	9/32" (7mm) Hole Size 10mm Stem Length 13mm Flange Diameter Black Nylon Front Fender Push Type Retainers Ford # W707365-S300	10 Pcs.		
9138PK	9/32" (7mm) Hole Size 20mm Stem Length 18mm Head Diameter Black Nylon Fender Apron Push Type Retainers Ford # W718088-S300	25 Pcs.		
12016PK	9/32" (7mm) Hole Size 23mm Stem Length 18mm Head Diameter Black Nylon Fascia Retainers Ford # N803716-S, 803716-S	25 Pcs.		



Ford

Retainers Push Type

5676PK	5/16" (8mm) Hole Size 13.50mm Stem Length 17mm Flange Diameter Black Nylon Radiator Push Type Retainers Chrysler # 175720B010 Ford # 04388293 G.M. # 14071289, 14019226	25 Pcs.		
1861PK	5/16" (8mm) Hole Size 20mm Stem Length 15mm Flange Diameter Black Nylon Rocker Panel Retainers Chrysler # 6504555 Ford # F3LB-14K056-AA G.M. # 21075686	25 Pcs.		
1860PK	5/16" (8mm) Hole Size 20mm Stem Length 20mm Flange Diameter Black Nylon Air Baffle Push Type Retainers Chrysler # 6503598 Ford # N807389S, 807389S G.M. # 21030249, 15969147	25 Pcs.		
10460PK	5/16" (8mm) Hole Size 20.50mm Stem Length 34mm Flange Diameter 3.50mm Shoulder Black & Natural Nylon With Sealer Fascia Retainers Chrysler# 4805405AA Ford # 1L5Z-17K826AA	15 Pcs.		
5940PK	5/16" (8mm) Hole Size 7/8" Stem Length 1" Flange Diameter Black Nylon Splash Shield Push Type Retainers Ford # N804614S, N803934-S G.M. # 20570245, 20635065	25 Pcs.		
1263PK	5/16" (8mm) Hole Size 29/32" Stem Length 1" Flange Diameter 7/64" Shoulder Black Nylon Splash Shield & Fascia Push Type Retainers Chrysler # 6500725, 6501590 Ford # N803421-S	25 Pcs.		
10504PK	5/16" (8mm) Hole Size 26mm Stem Length 20mm Flange Diameter Black Nylon Fender Shield Push Type Retainers Ford # W708530-S300 G.M. # 11518017	15 Pcs.		
10239PK	21/64" (8.30mm) Hole Size 14mm Stem Length 19mm Flange Diameter 2.70mm-5.30mm Panel Range Black Nylon Push Type Retainers Ford # W715537-S300 G.M. # 11609417	50 Pcs.		



















Ford

Retainers Push Type

10374PK	21/64" (8.50mm) Hole Size 22mm Stem Length 20mm Flange Diameter 4.50mm-7mm Panel Range Black Nylon Push Type Retainers Ford # W712196-S300 G.M. # 11589293	25 Pcs.		
12077PK	21/64" (8.50mm) Hole Size 24mm Stem Length 25mm Flange Diameter Black Nylon Front Fender Push Type Retainers Ford # W718365-S300	10 Pcs.		
15517PK	23/64" (9mm) Hole Size 22mm Stem Length 19mm Flange Diameter Gray Nylon Trim, Dash & Console Push Type Retainers Chrysler # 5GC71RC3AA, 5GF92RC3AA Ford # N808791	25 Pcs.		
5678PK	25/64" (10mm) Hole Size 12.50mm Stem Length 16mm Flange Diameter Natural Nylon Push Type Retainers Ford # XL3Z-17E971-AA, XL34-17E971-AA	25 Pcs.		
10518PK	25/64" (10mm) Hole Size 16mm Stem Length 20mm Flange Diameter Black Nylon Radiator Grille Push Type Retainers Chrysler # 6507669-AA, Ford # W714584-S300	25 Pcs.		
10377PK	13/32" (10.50mm) Hole Size 20mm Stem Length 25mm Flange Diameter 3mm-6mm Panel Range Black Nylon Push Type Retainers Chrysler # 5GUU9K11BA Ford # W712665-S300 G.M. # 11589295	15 Pcs.		
10734PK	5/8" (16mm) Slotted Hole 25mm Stem Length 19.80 x 36mm Head Size Black Nylon Bumper Retainers Ford # N.A.	5 Pcs.		
17926PK	8 x 11mm Hole Size 18mm Stem Length 14mm Head Diameter Black Nylon Push Type Retainers Ford # W719367-S300	15 Pcs.		



















Ford

Retainers Phillips Screw

13396PK	13/64" (5mm) Hole Size 9mm Stem Length 8.50 x 12mm Head Size Black Nylon Cowl Vent Screw Type Retainers Ford # 3M8Z-1502316-A Mazda # GJ6W-50-715A	15 Pcs.		
9684PK	1/4" (6.30mm) Hole Size 1/2" Stem Length 11/16" Head Diameter Black Nylon Trim Panel Screw Type Retainers Ford # N806322-S	15 Pcs.		
12472PK	1/4" (6.30mm) Hole Size 14mm Stem Length 15mm Flange Diameter Black Nylon Fender Liner Phillips Screw Retainers G.M. # 94530438 Ford # B04068865A96	25 Pcs.		
1399PK	1/4" (6.30mm) Square Hole 21/32" Stem Length 15/32" x 15/32" Flange Size Black Nylon Trim & Grille Fascia Phillips Screw Retainers Ford # N803494S	25 Pcs.		
9508PK	1/4" (6.30mm) Hole Size 11/16" Stem Length 11/16" Flange Size Black Nylon Phillips Screw Retainers Ford # N808147S G.M. # 10139822, 25680782	25 Pcs.		
11262PK	1/4" (6.30mm) Hole Size 18mm Stem Length 18mm Flange Diameter Black Nylon Phillips Screw Retainers Chrysler # 6508197-AA Ford # W706092-S300	25 Pcs.		
10468PK	1/4" (6.30mm) Hole Size 3/4" Stem Length 11/16" Flange Diameter Black Nylon Trim Panel Phillips Screw Retainers Ford # N807578-S, N808332-S	15 Pcs.		
9240PK	1/4" (6.30mm) Hole Size 3/4" Stem Length 11/16" Flange Diameter Black Nylon Wheelhouse Phillips Screw Retainers Ford # YS4Z-16K262-AA, 96FG16K262AA	25 Pcs.		
9509PK	1/4" (6.30mm) Hole Size 7/8" Stem Length 1" Flange Diameter Black Nylon Interior Trim Phillips Screw Retainers Ford # N-804837-S	50 Pcs.		













Ford

Retainers Phillips Screw



9968PK	1/4" (6.30mm) Hole Size 29/32" Stem Length 5/8" Flange Diameter Black Nylon Phillips Screw Retainers Chrysler # 6502871 Ford # N803946S G.M. # 20664091	50 Pcs.		
9067PK	1/4" (6.30mm) Hole Size 29/32" Stem Length 1 1/16" Flange Diameter Black Nylon Radiator Shroud Phillips Screw Retainers Chrysler # 6502790, 4638136 Ford # N804570-S G.M. # 15773445, 20452072, 22538004, 20664092	25 Pcs.		
9343PK	1/4" (6.30mm) Hole Size 1 1/16" Flange Diameter 1 3/32" Stem Length Black Nylon Phillips Screw Retainers Ford # N807577-S, N808331-S	15 Pcs.		
11918PK	9/32" (7mm) Hole Size 30.50mm Stem Length 12.70mm Head Diameter Black Nylon Phillips Screw Retainers Chrysler # 4696488 Ford # N805026S G.M. # 10195515	25 Pcs.		
9287PK	5/16" (8mm) Hole Size 12mm Stem Length 18mm Flange Diameter Black Nylon Phillips Screw Retainers Ford # MB-455-56143 Hyundai # 86590-28000 Mazda # B092-51-833	10 Pcs.		
10914PK	5/16" (8mm) Hole Size 18mm Stem Length 13mm Flange Diameter Black Nylon Bumper Phillips Screw Retainers Ford # W713445-S300	15 Pcs.		
11338PK	5/16" (8mm) Hole Size 18mm Stem Length 18mm Flange Diameter Black Nylon Bumper Retainers Phillips Screw Type Retainers Ford # W706494-S300	25 Pcs.		
13226PK	5/16" (8mm) Hole Size 18mm Stem Length 18mm Flange Diameter Black Nylon Bumper Retainers Phillips Screw Retainers Ford # W710250-S300	25 Pcs.		
15009PK	5/16" (8mm) Hole Size 18mm Stem Length 18mm Flange Diameter Black Nylon Phillips Screw Retainers Ford # W706713-S300	25 Pcs.		

Ford

Retainers Phillips Screw

5901PK	5/16" (8mm) Hole Size 18mm Stem Length 20mm Flange Diameter Black Nylon Inside Fender Phillips Screw Retainers Ford # MNA01-56145, NA01-56145 Nissan # 63844-01A00	25 Pcs.		
5900PK	5/16" (8mm) Hole Size 18mm Stem Length 20mm Flange Diameter Black Nylon Inside Fender Phillips Screw Retainers Ford # NA01-56145 KIA # MNA01-56-145 Nissan # 63844-01A00	25 Pcs.		
1998PK	25/64" (10mm) Hole Size 18mm Stem Length 20 x 30mm Flange Size Black Nylon Bumper Cover Phillips Screw Retainers Ford # E7GZ-17A904-G Mazda # BF82-50-233, MBF82-50-233 Nissan # 01553-01393	10 Pcs.		
9600PK	25/64" (10mm) Hole Size 11mm Stem Length 20 x 30mm Head Size Nylon Phillips Screw Retainers Ford E7ZG-17A904-B Mazda BF67-50-033	10 Pcs.		
10043PK	25/64" (10mm) Hole Size 20mm Stem Length 20 x 30mm Flange Size Black Nylon Bumper Cover Phillips Screw Retainers Ford # E92Z-17C756C Mazda # GJ21-50-034	10 Pcs.		
11138PK	13/32" (10.30mm) Hole Size 1" Stem Length 27/32" Flange Diameter Black Nylon Phillips Screw Retainers Ford # W708325-S300 G.M. # 11561353, 15672330, 15956470	25 Pcs.		

Retainers Torx Screw Type

11234PK	15/64" (6mm) Hole Size 18mm Stem Length 11mm Flange Diameter Black Nylon Torx Screw Type Retainers Chrysler # 55075139 Ford # W713134-S300 G.M. # 10089262, 21042098	25 Pcs.		
----------------	---	----------------	---	---

Ford

Retainers Miscellaneous

11960PK 6.50 x 12.00mm Hole Size
Black Nylon
Instrument Panel Insulation
Front Sight Shield
Twist Lock Retainers
Ford N811772S
G.M. # 2553596



Clips Door Rod End

9725PK 5/32" Rod Size
17/64" Hole Size
Right Hand Side
Natural Nylon
Door Rod & Hood Clips
AMC # 4003672
Chrysler # 2945108, 4658676
Ford # N805350S
G.M. # 16627328



9726PK 5/32" Rod Size
17/64" Hole Size
Left Hand Side
Black Nylon
Door Rod & Hood Clips
AMC # 4003673
Chrysler # 2945109, 4658677
Ford # N804344S, D2VZ-652195A
G.M. # 9815325, 16607593



9728PK 5/32" Rod Size
17/64" Hole Size
Left Hand Side
Yellow Nylon
Door Lock Rod Clips
Ford # E6AZ-5421952-A, 390523S



9729PK 5/32" Rod Size
17/64" Hole Size
Right Hand Side
Natural Nylon
Door Lock Rod Clips
Ford # 390522S



10078PK #10-24 Rod Size
8mm Hole Size
Fold Over Type
White Nylon
Door Lock Rod Clips
Ford # E6DZ-5421952A, E82Z-5421952B



Clips Tailgate Lock Rod End

9981PK #10-24 Rod Size
8mm Hole Size
2mm Panel Range
Yellow Nylon
Door Lock & Tailgate Rod Clips
Ford # F65Z-1521952-AA, F7DZ-7421952-A
G.M. # 16629990, #16675980













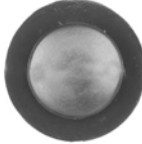

Retainers Door Trim Panel

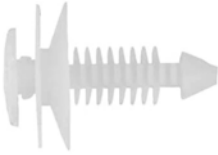
10544PK 9/32" (7mm) Hole Size
13mm Stem Length
15mm Top Head Diameter
White Nylon
Door Trim Panel Retainers
Ford # W701971-S





















Ford

Retainers Door Trim Panel

2112PK	9/32" (7mm) Hole Size 19mm Stem Length 12.50mm Top Head Diameter Black Nylon Door Trim Panel Retainers Chrysler # 6505878AA, 6502709 Ford # N805155-S	50 Pcs.		
9224PK	9/32" (7mm) Hole Size 19mm Stem Length 13.20mm Top Head Diameter Natural Nylon Door Trim Panel Retainers Ford # W707741-S300 G.M. # 21042045, 21042053, 21042058, 21042104	50 Pcs.		
1558PK	9/32" (7mm) Hole Size 19mm Stem Length 13.30mm Top Head Diameter Natural Nylon Door Trim Panel Retainers Ford # N802900 G.M. # 21042958	25 Pcs.		
9514PK	9/32" (7mm) Hole Size 22mm Stem Length 13mm Top Head Diameter Natural Nylon Door Trim Panel Retainers Ford # 389144-S	50 Pcs.		
1648PK	9/32" (7mm) Hole Size 24mm Stem Length 20mm Top Head Diameter White Nylon Door Trim Panel Retainers Ford # 387496-S G.M. # 12084605	25 Pcs.		
12518PK	5/16" (8mm) Hole Size 12mm Stem Length 13mm Top Head Diameter Black and Blue Door Trim Panel Retainers Ford # W711037-S300	25 Pcs.		
9372PK	5/16" (8mm) Hole Size 21/32" Stem Length 1/2" Top Head Diameter White Nylon Door Trim Panel Retainers Ford # 387477-S	50 Pcs.		
1575PK	5/16" (8mm) Hole Size 19mm Stem Length 12.70mm Top Head Diameter Black Nylon Door Trim Panel Retainers Ford # N801925-S, N802900-S	25 Pcs.		
12886PK	5/16" (8mm) Hole Size 3/4" Stem Length 1/2" Top Head Diameter Yellow Nylon Door Trim Panel Retainers Ford # F58Z-16237A02-A	25 Pcs.		

Ford

Retainers Door Trim Panel

1742PK	5/16" (8mm) Hole Size 1" Stem Length 1/2" Top Head Diameter Natural Nylon Door Trim Panel Retainers AMC # 893202-599, 8934-202-599 Ford # N805612-S100, N805612-S G.M. # 10143422	50 Pcs.		
9021PK	5/16" (8mm) Hole Size 1 1/8" Stem Length 1/2" Top Head Diameter Black Nylon Back Seat Door Trim Panel Retainers Ford # 387182-S	25 Pcs.		
9677PK	21/64" (8.50mm) Hole Size 12mm Stem Length 14.50mm Top Head Diameter White Nylon With Sealer Front & Rear Door, Body Side & Wheel Opening Moulding Retainers Ford # W716507-S300	15 Pcs.		
11907PK	21/64" (8.50mm) Hole Size 16mm Stem Length 20mm Flange Diameter Caramel & Natural Trim Panel Retainers Ford # W708621-S300	25 Pcs.		
10612PK	23/64" (9mm) Hole Size 17mm Stem Length 16mm Top Head Diameter White Nylon With Sealer Door Trim Panel Retainers Ford # W713297-S300	25 Pcs.		
10667PK	23/64" (9mm) Hole Size 19.50mm Stem Length 15mm Top Head Diameter Natural Nylon Door Trim Panel Retainers Ford # 1W6Z-238A90-AA	25 Pcs.		
2108PK	3/8" (9.50mm) Hole Size 14mm Stem Length 15mm Top Head Diameter White Nylon Door Trim Panel Retainers Chrysler # 6505292AA Ford # W706812S300	25 Pcs.		
13428PK	3/8" (9.50mm) Hole Size 17.50mm Stem Length 15mm Top Head Diameter White Nylon Rear Door Trim Panel Retainers Ford # W704958-S300	25 Pcs.		
13217PK	25/64" (10mm) Hole Size 14mm Stem Length 15mm Top Head Diameter Green Nylon Lift Gate Door Trim Panel Retainers Ford # W709995-S300	25 Pcs.		

Ford

Retainers Door Trim Panel

18166PK 13/32" (10.50mm) Hole Size
45mm Stem Length
25mm Head Diameter
Black Nylon
Rear Body & Trim Retainers
Ford # W715951-S300

15 Pcs.



Retainers Door Trim Panel Wire Type

9876PK For Thin Panels
Short Leg Type
Wire Type Trim Panel Retainers
Ford # 351050-S3

100 Pcs.



578PK For Thin Panels
Wire Type
Trim Panel Retainers
Ford # 358470
Chrysler # 1900654, 6002823

100 Pcs.



577PK For Thick Panels
Wire Type
Trim Panel Retainers
Ford # 383033-S101

100 Pcs.



Pawls Door Lock

12506PK Left Hand Side
Beige Nylon
Door Lock Pawls
Ford # E6DZ-5421971-A, F3LY-6321971A

10 Pcs.



12507PK Right Hand Side
Pink Nylon
Door Lock Pawls
Ford # E6DZ-5421970-A, F3LY-6321970-A

10 Pcs.



Bushings Door Hinge Pin

1267PK .345" Inside Diameter
.419" Outside Diameter
.295" Height
Door Hinge Pin Bushings
Ford # D1AZ-6522841A
G.M. # 9721917

25 Pcs.



Ford

Bushings Door Hinge Pin

1270PK .348" Inside Diameter
.479" Outside Diameter
.296" Height
Door Hinge Pin Bushings
Ford # D90Z-6522841A

25 Pcs.



Pins Door Hinge

9595PK 3 3/8" Length
1 1/32" Pin Diameter
9/16" Head Outside Diameter
Door Hinge Pins
Ford # D9ZZ-6643030-AA

10 Pcs.



9937PK 3 1/2" Length
1 1/32" Pin Diameter
9/16" Head Outside Diameter
Ford Ranger, F150, F250 & F350
Door Hinge Pins
Ford # E8UZ1522840

5 Pcs.



12319PK .275" Outside Diameter
1.26" Length
Front & Rear
Black Finish
Door Hinge Pins
Ford 82-07, Lincoln 88-06,
Mercury 82-05

5 Pcs.



Rollers Door Hinge Pin

12318PK .887" Outside Diameter
.290" Inside Diameter
.530" Thickness
Front & Rear
White Plastic
Door Hinge Rollers
Ford # E2FZ-5823519-A
Ford 82-07, Lincoln 88-06, Mercury 82-05

5 Pcs.



Kits Door Hinge Pin Roller

12320 Front & Rear
.887" White Roller
1.26" Black Pin
Door Hinge Roller Kit
Ford 82-07, Lincoln 88-06, Mercury 82-05

Sold
Each



Ford

Kits Door Hinge Pin & Bushing

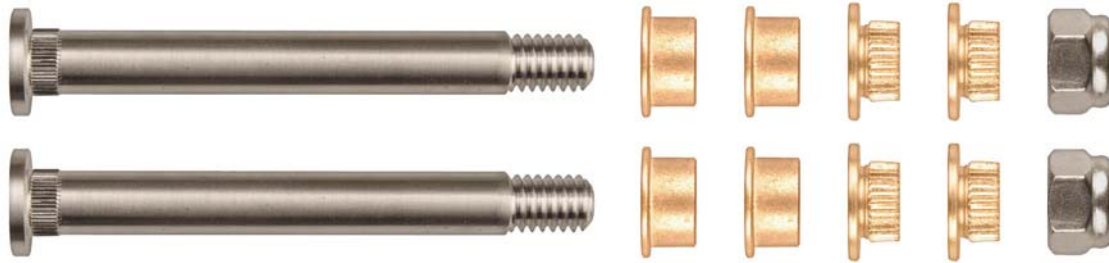

12119 Will Repair Front Door Upper & Lower Hinge
Stainless Steel Pins & Nuts
Door Hinge Pin & Bushing Bracket Repair Kit
Ford Aerostar 86-97, Ford Crown Victoria 82-09,
Ford E-150, Ford E-250, Ford E-350 92-98,
Ford Econoline Cargo & Wagon 99-09,
Ford Explorer 91-05, Ford Explorer Sport 01-03,
Ford Explorer Sport Trac 01-05,
Ford Freestar 04-07, Ford Mustang 94-04, &
Ford Mustang SVT Cobra 94-04

1 Kit

Retainers Headlight

1864PK Zinc Finish
Headlight Component
Retaining Clips
Ford # E9DB-13N020AA, E9DZ-13N129A,
F2AB-13N020-AA

25 Pcs.



10969PK 6-1.00mm Thread
12 x 20mm Hole Size
.70mm-1.80mm Material Thickness
Zinc Organic Headlight Mounting Clips
Ford # W710793-S439

10 Pcs.



Retainers Rearlight

10204PK 5/16" (8mm) Square Hole Size
12mm Stem Length
15mm Top Head Diameter
White Nylon With Sealer
Tail Light Mounting Retainers
Ford # W713579-S300

10 Pcs.



9720PK Rear Light Assembly Retainers
Chrysler # 6502776
Ford # N806624-S191

25 Pcs.



Clips Moulding













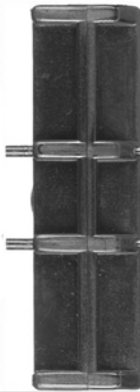

14958PK 9/32" (7mm) Hole Size
9mm Stem Length
13 x 13.50mm Top Head Size
Black & White Nylon W/Sealer
Windshield Moulding Clips
Ford # N.A.

10 Pcs.















Ford

Clips Moulding

12513PK	9/32" (7mm) Hole Size 43mm Stem Length 18mm Head Diameter 10.50mm - 37.50mm Panel Range Black Nylon Rocker Moulding Retainers Ford # W710532-S300	25 Pcs.		
11387PK	5/16" (8mm) Hole Size 15/32" Stem Length 3/4" Flange Diameter White Nylon Exterior Moulding Retainers Ford	10 Pcs.		
2161PK	5/16" (8mm) Hole Size 11/16" Stem Length 9/16" x 2" Top Head Size Black Nylon Rocker Panel Moulding Clips Ford # F1TZ-7810182-A	25 Pcs.		
13209PK	23/64" (9mm) Hole Size 10mm Stem Length 14 x 18mm Top Head Size Blue Nylon Windshield Moulding Clips With Sealer Ford # W790173-S900	10 Pcs.		
10913PK	23/64" (9mm) Hole Size 11mm Stem Length 14 x 18mm Top Head Size White Nylon With Sealer Windshield Moulding Clips Ford # W713590-5300	15 Pcs.		
12896PK	23/64" (9mm) Hole Size 11mm Stem Length 15 x 20mm Top Head Size White Nylon With Sealer Moulding Retainers Ford # W716237-S300	15 Pcs.		
13387PK	23/64" (9mm) Hole Size 12mm Stem Length 14 x 20mm Top Head Size White Nylon With Sealer Moulding Retainers Ford # W710528-S300	15 Pcs.		

Ford

Clips Moulding

15078PK	23/64" (9mm) Hole Size 12mm Stem Length 16 x 23mm Top Head Diameter Gray Nylon Fender Corner & Rocker Moulding Clips Ford # W790225-S900	10 Pcs.		
13090PK	23/64" (9mm) Hole Size 14mm Stem Length 12 x 20mm Top Head Size Black Nylon White Nylon With Sealer Rocker Panel Moulding Retainers Ford # W716352-S300	25 Pcs.		
12545PK	23/64" (9mm) Hole Size 14mm Stem Length 13 x 39mm Top Head Diameter Black Nylon Fender Flare & Rocker Moulding Clips Ford # F6DZ-5410182-AA	10 Pcs.		
14959PK	23/64" (9mm) Hole Size 14mm Stem Length 15 x 20mm Top Head Size White Nylon With Sealer Rocker Panel Moulding Clips Ford # W716503-S300	25 Pcs.		
12986PK	23/64" (9mm) Hole Size 14mm Stem Length 16 x 50mm Head Size Black Nylon Rocker Panel Moulding Clips Ford # F4ZZ-6310182-A	15 Pcs.		
12041PK	23/64" (9mm) Hole Size 14mm Stem Length 20 x 40mm Head Size White Nylon Ground Effects Moulding Clips Ford	10 Pcs.		



Ford

Clips Moulding











12314PK	23/64" (9mm) Hole Size 14mm Stem Length 22 x 48mm Head Size Gray Nylon Rocker Panel Moulding Clips Ford # 6G1Z-5410182-B	15 Pcs.	
15304PK	23/64" (9mm) Hole Size 16mm Stem Length 14 x 18mm Top Head Size White Nylon Rocker Panel Moulding Clips Ford # N/A	10 Pcs.	
13095PK	23/64" (9mm) Hole Size 18mm Stem Length 14 x 20mm Top Head Size White Nylon Wheel Opening Moulding Clips Ford W717736-S300	10 Pcs.	
10066PK	25/64" (10mm) Hole Size 12mm Stem Length 20mm Head Diameter Black Nylon Radiator Shroud Retainers Ford # W708771-S300	50 Pcs.	
14955PK	25/64" (10mm) Hole Size 15mm Stem Length 12 x 20mm Top Head Size White Nylon With Sealer Rocker Panel Moulding Clips Ford # W715201-S300	15 Pcs.	
12919PK	5/16" x 1/2" Hole Size 3/8" Stem Length 1/2" x 13/16" Head Size White Nylon With Sealer Front End Moulding Retainers Ford # W705849-S300 Mazda # 9XG0-73-88X0	10 Pcs.	
9663PK	18mm Wide 37mm Length White Nylon Belt Moulding Clips Ford # N/A	10 Pcs.	
11902PK	18.50mm Width 34.50mm Length White Nylon Door Belt Moulding Clips Ford # N/A	15 Pcs.	
10629PK	11 x 16mm Head Size 19mm Length Gray Nylon Rocker Panel Moulding Clips Ford # 6G1Z-5410182-D	25 Pcs.	

Ford

Clips Moulding

10691PK	42mm From Tip to Tip 12mm Front To Back 21mm Height Black Nylon Roof & Garnish Moulding Clips Ford # 4L3Z-1510182-AA	15 Pcs.		
10742PK	4 x 9mm Hole Size 11mm Stem Length 34mm Across the Top White Nylon With Sealer Drip Moulding Clips Ford	15 Pcs.		
12315PK	22 x 30mm Head Size 18mm Height 9 x 20mm Slot Size Gray Nylon Rocker Panel Moulding Clips Ford # 6G1Z-5410182-A, W716350-S300	15 Pcs.		

Clips Reveal Moulding

1371PK	14.50mm Width 19.50mm Length Black Finish Windshield & Rear Glass Reveal Moulding Clips Ford # E3SB-6342413-AB, E3SZ-6342413-A	50 Pcs.		
12388PK	17mm Width 19.25mm Length Green Finish Windshield & Rear Window Reveal Moulding Clip Ford # C8AZ-63642413-A, D1AB-6542413-AB	100 Pcs.		
9545PK	17.25mm Width 19.50mm Length Black Finish Windshield & Rear Window Reveal Moulding Clips Ford # C8AZ-63642413-A, C8AZ-636442413-A, D1AZ-6542413-AB, D1AB-6542413-AB	100 Pcs.		
9874PK	17.25mm Width 20mm Length Black Finish Rear Window Reveal Moulding Clips Ford # C6AB-6242413-A	100 Pcs.		
9550PK	18mm Width 20.50mm Length Black Finish Windshield & Rear Window Reveal Moulding Clips Ford # C5ZZ-6543413-B, D1AZ-6542113-B, D1AB-6542413-AB	100 Pcs.		

Ford

Clips Universal Moulding

9880PK 3/8" Hole Size
5/16" to 1/2" Wide Moulding
Universal Wire Type
Bright Zinc Finish
Moulding Clips

50 Pcs.



9879PK 10-24 x 3/4" Screw Size
1/2 x 1" Plate Size
Universal
Moulding Clips
Chrysler # 1560058, 6010029
Ford # 358560
G.M. # 568792, 574355, 1165051

25 Pcs.



315PK 13/16" x 2 1/8" Plate Size
Universal
Moulding Clips

25 Pcs.



Clips Window Regulator

13548PK 58.30mm Width
73.50mm Height
39mm Thick
Right Front Door
Window Regulator Clips
Ford Fiesta 2002-2008

Sold
Each



Not Actual Size

Ford

Clips Window Regulator

13549PK	58.30mm Width 73.50mm Height 39mm Thick Left Front Door Window Regulator Clips Ford Fiesta 2002-2008	Sold Each		
			Not Actual Size	
13537PK	59.20mm Width 29.20mm Height 26.90mm Thick Right Front Door Window Regulator Clips Ford Galaxy Land Rover Freelander Volkswagen Alhambra & Sharan	Sold Each		
			Not Actual Size	
13538PK	59.20mm Width 29.20mm Height 26.90mm Thick Left Front Door Window Regulator Clips Ford Galaxy Land Rover Freelander Volkswagen Alhambra & Sharan	Sold Each		
			Not Actual Size	
13544PK	59.40mm Width 34.75mm Height 31mm Thick Right & Left Door Window Regulator Clips Ford Focus 1998-On	2 Pcs.		
			Not Actual Size	
13527PK	59.60mm Width 34.65mm Height 31mm Thick Left Front Door Window Regulator Clip Ford Focus 1998-On	Sold Each		
			Not Actual Size	
13528PK	59.60mm Width 34.65mm Height 31mm Thick Right Front Door Window Regulator Clip Ford Focus 1998-On	Sold Each		
			Not Actual Size	

Ford

Clips Window Regulator

13596PK 88.50mm Width
85mm Height
27.50mm Thick
Left Rear Door
Window Regulator Clip
Ford Focus 2000-2008

**Sold
Each**



13597PK 88.50mm Width
85mm Height
27.50mm Thick
Right Rear Door
Window Regulator Clip
Ford Focus 2000-2008

**Sold
Each**



Dowels Window Regulator

13684PK 25mm Width
19.10mm Height
10.35mm Thick
Natural Nylon
Window Regulator Dowels
Ford Explorer 2002-2005

5 Pcs.



Wheels Window Regulator

13607PK Left or Right Door
49.60mm Outside Diameter
13.90mm Thick
Window Regulator Wheel
BMW X5
Ford Cargo & Connect
Mercedes Axor

**Sold
Each**

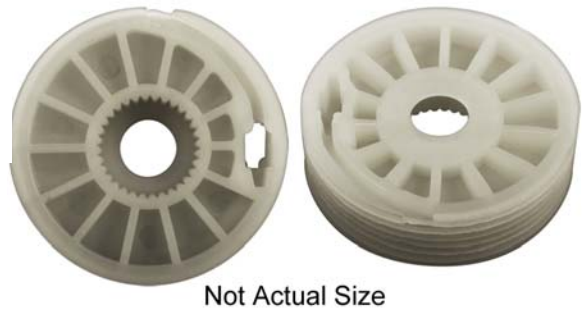

13678PK 47.90mm Outside Diameter
14.50mm Thick
Left & Right Front Doors
Window Regulator Wheel
Ford Escort & Mondeo
Land Rover Freelander/Tailgate Wheel

**Sold
Each**



Ford

Wheels Window Regulator

13570PK 48.20mm Outside Diameter
13mm Thick
Right Front
Window Regulator Wheel
Ford Focus
Volkswagen Polo

**Sold
Each**



Not Actual Size

13598PK 48.50mm Outside Diameter
13mm Thick
Left Front & Rear Doors
Window Regulator Wheel
Ford Focus 1998-2011
Land Rover Freelander
Volkswagen Polo

**Sold
Each**



Not Actual Size

13617PK 52mm Outside Diameter
12.70mm Thick
Left & Right Doors
Window Regulator Wheel
Ford Fiesta 2002-2008
Ford Fusion 2002-2008

**Sold
Each**



Not Actual Size

13603PK 52.60mm Outside Diameter
14.80mm Thick
Left & Right Doors
Window Regulator Wheel
Ford Mondeo 2005
Volkswagen Polo Hatchback Coupe

**Sold
Each**



Not Actual Size

Kits Window Regulator Repair

13748 Left Front Door
Window Regulator Kit
Ford Focus 2001-2005

1 Kit



13749 Right Front Door
Window Regulator Kit
Ford Focus 2001-2005

1 Kit



Ford

Kits Window Regulator Repair

13750 Left Rear Door
Window Regulator Kit
Ford Focus

1 Kit

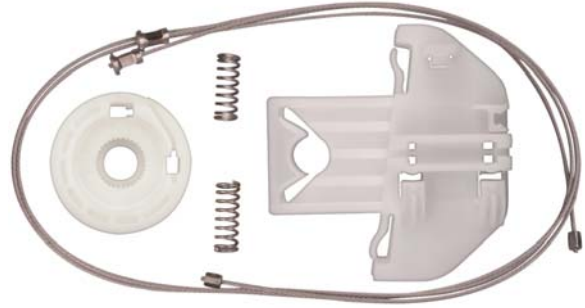

13751 Right Rear Door
Window Regulator Kit
Ford Focus

1 Kit

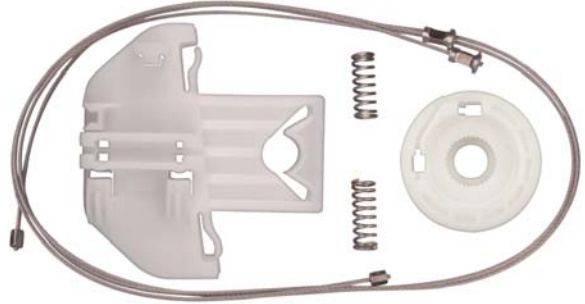

13752 Left Front Door
Window Regulator Kit
Ford Focus 2005-On

1 Kit



13753 Right Front Door
Window Regulator Kit
Ford Focus 2005-On

1 Kit

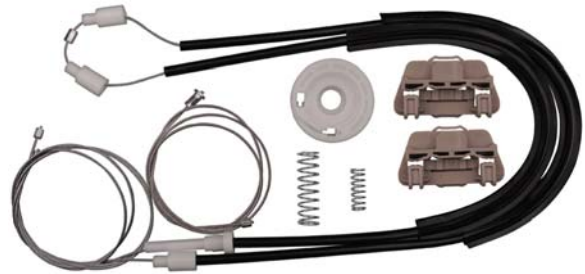

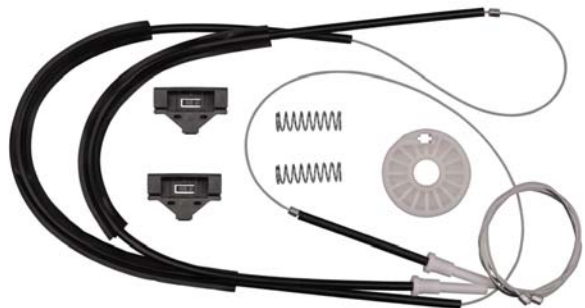

13754 Left & Right Front Doors
Window Regulator Kit
Ford Mondeo 2001-2010

1 Kit

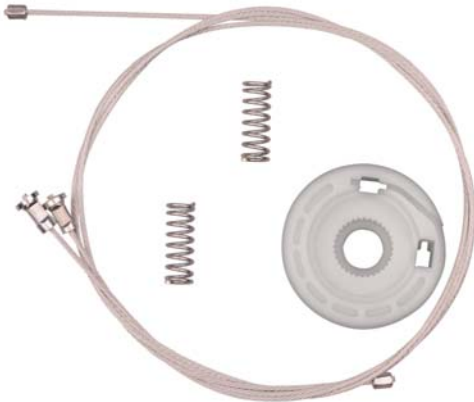
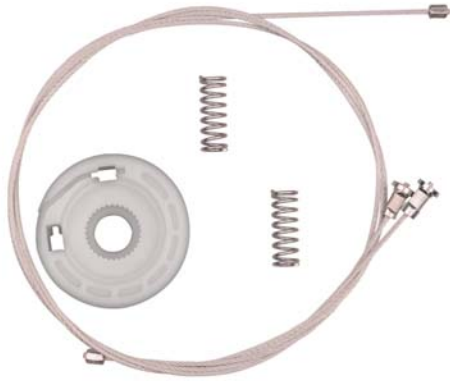

Ford

Kits Window Regulator Repair

13755	Left Rear Door Window Regulator Kit Ford Focus 1998-On	1 Kit	 A photograph of the window regulator kit for the left rear door. It includes a long, thin metal cable with a hook at one end and a connector at the other. Two coiled springs are shown, and a circular metal pulley with a gear-like edge is also visible.
13756	Right Rear Door Window Regulator Kit Ford Focus 1998-On	1 Kit	 A photograph of the window regulator kit for the right rear door. It features a long metal cable with a hook and a connector. Two coiled springs and a circular metal pulley with a gear-like edge are included.
13757	Left Front Door Window Regulator Kit Ford Focus Coupe 1998-2005	1 Kit	 A photograph of the window regulator kit for the left front door. The kit includes a thick black cable with connectors at both ends. Two grey plastic regulator components are shown, along with two coiled springs and a circular metal pulley.
13758	Right Front Door Window Regulator Kit Ford Focus Coupe 1998-2005	1 Kit	 A photograph of the window regulator kit for the right front door. It consists of a thick black cable with connectors, two grey plastic regulator components, two coiled springs, and a circular metal pulley.

Ford

Kits Window Regulator Repair

13759

Right Front Door
Window Regulator Kit
Ford Focus 1998-2001

1 Kit

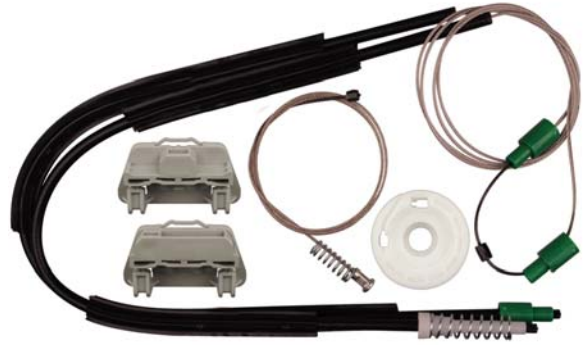

13760

Left Front Door
Window Regulator Kit
Ford Focus 1998-2001

1 Kit

