



















Specialty Nuts





Nuts Barrel

708PK	1/8" Stud Size 5/32" Hole Size Black Finish Barrel Nuts	100 Pcs.		
709PK	1/8" Stud Size 3/16" Hole Size Black Finish Barrel Nuts Ford # 375890-S100	100 Pcs.		
710PK	1/8" Stud Size 1/4" Hole Size Black Finish Barrel Nuts Ford # 375480-S100, 3783794	100 Pcs.		
711PK	3/16" Stud Size 7/32" Hole Size Black Finish Barrel Nuts Chrysler # 6000558	100 Pcs.		
9878PK	3/16" Stud Size 17/64" Hole Size Black Nylon Barrel Nuts Ford # D7VY-6050074-A Renault # 8934-201-767	100 Pcs.		
9941PK	1/4" Stud Size 9/32" Hole Size Black Finish Barrel Nuts Ford # 354341-S	100 Pcs.		

Nuts Flat Type Speed

688PK	1/8" Stud Size 5/16 x 9/16" Plate Size Black Finish Flat Type Speed Nuts	100 Pcs.		
690PK	3/16" Stud Size 3/8 x 5/8" Plate Size Black Finish Flat Type Speed Nuts	100 Pcs.		
9894PK	#10-24 Stud Size 7/16 x 3/4" Plate Size Black Phosphate Finish Flat Type Speed Nuts	100 Pcs.		

Nuts Push On Type Non-Threaded Stud

1684PK	1/8" Stud Size 3/8" Outside Diameter Flange Zinc Finish Push On Type Retainers	100 Pcs.	
1685PK	5/32" Stud Size 7/16" Outside Diameter Flange Zinc Finish Push On Type Retainers	100 Pcs.	
1686PK	3/16" Stud Size 7/16" Outside Diameter Flange Zinc Finish Push On Type Retainers	100 Pcs.	
1687PK	1/4" Stud Size 17/32" Outside Diameter Flange Zinc Finish Push On Type Retainers	100 Pcs.	

Specialty Nuts

Nuts Push On Type Non-Threaded Stud

12655PK 3/8" Screw Size
3/4" Outside Diameter Flange
Zinc Finish
Push On Retainers **100 Pcs.**



Nuts Push On Type Non-Threaded Stud Metric

9850PK 3.20mm Stud Size
9.50mm Outside Diameter Flange
Zinc Finish
Push On Type Retainers
G.M. # 11502794 **100 Pcs.**



1691PK 4mm Stud Size
11mm Outside Diameter Flange
Black Finish
Push On Type Retainers
G.M. **100 Pcs.**



Nuts Push On Type Threaded Stud

9852PK #8 (5/32") Screw Size
3/8" Outside Diameter Flange
Black Finish
Push On Type Retainers **100 Pcs.**



12912PK #10 (3/16") Screw Size
7/16" Outside Diameter Flange
Black Finish
Push On Type Retainers
Chrysler # 6029348 **100 Pcs.**



1273PK 1/4" Screw Size
1/2" Outside Diameter Flange
Black Finish
Push On Type Retainers **100 Pcs.**



1274PK 5/16" Screw Size
5/8" Outside Diameter Flange
Zinc Finish
Push On Type Retainers **100 Pcs.**



989PK 3/8" Screw Size
25/32" Outside Diameter Flange
Black Finish
Push On Type Retainers **100 Pcs.**



990PK 7/16" Screw Size
27/32" Outside Diameter Flange
Black Finish
Push On Type Retainers **100 Pcs.**











991PK 1/2" Screw Size
15/16" Outside Diameter Flange
Black Finish
Push On Type Retainers **100 Pcs.**



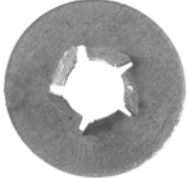

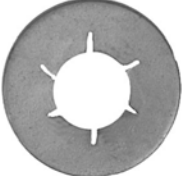









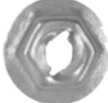

Specialty Nuts

Nuts Push On Type Threaded Stud Metric



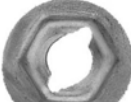



12023PK	5 -0.8mm Screw Size 10mm Outside Diameter Flange Zinc Finish Push On Type Retainers Chrysler # 6100839	100 Pcs.	
1275PK	6-1.00mm Screw Size 12.70mm Outside Diameter Flange Zinc Finish Push On Type Retainers	100 Pcs.	
1621PK	6-1.00mm Screw Size 17mm Outside Diameter Flange Zinc Plated Push On Type Retainers Chrysler # 6501178, 6501192 Ford # N801192S36 G.M. # 11503736, 11609738, 14093869	100 Pcs.	
1043PK	8-1.25mm Screw Size 16mm Outside Diameter Flange Zinc Finish Push On Type Retainers Chrysler # 6501025 G.M. # 11502504, 11502853	100 Pcs.	
3010PK	8-1.25mm Screw Size 24mm Outside Diameter Flange Zinc Finish Bumper Strip Retainers Chrysler # 6501825 G.M. # 10009923	50 Pcs.	
9335PK	10 x 1.50mm Screw Size 20mm Outside Diameter Flange Black Finish Push On Type Retainers G.M. # 11502759	50 Pcs.	
1276PK	10-1.50mm Screw Size 24mm Outside Diameter Flange Dacromet Finish Push On Type Retainers G.M. # 11501849	50 Pcs.	
1044PK	12-1.75mm Screw Size 21.40mm Outside Diameter Flange Black Finish Push On Type Retainers G.M. # 11502737	50 Pcs.	
9952PK	14-2mm Screw Size 25mm Outside Diameter Flange Black Finish Push On Type Retainers G.M. # 11504119	50 Pcs.	

Specialty Nuts

Nuts Thread Cutting

265PK	1/8" Stud Size 5/16" Hex Size 17/32" Flange Diameter Zinc Finish Thread Cutting Nuts	100 Pcs.		
264PK	5/32" Stud Size 3/8" Hex Size 9/16" Flange Diameter Zinc Finish Thread Cutting Nuts	100 Pcs.		
9847PK	3/16" Stud Size 3/8" Hex Size 1/2" Flange Diameter Zinc Finish Thread Cutting Nuts Chrysler # 6006264	200 Pcs.		
263PK	3/16" Stud Size 3/8" Hex Size 5/8" Flange Diameter Zinc Finish Thread Cutting Nuts	100 Pcs.		
262PK	1/4" Stud Size 7/16" Hex Size 19/32" Flange Diameter Zinc Finish Thread Cutting Nuts	100 Pcs.		
9226PK	1/4" Stud Size 7/16" Hex Size 11/16" Flange Diameter Zinc Finish Thread Cutting Nuts	100 Pcs.		
856PK	5/16" Stud Size 1/2" Hex Size 7/8" Flange Diameter Zinc Finish Thread Cutting Nuts	50 Pcs.		

Nuts Thread Cutting Metric

1040PK	4mm Stud Size 9mm Hex Size 15mm Flange Diameter Zinc Finish Thread Cutting Nuts	100 Pcs.		
1041PK	5mm Stud Size 10mm Hex Size 15mm Flange Diameter Black Finish Thread Cutting Nuts G.M. # 11501835, 11508900, 11510062, 11501932	50 Pcs.		
1042PK	6.30mm Stud Size 11mm Hex Size 18mm Flange Diameter Zinc Finish Thread Cutting Nuts G.M. # 11501836, 11503432	50 Pcs.		

Specialty Nuts

Nuts Thread Cutting Metric

1622PK 8mm Stud Size
13mm Hex Size
20mm Flange Diameter
Zinc Finish
Thread Cutting Nuts
G.M. # 11502507, 11509535, 11514282

100 Pcs.



Nuts Lock Zinc Plated

11865PK 1/4"-20 Screw Size
7/16" Hex Size
19/32" Flange Diameter
Zinc Finish
Washer Lock Nuts

100 Pcs.



11140PK 6-1.00mm Stud Size
11mm Hex Size
24mm Flange Diameter
Metallic Gray Finish With Sealer
Locking Washer Nuts
G.M. # 11505865

25 Pcs.

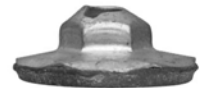

Nuts Hex Flange Type Standard

259PK 10-24 Screw Size
3/8" Hex Size
31/64" Outside Diameter Serrated Flange
Bright Zinc Finish
Hex Flange Nuts

100 Pcs.



11331PK 10-24 Screw Size
3/8" Hex Size
31/64" Outside Diameter Serrated Flange
Black Finish
Hex Flange Nuts

100 Pcs.



9883PK 1/4"-20 Screw Size
7/16" Hex Size
19/32" Outside Diameter Flange
Black Nylon
Hex Flange Nuts

50 Pcs.



Nuts Hex Flange Type Metric

5797PK 5-.80mm Screw Size
8mm Hex Size
11.80mm Outside Diameter Flange
Black Finish
Metric Hex Flange Nuts
G.M. # 11502722, 11502702

50 Pcs.



5800PK 6-1.00mm Screw Size
10mm Hex Size
16mm Outside Diameter Serrated Flange
Black Finish
Metric Hex Flange Nuts

100 Pcs.



11191PK 8-1.25mm Screw Size
13mm Hex Size
17mm Outside Diameter Flange
Black Finish
Metric Hex Flange Nuts
G.M. # 11501889, 11507036, 11502609,
11514518, 11514596

25 Pcs.



Specialty Nuts

Nuts Hex Flange Type Metric

5805PK 8-1.25mm Screw Size
13mm Hex Size
19mm Outside Diameter Serrated Flange
Black Finish
Metric Hex Flange Nuts

100 Pcs.



1017PK 10-1.50mm Screw Size
15mm Hex Size
21mm Outside Diameter Flange
Black Finish
Metric Hex Flange Nuts
G.M. # 11501850

25 Pcs.



Nuts Hex Loose Washer Metric

1639PK 5-.80mm Screw Size
10mm Hex Size
15mm Outside Diameter Loose Washer
Black Finish
Metric Hex Nuts
AMC # 4200408
Ford # N621903-S61, N621903-S2
G.M. # 11504614

50 Pcs.



5910PK 6-1.00mm Screw Size
10mm Hex Size
16mm Outside Diameter Loose Barbed Washer
Black Finish
Metric Hex Nuts
G.M. # 11505329, 11503752
V.W. # N90100001

25 Pcs.



5915PK 6-1.00mm Screw Size
10mm Hex Size
19mm Outside Diameter Loose Barbed Washer
Black Phosphate Finish
Metric Hex Nuts
Chrysler # 6100049, 34201358

25 Pcs.



10838PK 8-1.25mm Screw Size
13mm Hex Size
18mm Outside Diameter Loose Barbed Washer
Black Phosphate Finish
Metric Hex Nuts
Chrysler # 6100050

25 Pcs.



5916XP 8-1.25mm Screw Size
13mm Hex Size
24mm Outside Diameter Loose Barbed Washer
Black Finish
Metric Hex Nuts
Ford # N621940-S424
G.M. # 11503695, 11506117, 11516780,
11500401

25 Pcs.



Nuts Short Type "J"

10053PK #6 (3.50mm) Screw Size
.090"-.110" Panel Range
9/32" Center of Hole to Edge
Black Finish
Short Type "J" Nuts

25 Pcs.



Nuts Speed Type "U" for Sheet Metal Screws















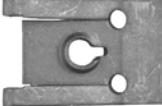

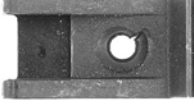

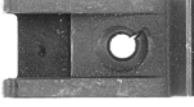

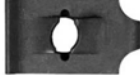
9892PK #6 (3.50mm) Screw Size
.025"-.125" Panel Range
3/8" Center of Hole to Edge
Black Finish
Speed Type "U" Nuts

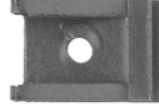
50 Pcs.















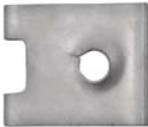



Specialty Nuts

Nuts Speed Type "U" for Sheet Metal Screws

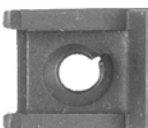



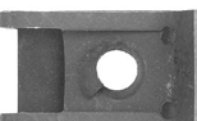

1350PK	#8 (4.20mm) Screw Size .020"-.150" Panel Range 3/8" Center of Hole to Edge Black Finish Speed Type "U" Nuts Ford # 381818-S2, 15650655 G.M. # 9424837, 9431530, 15650655	100 Pcs.		
1350PK25	#8 (4.20mm) Screw Size .020"-.150" Panel Range 3/8" Center of Hole to Edge Black Finish Speed Type "U" Nuts Ford # 381818-S2, 15650655 G.M. # 9424837, 9431530, 15650655	25 Pcs.		
11136PK	#8 (4.20mm) Screw Size .025"-.125" Panel Range 3/8" Center of Hole to Edge Black Finish Speed Type "U" Nuts	25 Pcs.		
5750PK	#8 (4.20mm) Screw Size .025"-.150" Panel Range 5/8" Center of Hole to Edge Black Finish Speed Type "U" Nuts Ford # 381863-S2 G.M. # 9440178, 9433155, 11504531	100 Pcs.		
5750PK50	#8 (4.20mm) Screw Size .025"-.150" Panel Range 5/8" Center of Hole to Edge Black Finish Speed Type "U" Nuts Ford # 381863-S2 G.M. # 9440178, 9433155, 11504531	50 Pcs.		
11040PK	#8 (4.20mm) Screw Size .045"-.062" Panel Range 3/8" Center Of Hole To Edge Black Finish Speed Type "U" Nuts G.M. # 445429, 9422552	50 Pcs.		
1510PK	#8 (4.20mm) Screw Size .125"-.250" Panel Range 3/8" Center of Hole to Edge Black Finish Speed Type "U" Nuts G.M. # 9433156	100 Pcs.		
11954PK	#8 (4.20mm) Screw Size 3mm-4mm Panel Range 7mm Center of Hole to Edge Zinc Finish Speed Type "U" Nuts BMW # 0712-9-925-708 Mercedes # 000-994-25-45	50 Pcs.		
13350PK	#8 (4.20mm) Screw Size .50mm-2.50mm Panel Range 14mm Center Of Hole To Edge Zinc & Yellow Finish Speed Type "U" Nuts Mercedes # 123-994-08-45	25 Pcs.		
5751PK	#10 (4.80mm) Screw Size .025"-.150" Panel Range 11/32" Center of Hole to Edge Black Finish Speed Type "U" Nuts	25 Pcs.		

Specialty Nuts

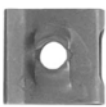
Nuts Speed Type "U" for Sheet Metal Screws









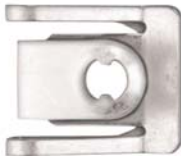

5752PK	#10 (4.80mm) Screw Size .025"-.150" Panel Range 19/32" Center of Hole to Edge Black Finish Speed Type "U" Nuts	50 Pcs.		
13301PK	#10 (4.80mm) Screw Size .80mm-1.70mm Panel Range 11mm Center of Hole to Edge Zinc Finish Speed Type "U" Nuts BMW # 0711-9-916-945 Mercedes # 000-994-14-45	50 Pcs.		 NEW!
11286PK	#10 (4.80mm) Screw Size .50mm-1.70mm Panel Range 7mm Center of Hole to Edge Zinc Finish Speed Type "U" Nuts BMW # 0712-9-925-737, 07-12-9-901-651 Mercedes # 000-994-06-45, 003-994-30-45	50 Pcs.		 NEW!
11915PK	#10 (4.80mm) Screw Size .90mm-2mm Panel Range 8mm Center of Hole to Edge Zinc Finish Speed Type "U" Nuts Mercedes # 000-994-14-45	25 Pcs.		 NEW!
13434PK	#10 (4.80mm) Screw Size 2.30mm-3.50mm Panel Range 8.50mm Center of Hole to Edge Zinc Finish Speed Type "U" Nuts BMW # 07129904150	25 Pcs.		 NEW!
1192PK	#14 (6.30mm) Screw Size .025"-.150" Panel Range 3/8" Center of Hole to Edge Black Finish Speed Type "U" Nuts G.M. # 9431532	25 Pcs.		
11128PK	#14 (6.30mm) Screw Size .025"-.150" Panel Range 3/8" Center of Hole to Edge Zinc Organic Finish Speed Type "U" Nuts Nissan # 08967-1065A	25 Pcs.		
5753PK	#14 (6.30mm) Screw Size .025"-.150" Panel Range 5/8" Center of Hole to Edge Black Finish Speed Type "U" Nuts	25 Pcs.		

Nuts Speed Type "U" for Machine Screws







9866PK	8-32 Screw Size .110"-.125" Panel Range 9/32" Center of Hole to Edge Black Finish Speed Type "U" Nuts	25 Pcs.		
9897PK	10-24 Screw Size .045"-.062" Panel Range 17/32" Center of Hole to Edge Black Finish Speed Type "U" Nuts	100 Pcs.		
9848PK	1/4"-20 Screw Size .064"-.125" Panel Range 9/16" Center of Hole to Edge Black Finish Speed Type "U" Nuts G.M. # 9431647, 22529733	100 Pcs.		

Specialty Nuts

Hardware Skid Plate







16990PK	4.50mm Stud Size 13mm Center of Hole to Edge Zinc Finish Skid Plate "U" Nuts Use With # 16991 Audi # 8K0-805-922A	15 Pcs.		
16991PK	1 1/64" (4.50mm) Hole Size 18.50mm Stem Length 16mm Head Diameter Black Finish Phillips Drive Cowl Fasteners Use With 16990 V.W. # 8K0-805-121	10 Pcs.		
13254PK	6mm Stud Size 12.20mm Center of Hole to Edge Zinc Finish Speed Type "U" Nuts For Nylon Screws Use With # 13253 & 1655 V.W. # 8D0805960	10 Pcs.		
1655PK	8mm Bolt Size 8.40mm Inside Diameter 17mm Outside Diameter Bright Zinc Finish Metric Flat Washers Use With # 13253 & 13254	100 Pcs.		
13253PK	9/32" (7mm) Hole Size 20mm Stem Length 18mm Head Diameter Black Finish Steel Slotted Drive Cowl Fasteners Use With # 13254 & 1655 V.W. # 8D0-805-121B	10 Pcs.		

Nuts Splash Shield Retaining Metric









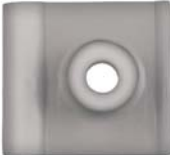

15730PK	5mm Stud Size 30mm Outside Diameter Flange Dacromet Finish Splash Shield & Wheel Well Push Type Retainers V.W. # N90-335-006	25 Pcs.		
13260PK	5-2.12 x 19mm 14mm Head Diameter T25 Drive Size Black Finish Torx® Truss Head Screws Use with 10937 & 13256 V.W. # N90892001, N90775001	25 Pcs.		
10937PK	5mm Torx Screw Size 30mm Outside Diameter Flange Zinc Finish Splash Shield Retainers Use with 13260 & 13256 V.W. # N90-796-502, N90-335-004	25 Pcs.		

Specialty Nuts

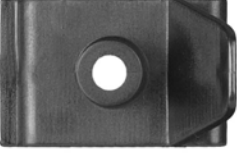
Nuts Splash Shield Retaining Metric













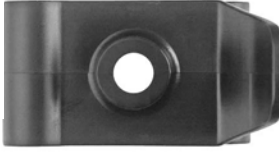



13256PK	5-2.12 Screw Size 8mm Stem Length 7.50 x 13mm Hole Size Zinc Finish Splash Shield Retaining Nuts Use with 13260 & 10937 V.W. # N10327101, N10327102	25 Pcs.		
17932PK	14mm Hex Size 30mm Flange Diameter Black Nylon Wheel Well Liner & Splash Shield Nuts Hyundai # 84145-26000	15 Pcs.		
15868PK	8.50mm x 11.00mm Hole Size 36mm Stem Length 18mm Head Diameter Black Nylon Rocker Panel & Splash Shield Screw Grommet With Specialty Screw Chrysler # 6510123AA	5 Pcs.		

Nuts Nylon "U" Type Metric

15214PK	#10 (4.80mm) Screw Size 11mm Center of Hole to Edge Up to 1mm Panel Range Gray Nylon "U" Type Nuts Mazda # B455-56-135	25 Pcs.		
18105PK	#10 (4.80mm) Screw Size Up to 1mm Panel Range 11mm Center of Hole to Edge Gray Nylon Front Bumper "U" Type Nuts Mazda # C274-50-133	25 Pcs.		
1601PK	#10 (4.80mm) Screw Size 11mm Center of Hole to Edge Up to 1.00mm Panel Range Black Nylon Fender Wheel Housing "U" Type Nuts G.M. # 94841226 Mazda LA01-56-135 Toyota # 53879-14010-A, 53879-14020, 53879-22030	15 Pcs.		
12898PK	#10 (4.80mm) Screw Size 8mm Center of Hole to Edge Up to 1.50mm Panel Range White Nylon "U" Type Nuts Nissan # 76882-0M000	15 Pcs.		
12494PK	#10 (4.80mm) Screw Size 14mm Center of Hole to Edge Up to 3mm Panel Range Black Nylon "U" Type Nuts Toyota # 90179-05060	10 Pcs.		

Specialty Nuts

Nuts Nylon "U" Type Metric

11161PK	#12 (5.50mm) Screw Size 9mm Center of Hole to Edge Up to 1.00mm Panel Range Black Nylon "U" Type Nuts Nissan # 63848-D0100	15 Pcs.		
11421PK	#12 (5.50mm) Screw Size 14mm Center of Hole to Edge Up to 1.00mm Panel Range Black Nylon "U" Type Nuts Toyota # 90467-05114	10 Pcs.		
9530PK	#12 (5.50mm) Screw Size 9mm Center of Hole to Edge Up to 2mm Panel Range Black Nylon Inner Fender "U" Type Nuts Nissan # 63848-D4000, 63848D4001	10 Pcs.		
15729PK	#12 (5.50mm) Screw Size Up To 2mm Panel Range 12mm Center Of Hole to Edge Red Nylon "U" Type Nuts Use With # 10123 G.M. # 24449408	25 Pcs.		
10123PK	5.5mm x 20mm Torx® Truss Head 15mm Outside Diameter Washer Black Zinc Finish Screws Use With # 15729 G.M. # 13144822	25 Pcs.		
1606PK	#14 (6.30mm) Screw Size 15mm Center of Hole to Edge Up to 1.00mm Panel Range Black Nylon Fender Wheel Housing "U" Type Nuts Toyota # 53879-22010	15 Pcs.		
10785PK	#14 (6.30mm) Screw Size 8mm Center of Hole to Edge Up to 1.50mm Panel Range Black Nylon Wheel Guard "U" Type Nuts Hyundai # 86825-28800	25 Pcs.		
11388PK	#14 (6.30mm) Screw Size 12mm Center of Hole to Edge Up to 2mm Panel Range Dark Red Nylon Front Bumper "U" Type Nuts Toyota # 90467-A0018, 90467-05081, 90084-46019	15 Pcs.		

Specialty Nuts

Nuts Nylon "U" Type Metric

15083PK #14 (6.30mm) Screw Size
14mm Center of Hole to Edge
Up to 3mm Panel Range
Black Nylon Front Bumper & Fender Liner
"U" Type Nuts
Toyota # 90467-05138

15 Pcs.



Not Actual Size

Nuts Extruded Type "U" Standard

938PK 10-24 Screw Size
15/32" Center of Hole to Edge
.025"-.150" Panel Range
Black Finish
Extruded "U" Nuts
Chrysler # 149251
G.M. # 152273

50 Pcs.



938ZPK 10-24 Screw Size
15/32" Center of Hole to Edge
.025"-.125" Panel Range
Bright Zinc Finish
Extruded "U" Nuts

50 Pcs.



2969PK 1/4"-20 Screw Size
17/32" Center of Hole to Edge
.010"-.165" Panel Range
Black Finish
Extruded "U" Nuts
Ford # 45263-S2
G.M. # 1494252, 1480627

25 Pcs.



2969ZYPK 1/4"-20 Screw Size
17/32" Center of Hole to Edge
.010"-.165" Panel Range
Yellow Zinc Finish
Extruded "U" Nuts

25 Pcs.



5480PK 1/4"-20 Screw Size
25/32" Center of Hole to Edge
.010"-.165" Panel Range
Black Finish
Extruded "U" Nuts
Ford # 45267
G.M. # 1494257

25 Pcs.



1835PK 5/16"-18 Screw Size
5/8" Center of Hole to Edge
.025"-.125" Panel Range
Black Finish
Extruded "U" Nuts
Chrysler # 3786805
G.M. # 1494253

25 Pcs.



1836PK 5/16"-18 Screw Size
27/32" Center of Hole to Edge
.010"-.170" Panel Range
Black Finish
Extruded "U" Nuts
Ford # 379831-S
G.M. # 1494258

25 Pcs.



5412PK 3/8"-16 Screw Size
3/4" Center of Hole to Edge
.035"-.205" Panel Range
Black Finish
Extruded "U" Nuts
Ford # 45265-S2
G.M. # 1494254, 12337873

25 Pcs.



Specialty Nuts

Nuts Extruded Type "U" Standard

5466PK 3/8"-16 Screw Size
1 1/8" Center of Hole to Edge
.035"-.220" Panel Range
Black Finish
Extruded "U" Nuts
Ford # 45269, 45269-S



Nuts Extruded Type "U" Metric

10795PK #8 (4.20-1.41mm) Screw Size
9.50mm Center of Hole to Edge
.65mm-3.80mm Panel Range
Zinc Organic Prevailing Torque
Extruded "U" Nuts
G.M. # 11513599
Ford # W704823-S439



10726PK #8 (4.20-1.41mm) Screw Size
10mm Center of Hole to Edge
.50mm-2.00mm Panel Range
Zinc Organic Prevailing Torque
Extruded "U" Nuts
G.M. # 11516397



11339PK #8 (4.20-1.41mm) Screw Size
10.10mm Center of Hole to Edge
2mm-3mm Panel Range
Prevailing Torque 6.28 In-lbs
Black Finish
Extruded "U" Nuts
G.M. # 11513700



11043PK #8 (4.20-1.41mm) Screw Size
15mm Center of Hole to Edge
.65-3.80mm Panel Range
Zinc Organic Prevailing Torque
Extruded "U" Nuts
G.M. # 11515638



1021PK 4-.70mm Screw Size
13.50mm Center of Hole to Edge
.80mm-4mm Panel Range
Black Finish
Extruded "U" Nuts
G.M. # 11500655



1012PK 5-.80mm Screw Size
8mm Center of Hole to Edge
.80mm-4mm Panel Range
Black Finish
Extruded "U" Nuts
G.M. # 11500657, 11504693



12893PK 5-.80mm Screw Size
11mm Center of Hole to Edge
.60mm-3.80mm Panel Range
Black Finish
Extruded "U" Nuts
Ford # N623331-S2, W520821-S439,
W520821-S426
G.M. # 11505596, 11500656























11038PK 6-1.00mm Screw Size
10.50mm Center of Hole to Edge
2.70mm-3.50mm Panel Range
Black Finish
Extruded "U" Nuts
Chrysler # 6503347



Specialty Nuts

Nuts Extruded Type "U" Metric

10836PK	6-1.00mm Screw Size 13.50mm Center of Hole to Edge .80mm-4mm Panel Range Black Phosphate Organic Finish Prevailing Torque Extruded "U" Nuts Chrysler # 6101308 Ford # N800854-S1 G.M. # 11509005	25 Pcs.		
5596PK	6-1.00mm Screw Size 13.50mm Center of Hole to Edge .80mm-4mm Panel Range Black Finish Extruded "U" Nuts Ford # N623332, N623332-S2, N623332-S53, N623332-S100 G.M. # 11503957, 11503716, 1016937	25 Pcs.		
9512PK	6-1.00mm Screw Size 13.50mm Center of Hole to Edge 3.40mm-6.30mm Panel Range Black Finish Extruded "U" Nuts Ford # N802331-S53 G.M. # 11504047	25 Pcs.		
9949PK	6-1.00mm Screw Size 14mm Center of Hole to Edge .50mm-2.30mm Panel Range GM 4435-M Finish Prevailing Torque Extruded "U" Nuts G.M.	25 Pcs.		
11030PK	6-1.00mm Screw Size 14mm Center of Hole to Edge .80mm-2mm Panel Range Zinc Organic Extruded "U" Nuts G.M. # 11570097	15 Pcs.		
13432PK	6-1.00mm Screw Size 14.50mm Center of Hole to Edge 2mm-4mm Panel Range Zinc Finish Extruded "U" Nuts Honda # 90675-SA5-003	25 Pcs.		
5650PK	6-1.00mm Screw Size 19.50mm Center of Hole to Edge 1.00mm-2.50mm Panel Range Black Finish Extruded "U" Nuts Ford # W520832-S424, W520832-S426 G.M. # 11503715, 11506099, 11508241	25 Pcs.		
10812PK	6-1.00mm Screw Size 25/32" Center of Hole to Edge .010 - .165" Panel Range Black Phosphate Finish Extruded "U" Nuts G.M. # 11503715	25 Pcs.		
5559PK	6.3-1.00mm Screw Size 13.50mm Center of Hole to Edge .80mm-4mm Panel Range Black Finish Extruded "U" Nuts G.M. # 11500658, 9433043, 11502785	25 Pcs.		
5560PK	8-1.25mm Screw Size 14.50mm Center of Hole to Edge .80mm-4mm Panel Range Black Finish Extruded "U" Nuts Chrysler # 6100042, 6101283 Ford # N623333-S2, N623333-S100 G.M. # 11500660, 11508925, 11502617	25 Pcs.		

Specialty Nuts

Nuts Extruded Type "U" Metric



















5557PK	8-1.25mm Screw Size 20mm Center of Hole to Edge .80mm-4.50mm Panel Range Black Finish Extruded "U" Nuts Ford # N623343-S100, N623343-S2 G.M. # 11500661, 11503317, 11516150	25 Pcs.		
5558PK	10-1.50mm Screw Size 19mm Center of Hole to Edge .90mm-6.00mm Panel Range Black Finish Extruded "U" Nuts G.M. # 11500662, 22531616	25 Pcs.		

Nuts Nylon

9665PK	#4 (2.80mm) Screw Size 16mm Stem Length 12mm Head Diameter 7 x 7mm Square Hole White Nylon With Sealer Screw Grommets Nissan # 01281-01121	10 Pcs.		
11414PK	#4 (2.90mm) Screw Size 7mm Stem Length 13mm Head Size 8.40 x 8.60mm Hole Size Natural Nylon Door Trim Grommets Honda # 90866-SA0-000	25 Pcs.		
12634PK	#4 (2.90mm) Screw Size 14mm Stem Length 9mm Head Size 7mm Hole Size Natural Nylon Side Moulding Screw Grommets Lexus # 90189-04207	25 Pcs.		
2157PK	#4 (2.90mm) Screw Size 17mm Stem Length 13mm Head Diameter 7mm Hole Size Natural Nylon Center Pillar Screw Grommets Honda # 91620-SR2-003	10 Pcs.		
11193PK	#6 (3.50mm) Screw Size 6.50mm Stem Length 9.60mm Head Size 6.00 x 6.50mm Hole Size Natural Nylon With Sealer Rear Bumper Grommets G.M. # 11589183	50 Pcs.		
10808PK	#6 (3.50mm) Screw Size 7mm Stem Length 12 x 18mm Head Size 6 x 14mm Hole Size White Nylon Rocker Trim Screw Grommets Lexus # 90189-04059	25 Pcs.		
1297PK	#6 (3.50mm) Screw Size 5/16" Stem Length 13/32" Head Size 9/32" Hole Size Natural Nylon Headlight Screw Grommets Chrysler # 6029501 G.M. # 1370853 V.W. # 179-813-883, 155-809-966	50 Pcs.		



















Specialty Nuts

Nuts Nylon

9112PK	#6 (3.50mm) Screw Size 8mm Stem Length 12mm Head Size 7 x 7.50mm Hole Size Natural Nylon Screw Grommets Toyota # 90189-04011, 90189-04057	25 Pcs.		
1978PK	#6 (3.50mm) Screw Size 8mm Stem Length 12 x 16mm Head Size 6 x 10mm Hole Size Natural Nylon Screw Grommets Isuzu # 8941340270 Toyota # 90189-05012	50 Pcs.		
9873PK	#6 (3.50mm) Screw Size 8mm Stem Length 12.50mm Head Diameter 7 x 7.50mm Hole Size Natural Nylon Headlight Door to Radiator Grille Grommets G.M. # 1355003	50 Pcs.		
1227PK	#6 (3.50mm) Screw Size 8.50mm Stem Length 9 x 13mm Head Size 6.50 x 9mm Hole Size Black Nylon Front Fender Screw Grommets Ford # N-800503S	50 Pcs.		
9111PK	#6 (3.50mm) Screw Size 8.50mm Stem Length 10mm Head Size 6.50 x 7.50mm Hole Size Natural Nylon Headlight Screw Grommets AMC # 400141 G.M. # 380382 Mitsubishi # MS480001	50 Pcs.		
1202PK	#6 (3.50mm) Screw Size 8.50mm Stem Length 13 x 17mm Head Size 7 x 15mm Hole Size Natural Nylon Grille Attachment Screw Grommets G.M. # 14032291	50 Pcs.		
637PK	#6 (3.50mm) Screw Size 9mm Stem Length 14 x 21mm Head Size 7 x 18.50mm Hole Size Natural Nylon Rear Bumper Bar Screw Grommets G.M. # 1377030	100 Pcs.		
9085PK	#6 (3.50mm) Screw Size 3/8" Stem Length 15/64 x 23/64" Head Size 15/64" Hole Size White Nylon Marker Light Screw Grommets G.M. # 1254815	50 Pcs.		
15148PK	#6 (3.50mm) Screw Size 9.50mm Stem Length 11.50mm Head Diameter 7mm Hole Size Natural Nylon Screw Grommets Nissan # 96706-H2500	25 Pcs.		



















Specialty Nuts

Nuts Nylon

11147PK	#6 (3.50mm) Screw Size 10mm Stem Length 12mm Head Diameter 6.60mm Hole Size Gray Nylon With Sealer Rear Hatch Screw Grommets Acura # 91601-STX-A00	10 Pcs.		
9591PK	#6 (3.50mm) Screw Size 10mm Stem Length 14mm Head Diameter 7mm Hole Size Natural Nylon With Sealer Screw Grommets Honda # 90662-693-0030, 90662-693-003, 90662-693-0031 Toyota # 90189-04066	25 Pcs.		
17939PK	#6 (3.50mm) Screw Size 12mm Stem Length 8 x 10mm Head Size White Nylon Bumper Grommet Hyundai # 86518-3M000	25 Pcs.		
10619PK	#6 (3.50mm) Screw Size 12mm Stem Length 12 x 16mm Head Size Blue Nylon With Sealer Windshield Moulding Grommets Nissan # 76848-50Y00	10 Pcs.		
13344PK	#6 (3.50mm) Screw Size 14mm Stem Length 9.50mm Head Size 6.50 x 7mm Hole Size Black Nylon Cowl Vent Nuts Mercedes # 639-998-01-85 Mercedes # 000-988-16-25	25 Pcs.		
1636PK	#6 (3.50mm) Screw Size 15mm Stem Length 14.50mm Head Diameter 7mm Hole Size Natural Nylon Screw Grommets Honda # 90672-671-8110M1 Toyota # 90189-04013	25 Pcs.		
10715PK	#6 (3.50mm) Screw Size 16mm Stem Length 22 x 23.50mm Head Size 15mm Hole Size Black Nylon Headlight Screw Grommets Ford # W712160-S300	15 Pcs.		
2156PK	#6 (3.50mm) Screw Size 16.50mm Stem Length 8mm Head Size 7mm Hole Size Natural Nylon With Sealer Body Side Screw Grommets Nissan # 01281-00501	15 Pcs.		
1407PK	#6 (3.50mm) Screw Size 16.50mm Stem Length 14.70 x 20.80mm Head Size 7.10 x 20.30mm Hole Size Black Nylon High Torque Screw Grommets AMC # 8934-201-602 Chrysler # 6031869 G.M. # 10032838, 1264963	25 Pcs.		



















Specialty Nuts

Nuts Nylon

11863PK	#6 to #8 Screw Size 8.30mm Stem Length 11 x 13.60mm Head Size Black Nylon Cowl Vent Nuts Chrysler # 6035274 G.M. # 15596280	25 Pcs.		
11185PK	#8 (4.20mm) Screw Size 5mm Stem Length 15mm Head Diameter 8mm Hole Size Gray Nylon Rear Bumper Fascia Grommets Honda # 90651-SL9-013	15 Pcs.		
10993PK	#8 (4.20mm) Screw Size 6.40mm Stem Length 10 x 16mm Head Size 7 x 11.40mm Hole Size Black Nylon Front Fascia Grommets Honda # 90107-SOX-A01	15 Pcs.		
1577PK	#8 (4.20mm) Screw Size 6.50mm Stem Length 10mm Head Size 6 x 7mm Hole Size Natural Nylon Side Marker Light Screw Grommets Honda # 75522-611-000, 75522-611-0000 Mazda # 9991-00-412 Mitsubishi # MS-480001 Nissan # 96706-B0700, 97606-B0700 Toyota # 90189-04042, 95900-04036	50 Pcs.		
2940PK	#8 (4.20mm) Screw Size 17/64" Stem Length 31/64" Head Size 5/16" Hole Size Natural Nylon Headlamp Screw Grommets G.M. # 14013246	50 Pcs.		
9050PK	#8 (4.20mm) Screw Size 17/64" Stem Length 17/32" Head Size 11/32" Hole Size Natural Nylon Grille Screw Grommets G.M.	50 Pcs.		
12902PK	#8 (4.20mm) Screw Size 7mm Stem Length 10mm Head Size 7mm Hole Size Natural Nylon Screw Grommets Toyota # 90189-04014	50 Pcs.		
1574PK	#8 (4.20mm) Screw Size 9/32" Stem Length 7/16" Head Size 5/16" Hole Size Natural Nylon Grille Screw Grommets G.M. # 3919773, 22649878, 22649879	100 Pcs.		
2980PK	#8 (4.20mm) Screw Size 9/32" Stem Length 7/16" Head Size 5/16" Hole Size Natural Nylon Grille Screw Grommets G.M. # 3893980, 347347	50 Pcs.		



















Specialty Nuts

Nuts Nylon

1997PK	#8 (4.20mm) Screw Size 8mm Stem Length 13mm Head Diameter 7.50mm Hole Size Black Nylon Tail Light Screw Grommets G.M. # 3997391 V.W. # 179-813-881	25 Pcs.		
11143PK	#8 (4.20mm) Screw Size 8mm Stem Length 17mm Head Diameter 9mm Hole Size Natural Nylon Headlight Mounting Nuts Toyota # 90189-05142	25 Pcs.		
12667PK	#8 (4.20mm) Screw Size 8.50mm Stem Length 9.70mm Head Diameter 6.50 x 7.50mm Hole Size Natural Nylon With Sealer Screw Grommets G.M. # 9669486 Renault # 8934-201-262	25 Pcs.		
9113PK	#8 (4.20mm) Screw Size 9mm Stem Length 10mm Head Size 7mm Hole Size Natural Nylon Radiator Grille Screw Grommets Chrysler # 6000943 Renault # 8934-201-263	100 Pcs.		
12465PK	#8 (4.20mm) Screw Size 9.50mm Head Size 6mm Hole Size White Nylon Screw Grommets Honda # 34301-692A-0000	50 Pcs.		
9683PK	#8 (4.20mm) Screw Size 9mm Stem Length 12 x 12mm Square Head 10mm Hole Size Natural Nylon Door Handle Nuts Hyundai # 14910-05000	25 Pcs.		
11898PK	#8 (4.20mm) Screw Size 10mm Stem Length 12.50 x 14.50mm Head Size Black Nylon Radiator Grille Nuts Chrysler # 6031234	25 Pcs.		
10783PK	#8 (4.20mm) Screw Size 10mm Stem Length 14mm Head Size 8 x 12mm Hole Size White Nylon With Sealer Body Moulding Screw Grommets Hyundai #87756-3D000	15 Pcs.		
10922PK	#8 (4.20mm) Screw Size 10mm Stem Length 14.50 x 16.70mm Head Size Maroon Nylon Scuff Plate Screw Grommets V.W. # 1J0-853-120	15 Pcs.		















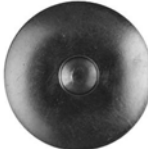

Specialty Nuts

Nuts Nylon

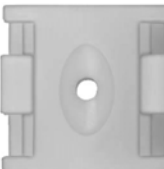
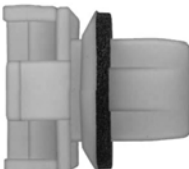
10636PK	#8 (4.20mm) Screw Size 10mm Stem Length 16mm Head Diameter 8.50mm Hole Size Natural Nylon Screw Grommets	25 Pcs.		
9688PK	#8 (4.20mm) Screw Size 10mm Stem Length 16mm Head Diameter 9mm Hole Size Natural Nylon Bumper, Fender & Light Screw Grommets Nissan # 01281-00831	25 Pcs.		
10548PK	#8 (4.20mm) Screw Size 10mm Stem Length 16mm Head Size 9mm Hole Size Natural Nylon Door Trim Panel Screw Grommets Chrysler # 6035401	25 Pcs.		
10668PK	#8 (4.20mm) Screw Size 3/8" Stem Length 5/8" Head Size 1 1/32" Hole Size Tan Nylon With Sealer Tail Light Screw Grommets Chrysler # 6505703AA	15 Pcs.		
12021PK	#8 (4.20mm) Screw Size 13/32" Stem Length 3/8" Head Size Black Nylon Screw Grommets Chrysler # 6033677 Ford # 379830-S, 383356-S	25 Pcs.		
1842PK	#8 (4.20mm) Screw Size 13/32" Stem Length 3/8" Head Size 1/4" Hole Size Natural Nylon Grille Screw Grommets Ford # 379830-S	50 Pcs.		
10553PK	#8 (4.20mm) Screw Size 13/32" Stem Length 1/2" x 2 1/32" Head Size 19/64" x 15/32" Hole Size Black Nylon Door Panel & Fender Shield Screw Grommets Chrysler # 6035821 G.M. # 11517759	25 Pcs.		
10918PK	#8 (4.20mm) Screw Size 11mm Stem Length 7 x 12mm Head Size 7mm Hole Size Black Nylon Inside Fender Screw Grommets V.W. # 811-807-577C	25 Pcs.		
10556PK	#8 (4.20mm) Screw Size 11mm Stem Length 10mm Head Size 6.70mm Hole Size Natural Nylon Door Reveal Screw Grommets Ford # W710362 G.M. # 25647358	25 Pcs.		















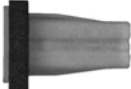

Specialty Nuts

Nuts Nylon

10497PK	#8 (4.20mm) Screw Size 12mm Stem Length 9.50mm Head Size 5.50mm Hole Size Natural Nylon Rear Bumper Screw Grommets Ford # W711412-S300	50 Pcs.		
9681PK	#8 (4.20mm) Screw Size 12mm Stem Length 11.50mm Hole Size Gray Nylon With Sealer Trim Moulding Grommets Hyundai # 14910-05000	10 Pcs.		
11264PK	#8 (4.20mm) Screw Size 12mm Stem Length 20mm Head Diameter 9mm Hole Size Black Nylon Fender Apron Grommets Honda # 90682-SEA-003	25 Pcs.		
15308PK	#8 (4.20mm) Screw Size 13mm Stem Length 11mm Head Diameter 6.50 x 8mm Hole Size Natural Nylon Screw Grommets V.W. # 165-827-592	25 Pcs.		
12478PK	#8 (4.20mm) Screw Size 13mm Stem Length 15mm Head Diameter Black Nylon Fender Apron Screw Grommet V.W. # N908-338-01	15 Pcs.		
10384PK	#8 (4.20mm) Screw Size 13mm Stem Length 23.20mm Square Head Size 10 x 14mm Hole Size White Nylon Cowl Vent Grommets Ford # N807189-S100, N811353-S100	10 Pcs.		
10779PK	#8 (4.20mm) Screw Size 14mm Stem Length 16.70mm Head Size 8 x 10mm Hole Size White Nylon With Sealer Rocker Moulding Screw Grommets Hyundai #87758-37000	25 Pcs.		
10617PK	#8 (4.20mm) Screw Size 14mm Stem Length 20 x 28mm Head Size 7.50 x 12mm Hole Size Natural Nylon Bumper Screw Grommets Nissan # 71144-SR3-A00	25 Pcs.		
11281PK	#8 (4.20mm) Screw Size 15mm Stem Length 15mm Head Diameter 8mm Hole Size Natural Nylon With Sealer Screw Grommets Honda # 90664-SB3-003	10 Pcs.		













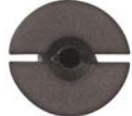

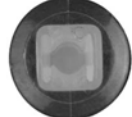
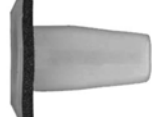

Specialty Nuts

Nuts Nylon

9659PK	#8 (4.20mm) Screw Size 15mm Stem Length 20mm Head Diameter White Nylon Screw Grommets Mazda # GJ6A-58-975	10 Pcs.		
11028PK	#8 (4.20mm) Screw Size 15mm Stem Length 20mm Head Diameter 10mm Hole Size Natural Nylon With Sealer Rocker Moulding Screw Grommets Nissan # 01281-00711	10 Pcs.		
11202PK	#8 (4.20mm) Screw Size 16mm Stem Length 12mm Head Size 7mm Hole Size Natural Nylon With Sealer Bumper Cover Grommets G.M. # 11561847	25 Pcs.		
10658PK	#8 (4.20mm) Screw Size 16mm Stem Length 12mm Head Diameter 7mm Hole Size Natural Nylon With Sealer Door Panel Screw Grommets Honda # 90370-SG0-003, 91626-SH3-003	15 Pcs.		
12725PK	#8 (4.20mm) Screw Size 16mm Stem Length 12mm Head Size 10mm Hole Size Black Nylon Screw Grommets Mitsubishi # MB029111 Toyota # 90189-04008, 90467-12096, 94841130	15 Pcs.		
10772PK	#8 (4.20mm) Screw Size 16mm Stem Length 17 x 25mm Head Size 8 x 10mm Hole Size Yellow Nylon With Sealer Trim Screw Grommets Hyundai #87759-27000	25 Pcs.		
13318PK	#8 (4.20mm) Screw Size 16mm Stem Length 18mm Flange Diameter Natural Nylon Trim Screw Grommets Mercedes # 000-988-86-25	25 Pcs.		
1572PK	#8 (4.20mm) Screw Size 17mm Stem Length 16mm Head Diameter 8mm Hole Size Natural Nylon Screw Grommets Honda # 90661-SC7-0030, 90661-SC7-003 Mazda # H001-50-841, Mitsubishi # MS-480012 Nissan # 01651-00481, 74798-S90000, 01281-00231 Toyota # 90189-06042	25 Pcs.		
11994PK	#8 (4.20mm) Screw Size 18mm Stem Length 11.50mm Head Size Black Nylon Bumper & Tail Light Screw Grommets Ford # W708580-S300	25 Pcs.		

















Specialty Nuts

Nuts Nylon

10552PK	#8 (4.20mm) Screw Size 18mm Stem Length 13 x 22mm Head Diameter 6 x 16.50mm Hole Size Natural Nylon With Sealer Back Glass Moulding & Inter. Trim Ford # W705590-S300, W710459-S300 G.M. # 25649667	15 Pcs.		
10943PK	#8 (4.20mm) Screw Size 18mm Stem Length 16mm Head Diameter 8mm Hole Size Black Nylon Interior Frame Grommets V.W. # 4A0-857-610	25 Pcs.		
10406PK	#8 (4.20mm) Screw Size 18mm Stem Length 16mm Head Diameter 9mm Hole Size Natural Nylon With Sealer Trunk Trim Screw Grommets Mitsubishi # MU480034	15 Pcs.		
10938PK	#8 (4.20mm) Screw Size 18.50mm Stem Length 16mm Head Diameter 8.50mm Hole Size Natural Nylon Screw Grommets V.W. # 321-813-998A	25 Pcs.		
10524PK	#8 (4.20mm) Screw Size 20mm Stem Length 15mm Head Size 8.50mm Hole Size Natural Nylon With Sealer Door Trim Screw Grommets Chrysler # 6507009-AA	25 Pcs.		
10926PK	#8 (4.20mm) Screw Size 20mm Stem Length 15mm Head Diameter 9mm Hole Size Black Nylon Bumper & Fender Screw Grommets V.W. # N908-214-01	15 Pcs.		
12051PK	#8 (4.20mm) Screw Size 20mm Stem Length 16mm Head Diameter Natural Nylon With Sealer Screw Grommets Nissan # 01281-00691	15 Pcs.		
9662PK	#8 (4.20mm) Screw Size 21mm Stem Length 18mm Head Size 8.50mm Hole Size Natural Nylon With Sealer Bumper Screw Grommets Hyundai # 86910-21010	15 Pcs.		
2117PK	#8 (4.20mm) Screw Size 23mm Stem Length 10mm Head Size 7mm Hole Size Natural Nylon Screw Grommets Ford # N804765-S	50 Pcs.		



















Specialty Nuts

Nuts Nylon

9323PK	#10 (4.80mm) Screw Size 7mm Stem Length 13mm Head Diameter 8mm Hole Size Natural Nylon Screw Grommets Mitsubishi # MB383455 Nissan # 01281-00022, 72774-01F00	50 Pcs.		
1610PK	#10 (4.80mm) Screw Size 7mm Stem Length 14mm Head Size 9mm Hole Size Black Nylon Screw Grommets Toyota # 90189-06018	25 Pcs.		
13324PK	#10 (4.80mm) Screw Size 7mm Stem Length 14 x 14mm Head Size 9.50 x 8.50mm Hole Size Yellow Nylon Screw Grommets Subaru # 66117-9000, 90930-0007	25 Pcs.		
10978PK	#10 (4.80mm) Screw Size 7.30mm Stem Length 17mm Head Size 1.50 x 7mm Hole Size Black Nylon Bumper Grommets Honda # 90107-SX0-003	15 Pcs.		
14992PK	#10 (4.80mm) Screw Size 7.50mm Stem Length 11.50mm Head Size 8 x 8mm Hole Size Natural Nylon Spalsh Shield Grommets Mazda # 9991-00-501	25 Pcs.		
15829PK	#10 (4.8mm) Screw Size 8mm Stem Length 13mm Head Diameter 8mm Hole Size White Nylon License Plate Grommets G.M. # 3783006	50 Pcs.		
1614PK	#10 (4.80mm) Screw Size 8mm Stem Length 13mm Head Size 8.50mm Hole Size Natural Nylon Screw Grommets Honda # 75521-611-0000, 91619-SA5-003 Mazda # 9991-00-601 Nissan # 96706-P0105 Toyota # 90189-06010	25 Pcs.		
10771PK	#10 (4.80mm) Screw Size 8mm Stem Length 14.70mm Head Diameter 8.50mm Hole Size Yellow Nylon Interior Trim Grommets Hyundai # 81385-38000	25 Pcs.		



















Specialty Nuts

Nuts Nylon

1296PK	#10 (4.80mm) Screw Size 8mm Stem Length 16.50mm Head Size 8 x 8.50mm Hole Size Natural Nylon Screw Grommets Honda # 90662-671-0030, 90662-671-003, 90662-SB-003 Mazda # 9991-00-503 Nissan # 68425-H5000, 62698-V7000	25 Pcs.		
15343PK	#10 (4.80mm) Screw Size 8.70mm Stem Length 17 x 17mm Head Size White Nylon Arm Rest Screw Grommets Subaru # 94079AA000	15 Pcs.		
10549PK	#10 (4.80mm) Screw Size 9.50mm Stem Length 14 x 20mm Head Size White Nylon Cowl Vent Grommets Chrysler # 4860375-AB	50 Pcs.		
10659PK	#10 (4.80mm) Screw Size 10mm Stem Length 16mm Head Diameter 9mm Hole Size Natural Nylon Screw Grommets Nissan # 01281-00111 Toyota # 90189-06006	25 Pcs.		
12914PK	#10 (4.80mm) Screw Size 10mm Stem Length 16mm Head Size Black Nylon Wheel Well Moulding Screw Grommets Honda # 90107-S10-003	25 Pcs.		
10796PK	#10 (4.80mm) Screw Size 11mm Stem Length 12mm Head Size 9mm Hole Size White Nylon Bumper & Fender Screw Grommets Hyundai # 14913-05010	25 Pcs.		
17945PK	#10 (4.80mm) Screw Size 11mm Stem Length 9.50mm Head Size Natural Nylon Lower Door & Handle Interior Trim Grommets G.M. # 90230846, 94515248	25 Pcs.		
1560PK	#10 (4.80mm) Screw Size 11mm Stem Length 12mm Head Size 8 x 9mm Hole Size Natural Nylon Grille Screw Grommets G.M. # 94841764 Mitsubishi # MS480002, MS480009 Toyota # 90189-05013	50 Pcs.		
17833PK	#10 (4.80mm) Screw Size 11mm Stem Length 20mm Head Diameter 11.50 x 7.50mm Hole Size Black Nylon Radiator Grille Screw Grommets	25 Pcs.		













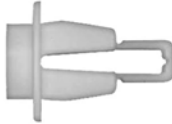



Specialty Nuts

Nuts Nylon

17908PK	#10 (4.80mm) Screw Size 11mm Stem Length 20mm Head Diameter 11.50 x 7.50mm Hole Size Red Nylon Radiator Grille Screw Grommets Ford # W702438-S300	25 Pcs.		
10777PK	#10 (4.80mm) Screw Size 12mm Stem Length 16mm Head Diameter 8.50mm Hole Size Black Nylon Fender Apron Screw Grommets Hyundai # 86848-22000, 86848-C8000	25 Pcs.		
12585PK	#10 (4.80mm) Screw Size 12.50mm Stem Length 12mm Head Diameter Black Nylon Screw Grommets Audi # 867-809-966 V.W. # 811-807-557-C	25 Pcs.		
10620PK	#10 (4.80mm) Screw Size 13mm Stem Length 16mm Head Diameter 8.50mm Hole Size Natural Nylon With Sealer Body Moulding Screw Grommets Nissan # 01281-00601	15 Pcs.		
10981PK	#10 (4.80mm) Screw Size 14mm Stem Length 14mm Head Size 8.50mm Hole Size Black Nylon Rear Bumper Screw Grommets Honda # 90682-SDA-A01	15 Pcs.		
10426PK	#10 (4.80mm) Screw Size 14mm Stem Length 25 x 26mm Head Size 9.50 x 23mm Hole Size Black Nylon Headlight To Grille Spacer Bracket Grommets Honda # 91635-SM4-003	10 Pcs.		
13322PK	#10 (4.80mm) Screw Size 15mm Stem Length 12mm Head Diameter 6.50 x 8mm Hole Size Black Nylon Screw Grommets V.W. # 6N0-809-966A	25 Pcs.		
11156PK	#10 (4.80mm) Screw Size 16mm Stem Length 20mm Flange Diameter 8.50mm Hole Size White Nylon With Sealer Bumper Grommets Nissan # 63846-5V000	25 Pcs.		
15147PK	#10 (4.80mm) Screw Size 17mm Stem Length 12 x 19mm Head Size 8 x 15mm Hole Size White Nylon Screw Grommets Honda # 90683-693-0000 Nissan # 78856-R4301	25 Pcs.		



















Specialty Nuts

Nuts Nylon

1576PK	#10 (4.80mm) Screw Size 17mm Stem Length 18mm Head Diameter 8.50mm Hole Size Natural Nylon Screw Grommets Mitsubishi # MB-098145 Nissan # 01281-00023, 01281-00231 Toyota # 90189-06001, 96706-U0100	25 Pcs.		
11036PK	#10 (4.80mm) Screw Size 17.50mm Stem Length 16mm Head Diameter 10mm Hole Size Natural Nylon Front Bumper Grommets Nissan # 01281-01081	15 Pcs.		
12611PK	#10 (4.80mm) Screw Size 18mm Stem Length 9.50 x 8.50mm Hole Size White Nylon With Sealer Bumper Cover Screw Nuts Hyundai # 86625-3S000	25 Pcs.		
10942PK	#10 (4.80mm) Screw Size 20mm Stem Length 16mm Head Diameter 8mm Hole Size Black Nylon Door Panel Screw Grommets V.W. # 357-827-998	15 Pcs.		
11229PK	#10 (4.80mm) Screw Size 24mm Stem Length 16mm Head Diameter 10mm Hole Size White Nylon With Sealer Front Bumper Screw Grommets Ford # W708319-S300	25 Pcs.		
10775PK	#12 (5.50mm) Screw Size 8.50mm Stem Length 13mm Head Size 9mm Hole Size White Nylon Rocker Moulding Screw Grommets Hyundai # 87756-35000	25 Pcs.		
18102PK	#12 (5.50mm) Screw Size 9mm Stem Length 10mm Top Head Size Yellow Nylon Front & Rear Bumper Screw Grommets Nissan # 85099-1MA0A	25 Pcs.		
10745PK	#12 (5.50-6mm) Screw Size 9mm Stem Length 17 x 30mm Head Size Black Nylon Front Bumper Screw Grommets Toyota # 52535-50060, 52535-0E010	5 Pcs.		
10794PK	#12 (5.50mm) Screw Size 10mm Stem Length 14 x 16mm Head Size 9 x 11mm Hole Size White Nylon Front Bumper Screw Grommets Toyota # 90189-06193, 90189-06237	25 Pcs.		

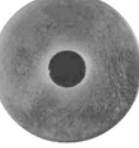



















Specialty Nuts

Nuts Nylon

12073PK	#12 (5.50mm) Screw Size 10mm Stem Length 17mm Head Diameter 9mm Square Hole Size Black Nylon Rocker & Floor Screw Grommets Toyota # 90189-06211	25 Pcs.		
9503PK	#12 (5.50mm) Screw Size 11mm Stem Length 15.60mm Flange Size 9mm Hole Size Black Nylon License Plate Nuts Chrysler # 6032516	25 Pcs.		
10551PK	#12 (5.50mm) Screw Size 9/16" Stem Length 5/8 x 3/4" Head Size 11/32 x 1/2" Hole Size Natural Nylon Door Handle Screw Grommets G.M. # 11517873	15 Pcs.		
15839PK	#12 (5.50mm) Screw Size 15mm Stem Length 16mm Head Diameter 10mm Hole Size Natural Nylon Back Panel Attachment Grommets Ford # W700566-S300	25 Pcs.		
18164PK	#12 (5.50mm) Screw Size 17mm Stem Length 20mm Flange Diameter 9mm Hole Size Black Nylon Fender Liner Screw Grommets Toyota # 90189-06236	25 Pcs.		
10988PK	#12 (5.50mm) Screw Size 18mm Stem Length 16mm Head Diameter 9mm Hole Size Black Nylon Fender Liner Screw Grommets Toyota # 90189-06214	15 Pcs.		
13323PK	#12 (5.50mm) Screw Size 18mm Stem Length 20mm Head Diameter White Nylon With Sealer Screw Grommets Subaru # 91084AA010	15 Pcs.		
11389PK	#12 (5.50mm) Screw Size 18mm Stem Length 20mm Head Diameter 9mm Hole Size Black Nylon Fender & Hood Screw Grommets Toyota # 90189-06065	15 Pcs.		
9912PK	#12 (5.50mm) Screw Size 19mm Stem Length 16mm Head Diameter 8mm Square Hole Size Black Nylon Front & Rear Wheel Fender Liner Screw Grommets Toyota # 90189-06028	15 Pcs.		















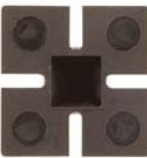

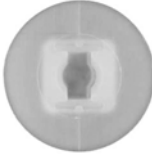
Specialty Nuts

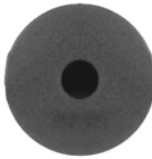
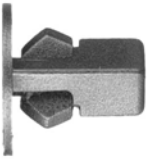
Nuts Nylon

9136PK	#12 (5.50mm) Screw Size 13/16" Stem Length 1/2" Head Size 3/8" Square Hole Natural Nylon Windshield Washer Reservoir Mounting Screw Grommets Ford # F5RZ-17K657-A	25 Pcs.			
9913PK	#12 (5.50mm) Screw Size 22mm Stem Length 20mm Head Diameter 8mm Square Hole Size Black Nylon Front & Rear Wheel Fender Liner Screw Grommets Toyota # 90189-06157	15 Pcs.			
9481PK	#12 (5.50mm) Screw Size 24mm Stem Length 22 x 18mm Head Size White Nylon With Sealer Front Bumper Screw Grommets Lexus # 52197-30040	15 Pcs.			
9101PK	#14 (6.30mm) Screw Size 8mm Stem Length 13 x 15mm Head Size 8.50 x 10.50mm Hole Size Natural Nylon Screw Grommets Honda # 90656-671-6310M1	50 Pcs.			
9494PK	#14 (6.30mm) Screw Size 5/16" Stem Length 5/8 x 3/4" Head Size 3/8" Hole Size Natural Nylon License Plate Nuts Ford # 380707-S	50 Pcs.			
9872PK	#14 (6.30mm) Screw Size 8mm Stem Length 14.30mm Head Diameter 8.50mm Hole Size Natural Nylon License Plate Screw Grommets G.M. # 380370	50 Pcs.			
17927PK	#14 (6.30mm) Screw Size 8mm Stem Length 16mm Head Size Black Nylon With Sealer Bumper, License Plate & Tail Light Screw Grommets G.M. # 25832258	10 Pcs.			
1228PK	#14 (6.30mm) Screw Size 5/16" Stem Length 5/8" Head Size 13/32" Hole Size White Plastic License Plate Nuts Chrysler # 6023925 G.M. # 3907444	50 Pcs.			
10461PK	#14 (6.30mm) Screw Size 8mm Stem Length 16mm Head Size 9.50 x 10mm Hole Size Black Nylon With Sealer License Plate Grommets Ford # N811478-S100	15 Pcs.			

















Specialty Nuts

Nuts Nylon

9678PK	#14 (6.30mm) Screw Size 10mm Stem Length 12 x 16mm Head Size Gray Nylon Wheel Well Opening Screw Grommets Use With # 9679 Nissan # 76848-JG00A	15 Pcs.		
12664PK	#14 (6.30mm) Screw Size 11mm Stem Length 15mm Head Diameter 9.50mm Hole Size Natural Nylon Screw Grommets G.M. # 4755299	50 Pcs.		
10525PK	#14 (6.30mm) Screw Size 14mm Stem Length 20mm Head Size 8mm Hole Size Black Nylon License Plate Grommets G.M. # 22546934	50 Pcs.		
11020PK	#14 (6.30mm) Screw Size 16mm Stem Length 20mm Head Diameter 10mm Hole Size Natural Nylon With Sealer Rocker Panel Screw Grommets Nissan # 01281-00331	25 Pcs.		
1605PK	#14 (6.30mm) Screw Size 17mm Stem Length 20mm Head Diameter 8mm Square Hole Size Black Nylon Screw Grommets Toyota # 90189-06013, 96706-W100	25 Pcs.		
10550PK	#14 (6.30mm) Screw Size 17mm Stem Length 24mm Head Size 15mm Hole Size Black Nylon With Sealer Light Housing Screw Grommets G.M. # 15745990, 15289020, 11609535	15 Pcs.		
13437PK	#14 (6.30mm) Screw Size 19mm Stem Length 16 x 18mm Head Size Black Nylon Bumper Side Bracket Screw Grommets Toyota # 52197-22020	15 Pcs.		
10119PK	#14 (6.30mm) Screw Size 3/8" Hole Size Natural Nylon License Plate Screw Grommets Chrysler # 6027958	10 Pcs.		
11391PK	#14 (6.30mm) Screw Size 23mm Stem Length 15 x 18mm Head Size White Nylon With Sealer Rear Bumper Screw Grommets G.M. # 25704358	10 Pcs.		













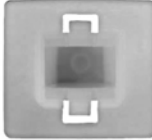

Specialty Nuts

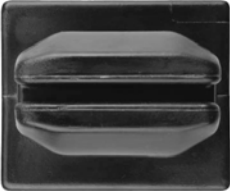
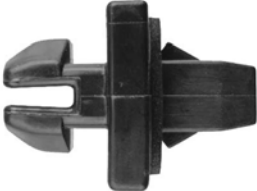
Nuts Nylon

1608PK	#14 (6.30-1.81mm) Screw Size 16mm Stem Length 18mm Head Diameter 8mm Hole Size White Nylon Screw Grommets Toyota # 90189-06005	50 Pcs.		
13440PK	#14 (6.30-1.81mm) Screw Size 16mm Stem Length 15 x 19mm Head Size Brown Nylon With Sealer Screw Grommets Nissan # 26557-2U001	15 Pcs.		
9079PK	23/64" (9mm) Hole Size 15mm Stem Length 18mm Head Diameter White Nylon Front Fender Screw Grommets Toyota # 90189-06114	15 Pcs.		
15341PK	25/64" (10mm) Hole Size 19.50mm Stem Length 25 x 33mm Head Size Black Nylon With Sealer Bumper Cover Grommets Subaru # 99011FC000NN	15 Pcs.		
10055PK	15/32" (12mm) Hole Size 12mm Stem Length 16mm Head Size Black Nylon Tail Light Grommets Chrysler # 6504072	25 Pcs.		
13248PK	33/64" (13mm) Hole Size 21mm Stem Length 24mm Head Diameter Black Nylon Bumper Cover Grommet Mitsubishi # MB271999	10 Pcs.		
13299PK	5mm Stud Diameter 10mm Hex Size 16mm Flange Diameter Black Nylon Flange Nuts BMW # 16-13-1-176-747 Mercedes # 003-990-02-51	25 Pcs.		
12062PK	11mm Head Size 9mm Stem Length 8mm Hole Size White Nylon Front & Rear Bumper Cover Grommets Kia # 86699-2D000	25 Pcs.		





















Specialty Nuts

Nuts Nylon

13083PK	16mm Head Diameter 12mm Stem Length 8mm Hole Size Black Nylon Screw Grommets Nissan # 76881-JG00A	15 Pcs.		
11397PK	18mm Top Head Diameter 9.50mm Stem Length 10mm Hole Size Natural Nylon Bumper Grommets Honda # 91509-SM4-000	10 Pcs.		
10999PK	18 x 20mm Head Size 19mm Stem Length 8 x 11mm Hole Size White Nylon Bumper Grommets Honda # 90106-SW3-003	10 Pcs.		
12075PK	25 x 30mm Head Size 15mm Stem Length 35mm Overall Length Black Nylon With Sealer Bumper Cover Grommet Kia # 86591-25000	5 Pcs.		
10971PK	17mm Overall Height 30mm Overall Length Black Nylon Bumper Filler Clips Toyota # 53935-35020	10 Pcs.		
11129PK	22mm Overall Length Natural Nylon Front Bumper Grommets Nissan # 01281-01321	50 Pcs.		
10977PK	5-.80mm Screw Size 8mm Stem Length 13mm Head Size 8mm Hole Size Natural Nylon Headlight Adjusting Grommets Honda # 90676-SA7-003, 90682-SB0-003	25 Pcs.		
9679PK	8 x 17mm Head Size 12mm Stem Length Yellow Nylon Wheel Well Opening Moulding Clips Use With # 9678 Nissan # 76847-JG00A	25 Pcs.		

















Specialty Nuts

Retainers Grommets

15716PK	9/32" (7mm) Hole Size 5mm Stem Length 9mm Head Diameter White Nylon Moulding Grommet Mercedes # 000-987-10-81	50 Pcs.		
13333PK	9/32" (7mm) Stud Size 16mm Stem Length 16mm Head Diameter 8.50mm Hole Size Natural Nylon Tubular Nuts BMW # 51-44-7-780-135 Mercedes # 108-988-00-27	25 Pcs.		
10498PK	8.75 x 15.75mm Hole Size 17.50mm Stem Length 13 x 20mm Head Size Blue Nylon With Sealer Headlight Screw Grommets G.M. # 11561382, 11610198	10 Pcs.		
10973PK	23/64" (9mm) Hole Size 6mm Stem Length 13mm Head Diameter Black Nylon Inserts Grommets V.W. # 357-853-586D	25 Pcs.		
1404PK	23/64" (9mm) Hole Size 6.70mm Stem Length 10.50mm Head Diameter 4.50mm Pin Diameter Red Nylon Moulding Grommets Mercedes # 000-988-15-81	50 Pcs.		
12477PK	23/64" (9mm) Hole Size 12mm Stem Length 11.50mm Head Diameter White Nylon Moulding Insert Grommets Mercedes # 001-988-76-81	25 Pcs.		
12626PK	23/64" (9mm) Hole Size 14mm Stem Length 4.50mm Inside Diameter Red Nylon Tubular Nuts Mercedes # 001-988-20-81	50 Pcs.		
12024PK	10 x 11mm Hole Size 10mm Stem Length 13 x 17mm Head Size Black Nylon Tail Light Grommets Ford # W711079-S300	25 Pcs.		
9355PK	25/64" (10mm) Hole Size 9mm Stem Length 13mm Head Diameter Black Nylon Grille & Side Marker Light Screw Grommets Ford # N807994-S, N811169S, W704740-S300, W705550S300	50 Pcs.		
10781PK	25/64" (10mm) Hole Size 8mm Stem Length 15mm Head Diameter Natural Nylon Headlight Assembly Grommets Hyundai # XG300/350, Kia # 92351-37000	25 Pcs.		







Specialty Nuts

Retainers Grommets





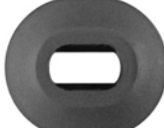





15816PK	25/64" (10mm) Hole Size 15mm Stem Length 18mm Head Diameter White Nylon With Sealer Tail Light Grommets G.M. # 22884291	10 Pcs.		
10526PK	7/16" (11mm) Hole Size 17mm Stem Length 15mm Head Diameter Black Nylon With Sealer Tail Light Grommets G.M. # 11561655, 11609862, 11610705	5 Pcs.		
13368PK	7/16" (11mm) Hole Size 16mm Stem Length 16mm Head Diameter White Nylon Fog Light Grommets G.M. # 11570830	15 Pcs.		
9712PK	7/16" (11mm) Hole Size 9mm Stem Length 13mm Head Diameter White Nylon Park & Turn Signal Grommets Ford # N811169-S, W705550-S300 G.M. # 10423331 Toyota # 90075-10801, 90189-06111	50 Pcs.		
9418PK	11.50 x 15.50mm Hole Size 26mm Length 22mm Width Black Nylon Grille Grommet Retainers Nissan # 62380-U7400	10 Pcs.		
15017PK	11.50 x 18mm Hole Size 10mm Stem Length 17 x 23mm Head Size Black Nylon Headlight Assembly Grommets Nissan # 76848-8J010	10 Pcs.		
11127PK	12mm Hole Size 11mm Stem Length 19mm Head Diameter Black Nylon Tail Light Assembly Grommets Chrysler # 68084593-AA	25 Pcs.		
10541PK	14 x 26mm Hole Size 20 x 31mm Head Receives 10mm Ball Stud Black Nylon Tail Light Grommets Chrysler # 55156879-AB	25 Pcs.		

Specialty Nuts

Retainers Grommets



















11162PK	19/32" (15mm) Hole Size 21mm Stem Length 21mm Stem Length .9mm Thick Panel Black Nylon With Sealer G.M. # 11561987	15 Pcs.		
10554PK	9 x 16mm Hole Size 17mm Stem Length 13 x 20mm Head Size Black Nylon Rear Light Housing Screw Grommets Chrysler # 5113360-AA G.M. # 15284612, 11609536, 15745991	15 Pcs.		
11126PK	9.50 x 21.50mm Hole Size 18mm Stem Length 18.50 x 21.50mm Head Size Black Nylon Headlight & Tail Light Grommets Ford # F50Y-14603-A	25 Pcs.		

Retainers Grommets & Pin

12093PK	9/32" (7mm) Hole Size 7mm Stem Length 14mm Flange Diameter 3mm Pin Diameter Natural Nylon Cowl Grommets Use With #12094 Subaru # 91486-KJ000	25 Pcs.		
12094PK	3mm Pin Diameter 13mm Stem Length 16 x 18mm Head Size Black Nylon Cowl Retainers Use With #12093 Subaru # 91486-KJ010	25 Pcs.		
10959PK	5/16" (8mm) Hole Size 11mm Stem Length 13.20mm Head Diameter 6mm Pin Diameter Natural Nylon Door Trim Panel Grommets Use With #10958 V.W. # 3B0-867-334	50 Pcs.		
10958PK	6mm Pin Diameter 12.50mm Top Head Diameter 16mm Stem Length Natural Nylon Door Trim Panel Retainers Use With #10959 V.W. # 3B0-867-333	25 Pcs.		
12376PK	23/64" (9mm) Hole Size 16mm Stem Length 18mm Head Diameter White Nylon Cowl Vent Grommets Use With # 12375 Toyota # 90467-10152	10 Pcs.		













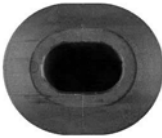

Specialty Nuts

Retainers Grommets & Pin

12375PK	23/64" (9mm) Pin Size 17mm Stem Length 16mm Head Diameter Black Nylon Cowl Vent Pin Retainers Use With # 12376 Toyota # 90467-07126	10 Pcs.		
10467PK	23/64" (9mm) Hole Size 12mm Stem Length 19mm Head Diameter 3mm Pin Diameter White Nylon Door Panel Grommets Use With #10466 Chrysler # 6506655AA	25 Pcs.		
11169PK	23/64" (9mm) Hole Size 12mm Stem Length 19mm Head Diameter 3mm Pin Diameter Green Nylon Door Panel Grommets Use With #10466 Chrysler # 4784018-AA	25 Pcs.		
10466PK	3mm Pin Diameter 20mm Stem Length 13mm Top Head Diameter White Nylon Door Trim Panel Pin Retainers Use With #10467 & #11169	25 Pcs.		
18145PK	3/8" (9.50mm) Hole Size 21mm Stem Length Natural Rubber Rear Bumper Cover Grommets Use With # 17832 Ford # W708045-S300	25 Pcs.		
18255PK	3/8" (9.50mm) Hole Size 21mm Stem Length Black Rubber Rear Bumper Cover Grommets Use With # 17832 Ford # W708045-S300	25 Pcs.		
17832PK	9/32" (7mm) Hole Size 25mm Stem Length 21mm Head Diameter Black Nylon Rear Bumper Cover Retainers Use With # 18145 Ford # W708035-S300	25 Pcs.		
10618PK	8 x 9mm Hole Size 13mm Stem Length 13mm Head Size 4.10mm Pin Diameter White Nylon With Sealer Cowl Vent Screw Grommets Use With #10678 Nissan # 80874-0P00	15 Pcs.		
10678PK	4.10mm Pin Diameter 15mm Stem Length 10mm Head Diameter Black Nylon Cowl Screen Pin Retainers Use With #10618 Nissan # 66820-88E00	25 Pcs.		



















Specialty Nuts

Retainers Grommets & Pin

13255PK	6mm Stud Size 20mm Overall Width 16mm Overall Height Black Nylon Skid Shield Grommets Use With 12589 V.W. # 4A0805163	25 Pcs.		
12589PK	6mm Stud Size 22mm Stem Length 25mm Head Diameter Black Nylon Skid Plate Screws Use With 13255 V.W. # 4A0-805-121A	25 Pcs.		
11189PK	9.50 x 13.50mm Hole Size 18mm Stem Length 17.50 x 21.50mm Head Size 5mm Pin Diameter Black Nylon Fascia Grommets Use With #11190 G.M. # 22603044	15 Pcs.		
11190PK	5mm Pin Diameter 19.70mm Pin Length 3.30mm Panel Range Black Nylon Front Bumper Fascia Hinged Pin Retainers Use With #11189 G.M. 22615352, 11588782, 22603043	15 Pcs.		
11984PK	5.80mm Stud Size 13mm Hex Size 25mm Washer Diameter Black Nylon Grille Retainer Nuts Use With # 11983 Camaro 2010 Cadillac SRS & SRX G.M. # 11610748	25 Pcs.		
11983PK	5.80mm Stem Diameter 25.50mm Stem Length 25mm Head Diameter Black Nylon Slotted Grille Retainers Use With # 11984 Camaro 2010 Cadillac SRS & SRX G.M. # 11610747	25 Pcs.		
18230PK	13.50 x 7.60mm Hole Size 16mm Stem Length 22 x 14mm Head Size Dark Gray Engine Cover Grommets Honda # 91548-TZ5-A02	25 Pcs.		
18229PK	17mm Stem Length 22mm Overall Length 13mm Top Head Diameter Black Nylon Engine Cover Retainers Honda # 91547-TZ5-A02	50 Pcs.		

Specialty Nuts

Nuts Miscellaneous



12273PK	#6 (3.50mm) Screw Size 10mm Width 18mm Overall Height Zinc Finish Bumper & Grille Fasteners Chrysler # 4806226-AA, 68004187-AA Ford # W710754-S439 G.M. # 11562364	15 Pcs.		
9199PK	#8 (4.20mm) Screw Size Zinc Finish Radiator Grille Nuts Ford # N802865-S100 G.M. # 15686142, 11561448	25 Pcs.		
11258PK	#8 (4.20mm) Screw Size 8.65mm Hole Size Zinc Finish Fender Bracket Push In Nuts G.M. # 11518531	15 Pcs.		
12983PK	#8 (4.20mm) Screw Size 6 x 16mm Head Size 7mm Overall Height Magni-565 Finish Front Bumper Nuts G.M. # 11609952	25 Pcs.		
11032PK	#8 (4.20mm) Screw Size .70mm-2.30mm Panel Range 8.70mm Hole Size Blue Finish Mid Panel Nuts Chrysler # 6509432AA Ford # W716529-S900 G.M. # 1570654	25 Pcs.		
10733PK	#8 (4.20mm) Screw Size .70mm-1.50mm Panel Range 8.70mm Hole Size Gray Finish With Sealer Tail Light Quarter Panel Nuts Ford # W714171-S439 G.M. # 11569711	25 Pcs.		
18096PK	#8 (4.20mm) Screw Size 11.70mm Width 16.50mm Length Gray Finish With Sealer Specialty Nuts Ford # W713617-S439	15 Pcs.		
11034PK	#8 (4.20mm) Screw Size 9 x 11mm Hole Size Black Finish Dash Panel Nuts Ford # N803685S G.M. # 14083173, 17997722, 17988488	25 Pcs.		
15864PK	#8 (4.20-1.41mm) Screw Size 1.40 - 5mm Panel Range 10.90 x 13mm Hole Size Green Metallic Finish Bracket Retainer Nuts G.M. # 11548673	15 Pcs.		

Specialty Nuts

Nuts Miscellaneous



18094PK 6-1.00 Screw Size
.70mm-3.80mm Panel Range
9.25 x 13.75mm Hole Size
Zinc Finish
Rear Bumper Bracket Nuts
G.M. # 11547582

25 Pcs.



10143PK 17/32" (13.50mm) Hole Size
11mm Overall Length
Zinc Finish
Headlamp Assembly Nuts
G.M. # 11570015

15 Pcs.



13423PK 6-1.00 Screw Size
11mm Overall Height
Zinc Organic
Radiator Grille & Front
End Panel Nuts
G.M. # 11518937

10 Pcs.



12849PK 6-1.00mm Thread Size
Black Nylon
Metal Insert Threaded
Hood Adjustment Nuts
Ford 1989 - On

10 Pcs.



9709PK 5/16"-18 Thread Size
Plain Finish
Slab Weld Nuts

25 Pcs.

18099PK 23/64" (9mm) Hole Size
9mm Overall Height
30mm Head Diameter
Gray Nylon
Sound Insulation Grommets
BMW # 51-48-8-126-849



25 Pcs.

Nutserts Hex Type Automotive



12439PK 5-.80mm Thread Size
10mm Hex Size
10mm Flange Diameter
.70mm-1.50mm Grip Range
Silver and Wax Finish
Hex Type Steel Nutserts
Chrysler # 6503812, 6504601

15 Pcs.













12444PK 6-1.00mm Thread Size
8mm Hex Size
12mm Flange Diameter
.65mm-2mm Grip Range
Zinc Finish W/Sealer
Hex Type Steel Nutserts
Ford # N803763-S100
G.M. # 15685099

15 Pcs.

Specialty Nuts

Nutserts Hex Type Automotive

12443PK	6-1.00mm Thread Size 9.50mm Hex Size 13mm Flange Diameter .50mm-4.20mm Grip Range Yellow Zinc W/Sealer Hex Type Steel Nutserts Ford # W706172-S309, W708384-S309	15 Pcs.		
12440PK	6-1.00mm Thread Size 9.50mm Hex Size 13mm Flange Diameter .70mm-4mm Grip Range Front Core Support Zinc Hex Type Steel Nutserts G.M. # 11519952	15 Pcs.		
12445PK	6-1.00mm Thread Size 9.50mm Hex Size 17mm Flange Diameter .70mm-3.20mm Grip Range Zinc Finish Hex Type Steel Nutserts Chrysler # 6506104AA	10 Pcs.		
12446PK	6-1.00mm Thread Size 9.50mm Hex Size 17mm Flange Diameter .70mm-3.17mm Grip Range Zinc Finish Hex Type Steel Nutserts Chrysler # 6509106-AA	15 Pcs.		
12441PK	8-1.25mm Thread Size 12.50mm Hex Size 17mm Flange Diameter .70mm-4mm Grip Range Zinc Finish Hex Type Steel Nutserts G.M. # 11519960	15 Pcs.		
11406PK	8-1.25mm Thread Size 12.70mm Hex Size 22mm Flange Diameter .70mm-3.80mm Grip Range Zinc Finish Hex Type Steel Nutserts Ford # W708513-S437	15 Pcs.		

Specialty Nuts

Nutserts Thin Sheet

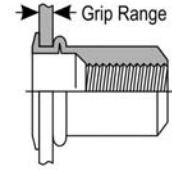
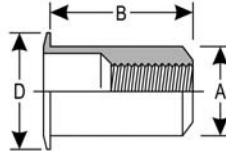

Part #	Thread Size	Grip Range	A	B	D	Drill Size	Qty.
13130PK	6-32	.020 - .080"	.249"	.385"	.295"	1/4"	50 Pcs.
13131PK	8-32	.020 - .080"	.249"	.385"	.295"	1/4"	50 Pcs.
13132PK	10-24	.020 - .130"	.280"	.440"	.320"	9/32"	50 Pcs.
13133PK	10-32	.020 - .130"	.280"	.440"	.320"	9/32"	50 Pcs.
13134PK	1/4"-20	.030 - .165"	.347"	.580"	.425"	3/8"	25 Pcs.
13136PK	5/16"-18	.030 - .165"	.499"	.690"	.560"	1/2"	25 Pcs.
13138PK	3/8"-16	.040 - .200"	.499"	.690"	.560"	1/2"	15 Pcs.
13140PK	4-.70mm	.50 - 2.00mm	6.32mm	9.78mm	7.49mm	6.40mm	50 Pcs.
13141PK	5-.80mm	.50 - 3.30mm	7.11mm	11.18mm	8.13mm	7.20mm	50 Pcs.
13142PK	6-1.00mm	.75 - 4.20mm	9.50mm	14.73mm	10.80mm	9.60mm	25 Pcs.
13143PK	8-1.25mm	1.02 - 5.10mm	12.67mm	17.53mm	14.22mm	12.70mm	25 Pcs.
13144PK	10-1.50mm	1.02 - 5.10mm	12.67mm	17.53mm	14.22mm	12.70mm	15 Pcs.

Nutserts Round Type

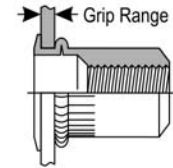
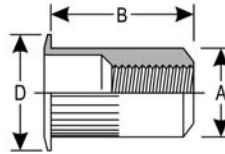

Part #	Thread Size	Grip Range	A	B	D	Drill Size	Qty.
13411PK	3-.50mm	.50 - 2.00mm	4.90mm	9.02mm	7.85mm	5mm	25 Pcs. NEW
12674PK	4-.70mm	.50 - 2.00mm	6.73mm	10.67mm	9.91mm	6.75mm	25 Pcs.
12676PK	5-.80mm	.50 - 3.30mm	7.52mm	12.07mm	10.54mm	7.60mm	25 Pcs.
12678PK	6-1.00mm	.70 - 4.20mm	9.91mm	14.73mm	12.70mm	10mm	25 Pcs.
12680PK	8-1.25mm	.70 - 3.80mm	13.46mm	17.53mm	17.40mm	13.50mm	10 Pcs.
12682PK	10-1.50mm	.70 - 3.80mm	13.46mm	17.53mm	17.40mm	13.50mm	10 Pcs.
12694PK	6-32	.020 - .080"	.265"	.420"	.390"	17/64"	25 Pcs.
12696PK	8-32	.020 - .080"	.265"	.420"	.390"	17/64"	25 Pcs.
12698PK	10-24	.020 - .130"	.296"	.475"	.415"	19/64"	25 Pcs.
12699PK	10-32	.020 - .130"	.296"	.475"	.415"	25/64"	25 Pcs.
12700PK	1/4"-20	.027 - .165"	.390"	.580"	.500"	25/64"	25 Pcs.
12702PK	5/16"-18	.027 - .150"	.530"	.690"	.685"	17/32"	10 Pcs.
12704PK	3/8"-16	.027 - .150"	.530"	.690"	.685"	17/32"	10 Pcs.
12706PK	1/2"-13	.063 - .200"	.685"	1.150"	.865"	11/16"	5 Pcs.

Specialty Nuts

Nutserts Hex Type

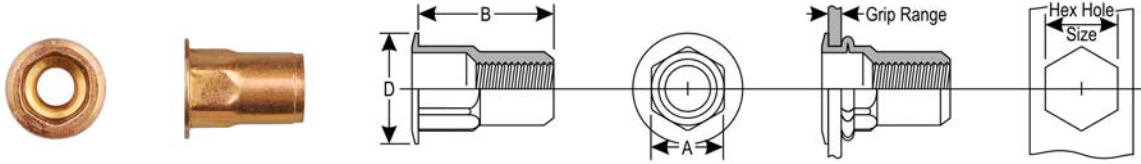

Part #	Thread Size	Grip Range	A	B	D	Drill Size	Qty.
12709PK	6-32	.020 - .080"	.249"	.385"	.375"	1/4"	25 Pcs.
12711PK	8-32	.020 - .080"	.249"	.385"	.375"	1/4"	25 Pcs.
12713PK	10-32	.020 - .130"	.280"	.435"	.390"	9/32"	25 Pcs.
12715PK	1/4"-20	.027 - .165"	.374"	.585"	.510"	3/8"	15 Pcs.
12717PK	5/16"-18	.027 - .150"	.499"	.685"	.655"	1/2"	10 Pcs.
12719PK	3/8"-16	.027 - .150"	.499"	.685"	.655"	1/2"	10 Pcs.
12685PK	4-.70mm	.20 - .30mm	6.35mm	11.05mm	9.53mm	6.35mm	15 Pcs.
10210PK	5-.80mm	.50 - 3.30mm	7.10mm	11.05mm	9.91mm	7.14mm	15 Pcs.
10211PK	6-1.00mm	.70 - 4.20mm	9.50mm	14.86mm	12.96mm	9.53mm	15 Pcs.
12690PK	8-1.25mm	.70 - 3.80mm	12.70mm	17.40mm	16.64mm	12.70mm	15 Pcs.
12692PK	10-1.50mm	.70 - 3.80mm	12.70mm	17.40mm	16.64mm	12.70mm	10 Pcs.

Nuts Acorn With Brass Insert

13242PK 4-.70mm Thread Size
12mm Flange Diameter
10mm Hex Size
Black Nylon Coated
Acorn Nuts With Brass Insert
BMW # 07-13-0-702-715
Honda # 75307-SN7-000

15 Pcs.



Nuts Acorn With Washer

15862PK 5mm Stud Size
10mm Hex Size
18.50mm Flange Diameter
10.50mm Overall Height
Black Nylon Moulding
Flange Nuts
Audi # 171-201-969

25 Pcs.

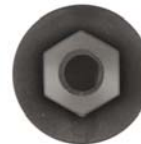

Nuts Jack

1282PK 1/4"-20 Thread Size
1 1/16" Stem Length
1/64 - 3/16" Grip Range
Without Sealer
Steel Jack Nuts

25 Pcs.



9877PK 1/4-20 x 7/8"
3/8" Indented Hex Head
5/8" Outside Diameter Flange Diameter
Black Finish
Truck Mirror Mounting Screws
Use With # 1282
G.M. # 14007510

25 Pcs.













9371PK 1/4"-20 Thread Size
5/8" Stem Length
3/16" - 3/8" Grip Range
Raintite Sealer Type
Steel Jack Nuts
Chrysler # 6031438
G.M. # 367292

25 Pcs.













Specialty Nuts

Nuts Jack

9541PK	1/4-20 x 1" 5/8" Outside Diameter Chrome Finish Outside Mirror Mounting Bolts Use With # 9371 G.M. # 367291, 10001670, 474821	25 Pcs.		
1793PK	6-1.00mm Thread Size Roof Rack Mounting Raintite Sealer Type Steel Jack Nuts G.M. # 14007940	10 Pcs.		
1589PK	6-1.00 x 26.00mm Chrome Finish Outside Mirror Mounting Bolts Use With # 1793 Ford # N801851-S, N800928-S45, N806345-S47, N806345-S433	10 Pcs.		
12649PK	1/4-20 X 7/8" Screw Size Mirror Mounting Phosphate Screw & Zinc Jack Nut Assembly Chrysler # 367292 G.M. # 14007510	15 Pcs.		
9561PK	1/4-20 x 1" Screw Size Mirror Mounting Screw & Jack Nut Assembly G.M. # 367292	10 Pcs.		

Nuts Brass Insert Rubber Well

10035PK	8-32 Screw Size 5/16" Hole Size 7/16" Length .015"-.178" Grip Range Black Rubber With Brass Insert Well Nuts G.M. # 14048060	25 Pcs.		
9891PK	10-32 Screw Size 3/8" Hole Size 33/64" Length .015"-.192" Grip Range Black Rubber With Brass Insert Well Nuts	25 Pcs.		
11284PK	10-32 Screw Size 3/8" Hole Size 5/8" Length .035"-.232" Grip Range Black Rubber With Brass Insert Well Nuts G.M. # 12338025	10 Pcs.		
1095PK	1/4"-20 Screw Size 1/2" Hole Size 19/32" Length .015"-.111" Grip Range Black Rubber With Brass Insert Well Nuts AMC # 4003120 Chrysler # 2094869, 6033705 G.M. # 528846, 342271	25 Pcs.		
11386PK	1/4"-20 Screw Size 1/2" Hole Size 41/64" Length 3/4" Head size Black Rubber With Brass Insert Well Nuts	10 Pcs.		

Specialty Nuts

Nuts Brass Insert Rubber Well

12836PK 5/16"-18 Screw Size
5/8" Hole Size
19/32" Length
27/32" Flange
.015"-.156" Grip Range
Black Rubber With Brass Insert Well Nuts

15 Pcs.



1284PK 6-1.00mm Screw Size
12.70mm Hole Size
14.50mm Length
.015"-.111" Grip Range
Black Rubber With Brass Insert Well Nuts
AMC # 8934201293
G.M. # 15505451

10 Pcs.



11899PK 6-1.00mm Screw Size
12.70mm Hole Size
15mm Length
20mm Flange Diameter
.015"-.094" Grip Range
Roof Rack Mounting
Black Rubber Well Nuts
G.M. # 20130258, 14002811

10 Pcs.



Kits Brass Insert Rubber Well Nut

13363 6-1.00mm Screw Size
1/2" Hole Size
Screw, Washer & Nut
Top Carrier
Black Rubber With Brass Insert
Well Nuts Anchor Kit

10 Sets



Nuts Square Type Cage Standard



Part #	Screw Size	Panel Range	Mounting Hole	Finish	Qty.
11005PK	10-24	.025" - .063"	3/8"	Zinc	50 Pcs.
11006PK	10-24	.064" - .105"	3/8"	Zinc	50 Pcs.
11007PK	10-32	.025" - .063"	3/8"	Zinc	50 Pcs.
11008PK	10-32	.064" - .105"	3/8"	Zinc	50 Pcs.
11009PK	1/4"-20	.025" - .063"	3/8"	Zinc	50 Pcs.
11010PK	1/4"-20	.064" - .105"	3/8"	Zinc	50 Pcs.
11011PK	5/16"-18	.093" - .126"	1/2"	Zinc	50 Pcs.
11012PK	3/8"-16	.093" - .126"	1/2"	Zinc	50 Pcs.

Nuts Square Type Cage Metric



Part #	Screw Size	Panel Range	Mounting Hole	Finish	Qty.
11013PK	5-.80mm	1.626" - 2.667"	3/8"	Zinc	50 Pcs.
11014PK	6-1.00mm	.635" - 1.60"	3/8"	Zinc	50 Pcs.
11015PK	6-1.00mm	1.626" - 2.667"	3/8"	Zinc	50 Pcs.