

# OS HD Series

★ QUALITY SOURCE ★

Production Improvement



# Content

1

Protection against vibration

2

Isolation between battery (cell) blocks

3

BMS mounting

4

Protection on wires

5

Changes on 12V 100Ah cell blocks

6

Cell capacity for HD series battery packs

1

## Protection Against Vibration

- 1.1 Protection on the bottom of cell blocks
- 1.2 Protection on the top of BMS
- 1.3 Protection on the 4 sides of the cell blocks

# 1.1 Protection on the bottom of cell blocks

**Before:** A whole piece of EVA cushion is placed on the bottom of the battery housing.

**After:** EVA cushion is cut into strips, and placed between the screws. The proper thickness and hardness of the EVA cushion is used to ensure the screws of battery cells will not impact against the battery housing during vibration, so protecting the battery cell connections.

**Tips:** Vibration and impact on the screws connecting the cells in long term may cause leakage of the battery cell.

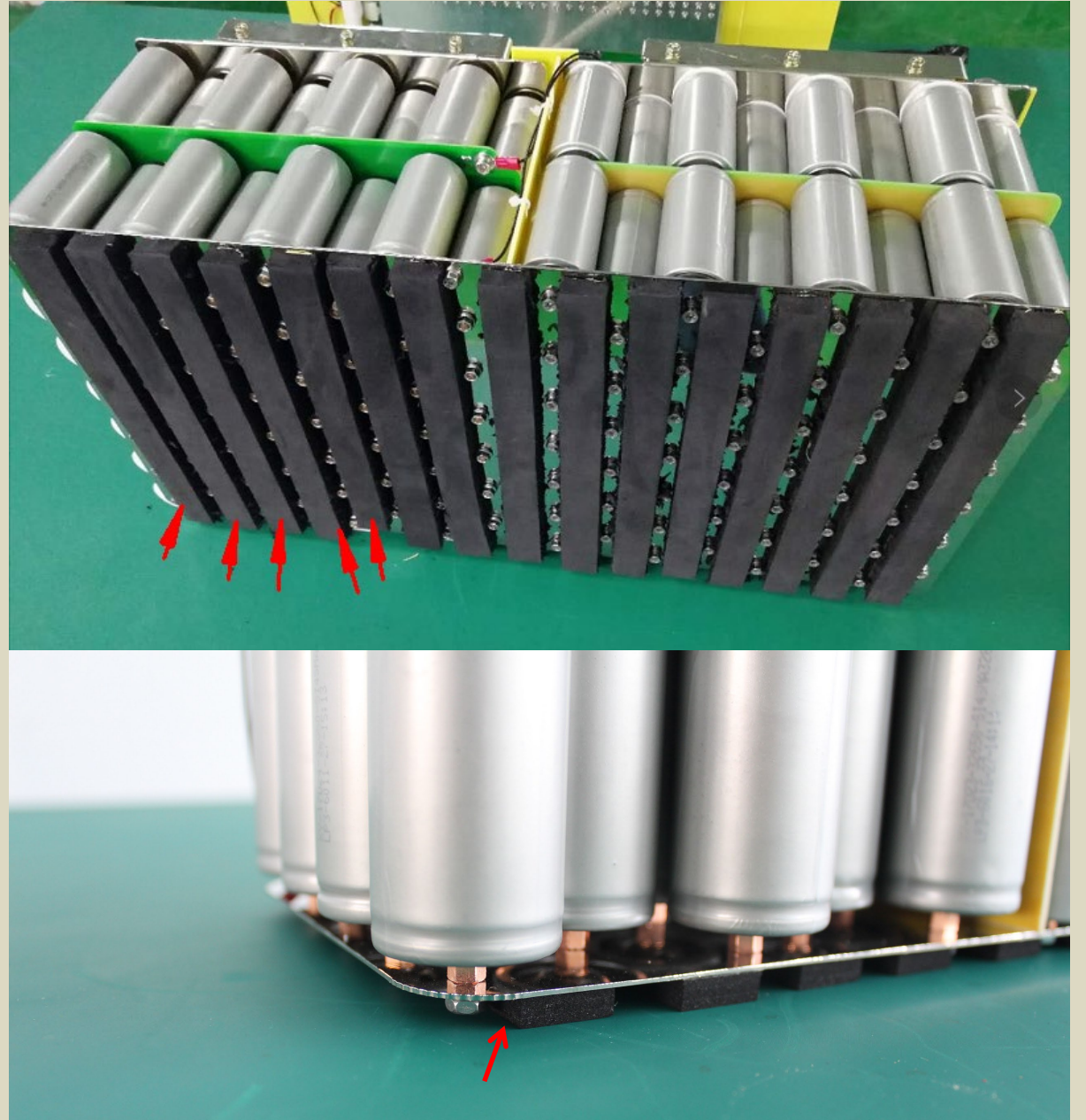

## 1.2 Protection on the top of BMS

**Before:** EVA cushion is used, but without adherence on the protective metal plate of BMS.

**After:** EVA cushion will be adhered to the metal plate with improved fixing.

Reduced risk that the EVA cushion will move and be less effective.

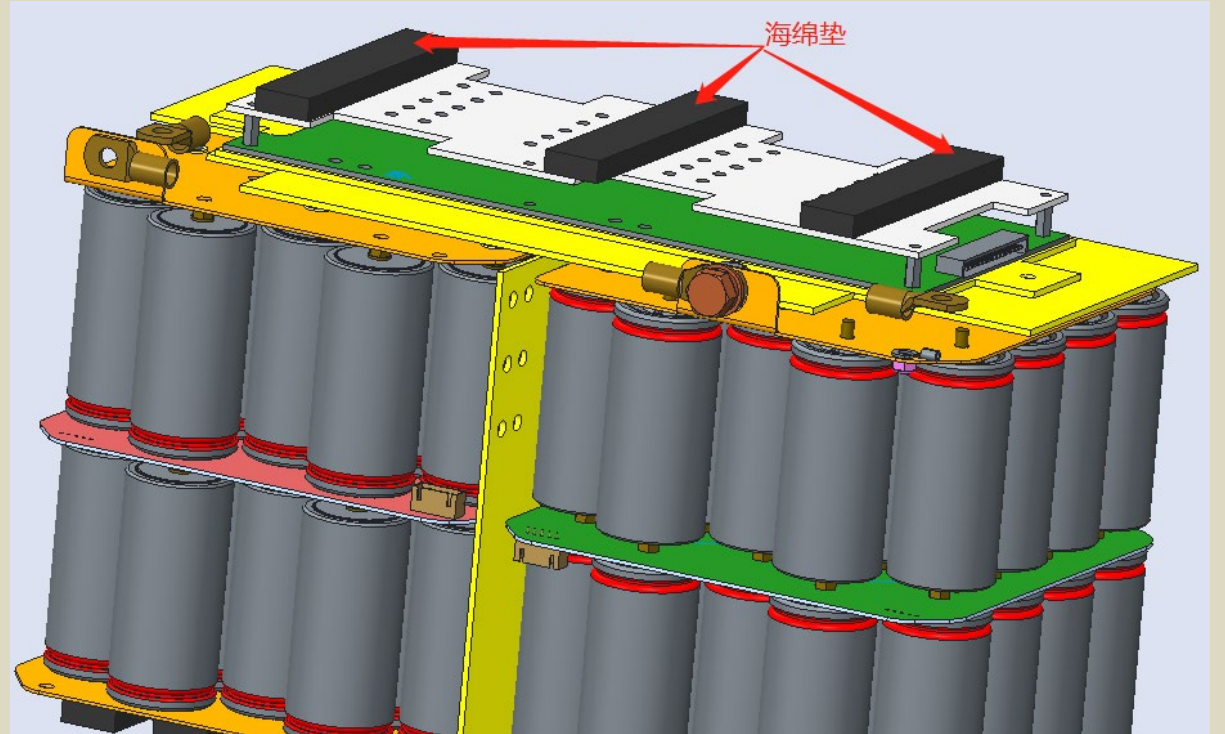

## 1.3 Protection on the 4 sides of the cell blocks

**Before:** EVA cushion is used, but without adherence on the cell blocks or battery housing.

**After:** A larger size EVA cushion will be adhered to the all 4 sides of the battery cell blocks.

This reduces the risk that the EVA cushion will move and be less effective.

**Tips:** EVA cushion on 4 sides of each model HD series battery may be in different thickness, because each model has different tolerance to fit the std battery case size.

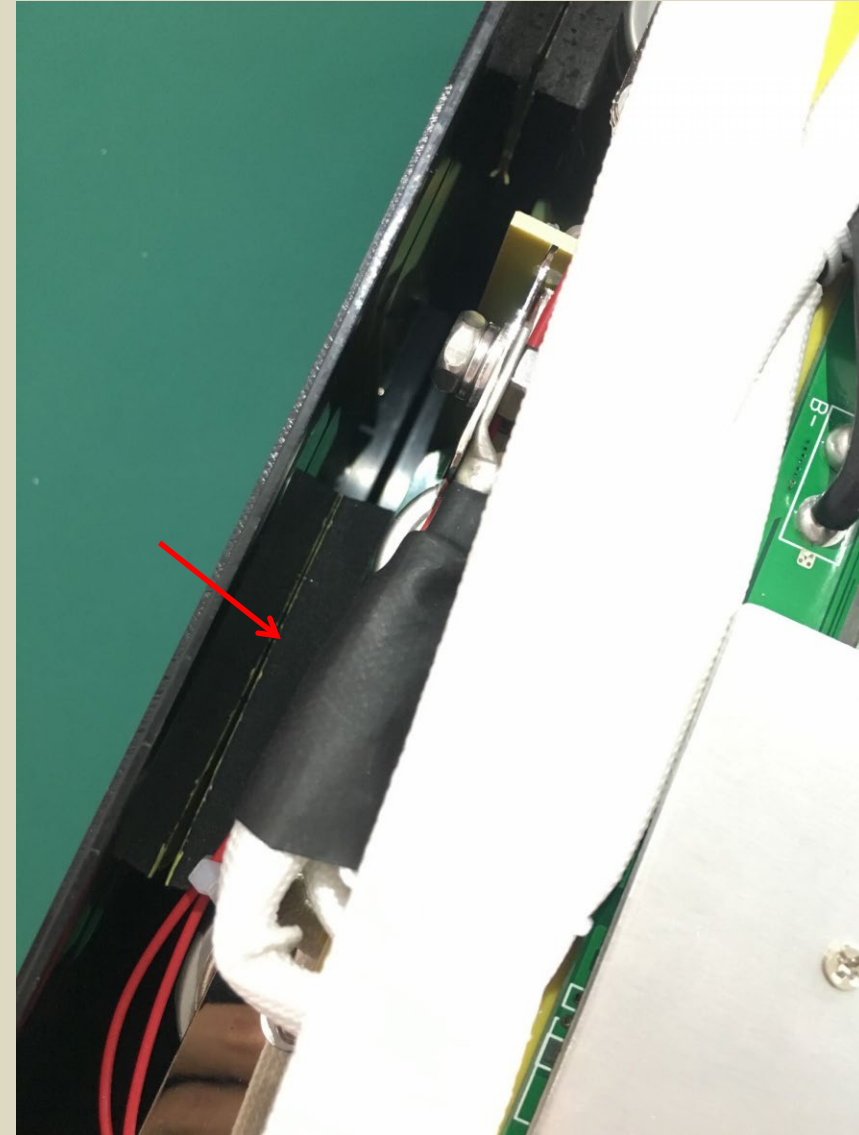

## 2

# Isolation between battery (cell) blocks

2.1 Purpose of isolation

2.2 Isolation on different models

## 2.1 Purpose of isolation

**Before:** Isolate plate between the cell blocks was not adopted on all models of batteries

**After:** All models have isolate plate between the cell blocks. (separate circuit boards)

**Purpose:** Cell blocks are very close to each other, adding additional isolation between each cell block prevents the cell blocks from short circuit in case the outer case of each cell could wear/ Chaffe through over a long period of high vibration and impact.





## 2.2 Isolation on different models



HD12100  
(Epoxy board)



Other Models  
(IBarley Paper)

3

BMS mounting

# BMS mounting

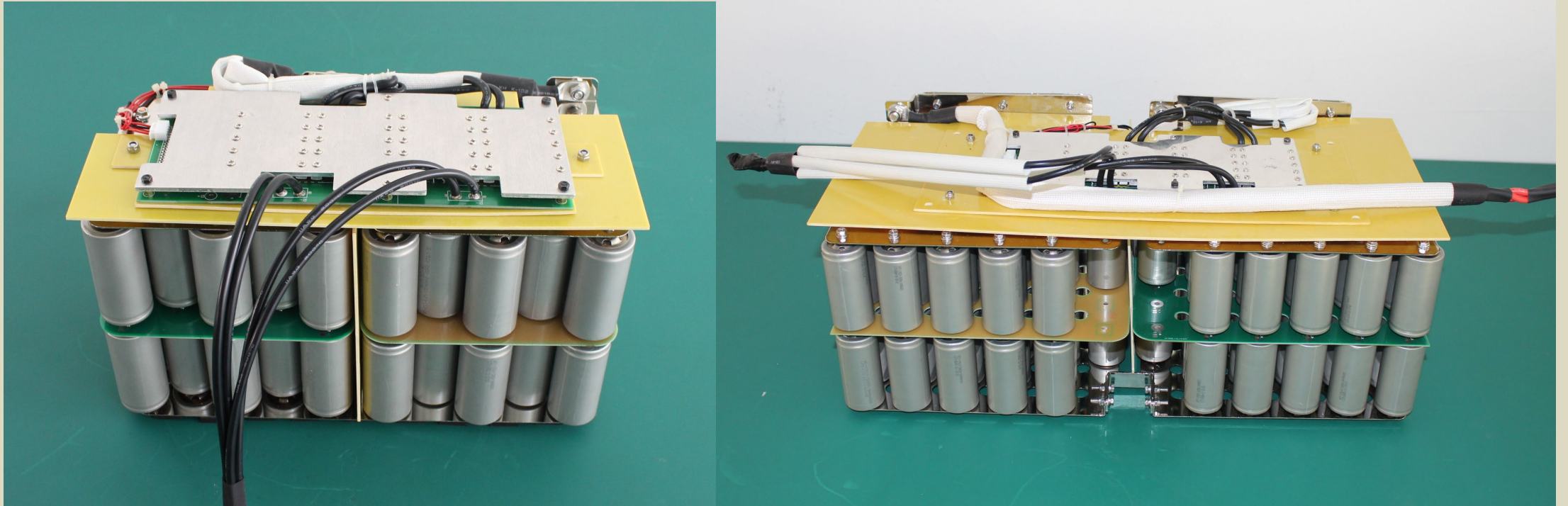

For all models, BMS is mounted on an insulation plate by screw fixing. (QTY of the screws will be different according to different size BMS of each model), stable enough against vibration.

# Mounting of the insulation plate between BMS and cell blocks

1. The insulation plate (epoxy board) is glued to the nickel plated copper plate with EVA cushion.

2. This insulation plate is designed to match size of each battery housing, so that it will not move inside the housing. Reducing loads on the cells through considered design.

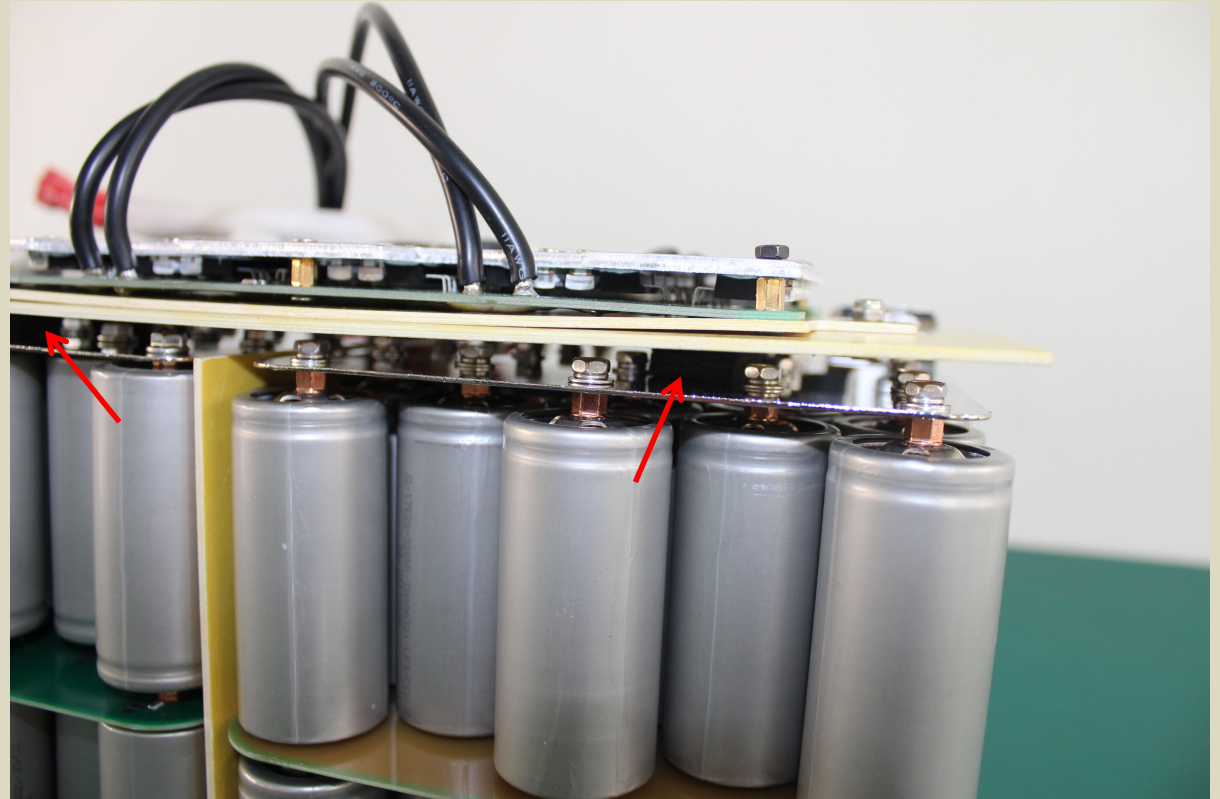

# Mounting of the insulation plate between BMS and cell blocks

3. A smaller size epoxy board is screw fastened on to the bottom insulation plate.

4. The bottom isolation plate is for insulation. This avoids the possible contact of components on BMS from ever being connected to cell blocks that could cause a short-circuit. And, the upper epoxy board is for fixing the BMS, so reducing the strain on electrical connections.

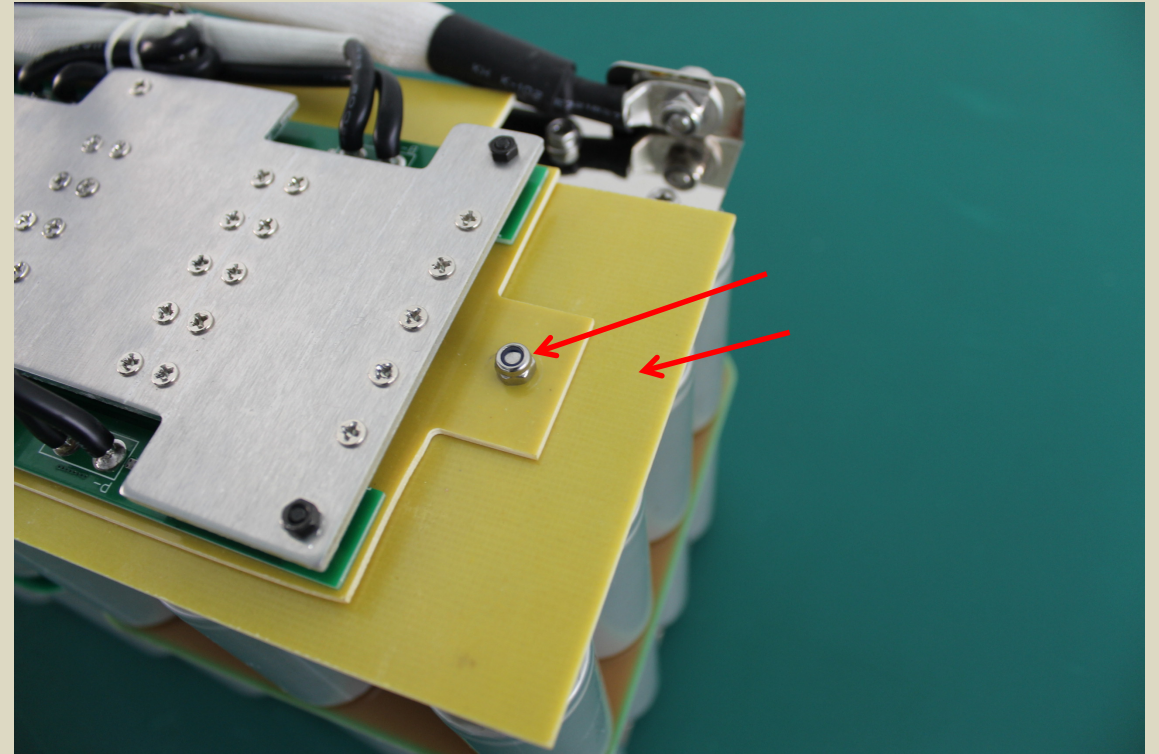

# Mounting of the BMS

5. BMS is screw fastened on the upper epoxy board only.

6. In this way, the screws for mounting the BMS are also isolated from the battery cell blocks, because under the screws, there's the larger size insulation plate.

7. QTY of the screws will be different according to different size BMS of each model.

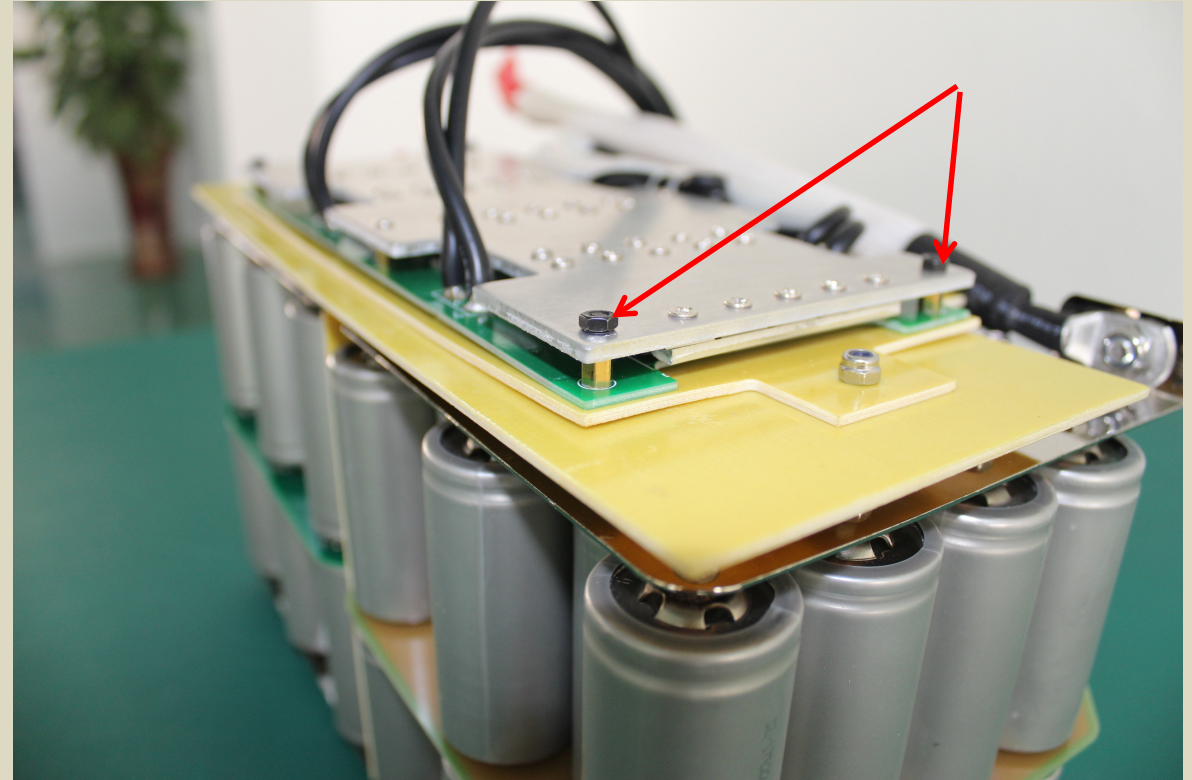

4

## Protection on wires

- 4.1 High quality wires
- 4.2 Protective design

## 4.1 High quality wires

The voltage collection wires are high quality wear-resistant Teflon wires.





## 4.1 Protective design

A small gap on PCB is designed for the wires to go through, so that the wires will not be damaged by mounting and or vibration between cell block parts and housing.

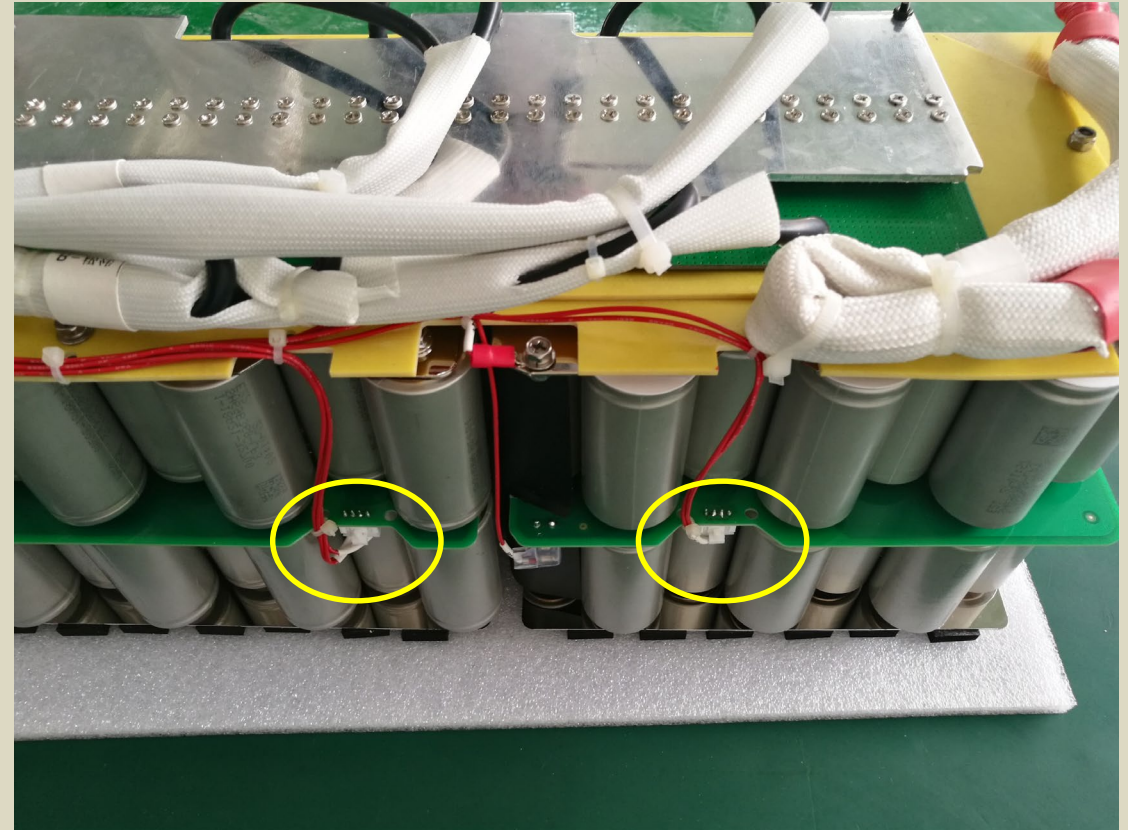

5

Changes on 12V  
100Ah cell blocks

# Changes on 12V 100Ah cell blocks

Old

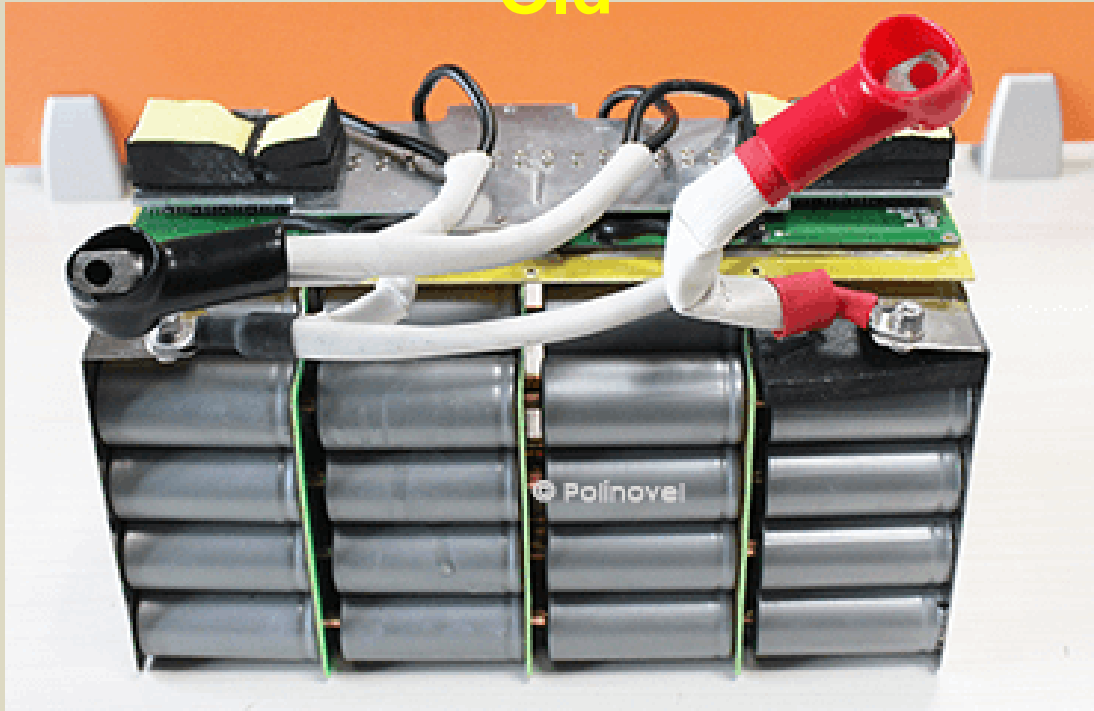

New

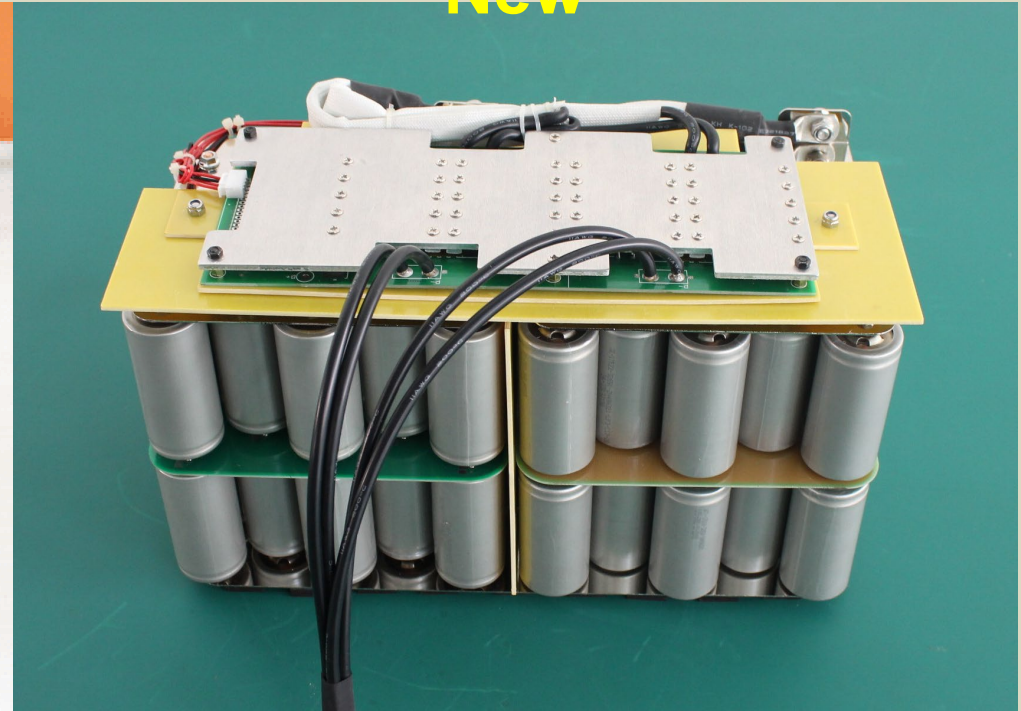

With the new design of cell blocks, we are able to control the quality better than before, meanwhile, increased our production efficiency.