



Intelligent Thread Management

NEW

TMEZ-SC

**Anyone can
be an embroidery
specialist.**

THE WORLD'S FIRST
An innovative embroidery
machine without manual thread
tension adjustment.

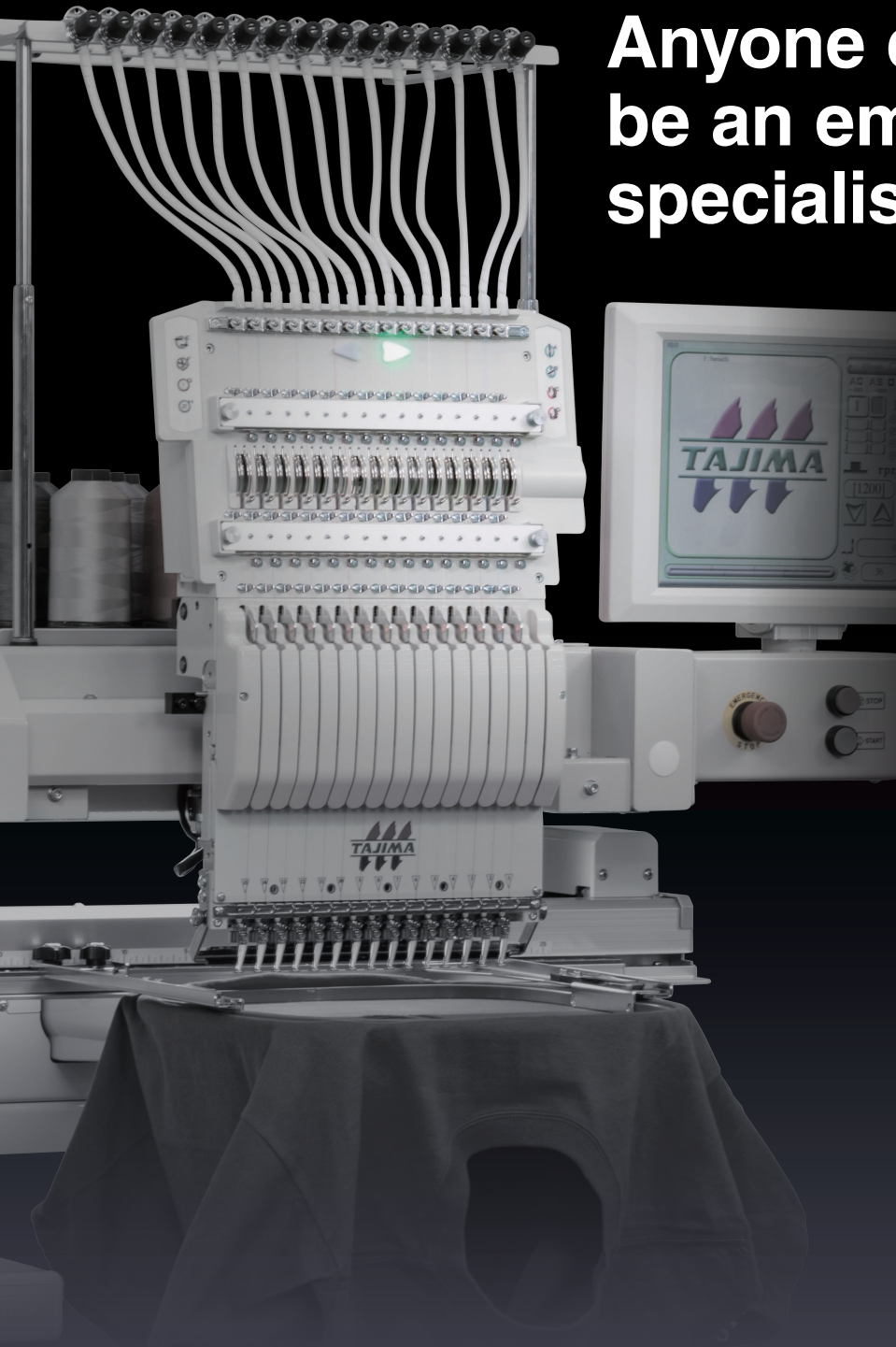

Fashioning your Future Tajima always leads. never follows

What is it about **i-TM** that provides optimal tension adjustment.

Without i-TM

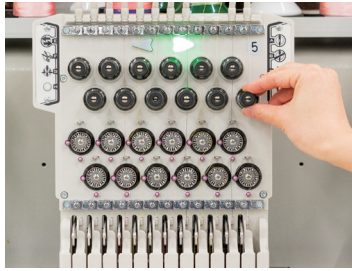

i-TM solves these issues

- ▼ Poor embroidery finish caused by the return twist of the thread.
- ▼ Requires operator skill and experience.
- ▼ The quality of the embroidery finish is inconsistent.
- ▼ The fabric is easily shrunken by embroidery stitch pulling.
- ▼ Requires thread tension adjustment after thread replacement.



i-TM



No need for fine adjustment!

Consistent production!

i-TM is mounted on the tension base in place of the previous tension knobs.

The amount of upper thread supply is automatically calculated according to the stitch type.

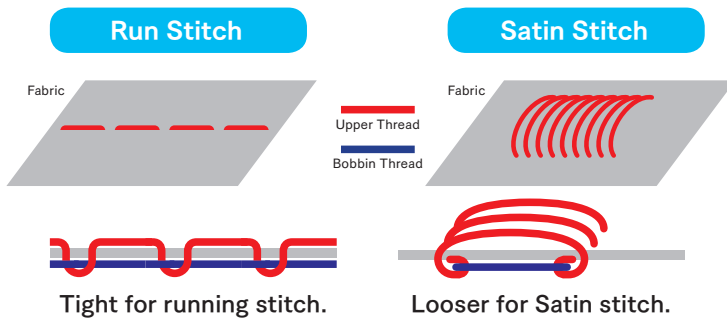

Further adjustment of the tension setting is possible on the operation panel.

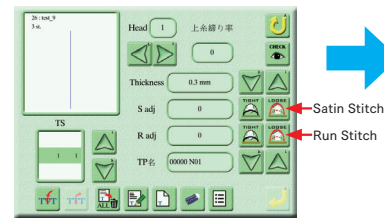

The "Default" setting value is already calculated properly. It is also possible to adjust the thread tension to change the embroidery finish.

Reduces fabric creases

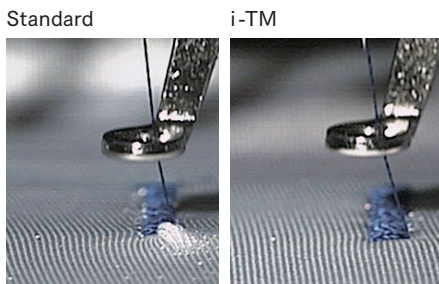

Creases can sometimes occur, depending on the fabric and sewing conditions.

Improved production efficiency

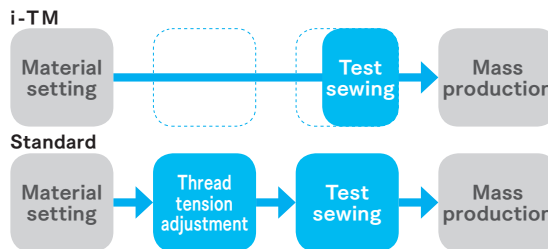

As the appropriate thread tension adjustment is applied regardless of the thread type, mass production can be started quickly.

DCP -Digitally Controlled Presser Foot-



The height of the presser foot can be randomly set according to the material thickness on the operation panel. The fabric does not flutter even when using hard-to-embroider materials like leather, thick fabric, stretchy fabric and quilting.

View by video clip.



Specifications

Needles	15
Factory options	Position Marker, LED Lamp
Dealer options	Stand, Stand Tray, Border Frame, Cap Frame 2
Revolution	Max. 1,200 rpm
Electricity	Single-phase 100-120V, 200-240V, 50Hz/60Hz
Power consumption	160W
Weight	95kg

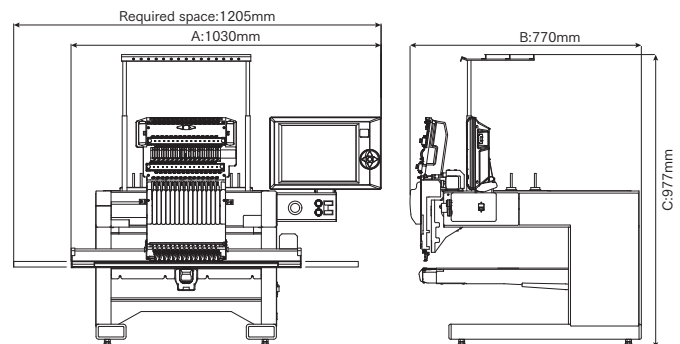

Please contact our distributor listed below.

Seller

Tajima Industries Ltd.

19-22, Shirakabe 3-chome, Higashi-ku Nagoya 461-0011 JAPAN
TEL. +81-52-932-3444, 3445 FAX. +81-52-932-2457, 3449



<http://www.tajima.com>



<https://www.facebook.com/TajimaGroup>

Manufacturer

TISM Co.,Ltd.

* The actual embroidery area and embroidery speed may vary depending on the items being produced, the machine model, and the embroidering conditions.
* Caution: No registered trademark or product design contained in this catalog may be used without prior permission from the manufacturer.
* The specifications and designs of our products are subject to change without notice for performance improvement.