

# TruVue Assembly and Use

---



altwork™

# TruVue - VCS

## Video Conferencing Station



### Packing List

1. Frame with Lights
2. VESA Mount Brackets
3. Slides
4. Camera Mount Assembly
5. Hardware Kit
6. Remote

### WARNING!

- The power cord plug should be firmly inserted in the socket, and the power plug should be pulled out after use to prevent electric shock and fire. The lights can not be controlled fully when the battery power of the remote control is insufficient. Please replace remote battery in time.
- Do not pull out the plug by pulling the power cord. Be sure to hold the plug firmly and pull out of the socket.
- Do not pinch or kink the power cord during adjustment of the lights.
- Do not use when the power cord is damaged, or the plug is worn.
- Don't spray or wash the product with water, and do not place it in a wet and easily splashed place, so as to avoid affecting the electrical insulation performance of the product.

### Product Details:

Lighting solution and webcam mounting system designed to attach to most monitors with an integrated VESA mount including monitors on Altwork Stations Includes:

#### **Mounting frame and hardware:**

- Attaches to monitors with standard 75x75 and 100x100 VESA screw locations
- (4) M4 mounting screws for mounting to your Altwork Station or other VESA mount
- Includes P2 screwdriver for assembly (No other tools required)
- Lighting system with 2 LED panels and manual reset/control switch

#### **Light Panels**

- Source type light: LED
- LED type: "2835"
- LED bulbs: 240 pcs (per panel)
- LED panel size 6-1/4" x 9"
- Dimmable from 0-100%
- Color temperature: 2700K-5700K
- Impute power: AC100-240 VAC 50/60 Hz
- Out power: 42W (per panel)

#### **Lighting remote:**

- Turns lights on/off (Separately or together)
- Adjusts brightness warm to cold (Separately or together)
- Adjusts light intensity (Separately or together)
- (2) AAA batteries (US only)

#### **Webcam Mount:**

- Designed to work for all standard webcams
- Webcam mounts with standard 1/4-20 screw or adhesive tape (included)
- 6" Webcam vertical travel from top of screen
- Retracts out of view above monitor
- Flips down for desk view

# TruVue - vcs

## Attach Brackets to Monitor (With VESA Mount)



1. Use M4 x 14MM screws to attach the bracket to the back of the monitor to the VESA mount threads as shown.



(2) VESA Mount Brackets  
(4) M4 x 14mm flat-head screws

# TruVue - vcs

## Attach to Monitor with VESA Mount (Over Existing Mount)



Remove existing screws from left side of monitor mount.



Use M4 x 20mm flathead screws to mount the bracket to the back of the monitor through the VESA mount as shown.



(2) VESA Mount Brackets  
(4) M4 x 20mm flat-head screws



Remove existing screws from right side of monitor mount.



Attach the right side bracket

# TruVue - vcs

## Attach Slides to VESA Mount Brackets



Use M4 x 12mm pan-head screws to attach Slides to VESA Mount Brackets with screw countersink hole at top facing out and notch facing the monitor as shown. (Start with the slides all the way down on the screws)

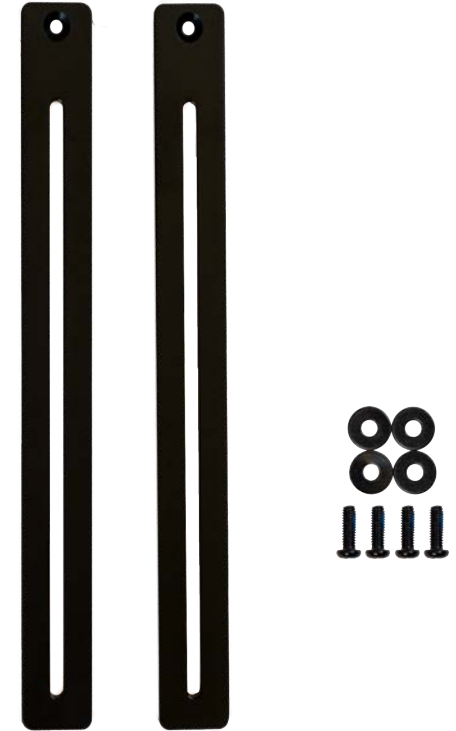

- (2) Slides
- (4) M4 x 12mm pan-head screws
- (4) Large washers

# TruVue - VCS

## Adjust Light Panels for Attachment



Adjust the Light Panels so they are out to the side and folded down as shown, then re-tighten the thumbscrews.

This will make the next step much easier because the frame will now be stable when it is picked up and installed on the Slides.



# TruVue - vcs

## Attach Frame to Slides



Use M4 x 10mm flat-head screws to attach the bar of the Frame to the Slides as shown.



- (1) TruVue Frame
- (2) M4 x 10MM flat-head screws

# TruVue - vcs

## Adjusting the Frame to top of Monitor



Loosen (4) screws to slide the Frame up so that the bar is parallel to and just above the top of the monitor as shown, then re-tighten.



# TruVue - VCS

## Attaching Camera Mount to VCS Frame



Use the M4 x 16mm pan-head screw and small washer to attach the Camera Mount to the Frame.  
Make sure to adjust the location far enough forward to avoid hitting the screen with the Camera Mount when deployed.

- (1) Camera Mount Assembly
- (1) M4 x 16MM pan-head screw
- (1) Small washer

# TruVue - VCS

## Attaching Camera to VCS Mount



1. Remove (3) clamps from Camera Bar
2. Loosen both thumb screws
3. Remove Camera Bar from Slide Block

Note: Thumb nuts and plastic block may need to be removed for larger connectors to be installed through the block.

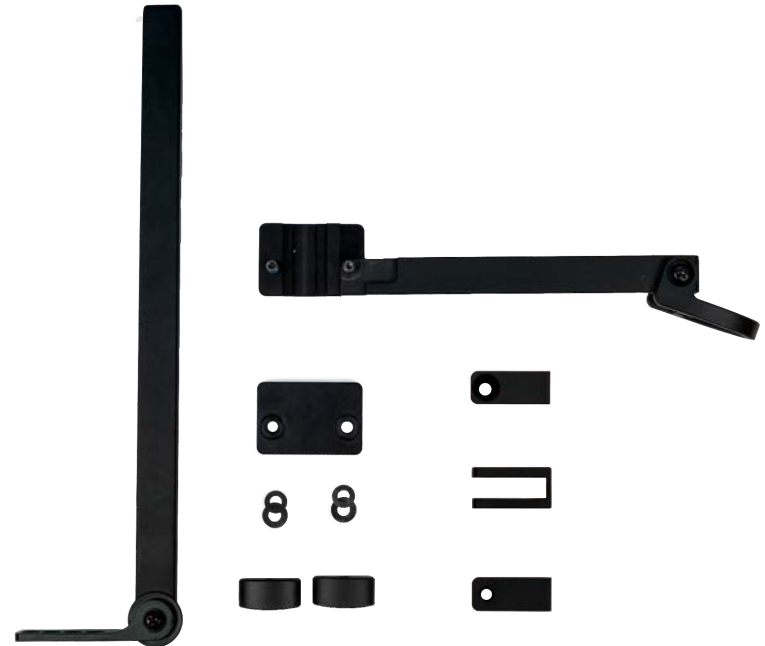

# TruVue - vcs

## Attaching Camera Mount



1. If the camera has a 1/4-20 thread mounting option,
2. select the correct length screw 1/4" or 3/8" from the Hardware Kit.
3. Attach the camera to the Mount through the hole that allows the camera full range of adjustment.



1. If the camera does not have a 1/4-20 thread mounting option, select the Adhesive Tape from the Hardware Kit.
2. Make sure the surface of the Camera and Mount are clean and free of oils then apply Tape to the Camera Mount.
3. Attach the Camera to the Mount onto the tape in a location that allows the camera full range of adjustment.



- (1) 1/4-20 x 1/4"
- (1) Alt 1/4-20 x 3/8"
- (1) Alt Adhesive Tape

# TruVue - vcs

## Camera Wire Management



1. Start with the camera facing down
2. Make sure that the wire is not pulling the back of the camera, press the wire into the groove of the Camera Bar from bottom to top.
3. Attach the Wire Stops at the bottom and top of the Camera Bar as shown
4. Thread cable through the Pivot Guide at the rear of the assembly



Note: Third Wire Stop can be used at an optional point as a preset Stop for the camera position in front of the screen.

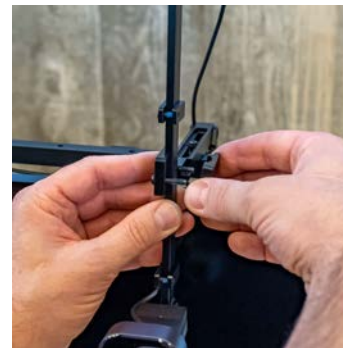

Note: Thumb nuts and plastic block may need to be removed for larger connectors to be installed through the block.

# TruVue - VCS

## Camera Mount Adjustment



Adjust the friction on the Camera Bar slide with the front Thumbscrew



Adjust the friction on the Camera tilt with the screw on the mount



Adjust the friction on the Camera Bar pivot with the screw on the mount



Camera stowed



Camera deployed



Camera desk view



# TruVue - VCS

## Light Panel Adjustment



**NOTE:** To avoid damaging the Light Panels:

- Loosen thumbscrew before adjusting light panels. Retighten after the light is in the desired position.
- Make sure that the power wires do not get kinked or pulled too tight.



# TruVue - vcs

## Light Panel Remote Control



Pointing the remote between the two lights as shown will allow for dual control.



Pointing the remote directly at a single light as shown will allow for independent control.

Note: The IR sensor is in the rear of the Light Panel and may require aiming the remote at the rear of the Light



The Manual Switch can be used to cycle through four different preset lighting conditions by switching off and on repeatedly

Note: Reset and Resync Option:

If the light panels are ever out of sync and it becomes difficult to use the remote to re-sync them, turn of the power switch for at least **(6) seconds** before switching back on. This should bring both lights back on in sync with each other. If more than one TruVue is set up in the same room, the switch can be turned off to prevent overlapping controls when not in use.

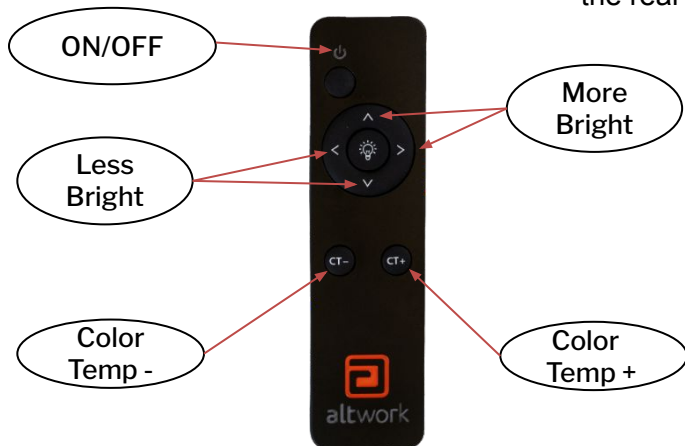

### **WARNING!**

- Use care to install the batteries properly.
- Improperly installed batteries could discharge rapidly and overheat.

# TruVue - vCS

## Light Panel Remote Control



When using the TruVue with an Altwork Station, you may want to add the 1/2" round magnet to the bottom of the remot in order to stick it down to the magnetic desk surface.

# TruVue - Desk Stand

## Desk Stand Assembly



1



2



3



4



5



6

### Packing List:

1. Base Plate
2. Upright (Left)
3. Upright (Right)
4. (6) M4 x 10MM Screws
5. (6) M4 x 6MM Screws
6. (6) Wire Clips

# TruVue - Desk Stand

## Attaching Uprights to Base



If using a Monitor with standard width stand or using the Laptop Tray, use the set of holes that are closer together.



If using a Monitor with wider stand (Like Microsoft Surface) use the set of holes that are farther apart.



Attach the Uprights with grooves facing in and flat sides with screw holes at top facing forward.



Attach Left side Upright to plate with (3) M4 x 10mm screws.



Attach Right side Upright to plate with (3) M4 x 10mm screws.



# TruVue - Desk Stand

## Attaching the VCS Slides to Uprights



Attach VCS Slides to Uprights with M4 x 12MM pan-head screws and large washers. Make sure that the notch at the top of the Slides is facing forward as shown.



- (2) Slides
- (4) M4 x 12MM pan-head screws
- (4) Large washers

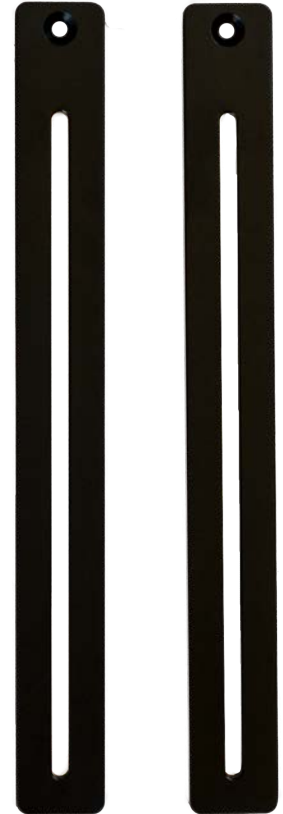

# TruVue - Desk Stand

## Attaching VCS Frame to Slides



Use M4 x 10mm flat-head screws to attach the bar of the Frame to the Slides as shown.

Note that the closer holes are for most monitors and Laptop Tray and the wider holes are for monitors with wider stands such as Microsoft Surface.

- (1) TruVue Frame
- (2) M4 x 10MM flat-head screws



# TruVue - Desk Stand

## Adjusting VCS Frame to Top of Monitor



1. Start by setting your monitor behind the Desk Stand in order to see both the height you want and access the screws at the same time.
2. Loosen (4) screws to slide the Frame up so that the bar is parallel to and just above the top of the monitor as shown, then re-tighten.
3. Once the Frame is at the correct height, move the monitor to the front of the posts and position it so it is centered and as close to the posts as possible while still being able to tilt as needed.



# TruVue - Desk Stand

## Installing cable management



Use Wire Clips to to capture the camera power or other wires.

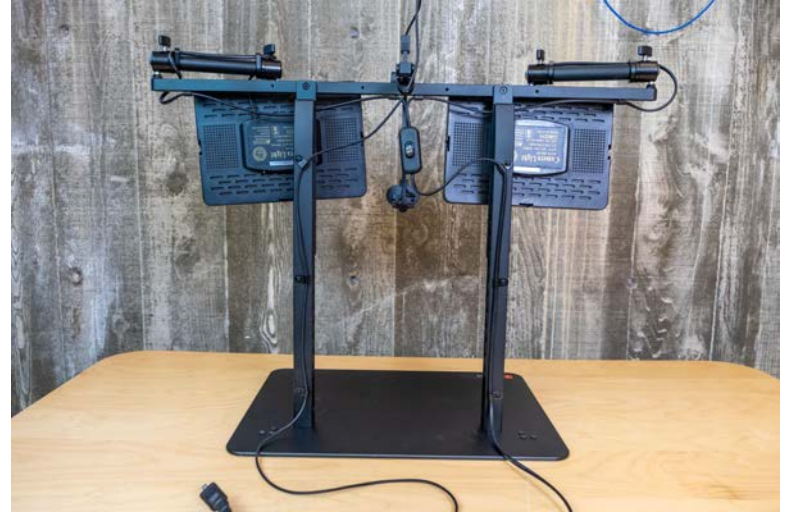
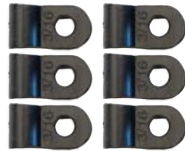

Use M4 x 6MM Screws to attach Wire Clips to the back of the Uprights



# TruVue - Laptop Tray

## Laptop Tray Assembly



### Packing List:

1. Laptop Plate
2. Bracket (Left)
3. Bracket (Right)
4. (4) M4 x 8MM flat-head screws

# TruVue - Laptop Tray

## Laptop Tray Assembly



1. Attach the left and right brackets with plastic slides facing out as shown  
**(Chose the set of holes that best fits the laptop to be used)**
2. Leave one rear screw out on one of the brackets
3. Guide the Laptop Plate bracket posts into the groove then install the final screw

- (1) Laptop Plate
- (1) Bracket (Left)
- (1) Bracket (Right)
- (4) M4 x 8MM flat-head screws



# TruVue - Laptop Tray

## Laptop Tray Assembly

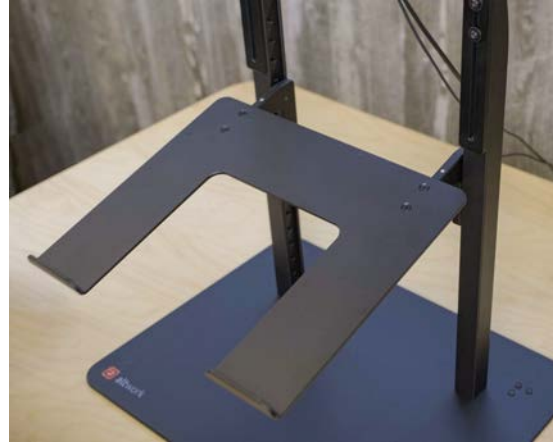

Tilt the Laptop Tray up in order to adjust to the desired height.

Set Laptop on Tray and adjust camera as needed

# TruVue - Laptop Tray

## Laptop Tray Assembly



Laptop at lowest position



Laptop at mid position



Laptop at higher position