

ELMO

VISUAL PRESENTER

MX-P3

INSTRUCTION MANUAL



HDMI™
HIGH-DEFINITION MULTIMEDIA INTERFACE

■ IMPORTANT SAFEGUARDS

Make sure to read the “IMPORTANT SAFEGUARDS” in this guide before using this product.

For details about specifications and instruction manual of the product, refer to the following official website.

<https://www.elmoussa.com>

<https://www.elmoeurope.com>

■ Read Instructions

All the safety and operating instructions should be read before the appliance is operated.

■ Retain Instructions

The safety and operating instructions should be retained for future reference.

■ Heed Warnings

All warnings on the product and in the operating instructions should be adhered to.

■ Follow Instructions

All operating and use instructions should be followed.

■ Cleaning

Unplug this product from the wall outlet before cleaning. Do not use liquid cleaners or aerosol cleaners. Use a damp cloth for cleaning.

■ Attachments

Do not use attachments not recommended by the product manufacturer as they may cause hazards.

■ Water and Moisture

Do not use this product near water - for example, near a bath tub, wash bowl, kitchen sink, or laundry tub, in a wet basement, or near a swimming pool, and the like.

■ Placement

Do not place this product on an unstable cart, stand, tripod, bracket, or table. The product may fall, causing serious injury to a child or adult, and serious damage to the product.

Use only with a cart, stand, tripod, bracket, or table recommended by the manufacturer, or sold with the product. Any mounting of the product should follow the manufacturer's instructions, and should use a mounting accessory recommended by the manufacturer.

■ Ventilation

Slots and openings in the cabinet are provided for ventilation and to ensure reliable operation of the product and to protect it from overheating, and these openings must not be blocked or covered. The openings should never be blocked by placing the product on a bed, sofa, rug, or other similar surface. This product should not be placed in a built-in installation such as a bookcase or rack unless proper ventilation is provided or the manufacturer's instructions have been adhered to.

■ Power Sources

This product should be operated only from the type of power source indicated on the marking label. If you are not sure of the type of power supply to your home consult your appliance dealer or local power company. For products intended to operate from battery power, or other sources, refer to the operating instructions.

■ Grounding or Polarization

This product may be equipped with either a polarized 2-wire AC line plug (a plug having one blade wider than the other) or a 3-wire grounding type plug, a plug having a third

(grounding) pin. If the 2-Wire polarized plug will not fit in the outlet, try reversing the plug. If the plug still fails to fit, contact your electrician to replace your obsolete outlet. Do not defeat the safety purpose of the polarized plug. The 3-wire grounding type plug will fit into a grounding type power outlet.

This is a safety feature. If you are unable to insert the plug into the outlet, contact your electrician to replace your obsolete outlet. Do not defeat the safety purpose of the grounding type plug.

■Power-Cord Protection

Power-supply cords should be routed so that they are not likely to be walked on or pinched by items placed upon or against them, paying particular attention to cords at plugs, convenience receptacles, and the point where they exit from the product.

■Lightning

For added protection for this product during a lightning storm, or when it is left unattended and unused for long periods of time, unplug it from the wall outlet and disconnect the antenna or cable system. This will prevent damage to the product due to lightning and power-line surges.

■Overloading

Do not overload wall outlets, extension cords, or integral convenience receptacles as this can result in a risk of fire or electric shock.

■A product and cart combination should be moved with care. Quick stops, excessive force, and uneven surfaces may cause the product and cart combination to overturn.



■Object and Liquid Entry

Never push objects of any kind into this product through openings as they may touch dangerous voltage points or short-out parts that could result in a fire or electric shock. Never spill liquid of any kind on the product.

■Servicing

Do not attempt to service this product yourself as opening or removing covers may expose you to dangerous voltage or other hazards. Refer all servicing to qualified service personnel.

■Damage Requiring Service

Unplug this product from the wall outlet and refer servicing to qualified service personnel under the following conditions:

- When the power-supply cord or plug is damaged.
- If liquid has been spilled, or objects have fallen into the product.
- If the product has been exposed to rain or water.
- If the product does not operate normally by following the operating instructions. Adjust only those controls that are covered by the operating instructions as an improper adjustment of other controls may result in damage and will often require extensive work by a qualified technician to restore the product to its normal operation.
- If the product has been dropped or damaged in any way.
- When the product exhibits a distinct change in performance - this indicates a need for service.

■Replacement Parts

When replacement parts are required, be sure the service technician has used replacement parts specified by the manufacturer or have the same characteristics as the original part. Unauthorized substitutions may result in fire, electric shock or other



hazards.

■ Safety Check

Upon completion of any service or repairs to this product, ask the service technician to perform safety checks to determine that the product is in proper operating condition.

■ Heat

The product should be situated away from heat sources such as radiators, heat registers, stoves, or other products (including amplifiers) that produce heat.

	CAUTION RISK OF ELECTRIC SHOCK DO NOT OPEN	
<p>CAUTION: TO REDUCE THE RISK OF ELECTRIC SHOCK, DO NOT REMOVE COVER (OR BACK). NO USER-SERVICING TO QUALIFIED SERVICE PERSONNEL.</p>		



SA 1965

The lightning flash with arrowhead symbol, within an equilateral triangle, is intended to alert the user to the presence of uninsulated “dangerous voltage” within the product’s enclosure that may be of sufficient magnitude to constitute a risk of electric shock to persons.



SA 1966

The exclamation point within an equilateral triangle is intended to alert the user to the presence of important operating and maintenance (servicing) instructions in the literature accompanying the product.

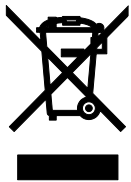

This symbol [crossed-out wheeled bin WEEE Annex IV] indicates separate collection of waste electrical and electronic equipment in the EU countries. Please do not throw the equipment into the domestic refuse. Please use the return and collection systems available in your country for the disposal of this product.

WARNING

TO REDUCE THE RISK OF FIRE OR ELECTRIC SHOCK, DO NOT EXPOSE THIS PRODUCT TO RAIN OR MOISTURE.

The connection of a non-shielded equipment interface cable to this equipment will invalidate the FCC Certification or Declaration of this device and may cause interference levels which exceed the limits established by the FCC for this equipment. It is the responsibility of the user to obtain and use a shielded equipment interface cable with this device. If this equipment has more than one interface connector, do not leave cables connected to unused interfaces. Changes or modifications not expressly approved by the manufacturer could void the user’s authority to operate the equipment.

**FOR UNITED STATES USERS:
INFORMATION**

This equipment has been tested and found to comply with the limits for a Class A digital device, pursuant to Part 15 of the FCC Rules. These limits are designed to provide reasonable protection against harmful interference when the equipment is operated in a commercial environment. This equipment generates, uses, and can radiate radio frequency energy and, if not installed and used in accordance with the instruction manual, may cause harmful interference to radio communications. Operation of this equipment in a residential area is likely to cause harmful interference in which case the user will be required to correct the interference at his own expense.

USER-INSTALLER

CAUTION:

Your authority to operate this FCC verified equipment could be voided if you make changes or modifications not expressly approved by the party responsible for compliance to Part 15 of the FCC rules.

BEFORE USE

- Be sure to use the supplied power cord and the AC adapter.
- The power cord and AC adapter that come with this product are for this product only. Do not use them with another product.
- Be sure to use the power cord applicable to your local power specifications. If the product was sold in Japan, use the AC adapter sold with the product with 100 VAC and 50 or 60 Hz.
- When storing the product, do not leave it under direct sunlight or by heaters. It may be discolored, deformed, or damaged.
- Do not place this product in any humid, dusty, salt bearing wind, or vibrating locations. Use it under the following environmental conditions:
 - Temperature : 0°C ~ 40°C
 - Humidity : 30% ~ 85% (No condensation)
- Use a soft, dry cloth for cleaning. Do not use any volatile solvent such as thinner or benzene.
- Luminescent and Black Spots
There may be some pixels that do not properly operate due to the use of CMOS Area Image Sensors made-up of many pixels.
Though luminescent or black spots may be found on the screen, it is a phenomenon peculiar to the CMOS Area Image Sensors and is not a malfunction.
- Follow the guidelines below to prevent the unit from dropping or overturning.
 - Use the product on a stable base, desk, or table. Do not place the product on an unstable base or slanted location.
 - Place or wire the product so as to prevent the cables from being pulled or drawn.
- Do not point the lens directly to the sun. It could degrade the imaging capability.
- Do not look directly into the LED light. If you look directly into it at pointblank range, your eyes may be injured.
- If this product is used for longer than the warranty period, its performance and quality may deteriorate due to the lifetime of its parts. For parts replacement (on chargeable basis), consult the dealer from whom you purchased this product or our branch/office near your location.
- Microphone
Connecting a microphone other than an electret condenser microphone (a microphone for a computer) may cause malfunction.
- A magnet is in the bottom of the product. Keep the bottom of the product away from devices and objects that could be damaged by strong magnetic fields (such as a computer, monitor, and magnetic card).
If the product is installed to the wall or place which is not level with the magnet, it may fall. Be sure to confirm that the product is installed securely before use.

CAUTION * * * * * For Europe only * * * * *

The maximum recording time is 29minutes 50seconds.

The video recording will stop automatically when the recording time exceeds this limit.

HANDLING PRECAUTIONS

The followings are special precautions against mishandling of the product. Pay close attention to them.

① Installation

Do not place the product on an unstable place.

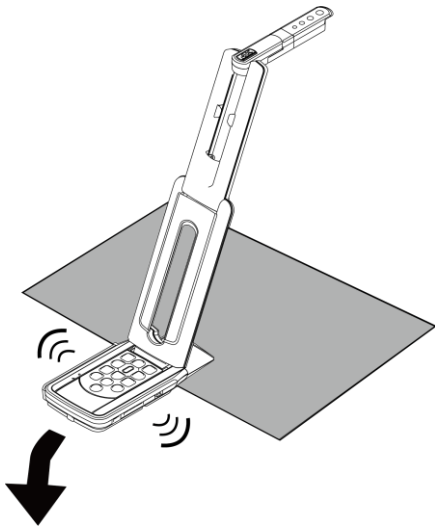

② Setting up

When setting up the product, hold the body around the operating panel.
Be careful not to pinch your fingers.

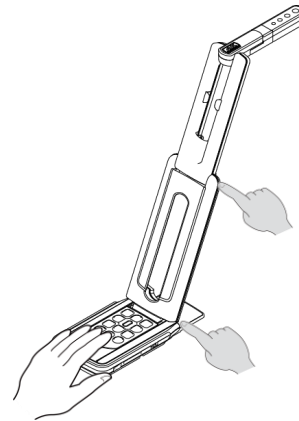

③ Carrying the product

Carry the product by folding the arm so as not to damage the camera.
Do not carry by holding the arm or camera head.

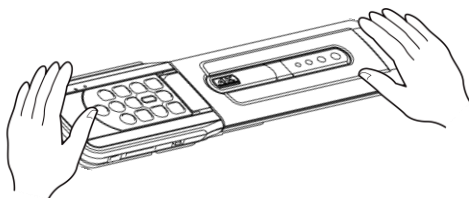

④ Stage

There is a magnet in the bottom of the product. Do not let the product go near objects that can be affected by magnetic fields, such as computers, monitors and magnetic cards.

If the product is installed to the wall or place which is not level with the magnet, it may fall. Be sure to confirm that the product is installed securely before use.

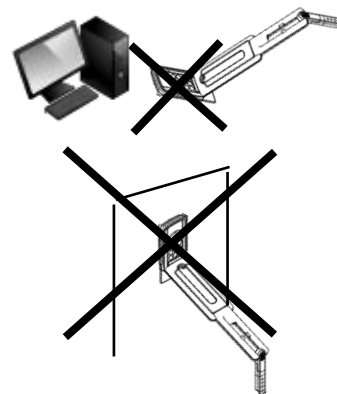

■ TABLE OF CONTENTS

■ IMPORTANT SAFEGUARDS	2
BEFORE USE	5
HANDLING PRECAUTIONS	6
■ TABLE OF CONTENTS	7
① PREPARATION	9
◆ PACKAGE CONTENTS	9
② BASIC OPERATIONS	10
◆ THE NAME OF EACH PART	10
◆ CAMERA OPERATIONS	11
◆ MENU OPERATIONS	12
◆ STATUS LED	13
◆ AUDIO STATUS LED	13
◆ CABLE CONNECTION	14
◆ SETTING SWITCH	14
◆ RESOLUTION / FRAME RATE (WHEN DISPLAYING ON A COMPUTER VIA USB)	15
◆ SIZE OF IMAGES BEING OUTPUT	16
◆ Anti theft lock hole	17
③ PREPARATION AND CONNECTION	18
◆ SETTING UP	18
◆ MOVING PARTS OF THE PRODUCT	19
◆ CONNECTING TO A PROJECTOR OR MONITOR	20
◆ CONNECTING TO A COMPUTER	20
◆ CONNECTING TO A PROJECTOR (OR MONITOR) AND COMPUTER SIMULTANEOUSLY	21
④ USING THE PRODUCT	22
◆ ADJUSTING THE SIZE	22
◆ ADJUSTING THE BRIGHTNESS	22
◆ ADJUSTING THE FOCUS	22
◆ PAUSING THE IMAGE	23
◆ ROTATING THE IMAGE	23
◆ MIRROR INVERT THE IMAGE	23
◆ TURNING ON/OFF THE LED LIGHTING	23
◆ TURNING ON/OFF THE AUDIO OUTPUT	23
◆ SETTING THE CAMERA TO STANDBY STATUS (ONLY AVAILABLE WHEN USING DC POWER CORD)	23
⑤ RECORDING CAMERA IMAGES	24
◆ VIDEO RECORDING	24
◆ STILL IMAGE RECORDING	24

⑥ CONFIGURING THE SETTINGS	25
◆HOW TO CONFIGURE THE SETTINGS	25
◆SETTINGS MENU	25
⑦ FW UPDATE PROCEDURE	28
⑧ ABOUT VIEWER SOFTWARE.....	29
◆INSTALLING THE SOFTWARE	30
⑨ TROUBLE SHOOTING.....	31
◆SYMPTOMS AND POSSIBLE CAUSES/REMEDIES.....	31
⑩ SPECIFICATION	33
◆MAIN CAMERA	33
◆FUNCTIONAL SPECIFICATION	33
◆ILLUMINATION DEVICE	34
◆OTHER SPECIFICATIONS.....	34
■ TRADEMARKS AND LICENSES.....	35

1 PREPARATION

◆ PACKAGE CONTENTS

The items below are included with this product. If any item is missing, contact the dealer from whom you purchased this product.

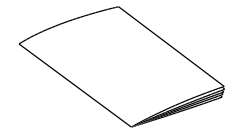
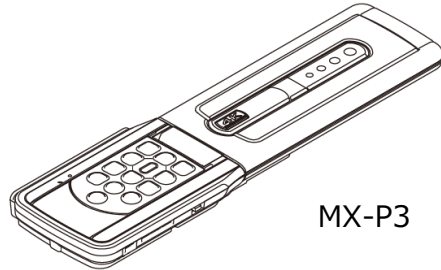

Quick Start Guide

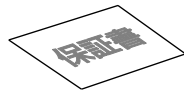

Warranty Card
(For Japan/ North America only)

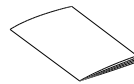

IMPORTANT SAFEGUARDS

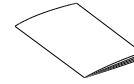

3S service registration sheet (For Japan only)

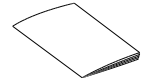

3S Service registration manual (For Japan only)

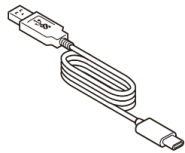

TypeC-A cable

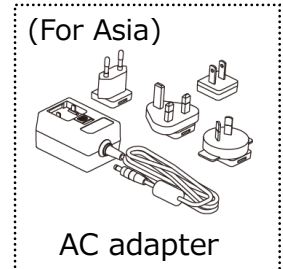
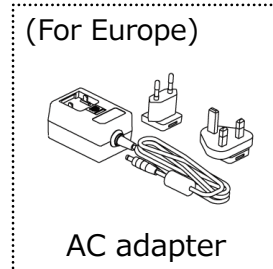
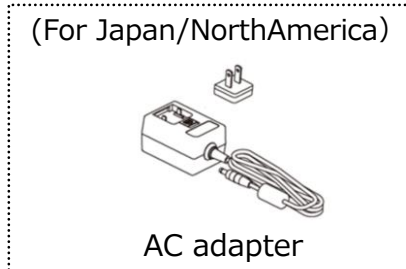

●About AC adapter

Fit the convex part of the plug in the groove of the AC adapter and push it downward.

※Push it until you hear “click”.

※Choose the correct plug according to the outlet.

When removing the plug from the AC adapter, slide the lock button to the direction of ▼ and pull the plug upward.

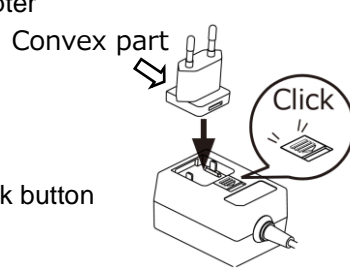

CAUTION

Do not wrap the power cable tightly around the AC adapter. The cable could be damaged (disconnected) or the inside of the cable could be exposed and result in an accident.

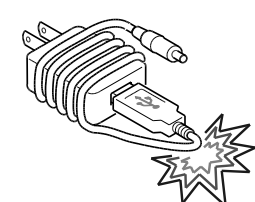

② BASIC OPERATIONS

◆ THE NAME OF EACH PART

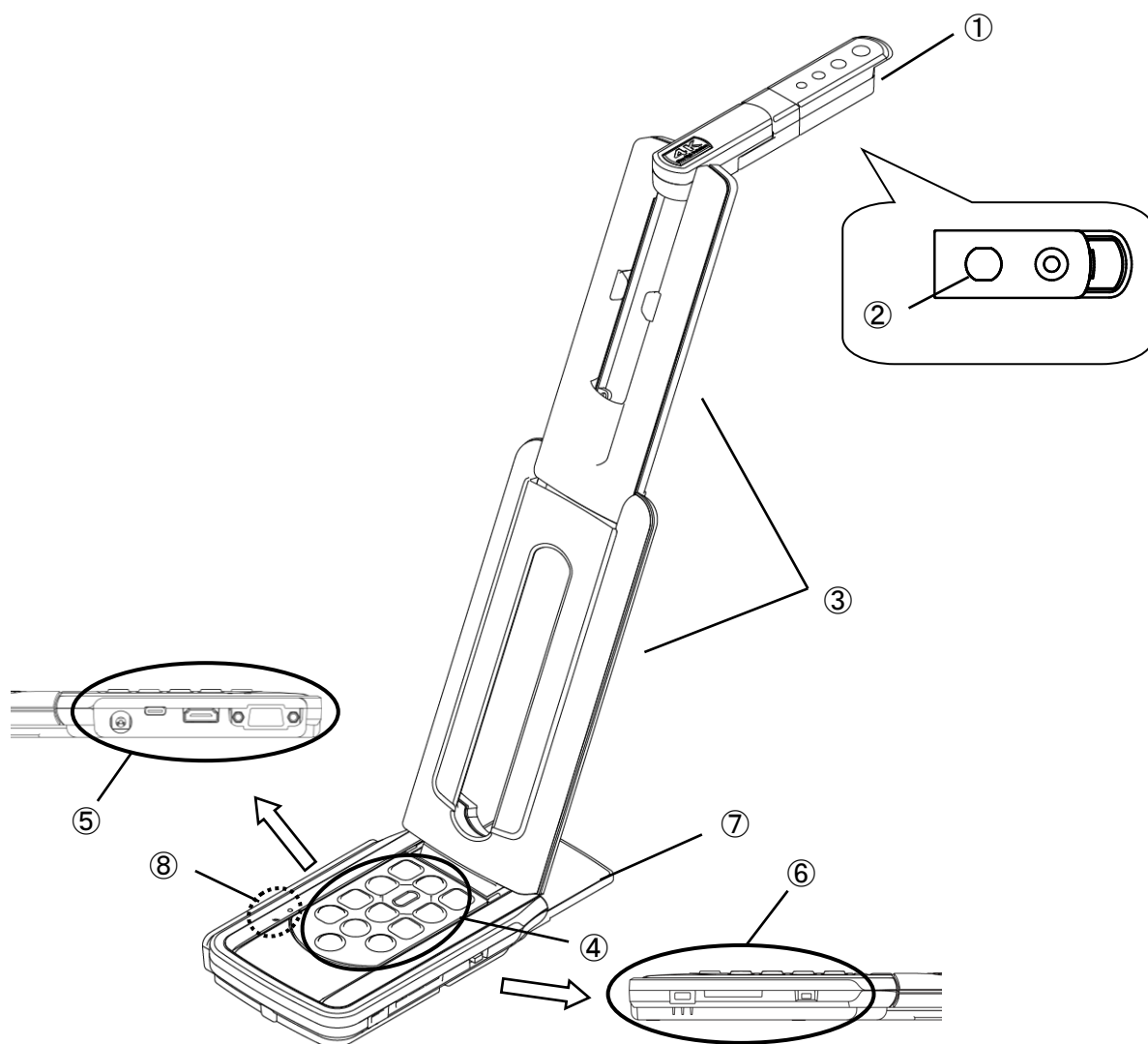

	Name
①	Camera head
②	LED lighting
③	Arm
④	Operating panel
⑤	Connection ports
⑥	Anti theft lock hole/ SD card slot/ Setting switches
⑦	Stage
⑧	Microphone/ Microphone status LED

◆CAMERA OPERATIONS

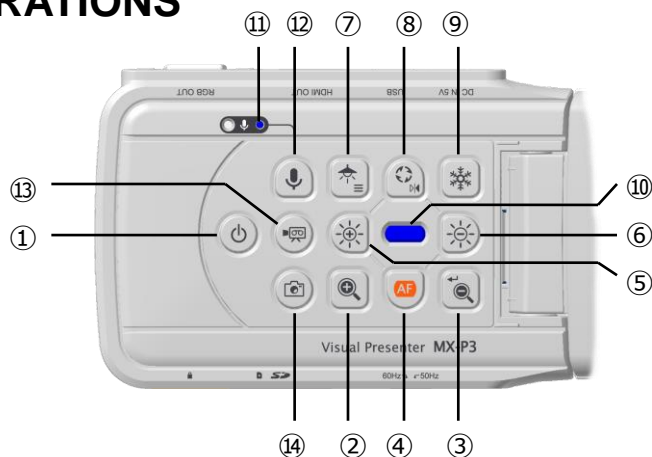

	Function	Description
①	Power	<p><u>Power ON</u></p> <p>The product enters the standby status in 5 – 10 seconds after the DC power cord is connected to the product. (Status LED : Red)</p> <p>To turn on the product, press the Power button. The Status LED turns blue or green and the product starts to output images from HDMI Out port or RGB Out port.</p> <p><u>Power OFF</u></p> <p>To turn off the product, press the Power button again. The Status LED turns red and the product returns to the standby status.</p> <p>※The Power button is disabled when the power is supplied through the TypeC-A cable only.</p>
②	ZOOM-IN	To enlarge the image.
③	ZOOM-OUT	To shrink the image.
④	One-push AF	To focus automatically.
⑤	Brightness+	To brighten the image.
⑥	Brightness-	To darken the image.
⑤+⑥	Initialization of the brightness	To initialize the brightness level by pressing ⑤ and ⑥ together.
⑦	Lighting/MENU	<p>To turn on or off the LED lighting.</p> <p>Long-press this button to display the OSD menu.</p>
⑧	Image rotation/ Mirror inversion	To rotate the image. (0°/180°) ※The image will be flipped horizontally when this button is long pressed (about 3 seconds).
⑨	Freeze	To pause or restart the image.
⑩	Status LED	<p>To indicate the status of the product.</p> <p>For details, refer to “◆Status LED”(⇒P.13).</p>

⑪	Audio status LED	To indicate the status of the audio output. This LED turns blue when the audio output is on.
⑫	Audio ON/OFF	To turn on or off the audio. ※ This function is available only when outputting images to a computer via the TypeC-A cable or recording images to an SD card. (Default setting: OFF)
⑬	Record	To record videos to an SD card.
⑭	Capture	To save still images to an SD card.
③+⑥	HDMI resolution switching	To switch the resolution of the HDMI output. (Auto/4K/2K)
④+⑧	Interactive Whiteboard R1 mode	If you press and hold ④ and ⑧ at the same time, it will be the best mode for displaying on our Interactive Whiteboard (model number EL55R1, EL65R1, EL75R1, EL86R1) via TypeC-A cable.
⑦+⑨	Initialization	The Status LED flashes blue when the power is supplied to the product with the TypeC-A cable or DC power cord while pressing ⑦ and ⑨ at the same time. The product will be reset to factory default settings after the TypeC-A cable or DC power cord is disconnected.

◆ MENU OPERATIONS

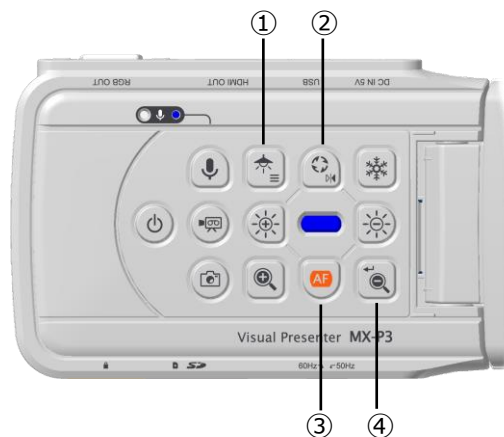

	Function	Description
①	MENU	To display or hide the OSD menu on the image (HDMI/RGB/USB) by long-pressing this button.
②	Move upward	To move the cursor upward.
③	Move downward	To move the cursor downward.
④	Enter	To confirm the menu item.

◆ STATUS LED

The connection status of the AC adapter and TypeC-A cable, power supply status, or image output status can be checked with the Status LED.

Status LED		Power supply			Interactive Whiteboard R1 mode	Power Button	Image output		
Freeze OFF	Freeze ON	AC adapter	USB	Power supply			USB	HDMI	RGB
Off	Off	Off	Off	Off	-----	Disabled	×	×	×
Blue	Flash Yellow	Off	On	USB	×	Disabled	○	×	×
Green	Flash Yellow	Off	On	USB	○	Disabled	○	×	×
Red	-----	On	Off	AC adapter	-----	OFF	×	×	×
Blue	Flash Yellow	On	Off	AC adapter	×	ON	×	○	○
Green	Flash Yellow	On	Off	AC adapter	○	ON	×	○	○
Red	Flash Yellow	On	On	AC adapter	-----	OFF	○	×	×
Blue	Flash Yellow	On	On	AC adapter	×	ON	○	○	○
Green	Flash Yellow	On	On	AC adapter	○	ON	○	○	○

※The Status LED stays off until the product starts up after the power is on.

SD card	Status LED
During recording process	Flash Red

FW update	Status LED
During updating process	Purple



Initialize	Status LED
During initialization process	Flash Blue

◆ AUDIO STATUS LED

Audio	Audio status LED
Audio ON	Blue
Audio OFF	Off

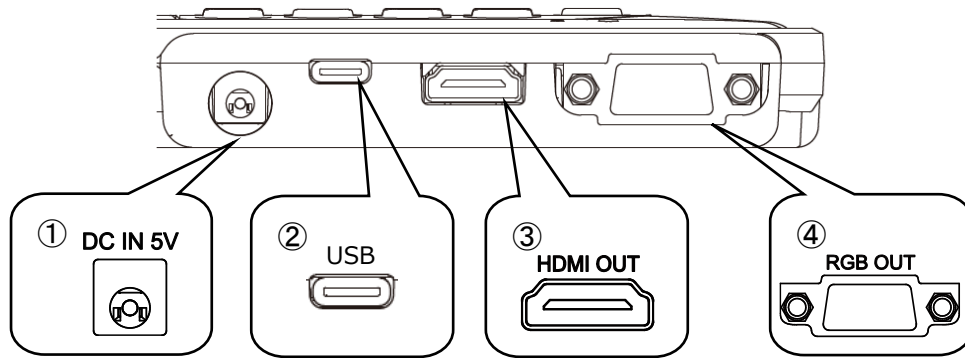
◆ CABLE CONNECTION

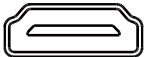
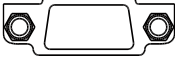

	Mark	Description
①	DC IN 5V 	To connect the supplied DC power cord.
②	USB 	To connect to a computer to save images. Max. resolution: 4 : 3 = 4160x3120 16 : 9 = 3840x2160
③	HDMI OUT 	To output digital images by connecting to a monitor via the HDMI cable. (The HDMI cable is not included.) Max. resolution: 3840x2160
④	RGB OUT 	To output RGB images by connecting to a monitor via the RGB cable. (The RGB cable is not included.) Max. resolution: 1920x1080

◆ SETTING SWITCH

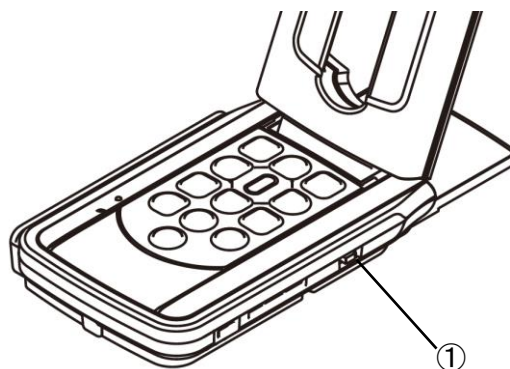

	Mark	Description
①	60 ← → 50	To correct flickers. Select the same value as used for the power supply frequency. (50Hz / 60Hz)

※The change made by the Setting switch will be reflected after the product is turned off and on again.

◆ RESOLUTION / FRAME RATE (WHEN DISPLAYING ON A COMPUTER VIA USB)

The following table shows the output resolution and frame rate when connecting with the TypeC-A cable.

If a low-spec computer is used, the actual frame rate may be slower than what is specified in the table.

Resolution	USB	
	MJPEG[fps]	YUY2[fps]
4160x3120	10	-
3840x2160	30	-
2048x1536	30	-
1920x1080	60/30/15*	-
1280x960	30	-
1280x720	60/30/15*	-
1024x768	30	-
640x480	30	20

*Interactive Whiteboard R1 mode only.

◆ SIZE OF IMAGES BEING OUTPUT

The output resolution is different according to the setting of the Resolution/Output mode selection. The product can output images with the following aspect ratio. Pay attention to the shooting conditions.

RGB output and HDMI output

When HDMI output is possible, both RGB output and HDMI output are output in the same resolution.

*RGB output is not possible when HDMI output resolution is 4K (3840x2160).

OSD settings	NORMAL (16 : 9) / 1080p		FULL (4 : 3) / XGA	
	Yes	No	Yes	No
HDMI connection	Yes	No	Yes	No
RGB output	1080p or 720p	1080 p	1080p or 720p	XGA
HDMI output	4K *RGB out is not possible.		4K *RGB output is not possible.	

Aspect ratio

① FULL(4 : 3)

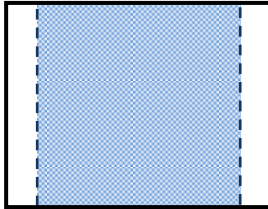

② NORMAL(16 : 9)



	Aspect ratio	
	Normal (16 : 9) / 1080p	Full (4 : 3) / XGA
HDMI	②	①
RGB	②	①
HDMI+RGB	②	①
HDMI+USB	②	
RGB+USB	②	
HDMI+RGB+USB	②	

※Set the USB output resolution to 4K/30fps or 1080p/30fps.
RGB output is not possible when the resolution is 4K.

※The viewing angle of the output image is as follows:

- HDMI out: Normal (16:9) / Full (4:3)
- RGB out only: 1080p/ XGA

※Depending on the condition of the arm, the maximum angle of view that can be captured will change.

※The aspect ratio of the output image is 16:9 when the Viewing angle is set to NORMAL (16:9). Depending on the monitor used, you will see black bars on the top and bottom of the image.

◆ Anti theft lock hole

The product can be secured with a security wire using this hole.
(Size of the hole: 7×3mm)

Anti theft lock hole

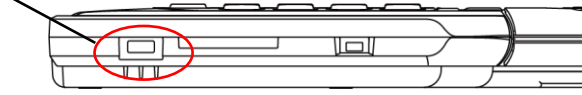

③ PREPARATION AND CONNECTION

◆ SETTING UP

1. Raise the body while holding the operating panel.
2. Raise the arm as indicated by an arrow.
3. Raise the camera head. Set it horizontally.

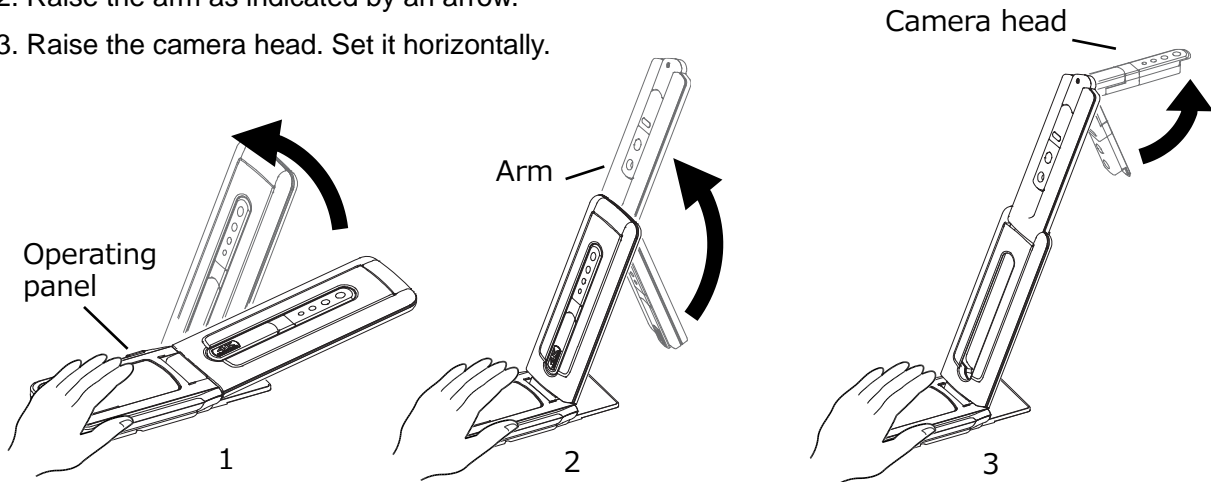

CAUTION

- Be careful not to pinch your fingers when moving the arm.
- Do not hold the arm or camera head when carrying the product.
- Be careful not to give an impact to the camera head.

4. Rotate the camera head according to the shooting direction.

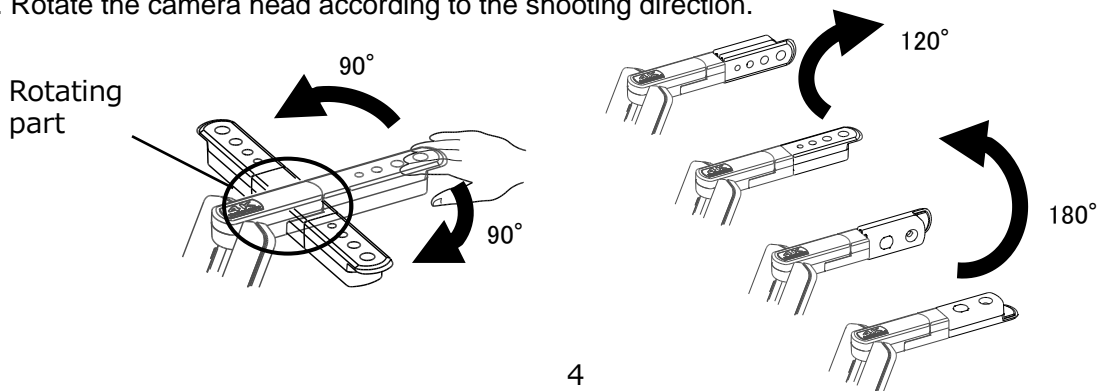

CAUTION

This product uses static electricity sensitive components. In order to avoid malfunction from static electricity, hold the edge of the camera head to rotate the camera head. Do not touch the rotating part.

About the magnet

There is a magnet in the bottom of the product. Using the magnet, you can install the product to various places with metallic surface easily.

CAUTION

If the product is installed to the wall or place which is not level with the magnet, it may fall. Be sure to confirm that the product is installed securely before use.

◆MOVING PARTS OF THE PRODUCT

The product can be moved as shown below.

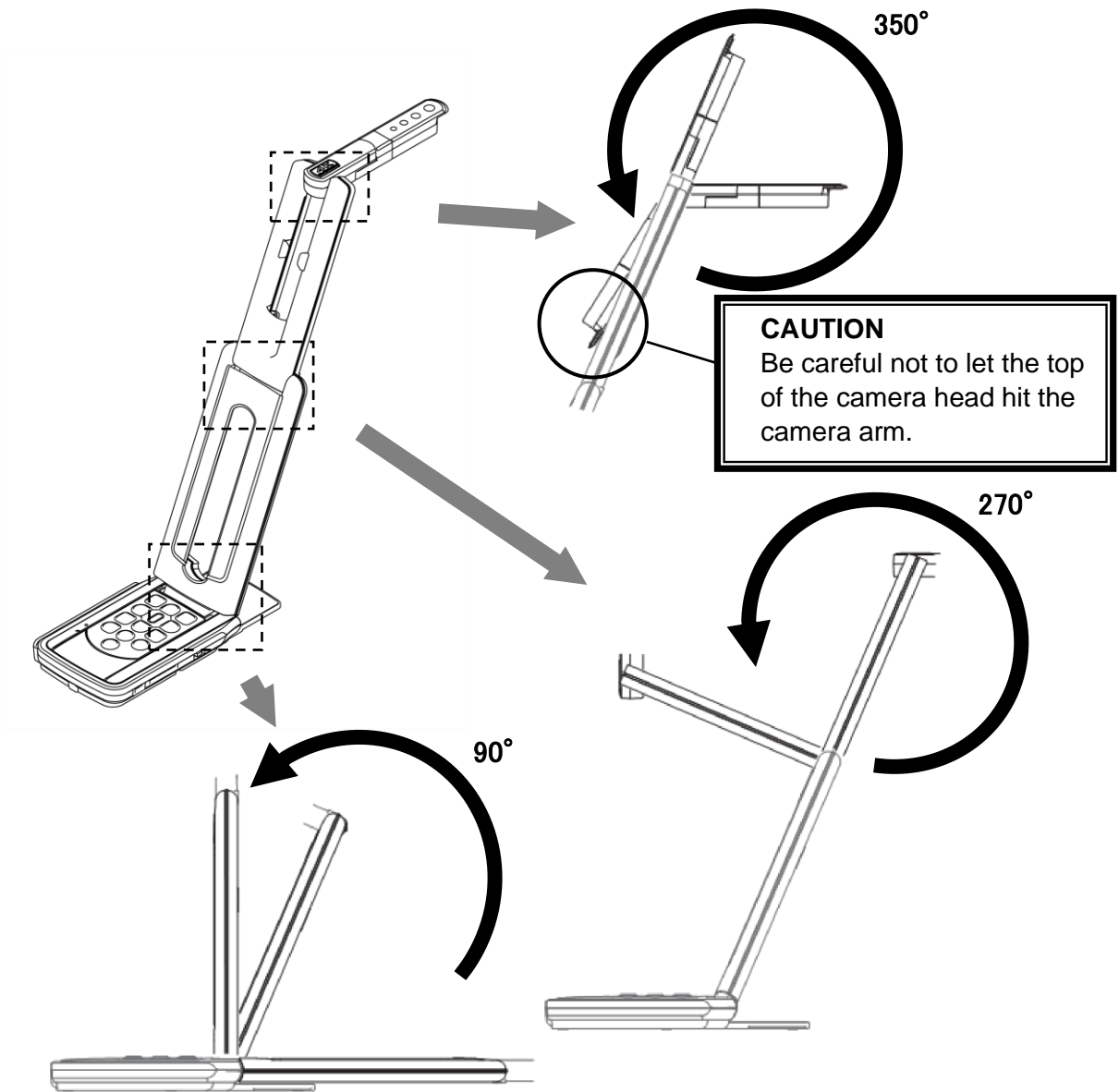

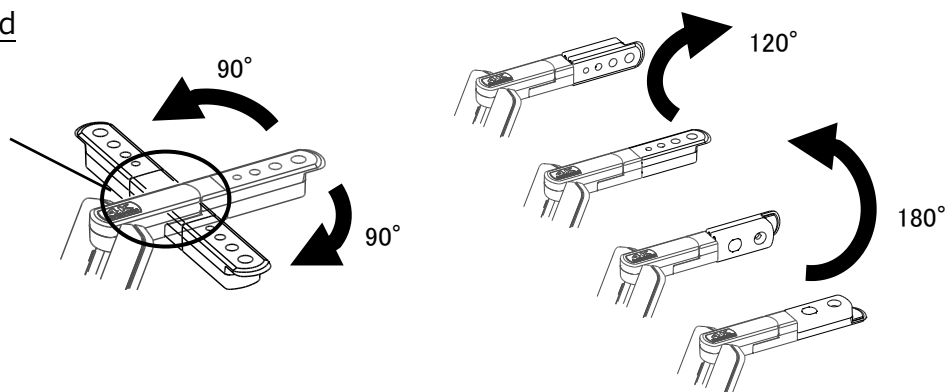

Camera head

Rotating part

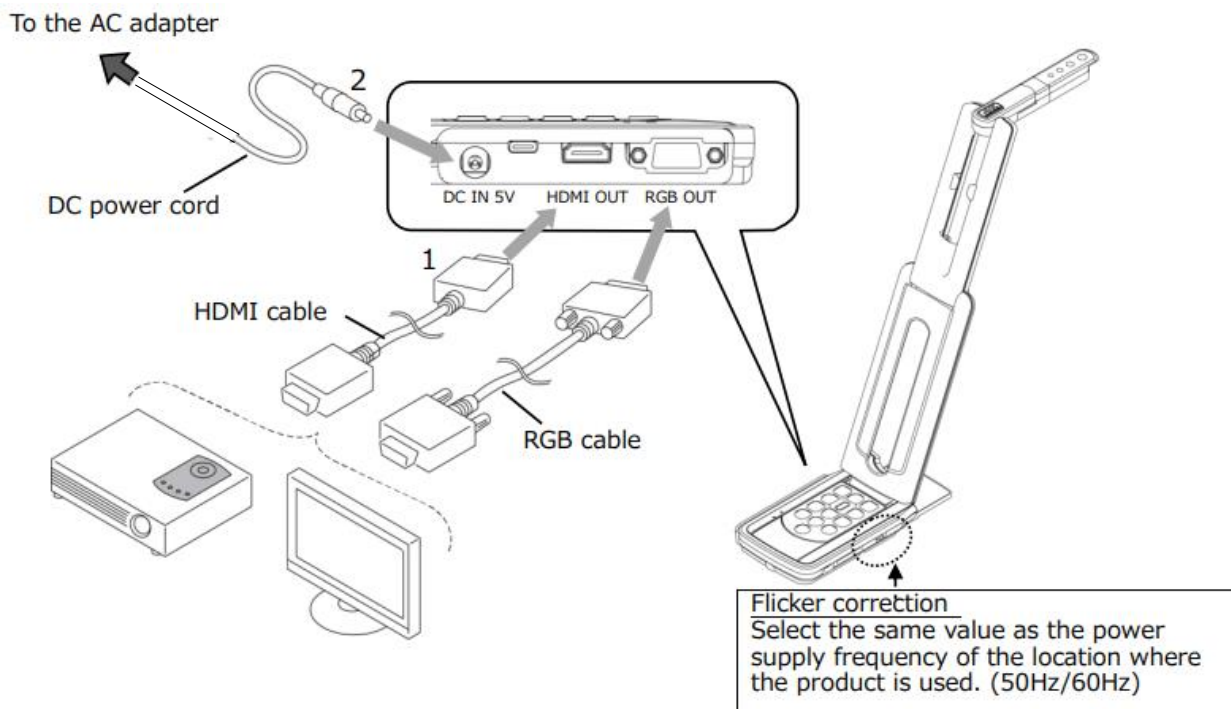

◆CONNECTING TO A PROJECTOR OR MONITOR



1. Connect the product to a projector or monitor with the HDMI cable or RGB cable.
2. Connect the supplied DC power cord to []. Connect the USB plug to the supplied AC adapter. Then connect it to a wall outlet.
3. The product enters the standby status. (Status LED: Red)
4. Press the Power button to turn on the product. The image output will begin.

◆CONNECTING TO A COMPUTER

The product is compliant to UVC (video class) standard. You can transfer the image via USB by connecting the product to a computer using the TypeC-A cable (bus power).

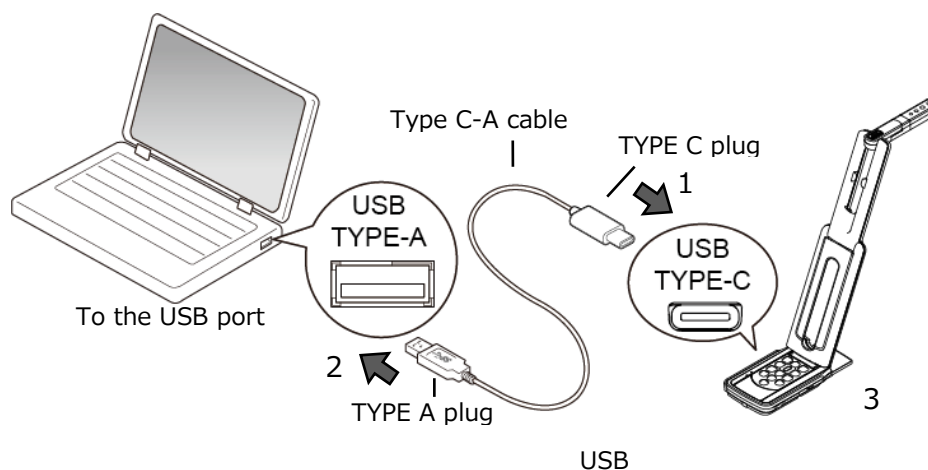



1. Connect the Type C plug of the TypeC-A cable to [] in the side of the product.
2. Connect the Type A plug of the TypeC-A cable to the USB port of your running computer.
3. Set the resolution as described in P.15 using the UVC app.

CAUTION

- The frame rate may be decreased depending on the computer used.
- The performance may be unstable depending on the power supply of the computer. In that case, use the AC adapter to supply the power to the product.

◆CONNECTING TO A PROJECTOR (OR MONITOR) AND COMPUTER SIMULTANEOUSLY

1. Connect the product to a projector or monitor with the HDMI cable or RGB cable.
2. Connect the supplied DC power cord to []. Connect the USB plug to the supplied AC adapter. Then connect it to a wall outlet.
3. Connect the Type C plug of the Type C-A cable to [] in the side of the product.
4. Connect the Type A plug of the Type C-A cable to the USB port of your running computer.
5. The product enters the standby status. (Status LED: Red) The image appears in the UVC app on your computer.
6. Set the resolution to either one of 4K/30fps or 1080p/30fps or 720p/30fps using the UVC app.
7. Press the Power button to turn on the product. Image output to HDMI/ RGB output will begin. (Status LED: Blue)

CAUTION

- RGB output is not possible when the resolution is set to 4K in the UVC app. (HDMI output is possible.) If you want to use RGB output, set the resolution to either 1080p or 720p.
- The frame rate may be decreased depending on the computer used.

4 USING THE PRODUCT

◆ ADJUSTING THE SIZE

The size of the image can be adjusted using [ / ] buttons on the operating panel.

(The size of the image cannot be adjusted if YUY2 format is selected when the product is connected to a computer via the TypeC-A cable.)

The current zoom ratio and operation status do not appear when outputting images to a computer via the TypeC-A cable.

Zoom ratio



NOTE

The maximum zoom ratio is 16x (digital zoom).

The image quality will be degraded when zooming in.

◆ ADJUSTING THE BRIGHTNESS

The brightness of the image can be adjusted using [ / ] buttons on the operating panel. The operation status will appear on the screen.

To initialize the brightness level, press these buttons at the same time.

(The operation status does not appear when outputting images to a computer via the TypeC-A cable.)



◆ ADJUSTING THE FOCUS

Press [] on the operating panel to automatically focus on the subject. The operation status will appear during Auto Focus. (The operation status does not appear when outputting images to a computer via the TypeC-A cable.)



◆ PAUSING THE IMAGE

Press [] on the operating panel to pause the camera image.
Press the button again to restart.
※The Status LED flashes yellow.

◆ ROTATING THE IMAGE

Press [] on the operating panel to rotate the image by 180°.

◆ MIRROR INVERT THE IMAGE

Long Press (about 3 seconds) [] on the operating panel to flipped horizontally the image.



◆ TURNING ON/OFF THE LED LIGHTING

Press [] on the operating panel to turn on or off the LED lighting.

CAUTION

- To take shots of people, turn the LED lighting OFF.
- Make sure that the light from the LED lighting does not shine directly into your eyes.
- This product is equipped with a high-brightness LED. You can safely use it to light up the object. The brightness will gradually decrease with long-term use. This is not a malfunction but a characteristic of the LED.
- Do not touch the LED lighting while it is on as it may become very hot.

◆ TURNING ON/OFF THE AUDIO OUTPUT

By pressing the [] button on the operating panel, you can turn on or off the audio output when the image is output to the computer via USB and SD card video recording audio.
The Audio status LED turns blue [] when the audio output is on.
※There is no audio output to the HDMI output.

◆ SETTING THE CAMERA TO STANDBY STATUS (ONLY AVAILABLE WHEN USING DC POWER CORD)

Press the [] button on the operating panel to enter the standby status.
In the standby status, no image will be output from the HDMI OUT or RGB OUT.
※The image will be output regardless of the Power button status (ON/OFF) when the product is connected to a computer via UVC.

5 RECORDING CAMERA IMAGES

You can record camera images to an SD card as a still image or as a video.

Insert an SD card (SD/SDHC, commercially available) into the SD card slot before recording.

※Recording is not possible without inserting an SD card.

- Video recording: H.264
- Still image recording: JPEG

◆VIDEO RECORDING

Press the Record button [] on the operating panel to start video recording to an SD card. Press the Record button again to stop video recording

Start video recording Status LED flashes red

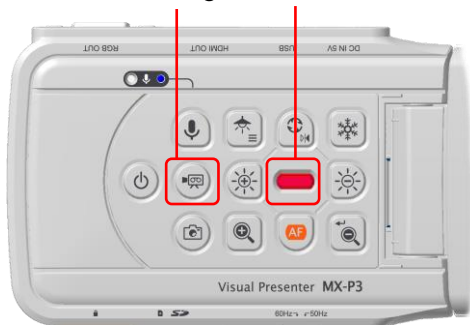

~During recording~

Icon for video recording



~During recording~

※Video recording is not possible when outputting images to a computer via the TypeC-A cable.

(An icon [] appears on the top left of the screen, indicating that recording is not possible.)

Use the viewer software to record the image.

◆STILL IMAGE RECORDING

Press the Capture button [] on the operating panel to save a still image to an SD card.

※The Status LED flashes red for a short time and an icon appears on the top left of the screen.

Save a still image Status LED flashes red

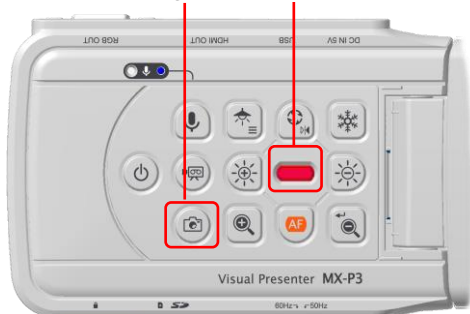

Icon for still image recording



NOTE





About SD card

- SDXC card cannot be used with the product.
- Format the SD card with the product before using it.
- Use an SD card of 32GB or less and class 10 or higher.

6 CONFIGURING THE SETTINGS

Each setting of the product can be configured through the menu displayed on the screen (HDMI/RGB/USB).

◆ HOW TO CONFIGURE THE SETTINGS

1. Long press (for about 2 seconds) the Lighting/MENU button [] on the operating panel to display the Settings menu.
2. Move the cursor with the Image rotation button [] and the One-push AF button []. Then press the ZOOM-OUT button [] to confirm.



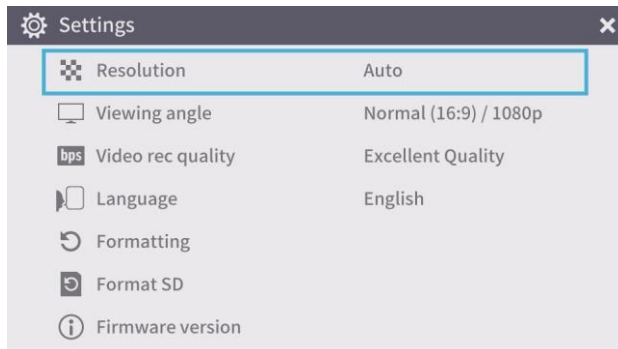

◆ SETTINGS MENU

The following Settings menu appears on the screen. The items in the blue frame are items currently selected with the cursor.



1. Resolution (HDMI)

(The one with the check mark [] is the currently selected item.)

(The resolution setting can also be changed by pressing the Brightness – button [] and the ZOOM-OUT button [] on the operating panel at the same time.)



※The resolution setting cannot be configured when the product is connected to a running computer via the TypeC-A cable.

Name	Selection item	Default setting	Function
Resolution	Auto	✓	To set the resolution of the output image.
	HD (1280×720)		
	FHD (1920×1080)		
	UHD (3840×2160)		

2. Viewing angle



※The viewing angle setting cannot be configured when the product is connected to a running computer via the TypeC-A cable.

Name	Selection item	Default setting	Function
Viewing angle	Normal (16:9) /1080p	✓	To set the viewing angle of the output image. •HDMI out: Normal/ Full •RGB out only: 1080p/ XGA
	Full (4:3) /XGA		

3. Video recording quality

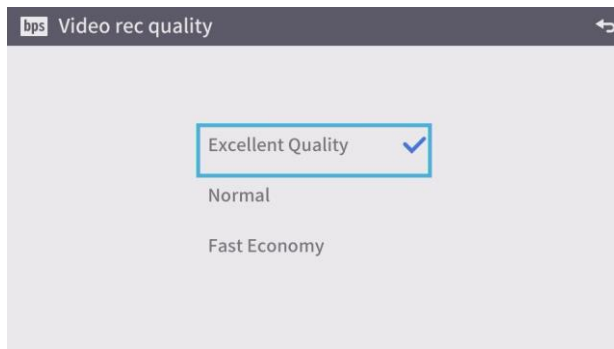

Name	Selection item	Default setting	Function
Video recording quality	High		To set the video quality for the video recording. When “High” is selected, the recording time becomes shorter.
	Normal	✓	
	Long-time (Low)		

4. Language



Name	Selection item	Default setting	Function
Language	Japanese		To set the display language for the product.
	English	✓	
	Deutch		
	francais		
	Chinese		

5. Formatting

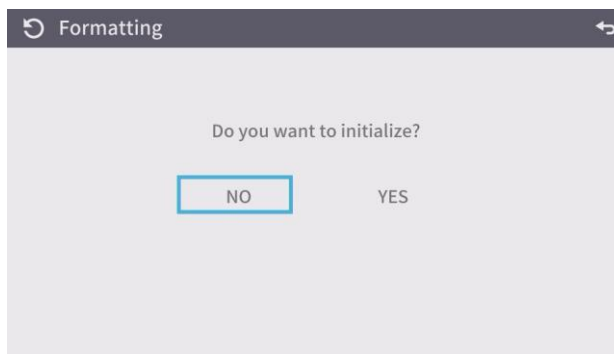

Name	Selection item	Default setting	Function
Formatting	YES		When "YES" is selected, the product will be reset to factory default settings.
	NO	✓	

6. Formatting SD

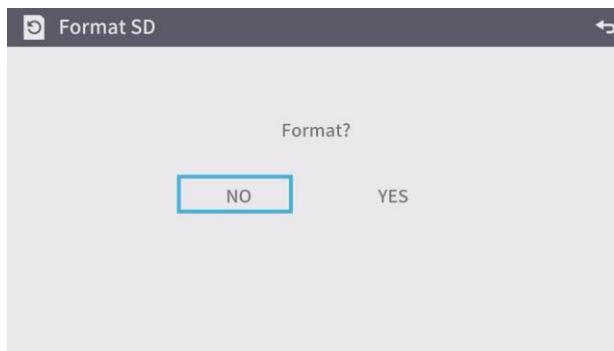



Name	Selection item	Default setting	Function
Formatting SD	YES		When "YES" is selected, the SD card will be formatted.
	NO	✓	

7. FW version



To display the version of the firmware of the product.

7 FW UPDATE PROCEDURE

1. Download the FW from the following website and save the FW (*fex, uImage) to the SD card.
(Save it to the top level of the SD card, no other files, etc.)
<https://www.elmoeurope.com/index.php/en/download-service/firmware-updates>
2. Insert the SD card into MX-P3.
3. Connect the AC adapter and confirming that the status LED is lit in red,
press t [] button and [] button at the same time.
4. The Status LED turns purple.
5. The FW update will begin. The product will automatically restart in 1 minute.
6. The Status LED turns red.
7. The FW update is complete.

8 ABOUT VIEWER SOFTWARE

●Image Mate +C

The following operations can be performed by accessing the WEB app “Image Mate +C” on the internet after connecting the product to a computer via the TypeC-A cable:

- Saving videos and still images to a computer
- Drawing on the image
- Operating the product from a computer (such as zoom, freeze and image rotation)

For details about how to access the “Image Mate +C” and other information, visit the following website.

<https://www.elmoussa.com/imagematecloud/>

●Image Mate 4 (Ver.4.02 Or later)

The following operations can be performed by connecting the product to a computer with Image Mate 4 installed via the TypeC-A cable:

- Saving videos and still images to a computer
- Operating the product from a computer, etc.

※If Image Mate 4 is already installed in your computer, update the version of Image Mate 4.

※You can view the camera image with a commercially available software. With Image Mate 4, you can also use other functions such as zoom and freeze.

For details of the control software Image Mate4 and its instruction manual, visit the following website.

<https://www.elmoeurope.com/index.php/en/products/software-choice/elmo-image-mate-4>

●EIT (Win:Ver.3.17 Or later, Mac:Ver.3.13 Or later)

The following operations can be performed by connecting the product to a computer with our touchscreen electronic blackboard software “EIT (ELMO Interactive Toolbox)” installed via the TypeC-A cable and by connecting the computer to a large monitor or tablet computer:

- Operating the product or enlarging the computer screen
- Drawing on the image
- Saving videos and still images to a computer

For details of the EIT (ELMO Interactive Toolbox), visit the following website.

<https://www.elmoussa.com/software/>

<https://www.elmoeurope.com/index.php/en/products/software-choice/elmo-interactive-toolbox>

NOTE

- If your computer does not meet the recommended requirements or depending on the performance of your computer, the recording frame rate may be decreased.
- Depending on the computer's USB environment or the peripheral equipment, image transfer may be disrupted.
- We do not guarantee the operation of all types of devices with the product.

◆ INSTALLING THE SOFTWARE

You need to install the software to your computer to use “Image Mate 4” or “EIT (ELMO Interactive Toolbox)”.

Access the respective website described above.

※If the software is already installed in your computer, update the version of the existing software.

CAUTION

- Do not connect/disconnect the TypeC-A cable while operating the product . It may cause malfunction.
- We recommend using the supplied TypeC-A cable.
- It may take some time to display the image after the resolution is changed via UVC (with the TypeC-A cable). Do not turn off the power of the product or disconnect the TypeC-A cable before the image is displayed.
- The displayed image may pause for a brief second when the object moves quickly. This is not a malfunction.
- The displayed image may be distorted depending on the object being displayed.





The image distortion may be improved by the following measures:

- Reduce the resolution
- Reduce the frame rate
- Changing image format to MJPEG
- Reducing sharpness or brightness in the camera setting

9 TROUBLE SHOOTING

◆ SYMPTOMS AND POSSIBLE CAUSES/REMEDIES

Check the following items. If any abnormality is found, consult the dealer from whom you purchased this product or our nearest branch/office.

Symptom	Possible cause/ remedy
No image is displayed.	<ul style="list-style-type: none"> • The cable is not correctly connected. • The DC power cord is disconnected from the power supply socket of the product. • The AC adapter is disconnected from the outlet. • The zoom is in the TELE position, displaying only the white or black part of the document. • If you turn the power ON immediately after turning it OFF, the product may not start. Wait for several seconds after turning the power OFF, and then turn it back ON. • The TypeC-A cable is disconnected. • The output setting does not match the cable connected to the unit. Set the correct output setting. • Reconnect the AC adapter and the power cord. • The monitor is not turned on. • The input source of the monitor is not set correctly. • The viewer software is not started correctly. Restart the software and try to connect again. • The product is not selected in the setting of the viewer software.
The output image (resolution) changes automatically.	<ul style="list-style-type: none"> • When the HDMI monitor is connected to the product, the output image (resolution) is automatically changed based on information from the connected monitor.
The image is out of focus.	<ul style="list-style-type: none"> • The document (subject) is too close to the lens. Move the document (subject) slightly away from the lens. • Press the One-push AF button [] on the operating panel.
The image is too dark.	<ul style="list-style-type: none"> • The intensity of the lighting is insufficient. Press the button [] on the operating panel to adjust the brightness. Or press the button [] to turn on the LED lighting.
The image does not move.	<ul style="list-style-type: none"> • Camera image is paused by pressing the [] button on the operating panel. Press the [] button again to restart the image. • Camera image is paused by selecting Freeze function in the viewer software. Check the software and release the freeze. • Reconnect all the cables.

The image is striped.	<ul style="list-style-type: none"> • This may be interference fringes between dots of printed matter and TV scanning lines or CMOS pixels. Changing the shooting range may help the problem. • If you shoot a monitor screen that is displaying a live video, the image may be distorted. • Vertical stripes may appear on an LCD projector image. Manually adjusting the dot clock at the projector side may help the problem. • Vertical stripes may appear when the shooting environment is dark. Brightening the environment may reduce vertical stripes.
The UVC video stream is upside down.	<ul style="list-style-type: none"> • Check that the graphics driver and other device drivers on your computer are updated. The latest device drivers are available from the computer manufacturer.
The displayed UVC image contains images other than the camera image	<ul style="list-style-type: none"> • The software and OS you are using or the connection status may be causing images other than the camera image to breakthrough while displaying the camera image. This problem can be solved by reconnecting the product or restarting the software.
A software error message appears and the UVC image is not displayed	<ul style="list-style-type: none"> • If it is taking too much time for the preparation of the image output, the software may determine this to be an error. Restart the product, reconnect it to the computer, and then start the software.
The UVC image fails to be output.	<ul style="list-style-type: none"> • Disconnect the TypeC-A cable, restart the software, and then connect the TypeC-A cable again.
The UVC video stream sometimes freezes.	<ul style="list-style-type: none"> • The displayed image may pause for a brief second when the object moves quickly. In that case, adjusting the brightness manually may improve the problem.
There is a distortion of the UVC image.	<ul style="list-style-type: none"> • Use a high-spec computer. Also, reducing the resolution or frame rate may improve the distortion of the image.
4K image cannot be displayed with UVC.	<ul style="list-style-type: none"> • The system requirements to display 4K image are as follows: CPU : Intel® Core™ i7 3GHz or higher Memory : 16GB or higher Graphic board : GeForce GTX750 or higher

About the light (LED lighting)

The brightness of the LED lighting will diminish with long-term use. If its brightness has significantly diminished, consult the dealer from whom you purchased this product or our nearest branch/office for replacement (subject to charge).

About long-term usage of this product

Due to the lifetime of its parts, if this product is used for longer than the warranty period, its performance and quality may deteriorate. In this case, we will replace the parts for a charge. Consult the dealer from whom you purchased this product or our nearest branch/office.

10 SPECIFICATION

◆ MAIN CAMERA

Item	Specifications
Power source	DC5V
Power consumption	2.5W (when connecting USB) 6.0W (when connecting HDMI/RGB)
Outside dimensions	W: 343 mm D: 82 mm H: 302mm (When setup)
	W: 290 mm D: 82 mm H: 22mm (When folded)
Weight	Approx. 460g (Main body only)
Ext. control terminal	USB2.0 Type C × 1
Lens	F=2.0
Frame rate	60fps (in high frame rate mode at 1080p)
Focus working range	From lens surface: 100 mm ~ ∞
Focus	Auto (One-push)
Exposure	Auto (Possible to adjust exposure level)
Image pick-up element	1/3.1 inch CMOS 13,000,000 pixels
Effective pixels	H: 4160, V: 3120
Resolution	H: 1300 TV lines or more V: 1300 TV lines or more
Digital zoom	Max. 16x
Imaging area	374 mm × 281 mm (Height: 286 mm) 4:3
HDMI resolution	4K (2160p), 1080p, 720p
RGB resolution	1080p, XGA
Simultaneous output	Possible from each port (USB/HDMI OUT/RGB OUT)

◆ FUNCTIONAL SPECIFICATION

Item	Specifications	Operating panel	IM+ C	IM4	EIT
Brightness adjustment	Possible (Settable in 7 levels) Default setting: 9	✓	-	✓	✓
Image rotation	0°/180° Default setting: 0° (The image rotation function is not available when the image freeze function is used.)			✓	
LED lighting	ON/OFF Default setting: OFF	✓	-	-	-
AF (focus)	Manual (One-push)	✓	-	-	-
Zoom	Possible (from x1 to x16) Default setting: x1			✓	
Image pause	Possible			✓	

Resolution	Manual	-	-	✓	✓
Flicker correction	60Hz / 50Hz (Default setting: 60Hz)	✓	-	✓	✓
Contrast adjustment	Possible (Settable values: 0~20) Default setting: 10	-	-	✓	✓
Hue adjustment	Possible (Settable values: -180 ~ 180) Default setting: 0	-	-	✓	✓
Saturation adjustment	Possible (Settable values: 0~31) Default setting: 10	-	-	✓	✓
Sharpness adjustment	Possible (Settable values: 1~15) Default setting: 5	-	-	✓	✓
White balance	Auto/Manual (Settable values: 2000~8000) Default setting: Auto 6500	-	-	✓	✓
Initialization	Possible	✓※ 1	-	✓	✓

※1 Initialization can be done either by using the Initialization menu or by connecting the product to your computer via the TypeC-A cable while pressing the Lighting/MENU button and the Freeze button at the same time.

(The items that can be reset are: Brightness, Image rotation, Contrast, Hue, Saturation, Sharpness, White balance, AF)

◆ ILLUMINATION DEVICE

Item	Specifications
LED lighting	White LED

◆ OTHER SPECIFICATIONS

Item	Specifications
Recording	SD card 32GB or less, Class 10 or higher
USB	USB 2.0 compliant
Transfer speed	USB2.0 High Speed (480Mbps) ※The actual transfer speed may vary depending on the performance of your computer and the status of the USB bus.
Audio	Built-in microphone Sensitivity: -36dB±3dB Frequency: 100Hz~10KHz
Operating temperature	0°C~+40°C
Humidity	30%~85% (No condensation)

■ TRADEMARKS AND LICENSES

ELMO, Image Mate, and ELMO Interactive Toolbox are the registered trademarks of TECHNO HORIZON CO., LTD.

HDMI, **HDMI**™ logo and High-Definition Multimedia Interface are trademarks or registered trademarks of HDMI Licensing Administrator, Inc.

Windows and/or other Microsoft products referenced herein are either registered trademarks or trademarks of Microsoft Corporation in the United States and/or other countries.

Intel is a trademark or registered trademark of Intel Corporation or its subsidiaries in the U.S. and/or other countries.

GeForce is a trademark or registered trademark of NVIDIA Corporation.

All other company/product names described in this manual are trademarks or registered trademarks of their respective companies.

This product is licensed under the AVC Visual Patent Portfolio License (AVC Video) for the personal and non-commercial use of a consumer to (i) play AVC Video that was recorded by a consumer engaged in a personal and a non-commercial activity and/or, (ii) play AVC Video that was obtained from a video provider licensed from MPEG-LA, LLC. Additional information including that relating to promotional and commercial uses may be obtained from MPEG-LA, LLC.

ATTENTION

- Unless used for personal use, it is prohibited by copyright law to record slides, books and photos without the prior consent of copyright holder.

- This product is designed to be used in industrial environment. If it is used in a residential area or in an adjacent area thereto, harmful interference to radio or television reception may occur.

- Repair parts

Repair parts are the items which are needed to maintain product functionality. The holding period of such repair parts is 5 years after the product discontinuation, which is equal to the repair period we will accept.

- Any image, which is obtained by this product, and which can be identified, is considered to be private information. Be forewarned that the person who makes use of such images shall be liable for disclosing of such images.

テクノホライゾン株式会社

〒457-0071

愛知県名古屋市南区千竈通二丁目 13 番地 1

<https://www.elmo.co.jp>

OVERSEAS SUBSIDIARIES

ELMO USA CORP.

Headquarters
6851 Jericho Turnpike
Suite 145
Syosset, NY 11791
Tel. (516) 501-1400
Fax.(516) 501-0429
E-mail : elmo@elmousa.com
Web : <https://www.elmousa.com/>

ELMO Europe SAS

Headquarters
60, av. Charles de Gaulle
92200 Neuilly - sur - Seine
FRANCE
Tel. +33 (0) 1 73 02 67 06
Fax. +33 (0) 1 73 02 67 10
E-mail : info@elmoeurope.com
Web : <https://www.elmoeurope.com/>

German Branch
Monschauerstr. 1
40549 Düsseldorf
Tel. +49 (0) 211 544756 40
Fax. +49 (0) 211 544756 60
E-mail : info@elmo-germany.de
Web : <https://www.elmo-germany.de/>

Middle East Branch
5WA-129, Dubai Airport Free Zone,
P.O Box 371556, Dubai,
United Arab Emirates
Tel. +971-(0)4-260-2390
Fax. +971-(0)4-260-2392
Web : <https://www.elmoeurope.com>

TECHNO HORIZON CO., LTD.

2-13-1, Chikamatori Minami-ku
Nagoya, 457-0071, Japan