



# SMART Heavy Duty Mobile Stand

for interactive displays

## User guide

FS-SBID-200 | S200-1



Was this document helpful?  
[smarttech.com/docfeedback/171822](https://smarttech.com/docfeedback/171822)

**SMART**<sup>®</sup>



## Learn more

This guide and other resources for FS-SBID-200 are available in the Support section of the SMART website ([smarttech.com/support](https://smarttech.com/support)). Scan this QR code to view these resources on your mobile device.

### **Trademark notice**

SMART Board, smarttech, the SMART logo and all SMART taglines are trademarks or registered trademarks of SMART Technologies ULC in the U.S. and/or other countries. All third-party product and company names may be trademarks of their respective owners.

### **Copyright notice**

© 2022 SMART Technologies ULC. All rights reserved. No part of this publication may be reproduced, transmitted, transcribed, stored in a retrieval system or translated into any language in any form by any means without the prior written consent of SMART Technologies ULC. Information in this manual is subject to change without notice and does not represent a commitment on the part of SMART.

This product and/or use thereof is covered by one or more of the following U.S. patents:

[www.smarttech.com/patents](https://www.smarttech.com/patents)

May 2, 2022

### **Address**

3636 Research Road NW  
Calgary, Alberta, Canada  
T2L 1Y1

# Important information

## Note

Refer to the [illustrated installation instructions](#) for important information about installing and setting up the stand.

## Warning

- Read the following warnings carefully. Failure to read the warnings below or to follow the installation instructions included with your SMART product could result in **personal injury or product damage**, and may result in a voiding of warranties for this product and/or product subsequently mounted on it.
- The assembly and installation of this product is intended for a trained professional.
- The installer must follow the instructions in the installation guide. Not doing so can result in injury or damage to equipment.
- Use only SMART-supplied mounting hardware or hardware that is designed to properly support the weight of your product.
- CAUTION – Use the FS-SBID-200 stand only with displays with diagonal measurements that range from 55" (140 cm) to 86" (218 cm) and that weigh between 92.4 lb. (42 kg) and 265 lb. (120 kg). Using the stand with other displays might be unstable and could result in injury.
- The maximum allowed weight of accessories that can be placed on the accessory tray is 11 lb. (5 kg).
- The maximum allowed weight of accessories that can be placed on the base is 22 lb. (10 kg).
- Do not use the handles to lift the stand.
- Do not operate the SMART product if it is damaged.
- Do not allow children to operate or play with the SMART product.
- **WARNING** – Death or serious injury may occur when children climb on audio and/or video equipment furniture. A remote control or toys placed on the furnishing may encourage a child to climb on the furnishing and as a result the furnishing may tip over on to the child.
- Do not stand (or allow children to stand) on a chair to touch the surface of your SMART product. Rather, mount the product at the appropriate height.

## SMART Heavy Duty Mobile Stand

- **WARNING** – Relocating audio and/or video equipment to furniture not specifically designed to support audio and/or video equipment may result in death or serious injury due to the furnishing collapsing or over turning onto a child.
- Ensure that any cables extending across the floor to your SMART product are properly bundled and marked to avoid a trip hazard.
- Do not move the floor stand while external cables are connected or when the power is on.
- Secure all cords and cabling before you move the floor stand.
- Two or more people are required to move the floor stand.
- Move a floor stand-mounted SMART Board with care. Quick stops, excessive force and uneven surfaces may cause the product to overturn.
- Use only original accessories and replacement parts. Using other accessories or parts will void the warranty/guarantee.
- This product may contain substances that are candidate SVHCs under the EU REACH Regulation (EC) 1907/2006. Check <https://echa.europa.eu/scip-database> for the latest information.
- This stand is intended for institutional / school use.
- In no event shall SMART Technologies ULC or its affiliates have any liability to the end user or any other person or entity for damages of any kind arising from a failure to properly follow the installation instructions, including these safety instructions.

# About the stand's load-bearing surfaces

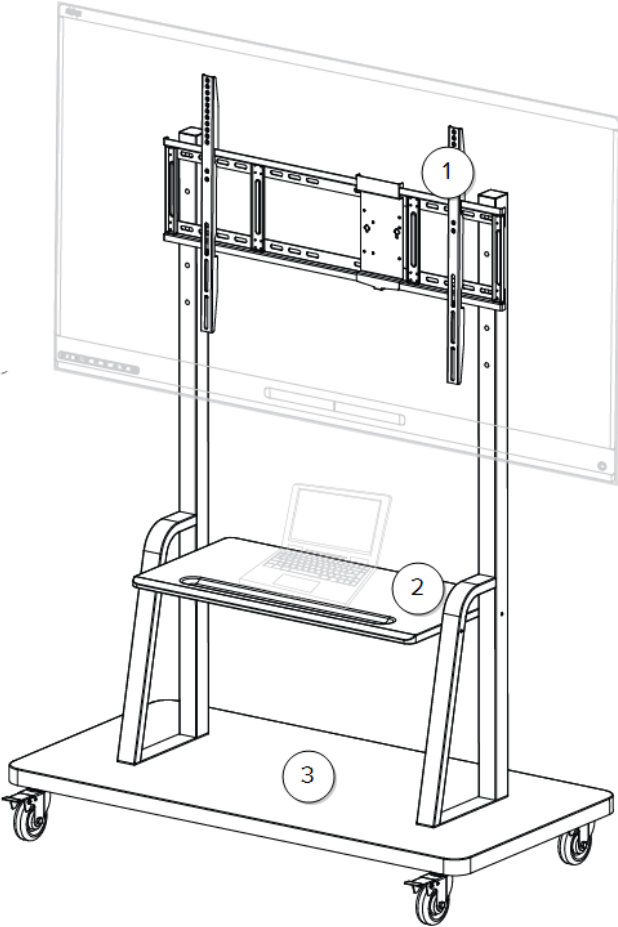

Number	Maximum load
1	265 lb. (120 kg)
2	11 lb. (5 kg)
3	22 lb. (10 kg)

# Assembling the stand

Tools the assembler needs to supply:

- Phillips No. 2 screwdriver
- Phillips No. 3 screwdriver
- 13 mm wrench or socket
- 17 mm wrench or socket
- 3 mm hex key

## To assemble the stand

Step	Required tools and items	Instructions	Diagram
1	13 mm wrench or socket, caster $\times 4$ , screw $a \times 16$ , and stand base	Flip the stand base upside down. Connect each caster to the stand base using four screws $a$ .	
2	N/A	Flip the stand base back over and lock all four casters.	

# SMART Heavy Duty Mobile Stand

User guide

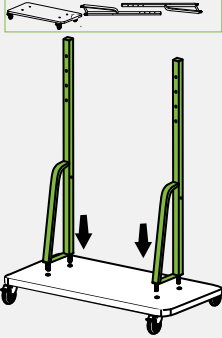
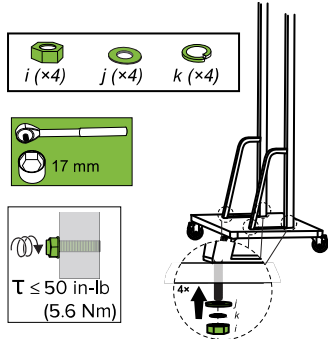
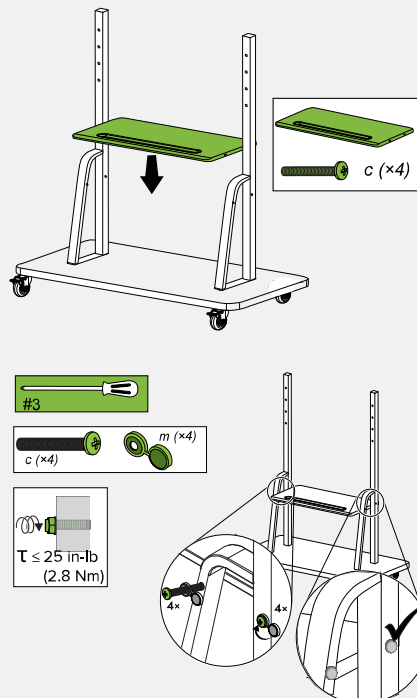
Step	Required tools and items	Instructions	Diagram
3	Support x2 and stand base with casters	Insert the supports into the stand base.	
4	17 mm wrench or socket, washer $j \times 4$ , washer $k \times 4$ , nut $i \times 4$ , and stand base with casters	Secure the four support studs to the bottom of the stand base using washer $j$ , washer $k$ , and then tightening nut $i$ .	
5	Required: Phillips No. 3 screwdriver, screw $c \times 4$ , plastic screw cover $m \times 4$ , shelf, assembled stand base	Insert the shelf between the supports. Insert screw $c$ into the plastic screw cover $m$ , then secure the shelf to the supports using the Phillips No. 3 screwdriver. Snap the cover in place after the screw is tightened. Repeat for the remaining three screws $c$ and plastic screw covers $m$ .	

**SMART Heavy Duty Mobile Stand**

User guide

Step	Required tools and items	Instructions	Diagram
6	13 mm wrench or socket, Phillips No. 3 screwdriver, screw <i>b</i> ×4, washer <i>g</i> ×4, and nut <i>h</i> ×4, bracket	While keeping in mind the height of the users and the size of the display, secure the bracket to the supports. Insert screw <i>b</i> on the front of the mount. Then use washer <i>g</i> and nut <i>h</i> on the rear of the screw. Tighten the nut with the wrench or socket. Repeat for the remaining three screws <i>b</i> .	
7	3 mm hex key, screw <i>d</i> ×1, screw <i>e</i> ×4, and computer mounting bracket	<p><b>Note</b></p> <p>Required only if mounting a computer to the stand</p> <p>Place the computer mounting bracket in the middle of the bracket you installed in <a href="#">Step 6</a>. Using screw <i>d</i> and the hex key, secure the computer mounting bracket to the bracket.</p> <ol style="list-style-type: none"> <li>Use the four screws <i>e</i> to secure a computer, if you are using one.</li> <li>If you have a SMART Board MX or MX Pro series interactive display, see <a href="#">Step 8</a>.</li> </ol> <p>OR</p> <p>If you have a SMART Board 6000S or 6000S Pro series interactive display, see <a href="#">Step 9</a>.</p> <p>OR</p> <p>If you have another type of SMART Board interactive display, go to <a href="#">Step 10</a>.</p>	



# SMART Heavy Duty Mobile Stand

User guide

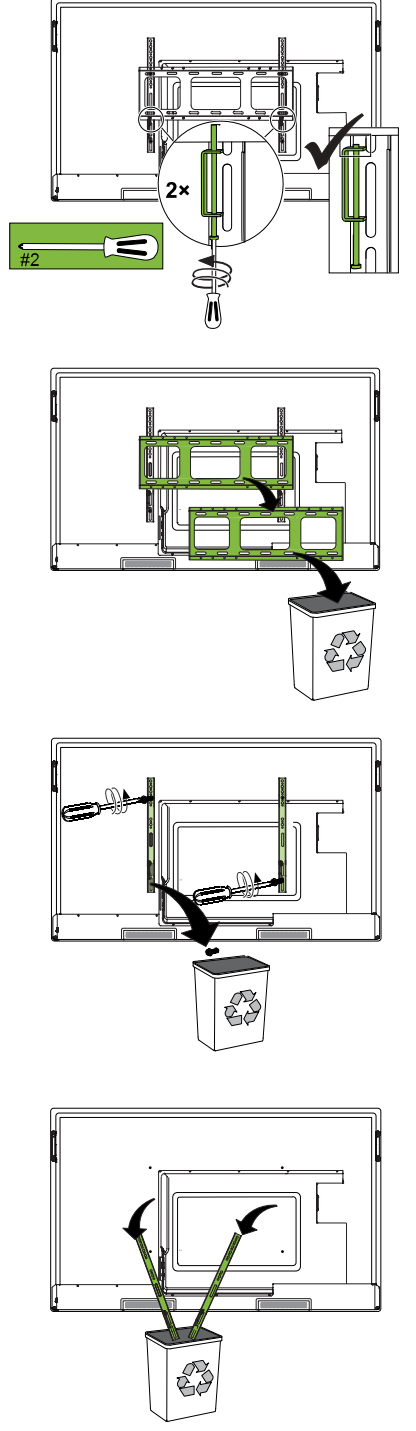
Step	Required tools and items	Instructions	Diagram
8	Phillips No. 2 screwdriver	<p>SMART Board MX and MX Pro series interactive displays</p> <p>Loosen the screws that secure the included bracket to the display and remove the bracket</p> <p>Loosen the screws that secure the vertical brackets to the display and remove the vertical brackets.</p> <p>Proceed to <a href="#">Step 10</a>.</p>	

# SMART Heavy Duty Mobile Stand

User guide

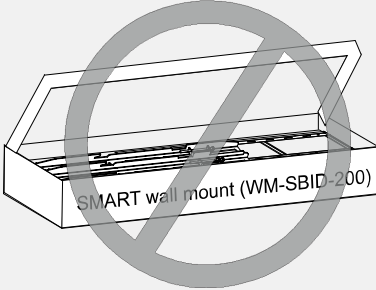
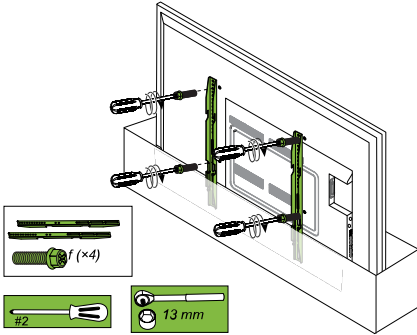
Step	Required tools and items	Instructions	Diagram
9	N/A	<p>SMART Board 6000S and 6000S Pro series interactive displays</p> <p>a. Do not attach the SMART wall mount (WM-SBID-200) to the SMART Board 6000S and 6000S Pro series interactive displays.</p>  <p>b. Proceed to <a href="#">Step 10</a>.</p>	N/A
10	Vertical bracket ×2, screw <i>f</i> ×4, Phillips No. 2 screwdriver or 13 mm wrench or socket, and SMART Board interactive display (this stand is designed for SMART Board 6000S, 6000S Pro, MX, MX Pro, and GX series interactive displays).	Using screws <i>f</i> and the Phillips No. 2 screwdriver or 13 mm wrench or socket, attach the two vertical brackets to the back of the display.	

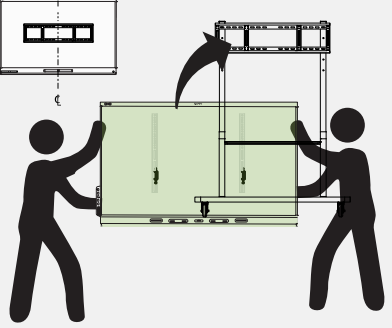
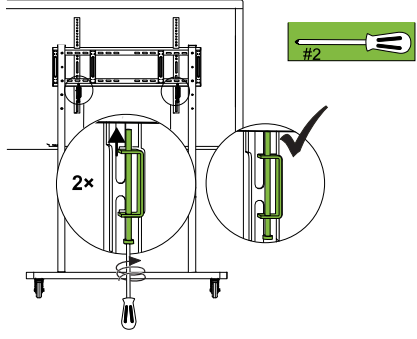

# SMART Heavy Duty Mobile Stand

User guide

Step	Required tools and items	Instructions	Diagram
11	2 people, a display, and an assembled stand	Place the display onto the stand's horizontal mounting bracket, making sure the display is centered on the bracket.	
12	Phillips No. 2 screwdriver	Tighten the screws that secure the vertical brackets to the stand's horizontal mounting bracket.	

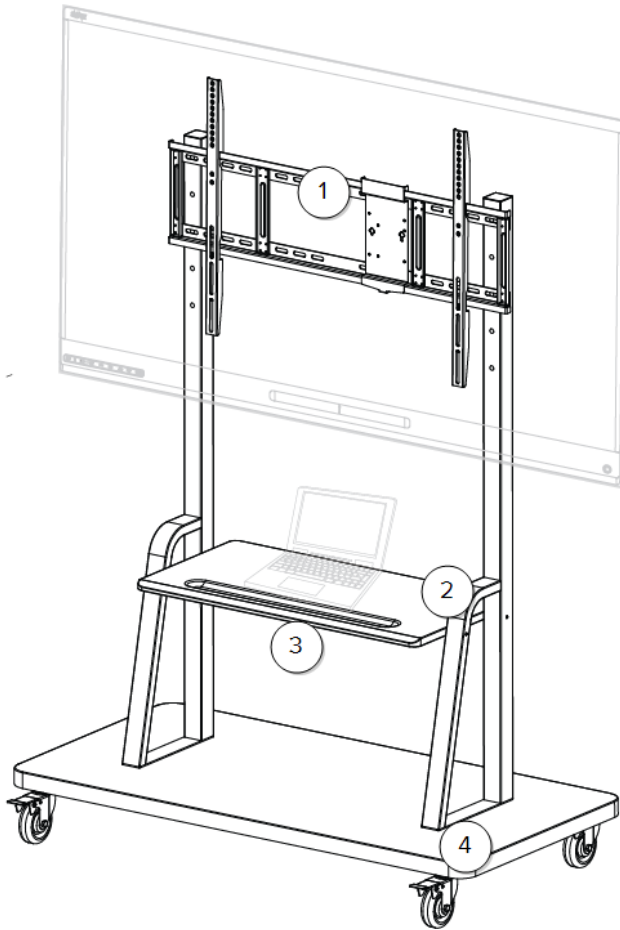

## About the stand's labels



Number	Label	Location
1	 <p><b>WARNING - Risk of Tip Over</b> For use with displays weighing 265 lbs (120 kg) or less. Use with heavier displays may result in instability causing tip over resulting in death or serious injury.</p> <p><b>AVERTISSEMENT - Risque de basculement</b> Pour une utilisation avec des écrans pesant 265 lbs (120 kg) ou moins. Une utilisation avec des écrans plus lourds peut entraîner une instabilité pouvant causer un basculement qui peut entraîner la mort ou des blessures graves.</p>	Center of the upper bracket
2	 <p><b>WARNING - Risk of Tip Over</b> Maximum load of Top Shelf: 11 lbs (5 kg) Maximum load of Base: 22 lbs (10 kg)</p> <p><b>AVERTISSEMENT - Risque de basculement</b> Charge maximale de l'étagère supérieure : 11 lb (5 kg) Charge maximale de la base : 22 lb (10 kg)</p>	Rear right corner of the top shelf

# SMART Heavy Duty Mobile Stand

## User guide

Number	Label	Location
3	 <p><b>FS-SBID-200</b> Regulatory Model: S200-1  <b>SMART Floor Stand</b>  <b>SMART P/N: 1037705</b> Rev: XX          Date of Manufacture: YYYYYW  <b>S/N: VVVQDDDPXXXX</b></p> <p>Assembly instructions can be viewed, downloaded, and printed at          Les instructions de montage peuvent être consultées, téléchargées et imprimées sur  <a href="http://www.smarttech.com/kb/171822">www.smarttech.com/kb/171822</a></p> <p>User guide can be viewed, downloaded, and printed at          Le guide de l'utilisateur peut être consulté, téléchargé et imprimé sur  <a href="http://www.smarttech.com/kb/171822">www.smarttech.com/kb/171822</a></p> <p><b>UL LISTED</b>          E499615          Flat Panel          Display Stand</p> <p>Made in China</p> <p><b>SMART Board</b>  <small>SMART Technologies U.L.C. All rights reserved. SMART Board, the SMART logo and smarttech are trademarks or registered trademarks of SMART Technologies U.L.C. in the U.S. and/or other countries.  <a href="http://smarttech.com/support">smarttech.com/support</a> • <a href="http://smarttech.com/compliance">smarttech.com/compliance</a> • <a href="http://smarttech.com/patents">smarttech.com/patents</a></small></p> <p><b>SMART</b>  <small>SMART Technologies U.L.C.          3636 Research Road NW,          Calgary, AB T2L 1Y1,          CANADA          1037748-01</small></p>	Underside of the top shelf in the center
4	 <p><b>WARNING</b>          CAN TIP OVER RESULTING IN RISK OF INJURY.          DO NOT ALLOW CHILDREN UNDER 16 TO MOVE THE CART.          MOVE THE CART SLOWLY.</p> <p><b>AVERTISSEMENT</b>          PEUT RENVERSER ENTRAINANT UN RISQUE DE BLESSURE.          NE PERMETTEZ PAS AUX ENFANTS DE MOINS DE 16 ANS DE DEPLACER LE STAND MOBILE.          DEPLACER LE STAND LENTEMENT.</p> <p>ONLY ADULTS SHOULD MOVE THIS UNIT          SEULS LES ADULTES DEVRAIENT DEPLACER CETTE UNITE</p> <p>APPLY MOVING FORCE ON NARROW DIMENSION          APPLIQUER UNE FORCE MOBILE SUR UNE DIMENSION ETROITE</p> <p>ALWAYS PUSH NEAR MIDDLE. PUSH. DON'T PULL          TOUJOURS POUSSER VERS LE MILIEU</p> <p>NEVER APPLY FORCE AT TOP          NE JAMAIS APPLIQUER DE PRESSION SUR LE DESSUS</p> <p>DONT PULL. POUSSER NE PAS TIRER</p>	Front right corner of the base

## Maintaining the stand

The stand's mounting system has no user-serviceable parts. All servicing is to be performed by an authorized service representative.

**SMART Technologies**

[smarttech.com/support](http://smarttech.com/support)

[smarttech.com/contactsupport](http://smarttech.com/contactsupport)

[smarttech.com/kb/171822](http://smarttech.com/kb/171822)