

# iDream3

HEAD MASSAGER

---

# USER MANUAL

---



OBM Distribution / Breco-USA  
13900 Sycamore Way  
Chino, CA 91710  
<http://www.brecousa.com>  
[info@brecousa.com](mailto:info@brecousa.com)

**breco**<sup>®</sup>

---

**Thank you for purchasing  
BREO iDream3.**

Please read this manual carefully before using  
the product, and keep it in a safe place for future  
reference.

---

# Contents

---

Introduction	3
Inside the Package	3
Function Deployment	4–5
Preparation	5
Operation	6–8
Precautions	9–10
Troubleshooting	11
Technical Parameters	12
Storage	12

# Introduction

---

The iDream3 adopts air pressure, vibration, and hot compress massaging technology to massage the head and ocular regions. It comes with built-in relaxing music. You can now enjoy wonderful music while massaging, further relaxing your brain.

# Inside the Package

---

The package includes: Main Unit, Controller, Power Charger, Batteries, User Manual, Earphones, USB Cable

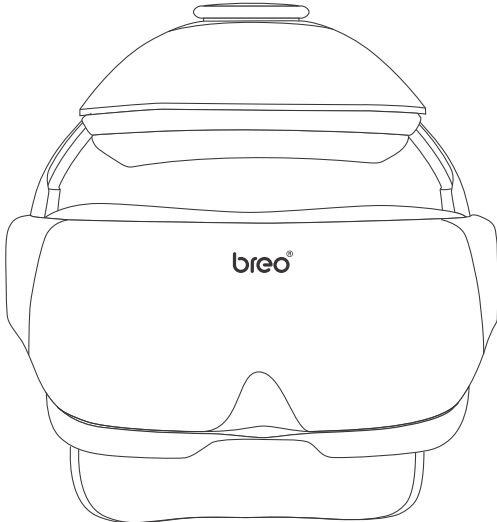

Main Unit

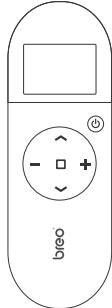

Controller

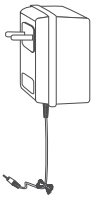

Power Charger



Earphones

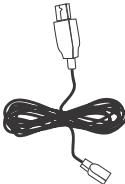

USB Cable



Manual

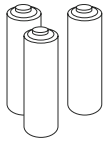

Batteries

# Function Deployment

---

## Main Unit and Remote Control

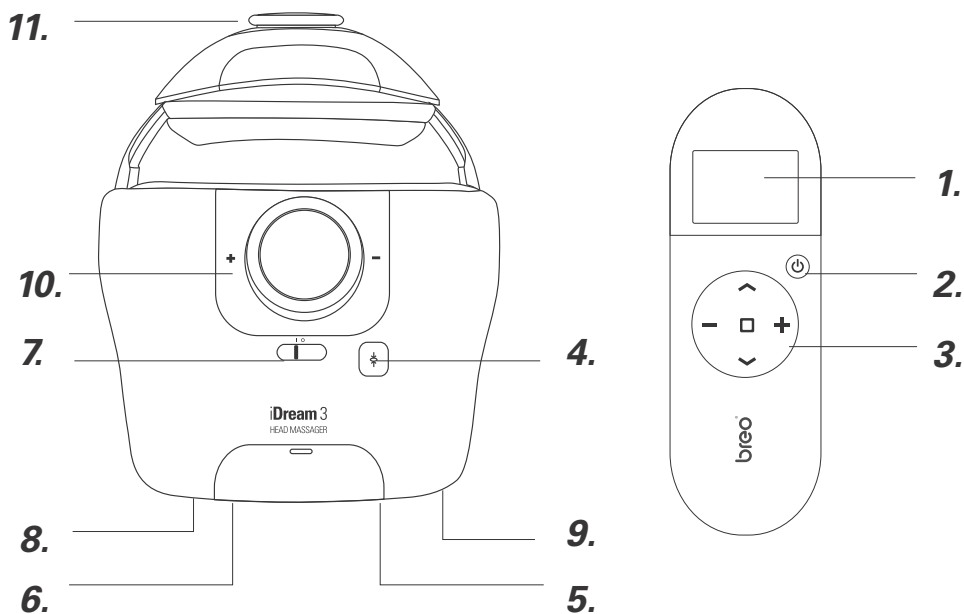

- |                                    |                                       |
|------------------------------------|---------------------------------------|
| <b>1.</b> LCD Screen               | <b>7.</b> Power Switch Protection key |
| <b>2.</b> ON/Off                   | <b>8.</b> Encoding Key                |
| <b>3.</b> Operating Buttons        | <b>9.</b> USB Port                    |
| <b>4.</b> Pressure Reduction Valve | <b>10.</b> Size Adjusting Knob        |
| <b>5.</b> DC Power Port            | <b>11.</b> Tightness Adjusting Knob   |
| <b>6.</b> Earphone Jack            |                                       |

LCD Screen: From top to bottom: Time / Air Pressure / Vibration / Hot Compress / Music

Operating Button: Clockwise: Up Button / Function Mode Next / Down Button / Function Mode Previous



Center: OK Button

Power switch protection key: Push left or right to turn ON/OFF

MUST push power switch to Level "0" after each use

## Attention:

In case of problem with connection between the main unit and remote control, you can perform joint encoding operation:

1. Turn the remote control off, and push the power switch of the main unit to level "0".  
Press and hold [8] encoding key of the main unit. While still holding it, push the power switch of the main unit to level "1" to turn it on. The blue LED indicator on the front of the main unit flashes.
2. Release [8] encoding key, and simultaneously press the  and  keys of the remote control for 2-3 seconds. The remote control LCD lights up while the main unit's blue LED indicator turns off -- it means the encoding is successful (This step should be completed within 6 seconds). If unsuccessful, repeat from the start.
3. Push the power switch of the main unit to level "0", then back to level "1". Both the main unit and remote control should now be working.

Please make sure that one main unit is corresponding to one remote controller. The operation of encoding joint with multiply remote controller to the main unit is prohibited.

Important: Make sure that only one device is paired with the remote control. Multiple pairing of remote control and main unit is strictly prohibited.

## Preparation

---

Prior to use, check the integrity of the machine and accessories.

1. No damage on power charger
2. Battery power is sufficient

# Operation

---

## Charging of Main Unit

1. Open the cover of the DC power port on the main unit.
2. Insert the plug of the power charger to the DC port.
3. During charging, the light of the power charger is red. The light turns green when fully charged.

## Attention:

1. Push the power switch on the main unit to Level "0". Keep the massager turned OFF while charging. Charging time is approximately 3-4 hours.
2. If the massager is turned on while recharging, all functions of the product will run normally. The machine will automatically stop charging to prevent damage to the device.
3. If the power of the battery is lower than  $3.2+0.1V$ , the machine will automatically turn off. If the LED indicator of the main unit flashes, it means the lithium battery is low. Recharge the main unit.

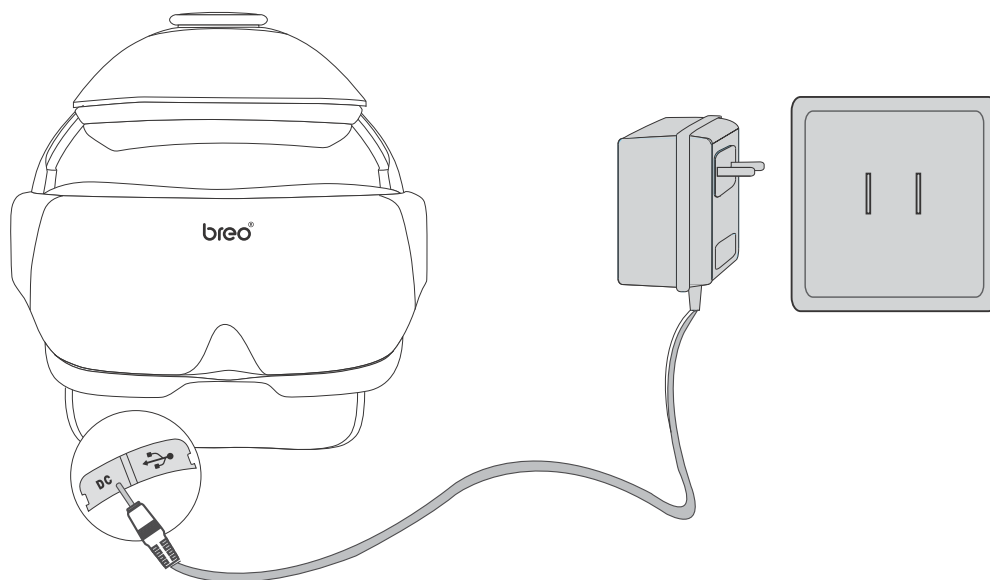

## Music Downloading

1. Connect the main unit to computer using the supplied USB cable;
2. Push the power protection key on the main unit to Level "1".
3. Copy MP3 music to the device.

## Wear

1. Use the back dial to adjust the distance between head to establish the most comfortable fit, and wear main unit.
2. Use the top dial in setting the distance above head.

## Power On

1. Open the battery cover on the back of the remote control.
2. Place 3 AAA batteries in accordance with the positive and negative poles.
3. Close the battery cover. (Picture1)

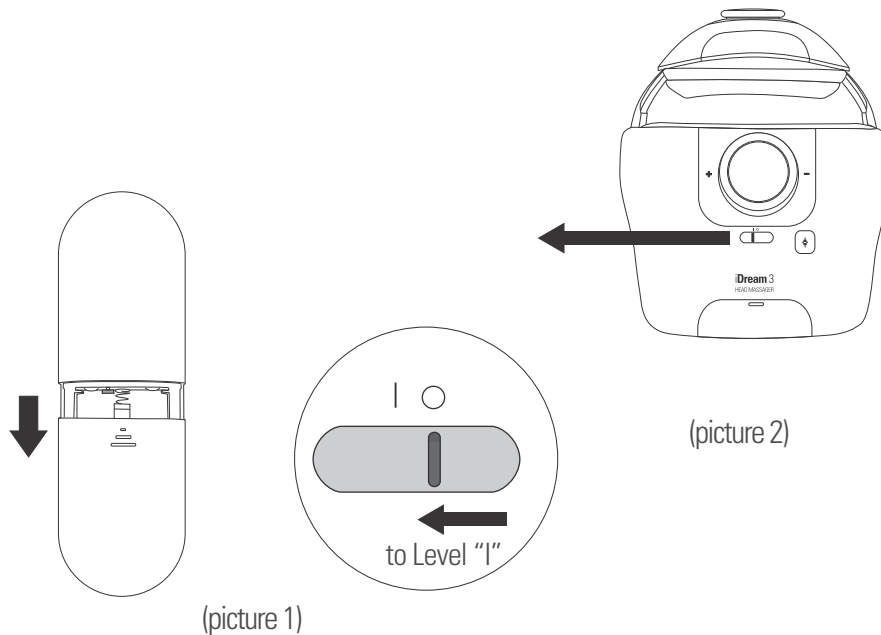



# Operation

---



## Automatic Mode (without remote control)

### Power On/Off

1. Power ON – Push the ON/OFF switch on the main unit to Level “1” (Picture2)  
No need of remote control. The main unit starts working after 8 seconds.  
Preset default is air pressure + heat compression + music + 15 minutes duration.
2. Power OFF – The main unit automatically shuts off after 15 minutes.  
Push the ON/OFF switch on the main unit to Level “0”.

## Manual Mode (using the remote control)

### Power On/Off

1. Power ON: Push the ON/OFF switch on the main unit to Level “1” (Picture2)  
The main unit is powered by a high performance, environment-friendly lithium battery.
2. Press and hold  Button on the remote control  
Preset default is air pressure + heat compression + music + 15 minutes duration  
Default air pressure: Mode 5 – circulates among Modes 1 to 4;  
Default hot compress: low temperature;  
Default Music: Well-being music
3. Power OFF: Press  Button on the remote control.
4. Push the ON/OFF switch on the main unit to Level “0”

Manually operate related buttons to select air pressure mode, vibration mode, hot compress temperature, change music and/or massage duration.

Press  Button to choose among functions

(Time, Air Pressure, Vibration, Heat, and Music)

— Press  Button to turn on/off a function

— Press  Button to select air pressure mode, vibration mode, hot compress temperature, change music and/or massage duration

### Time

— Press  Button to select “Time”

— Press  Button to select massage duration

15 minutes/10 minutes/5 minutes

### Air pressure

— Press  Button to select “Air Pressure”

— Press  Button to select from the 5 different modes of air pressure  
(Preset Default: Mode 5 – circulates among Modes 1 to 4)

— Off/On: Press  Button to turn off/on Air Pressure

### Heat compression

— Press  Button to select “Heat Compression”

— Press  Button to select low temperature or high temperature

— Off/On: Press  Button to turn off/on Heat Compression

### Vibration

— Press  Button to select “Vibration”, then Press  Button

— Press  Button to select from the 5 different modes of vibration

— Off/On: Press  Button to turn off/on Vibration

### Music

— Press  Button to select “Music”, then Press  Button

— Press  Button to go to the next one

(Preset Default – circulates among pre-recorded music)

— Press  Button to go to the previous one

— Press and hold  Button: Volume up

— Press and hold  Button: Volume down

— Off/On: Press  Button to turn off/on Music

— Press and hold  Button to switch over between built-in music and MP3 music

### Attention:

When you feel the air pressure is too much and/or uncomfortable, press the Pressure Reduction Valve on the main unit to release air.

# Precautions

---

1. Please read the manual carefully and operate accordingly.
2. Children under 7 years old cannot use the massager.
3. This massager should not be used by people who suffer from a brain disease, have had brain surgery, or have a physical or mental disorder.
4. Take off contact lenses/eye glasses before use.
5. Put on/wear the unit first BEFORE turning the power on.
6. Do not use while walking or driving.
7. Keep your eyes closed for a few seconds after use, then open them slowly.
8. Keep the massager away from humidity, heat, and/or corrosive gas.
9. If the massager will not be used for a long time, remove the batteries to prevent battery leakage.
10. This massager is designed as a personal care product. It is not for diagnosis/treatment of any health disorder, nor meant for commercial use.
11. This massager features heat compression. Individuals who are incapable of or do not ordinarily feel heat/cold sensation should use this device with caution.
12. To clean, wipe with aseptic cotton and alcohol. Do not wash or immerse in water.
13. This product is not a substitute for healthcare professionals' advice and treatment. In case of doubt or if necessary, please consult your healthcare professional.
14. Please use ONLY the DC 4.5V power charger that comes with the package, and handle it with care.

15. It is very important to turn the power of the main unit OFF after each use and before storage to avoid damage to the machine.
16. Please note that changes or modifications not expressly approved by the party responsible for compliance could void the user's authority to operate the equipment.
17. This equipment has been tested and found to comply with the limits for a Class B digital device, pursuant to Part 15 of the FCC Rules. These limits are designed to provide reasonable protection against harmful interference in a residential installation. This equipment generates, uses and can radiate radio frequency energy and, if not installed and used in accordance with the instructions, may cause harmful interference to radio communications. However, there is no guarantee that interference will not occur in a particular installation. If this equipment does cause harmful interference to radio or television reception, which can be determined by turning the equipment off and on, the user is encouraged to try to correct the interference by one or more of the following measures:
  - Reorient or relocate the receiving antenna.
  - Increase the separation between the equipment and receiver.
  - Connect the equipment into an outlet on a circuit different from that to which the receiver is connected.
  - Consult the dealer or an experienced radio/TV technician for help

# Troubleshooting

---

When operational problems occur, please refer to the chart below.  
Do not disassemble the machine or try to repair it by yourself.

Problem	Possible Reason	Possible Solution
Power-On Failure	Power Switch Protection key is not turned on	Push this key to Level "I"
	Lithium battery of the main unit is low	Recharge the main unit at once
	Remote control batteries are low/out	Change batteries
	Remote control batteries are not installed correctly	Check if positive/negative poles of batteries are positioned right Make sure the batteries are snug in place
Weak air pressure or vibration	Lithium battery of the main unit is low	Recharge the main unit at once

# Technical Parameters

---

DC/Power:	DC: 4.5V    Power: 4.5W
Ideal Environment:	Temperature 5°C ~ 40°C    Relative Humidity ≤80%
	Atmospheric Pressure    860hpa ~ 1060hpa
Dimension:	Main Unit: L282mm X W206mm X H254mm
	Controller : L132mm X W44mm X H24mm
Net Weight:	1125g

## Storage

---

- 1.** If left unused, checking the product/turning the power on every 6 months is recommended.
- 2.** Do not store near the floor, wall or roof.
- 3.** Maintain good ventilation and keep away from direct sunlight and corrosive gases.