



WVD100

Wireless Vehicle Detector

EZ Loop

- AP100-PA Relay Board
- S200P Sensor
- S600SM Sensor

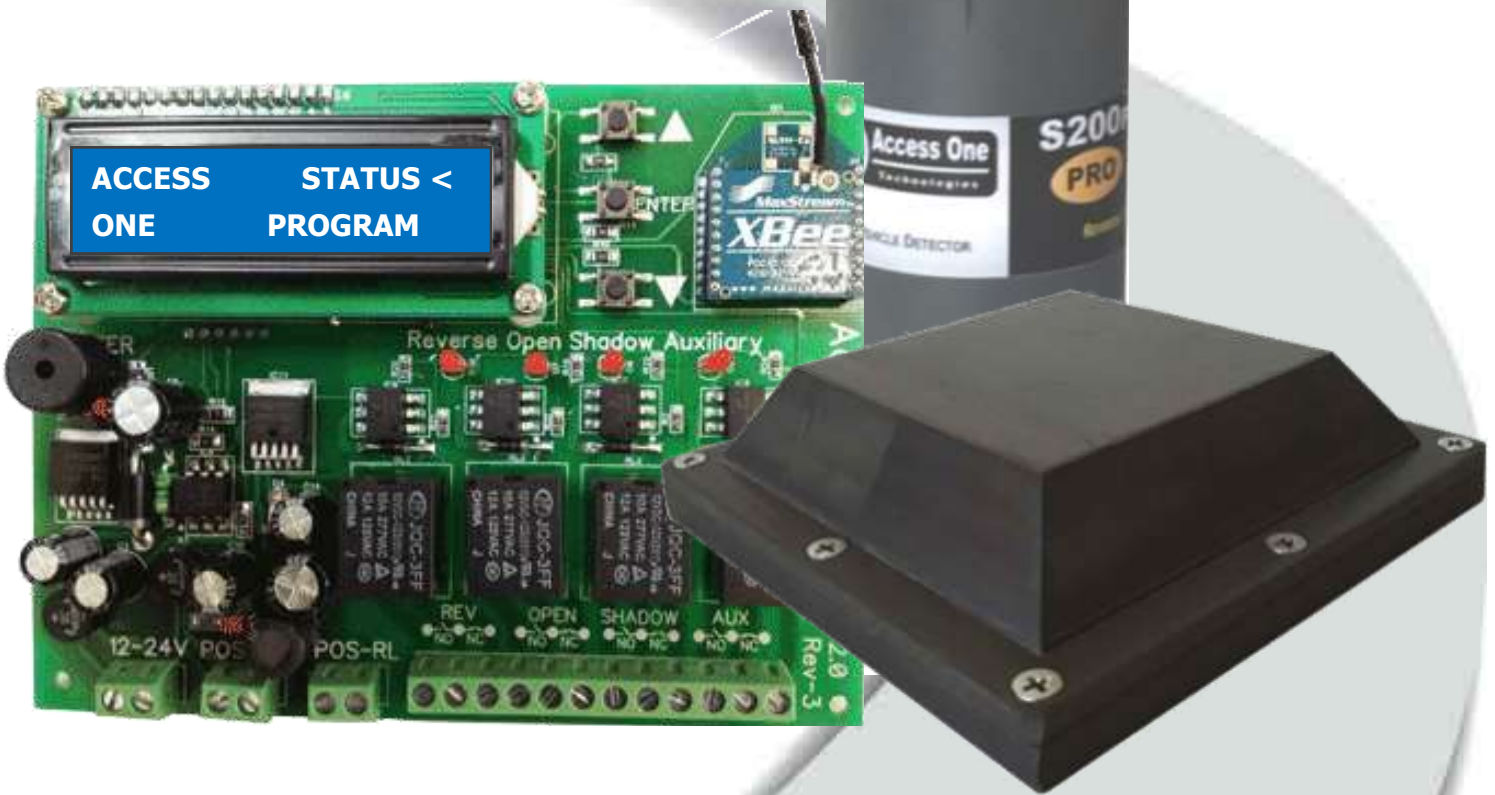

Product Manual

- Installation Instructions
- Program Instructions



Read and follow all U.L. and Safety Standards before installing any access device. Please refer to this manual and qualified personnel for assistance. DO NOT install this device unless all entrapment and pinch points are eliminated.

CONTENTS

Quick Start

Overview	3
1. Install The AP100	3
2. Wiring The AP100	3
3. Learn The Sensor.....	3
4. Program Relays.....	3
5. Activate & Test Sensors	4
6. Select Sensor Location.....	4
7. Drill Sensor Hole	4
8. Install Sensor.....	4
9. Reset Sensor Active	4

Safety Information

Important User Instructions	5
Restrictions & Limitations	5

System Overview

Overview	6
Distance Chart	6

Installation

Mounting The AP100	6
Basic Wiring Overview	6
External Antenna Kit.....	7
Installing The Antenna	7
Antenna Line of Sight	7
Sensor Detection Overview	8
Sensor Location Overview	8
Multi-Lane Applications.....	8
Sensor Slide Gate Layout.....	9
Sensor Swing Gate Layout	9
Sensor Parking Gate Layout.....	10
Prepare The S200P Sensor Hole	10
Install The S200P Sensor In The Driveway	10
Unordinary Installation Suggestions	11
Installing The S200P Sensor In Dirt or Gravel	11
Installing The S200P Sensor On A Hill	11
Installing The S200P Sensor In Snow	12
Above Ground Cap	12
Assemble the S200P Sensor.....	13
S600SM Learn Button	13
Assemble the S600SM Sensor	13
S600SM Sensor Detection	13

Installation (Cont)

Installing The S600SM Sensor With Epoxy	14
Installing The S600SM Sensor With Anchors	14

Sensor Programming

Sensor Learn	15
Relay Programming	15
Sensor Active	16
Sensor Testing	16
Sensor Active Reset.....	16
Sensor Inactive.....	16
Sensor Delete.....	17
Sensitivity Adjustment	17
Sensor Time Schedules	18
Sensor Reset.....	18
Sensor Park Fail	18

AP Programming

Setting The Clock	19
Fail Mode Programming	19
Alarm Programming.....	19
AP100 System Reset	19
Changing The Unit ID	19
Relay Time Schedules.....	20

Operating Instructions

Sensor Detection	20
Sensor Automatic Retune	20
Sensor Park Fault.....	20
Status Menu	20
Relay Status.....	20
Sensor Status	21
Controller Status	21
Faults Status	21
Clock Status.....	21
Default Settings	21
Specifications	21

Troubleshooting

Troubleshooting Chart	22
-----------------------------	----

Limited Warranty

Limited Warranty	23
------------------------	----

QUICK START

Overview:

The EZ Loop is a wireless vehicle detector for vehicle use only. Each system can use one AP100 Access Point Relay Board mounted in the gate operator and up to ten S200 Sensors installed in the driveway.

IMPORTANT: Read the entire manual for complete and proper safety, installation and programming instructions.

1. Install The AP100:

To install the AP100 Relay Board:

1. Mount the AP100 inside the gate operator or in a weather tight housing.
2. Mount the AP100 with a good line of sight to each sensor.
3. Use the plastic standoffs to mount the board. Do not allow the board to rest on the ground or any metal.



2. Wiring The AP100:

The AP100 has four relays for multiple loop functions. Each relay has a NO, C, and NC output. Most gate operators use the NO and C outputs.

1. Connect 12-24 VAC/VDC to the Power Terminal.
2. Connect Relay 1 to the Reverse Loop input.
3. Connect Relay 2 to the Open/Exit Loop input.
4. Connect Relay 3 to the Shadow Loop input.
5. Connect Relay 4 to an auxiliary device.

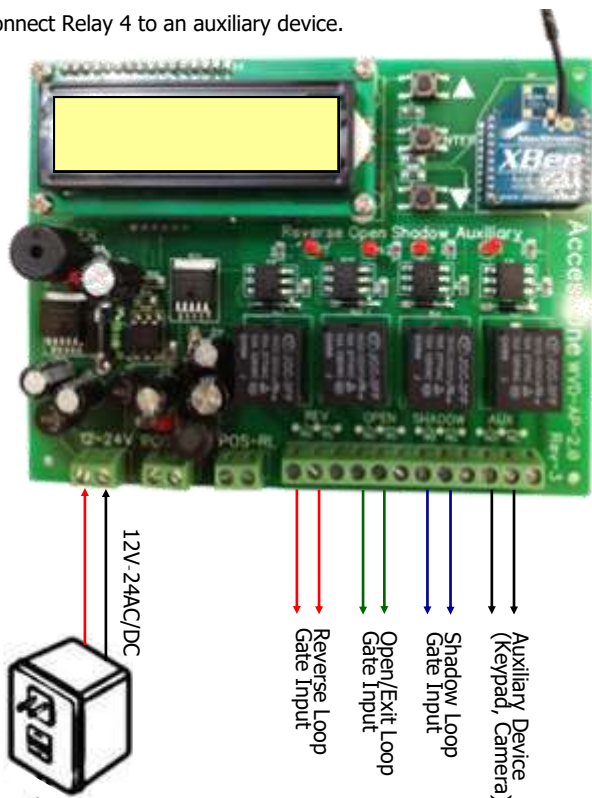

QUICK START

3. Learn The Sensor:

To learn the sensor before installing into the ground:

1. Make sure the AP100 is installed and power is on.
2. Open the Sensor, remove the circuit board, and plug the battery on to the board.
3. Move the Sensor near the AP100
4. Enter the LEARN mode on the AP100 Relay board:
 - a. Select PROGRAM, press Enter
 - b. Select SENSOR, press Enter
 - c. Select LEARN, press Enter
 - d. AP100 will display SEARCHING
 - e. Press the Sensor learn button
 - f. AP100 will see the sensor and display SENSOR# EXISTS message
 - g. Press and hold the Enter button to exit programming
5. Mark the sensor number on each sensor to identify them in setup.
6. Assemble the sensor with the battery, circuit board, antenna ring, and then antenna on top. Make sure the antenna ring is under the antenna with the lip holding the square antenna. Gently fold the antenna wire without kinking it into the housing.

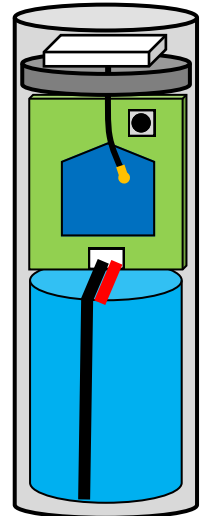
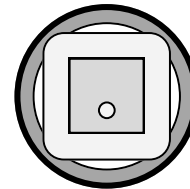
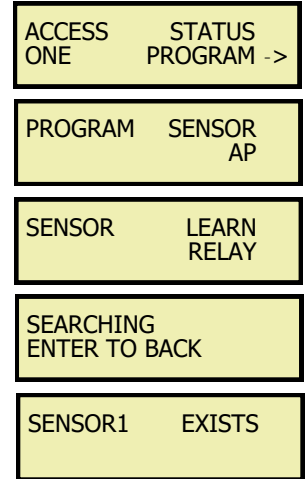

4. Program Relays:

To program the relays to each sensor:

1. Program the relay function on the AP100:
 - a. Select PROGRAM, press Enter
 - b. Select SENSOR, press Enter
 - c. Select RELAY, press Enter
 - d. Select the Sensor to edit, press Enter
 - e. Select Relay for that sensor, press Enter
 - f. Select Relay Function, press Enter (**NORMAL** is the most common setting and will hold the relay while a vehicle is on the sensor, and drop the relay right after the vehicle leaves.)
 - g. Use Up, Down, Enter buttons to enter time of relay action for needed settings, press Enter

Relay 1 = Reverse	Relay 3 = Shadow
Relay 2 = Open	Relay 4 = Auxiliary

QUICK START

5. Activate & Test Sensor:

Activate and test the sensor next to the AP100 and antenna before installing the sensor to insure the sensor is working correctly. To activate the sensor:

1. Place the Sensor on the ground so it is close to the antenna and has a clear line of sight. Do not move the Sensor once it is Active.
2. Program the Sensor Active on the AP100:
 - a. Select PROGRAM, press Enter
 - b. Select SENSOR, press Enter
 - c. Select ACTIVE, press Enter
 - d. Select the Sensor to activate, press Enter
 - e. Select ACTIVE, press Enter
 - f. Hold the Enter button to exit programming
3. Without moving the sensor, test the sensor:
 - a. Place the sensor near the antenna to ensure good communication.
 - b. Do Not Move The Sensor or it will cause a locked on detect.
 - c. Place an object such as a magnetized screwdriver, cell phone or piece of metal right next to the sensor. The Sensor should detect.
 - d. Remove the object. The Sensor should drop detect.

6. Select Sensor Location:

Detection range is similar to a rectangular bubble around the sensor. Average detection distance from the sensor is approximately 8ft wide x 4ft deep x 3-4ft high. In some occasions the distance may be less and in some occasions the distance may more. A simple above ground test can help define the distance.

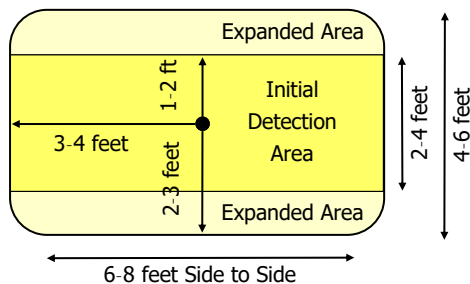

To layout a standard gate application:

1. Place the sensor in the center of the traffic lane.

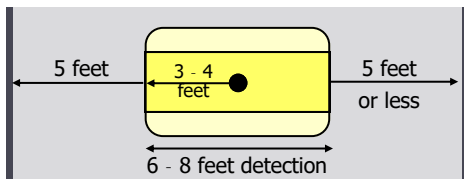

2. Determine if one or multiple sensors will be needed for full detection across a wide traffic lane.
3. When a sensor is placed on the side of the driveway, make sure it reaches far enough into the lane to detect a vehicle.
4. Place the sensor far enough away from the gate so the moving gate does not activate the sensor. Usually **8-10 feet from the gate.**

QUICK START

7. Drill Sensor Hole:

To prepare the Sensor hole for installation:

1. Drill a 2" wide hole 5" deep. (Tip: Use a Dry Diamond Core Bit to core drill the hole)
2. If the hole is more than 5" deep, add sand to make the sensor flush with the top of the driveway.

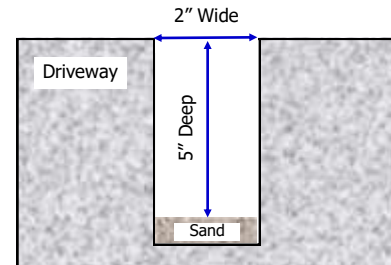

8. Install Sensor:

To install the Sensor in the driveway:

1. Close the Sensor housing tightly making sure the top has sealed against the O-rings.
2. Place the sensor in the hole with **the line on the housing facing toward the gate and traffic lane.**
3. Secure the housing in the driveway with a sealant. The Sensor needs to be secured so that it does not turn when a vehicle drives over it.

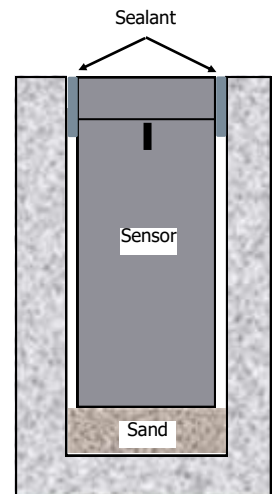

9. Reset Sensor Active:

If a Sensor is Active and then moved, it will detect and lock on detect until it is reset. It will automatically reset after 14 minutes or it can be reset by making it Active again. To reset the Sensor:

1. Program the Sensor Active on the AP100:
 - a. Select PROGRAM, press Enter
 - b. Select SENSOR, press Enter
 - c. Select ACTIVE, press Enter
 - d. Select the Sensor to activate, press Enter
 - e. Select ACTIVE, press Enter
 - f. Wait for the AP100 to go to LEARN
 - g. Hold the Enter button to exit programming
2. Wait up to 2 minutes for the sensor to reset:
 - a. When the Sensor is reset, it will drop detect and the relay should turn off.
3. If the sensor gets moved when sealing it, simply reset it again.

IMPORTANT: Read the entire manual for complete and proper safety, installation and programming instructions.

SAFETY INFORMATION

Important User Information:

Automatic gate systems provide user convenience and limit vehicular traffic. Because these systems can produce high levels of force, it is important that you are aware of the potential hazards associated with the system. Potential hazards may include pinch points, entrapment positions, lack of proper pedestrian access, blind spots for traffic visibility.

It is the joint responsibility of the designer, purchaser, installer and end user to verify the system is properly configured for its intended use. Be sure the installer has instructed you on the proper operation of the gate system before use. Be sure the installer trains you about the basic functions of the required reversing devices associated with the gate system and how to properly test them. Reversing devices may include reverse loops, sensing edges, photoelectric cells, inherent reverse detection, and/or other external devices.

WARNING - To reduce the risk of injury or death:

1. A moving gate can cause serious injury or death. Read and follow all installation manuals, reference manuals, and warning label instructions.
2. Vehicular gates are for vehicles only. Pedestrians must use a separate entrance. Keep all pedestrian traffic away from any vehicular gate. No one should cross the path of a moving gate.
3. Never allow children to operate or play with gate controls. Never allow children to play in the area of a gate system.
4. Access control devices must be placed far enough from moving gates to prevent the user from coming in contact with the gate while operating the controls.
5. All activating devices must be installed in a clear line-of-sight with the gate and its travel and must be installed a minimum of 10 feet away from the gate.
6. Outdoor or easily accessible controls shall have a security feature to prevent unauthorized use.
7. Mount all operating devices clearly out of reach of through gates.
8. Loops and vehicle sensors are for vehicle use only and do not offer any type of pedestrian protection.
9. **DO NOT install this device unless all potential hazards and pinch points have been eliminated.**

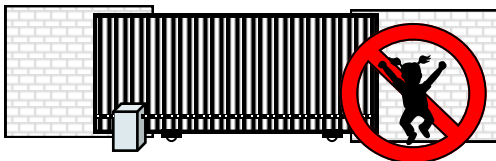

DO NOT allow children to play near, on or with the gate, gate operator, or any of its controls.



DO NOT allow pedestrian use of the vehicular gate. No one should cross the path of a moving gate!

SAFETY INFORMATION

Restrictions and Limitations:

Please read and follow all restrictions and understand all limitations. Do not install this product if it exceeds any limitation or does not abide to all restrictions.

1. This device is intended for vehicular traffic only. Keep all pedestrian traffic including bicycles away from any vehicular gate.
2. Do not use this product for use with motorcycles unless proper safety photo beams and safety edges are installed.
3. This product is a wireless device and subject to occasional communication failures. Therefore proper safety photo beams and safety edges must be used in conjunction to the system.
4. Detection distance and performance will vary based upon location of each application.
5. Average detection area for a sensor is approximately 8ft wide x 4ft deep x 3-4ft high. In some occasions the area may be less and in some occasions the area may be more.
6. Detection area is similar to a rectangular bubble around the sensor.
7. There is a 1-2 second delay between detection and relay activation.
8. Special attention is required for applications with commercial trucks with high trailers due to the limited detection height. Added time delay may be required.
9. This product is not recommended to be used as a down loop for a barrier arm application due to the possibility of a quick loss in detection while a vehicle is present. When used with barrier arms, use the product as a reverse loop and turn the barrier arm operator time delay on.
10. This product is a wireless device and location of the AP100 Relay Board and each Sensor will have a significant effect on the performance. Locate the devices with a full clear line of sight.
11. Large walls, steel fences, foliage, etc will hamper the radio signal range. Try to avoid such hazards.
12. The system should be checked on a regular basis by a trained and authorized installer.

IMPORTANT:

DO NOT PARK IN THE PATH OF THE GATE. This unit will automatically retune and reset after detecting for more than 14 minutes when in reset mode. This allow the gate to close on a vehicle.



SYSTEM OVERVIEW

Overview:

The EZ Loop is a wireless vehicle detector for vehicle use only and eliminates the need for hard wired loops. Each system can use one AP100 Access Point Relay Board mounted in the gate operator and up to ten Sensors installed in the driveway.

AP100-PA Relay Board:

The AP100-PA is the detector board installed in the door or gate operator. It has four relays for Reverse, Open, Shadow, and Auxiliary use. Normally only one AP100 board is required for each entrance.



S200P Sensor:

The S200P is an inground wireless sensor and works similar to a traditional loop. Normally one is placed in each area a traditional loop is placed.



S600AG Sensor:

The S600AG is an above ground wireless sensor and works similar to a traditional loop. Normally one is placed in each area a traditional loop is placed.



External Antenna Kit:

The ANT-KIT-LMR200-6dBi is an external antenna kit for the AP100-PA control board. It allows the antenna to be placed outside the door or gate operator and placed up high on the gate line for a clear line of sight to the sensors. Access One always recommends the use of the External Antenna Kit to help improve the signal for the system.



Above Ground Sensor Cap:

The AGC-06x1.25 is an Above Ground Cap to help improve and extend the radio range distance of a sensor. The Above Ground Cap sits on top of the driveway and pulls the sensor up 1" to allow the antenna to be above the installation hole. The AGC-06x1.25 can be added to any existing S200P sensor at any time.



Distance Chart:

Refer to the below chart for average distances for the sensor placement from the AP100 antenna:

	S200P Sensor	S200P with Above Ground Cap
AP100-PA	8-10 feet	10-15 feet
AP100-PA With Ext Antenna	10-20 feet	15-75 feet

INSTALLATION

Mounting The AP100:

The AP100 Relay Board should be mounted inside the gate operator away from the elements of the weather or in a weather tight housing.



1. Use the plastic standoffs to mount the AP100 board. Do not allow the board to rest on the ground or any metal shelf as it can cause the board to short and fail.
2. Access One always recommends the use of the external antenna and a direct clear line of sight to each sensor. Refer to "Locating The Antenna" for more details.
3. If not using the external antenna, mount the AP100 Relay Board as high as possible. The lower it is to the ground the less the reception will be. Also mount the AP100 as far away from metal in the operator as possible. Metal such as the control box and frame will limit the range.

Basic Wiring Overview:

The AP100 has four relays for multiple loop functions. Each relay has a NO, C, and NC output. Most gate operators use the NO and C outputs. To connect the AP100 for basic use:

1. Connect 12-24VAC/VDC power source to the Power Terminal
2. Connect Relay 1 to the gate operator Reverse Loop input.
3. Connect Relay 2 to the gate operator Open/Exit Loop input.
4. Connect Relay 3 to the gate operator Shadow Loop input.
5. Connect Relay 4 to an auxiliary device. This can be used to arm a keypad or phone entry, turn a camera on, turn a light on, etc.

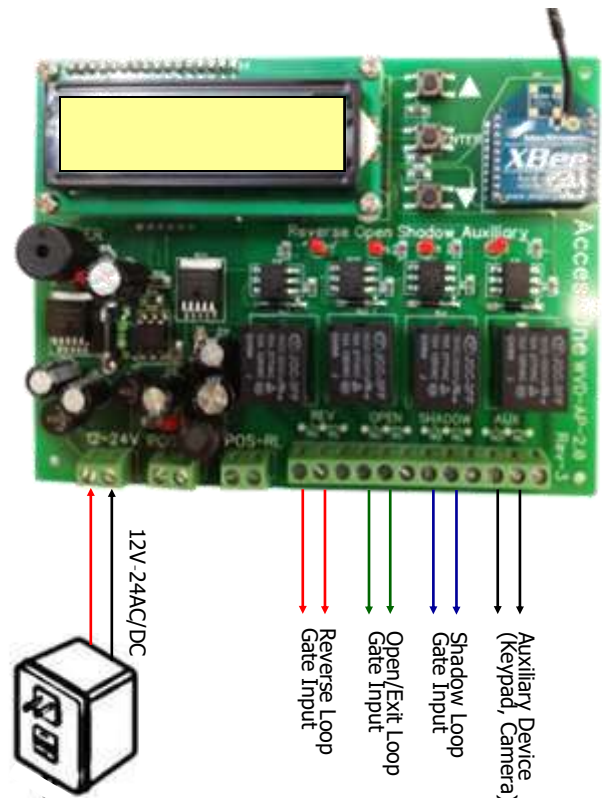

INSTALLATION

External Antenna Kit:

Access One always recommends the use of the external antenna kit to better the signal from the AP100 to each sensor. It is important to understand how the signal strength is greatly reduced when a sensor is installed into a hole several feet away from the gate operator. Therefore every step that can be taken to maximize the signal will greatly help each application. The external antenna kit offers:

- External antenna, L-bracket, N-coupler, and 15 ft coax cable.
- Helps get the antenna out of the operator and up to a clear line of sight
- LMR200 low signal loss cable with a 6dBi N-connector antenna



Installing The Antenna:

The placement of the antenna will have a significant effect on the performance of the system. When locating the antenna, consider the following:

1. Connect the SMA connector (smaller connector) of the coax cable to the blue radio chip on the AP100 board. **Be careful to not pull the antenna chip out of its socket.** The radio chip needs to be pressed all the way in tightly.

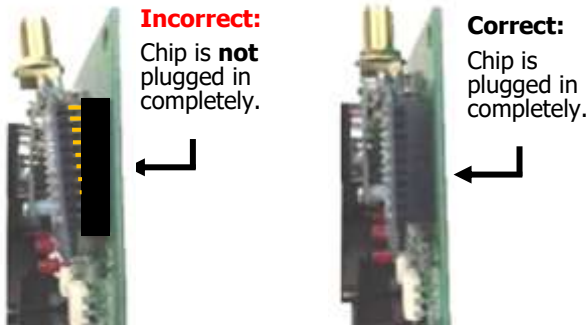

2. Find a location to mount the antenna and L-bracket that allows for a good line of sight to every sensor from the antenna. Note:

- This product is a wireless device and location of the Antenna and each Sensor will have a significant effect on the performance
- Locate the antenna with a clear line of sight to every sensor
- Avoid large walls, steel fences, foliage, etc that will hamper the radio signal
- The higher the antenna is mounted, generally the better the reception.
- When mounting the antenna and bracket, the antenna should be installed in a vertical position (pointing up).



INSTALLATION

Antenna Line of Sight:

Because significant signal strength is lost when a sensor is placed in the hole, it is very important to install the antenna in a location with a full, clear line of sight to every sensor.

1. From ground level (get on your hands and knees) look from the sensor to the antenna to make sure you can see the entire antenna without anything blocking it.
2. If there is not a full clear line of sight, relocate the antenna to a new position with a full clear line of sight.
3. Make sure there is a full clear line of sight when the gate is both open and closed.

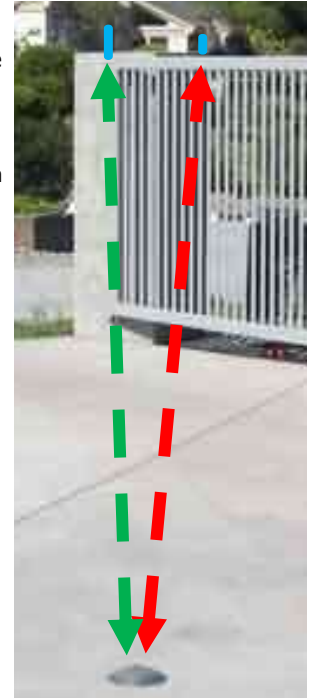

Incorrect:
Line of sight is through the gate.

Correct:
Line of sight is clear of the gate.

4. If a clear line of sight to every sensor is not possible with one antenna, use the antenna T-connector to install a second antenna kit. For example, if there is a large column or wall, one antenna can be installed on the inside of the column or wall, and one antenna can be installed on the outside of the column or wall.
5. Although not common, some applications may need to have one antenna located up high and one antenna located low to get a signal underneath a vehicle. This may occur if the sensors are located close to each other and a vehicle drives past a sensor enough to drop detect but not far enough to allow a clear line of sight to the antenna. In this rare application, the stop detect signal is blocked by the vehicle and will cause the gate to stay open until an updated signal is sent.
6. Each AP100 board includes a small 3dBi antenna. This antenna is usually not strong enough for most applications and the use of the external antenna kit is required. However, if two external antennas are not being used, it is ok to leave the small antenna connected along with the external antenna cable for added coverage.

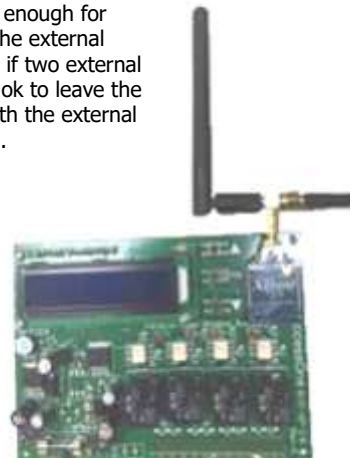

INSTALLATION

Sensor Detection Overview:

The sensor is monitoring the magnetic axis of the earth and looking for a change in the magnetic value. When a large metal mass such as vehicle enters the detection range, the magnetic values are changed and the sensor sends a signal to the AP100 Relay board. The value change is dependent upon the metal mass. For example, a small hammer a few feet above the sensor may not trigger the detection. But a large vehicle with a lot of metal will trigger the sensor. The larger the metal mass, the better the detection. Therefore bicycles, motorcycles and other small metal vehicles may need to be very close to a sensor for detection or may not be detected.

There is a 1-2 second delay from the sensor detecting and the relay activating. This is normal to help prevent false activations from the earth's magnetic spikes. The sensor must see a full second detection before sending the detect signal and the sensor must be cleared for a full second before sending the off signal.

Sensor detection distance and performance will vary based upon location of each application. Detection range is similar to a rectangular bubble around the sensor. Average detection distance from the sensor is approximately 8ft wide x 4ft deep x 3-4ft high. In some occasions the distance may be less and in some occasions the distance may be more. A simple above ground test can help define the distance.

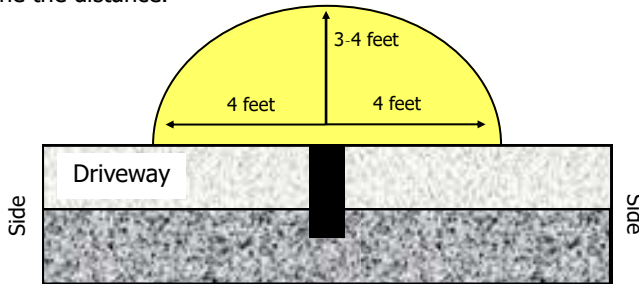

The front and back detection is reduced when the sensor is inactive and increased when in detection mode. For example, a vehicle approaching the sensor straight on will not be detected until 1-2 feet from the sensor. But when the sensor detects the vehicle, it expands the depth to 1-2 feet from the sensor, or 2-4 feet total depth. This feature is used to reduce false triggers and help to not pick up a slide gate after the vehicle has cleared. Side detection is not reduced and is at full detection distance all the time. To detect a vehicle sooner, rotate the sensor 90 degrees.

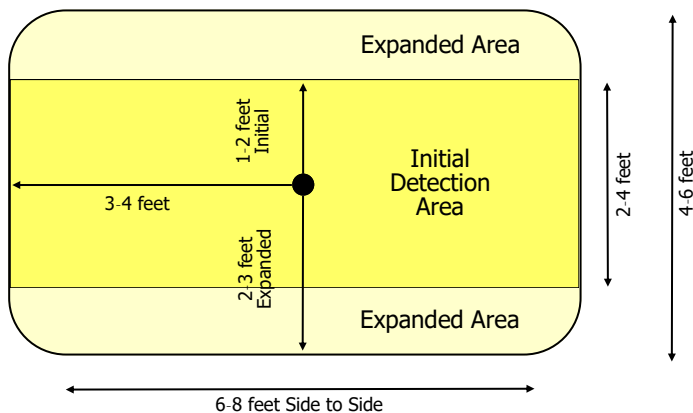

INSTALLATION

Sensor Location Overview:

For best results, sensors should be placed in the center of the driveway or traffic lane.

1. Place the sensor in the center of the traffic lane and determine if one or multiple sensors will be needed for full detection. There should be less than 5ft from the edge of the detection and the side of the traffic lane. This is usually a 16ft - 18ft wide lane.

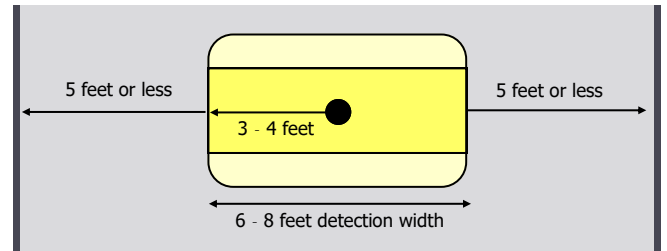

2. In the case of a wide lane, two or more sensors may be needed to cover the width. (Example: For a 25ft driveway and an 8ft detection width, two sensors are recommended.)

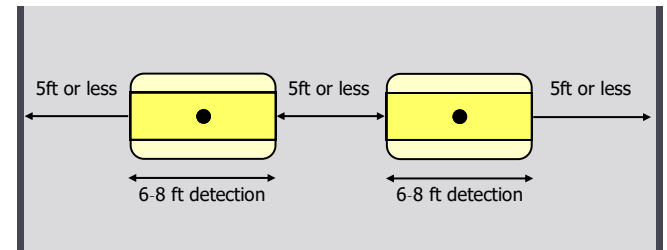

3. If the sensor is going to be placed on the side of the driveway, make sure it reaches far enough into the lane to detect the vehicles. Two sensors, one on each side, may be needed for adequate detection.

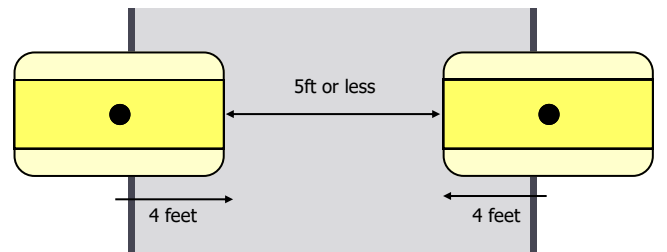

4. Place the sensor far enough away from the gate so the moving gate does not activate the sensor. This is usually 6-8 feet from the gate.
5. Refer to the Sensor Slide Gate Layout and Sensor Swing Gate Layout for more guidelines.

Multi-Lane Applications

For multi-lane applications when two or more AP100s and multiple sensors are close enough to each other, different system IDs should be used for each system to prevent cross talk between the two separate systems. For example, Lane 1 would use ID 0001 and Lane 2 would use ID 0002. These IDs are field settable. Refer to the "Change ID" programming on Page 19.

INSTALLATION

Sensor Slide Gate Layout:

The following diagram shows a typical slide gate application for two-way traffic with a free exit. For one-way traffic, the exit sensor is not needed. (This diagram is a basic layout and does not show safety devices, pedestrian gate, fencing, etc. Refer to the gate operator manual for proper details).

Most slide gate applications will use a Reverse Sensor on the outside and inside of the gate, and an Exit/Open Sensor further down the driveway.

Reverse Sensors are used to keep the gate from timing out. When a vehicle is over a Reverse Sensor, the gate operator should remain open until the Reverse Sensor is cleared and then the gate operator should time out and close. A Reverse Sensor is used on the outside and inside of the gate so that a vehicle in the path of the gate should be within the detection range of either the outside or inside Reverse Sensor. Only installing one Reverse Sensor will not offer proper detection coverage.

An Exit/Open Sensor can be used inside the gate and further down the driveway as a convenient way to automatically open the gate when a vehicle is leaving the property. An Exit/Open Sensor can be up to 20-25ft away using the S200P Sensor or up to 75ft using the Above Ground Cap.

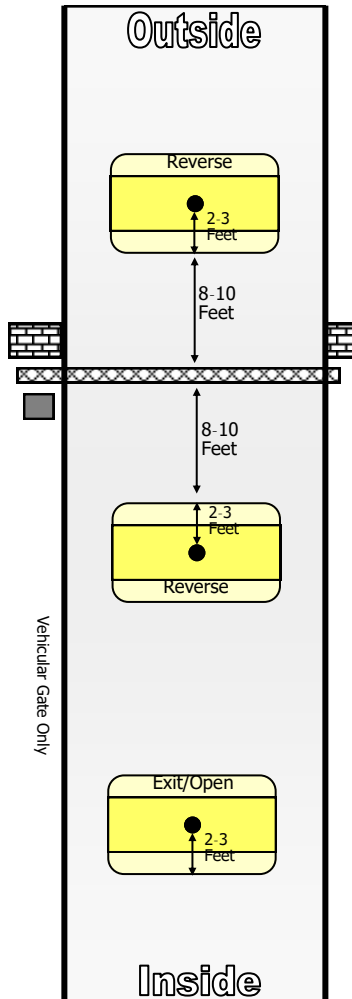

To layout a standard slide gate application:

1. Place the sensor in the center of the traffic lane.
2. Determine if one or multiple sensors will be needed for full detection across a wide traffic lane.
3. Place the sensor far enough away from the gate so the moving gate does not activate the sensor. This is usually 8-10 feet from the gate.
4. Mark the location of where each sensor will be installed.

INSTALLATION

Sensor Swing Gate Layout:

The following diagram shows a typical swing gate application for two-way traffic with a free exit. For one-way traffic, the exit sensor is not needed. (This diagram is a basic layout and does not show safety devices, pedestrian gate, fencing, etc. Refer to the gate operator manual for proper details).

Most swing gate applications will use a Reverse Sensor on the outside and inside of the gate, and an Exit/Open Sensor down the driveway. Some applications will use a Shadow Sensor to cover the swing area of the gate.

Reverse Sensors are used to keep the gate from timing out. When a vehicle is over a Reverse Sensor, the gate operator should remain open until the Reverse Sensor is cleared, then the gate operator should time out and close. A Reverse Sensor is used on the outside and inside of the gate so that a vehicle in the path of the gate should be within the detection range of either the outside or inside Reverse Sensor. Only installing one Reverse Sensor will not offer proper detection coverage and the addition of a Shadow Sensor may be needed.

A Shadow Sensor is used to cover the swing area of the gate when the Reverse Sensors are too far apart to cover a vehicle in between. **Test the Shadow Sensor prior to installing to make sure it does not pickup the gate.**

An Exit/Open Sensor can be used inside the gate and further down the driveway as a convenient way to automatically open the gate when a vehicle is leaving the property. An Exit/Open Sensor can be up to 20-25ft away using the S200P Sensor or up to 75ft using the Above Ground Cap.

To layout a standard swing gate application:

1. Place the sensor in the center of the traffic lane.
2. Determine if one or multiple sensors will be needed for full detection across a wide traffic lane.
3. Place the sensor far enough away from the gate so the moving gate does not activate the sensor. This is usually 8-10 feet from the gate. Note: The Reverse Sensor near the swing of the gate should be 8-10 feet from the swing path of the gate.
4. Mark the location of where each sensor will be installed.

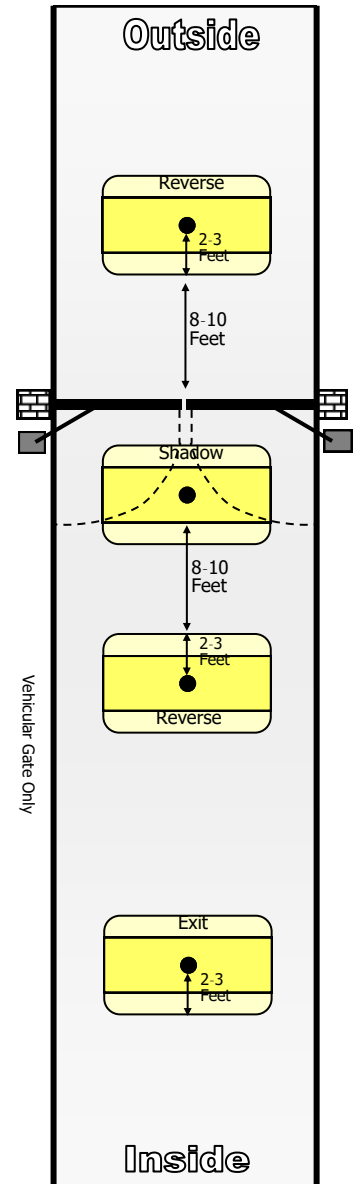

INSTALLATION

Sensor Parking Gate Layout:

The following diagram shows a parking gate application for two-way traffic with a free exit. For one-way traffic, the exit sensor is not needed. (This diagram is a basic layout and does not show safety devices, pedestrian gate, fencing, etc. Refer to the gate operator manual for proper details).

Most parking gate applications will use a Reverse Sensor under the arm of the gate, and an Exit/Open Sensor further down the driveway.

DO NOT USE AS A DOWN LOOP. Because wireless devices cannot guarantee a continued connection, Parking gate operators using the wireless sensor should be set with the time delay on and the Reverse Sensor to reverse and hold the gate arm when a vehicle is present. The time delay is recommended in the rare case that the sensor signal is briefly lost or missed.

Reverse Sensors are used to keep the parking arm from timing out. When a vehicle is over a Reverse Sensor, the parking arm should remain up until the Reverse Sensor is cleared and then the operator should time out and close. A Reverse Sensor is used under the arm of the gate so that a vehicle in the path of the arm should be within the detection range while both outside and inside the arm. Rotate the Reverse Sensor 90 degrees to help cover the arm area more. If one Reverse Sensor does not cover both the outside and inside area, then install a second Reverse Sensor for proper detection coverage.

An Exit/Open Sensor can be used inside the gate and further down the driveway as a convenient way to automatically open the gate when a vehicle is leaving the property. An Exit/Open Sensor can be up to 20-25ft away using the S200P Sensor or up to 75ft using the Above Ground Cap.

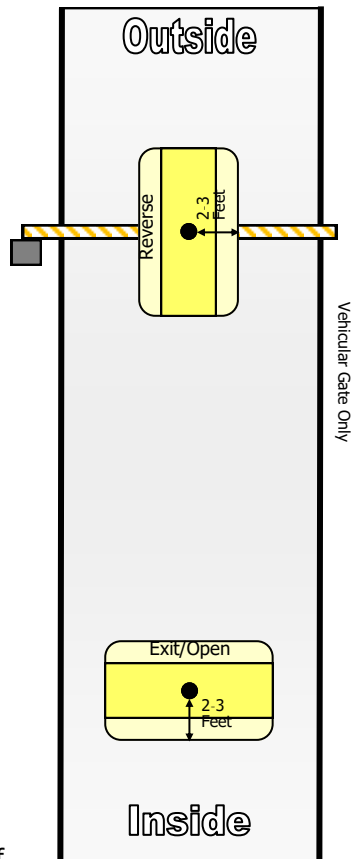

To layout a standard slide gate application:

1. Place the sensor in the center of the traffic lane.
2. Determine if one or multiple sensors will be needed for full detection across a wide traffic lane.
3. Determine if one or multiple sensors will be needed to cover the detection area outside and inside the parking arm.
3. Mark the location of where each sensor will be installed.

INSTALLATION

Preparing The S200P Sensor Hole:

To prepare the S200P Sensor hole for installation:

1. Access One always recommends testing the sensor above ground in its desired location before drilling the hole to make sure the sensor does not pick up the gate.
2. Drill a 2" wide hole 5" deep. (Tip: Use a Dry Diamond Core Bit for concrete or asphalt to core drill the hole)
3. If the hole is more than 5" deep, add sand to **make the sensor flush with the top of the driveway.**

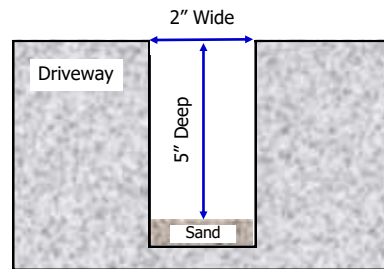

Install The S200P Sensor In The Driveway:

To install the Sensor in the driveway:

1. Close the Sensor housing tightly making sure the top has sealed against the O-rings.
2. If the hole is more than 5" deep, add sand to **make the sensor flush with the top of the driveway.**
3. Place the sensor in the hole with the line on the housing facing toward the gate and toward the traffic.
4. Secure the housing in the driveway with a sealant. Seal between the sensor edge and the driveway edge - much like caulking a window.
5. Do not use a runny sealant or place sealant deep in the hole as it will make it very difficult to remove the housing at a later time.
6. The Sensor needs to be secured enough that it does not turn when a vehicle drives over it.

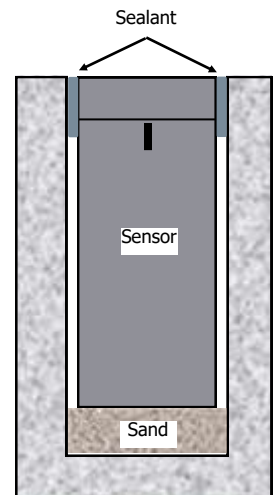

S200P Sensor Housing Alignment:

Use the line on the sensor housing to properly align the sensor when placing it in the hole.

1. Point the housing notch toward the gate and lane of traffic - not toward the antenna.
2. The sensor's detection area is approximately 8 ft wide x 3-4 ft deep.
3. Pointing the notch toward the gate will keep the detection area of the sensor wide.
4. Pointing the notch toward the side of the driveway will make the detection area deep and possible pick up the gate.

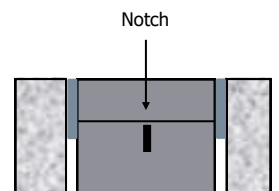

INSTALLATION

Unordinary Installation Suggestions

1. If the driveway is less than 5 inches thick, drill the 2" wide hole 5" deep into the road base. Use sand to level it and the sealant to secure the sensor.
2. If installing a sensor on the side of the driveway, we recommend using a small irrigation box installed and filled with sand or gravel. This will make it much easier to locate the sensor for future service.

Installing The S200P Sensor In Dirt or Gravel

If installing a sensor into a gravel or DG driveway, it is suggested to dig out an area and pour a small pad of concrete for an anchor to hold the sensor. When installing the sensor:

1. Dig a hole approximately 1 ft deep x 1 ft wide.

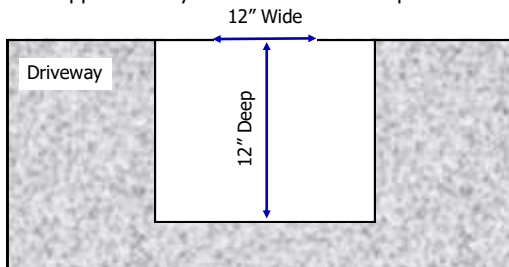

2. Pour 3-4 inches of concrete in the bottom of the hole to act as an anchor.
3. Use a 2" PVC sleeve and place it upright into the concrete.

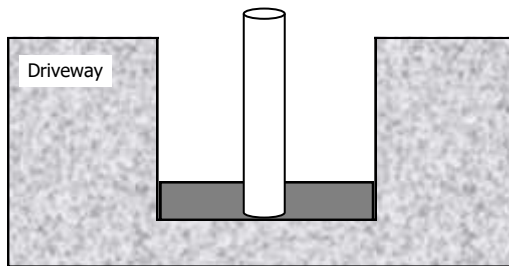

4. Stabilize the PVC and let the concrete cure.
5. Fill the hole back in with the dirt or gravel up to normal level.
6. Cut any remaining PVC down to the road surface.
7. Fill the PVC sleeve with sand to bring the sensor flush with the top and road surface.
8. Install the sensor into the PVC sleeve the same as it would be installed in the driveway.

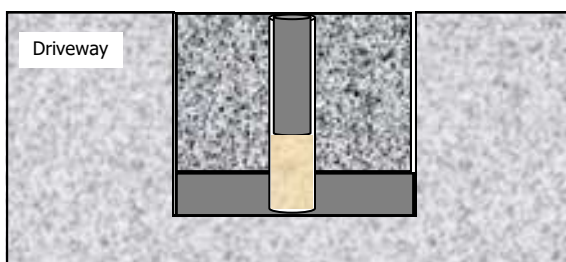

INSTALLATION

Installing The S200P Sensor On A Hill

Hill applications can be difficult for installation as the hill can create signal loss and require some adjustments to the sensor installation. Because of the signal issues that can occur on hill applications, it is strongly suggested to use the Above Ground Cap. Issues to consider on hill applications:

Downhill Applications:

1. Downhill applications can cause a loss of signal strength because the lip of the hole may block the line of sight from the sensor to the antenna.

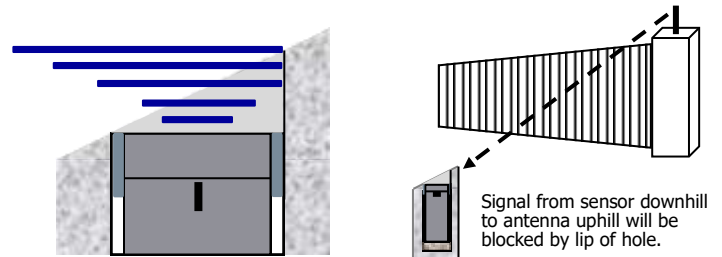

2. Installing the sensor parallel with the driveway will help eliminate the lip but will change the orientation of the antenna pattern of the sensor to more of an angle and may not reach as far.

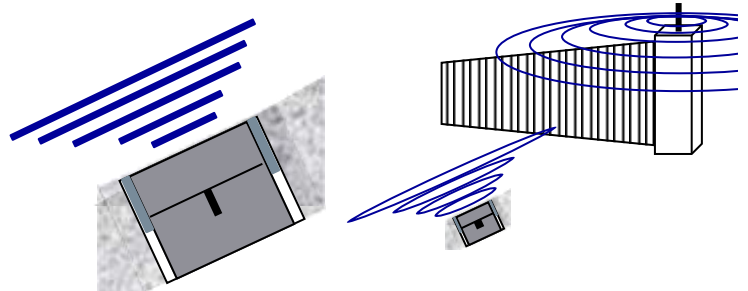

3. Although the AP100 antenna will be naturally high in a downhill application, be careful that an open or closed gate does not block the line of sight. The angles become much more and line of sight can be blocked more easily.
4. Although the AP100 antenna will be naturally high in a downhill application, consider the antenna placement with the opposite sensors that may be uphill. For example, the inside sensor may be downhill, but the outside sensor may be uphill requiring the antenna to be placed higher than normal.
5. In some rare applications, it may be necessary to add a second antenna down the driveway to help with the signal and application.

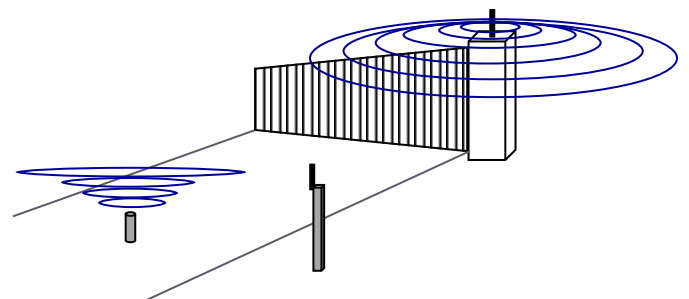

INSTALLATION

Installing The S200P Sensor On A Hill (Cont)

Uphill Applications:

1. Uphill applications can cause a loss of signal strength because the sensor may end up higher than the antenna. This would be similar to a normal application with the antenna mounted low to the ground. It may be necessary to raise the antenna higher than normal to have a good range to the uphill sensor.

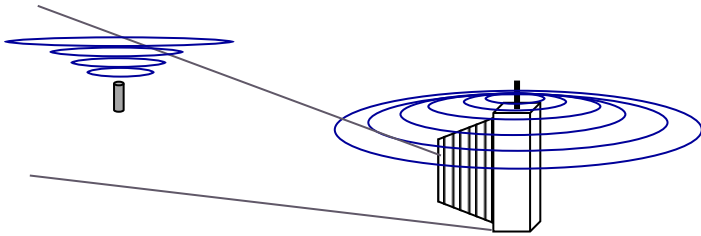

2. Installing the sensor parallel with the driveway will help eliminate the lip but will change the orientation of the antenna pattern of the sensor to more of an angle and may not reach as far.
3. Because the AP100 antenna will be naturally lower in an uphill application, be careful that an open or closed gate does not block the line of sight. The angles become much more and line of sight can be blocked more easily.
4. Consider the antenna placement with the opposite sensors that may be downhill. For example, the inside sensor may be uphill, but the outside sensor may be downhill requiring the antenna to be placed to have a clear line of sight to all sensors.
5. In some rare applications, it may be necessary to add a second antenna down the driveway to help with the signal and application.

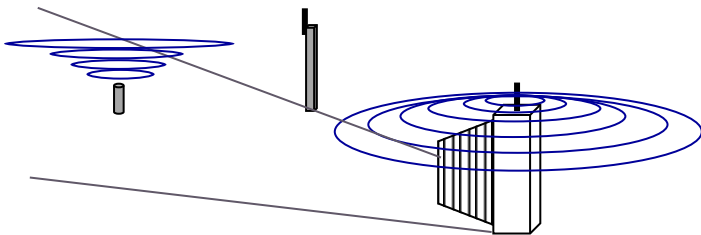

Installing The S200P Sensor In Snow

Sensors may be installed in snow locations but the following precautions should be taken:

1. Install the sensor flush with the road surface so shovels and snow plows will not damage the sensor.
2. If better signal strength is needed and use of an Above Ground Cap on top of the driveway is not possible, mount the sensor with at cutaway around it. The cutaway should be wide enough for the above ground cap to be recessed deep enough that a snow plow will not hit it. Make sure to seal the cap so it does not move. Screws or anchors are recommended for this application so future access for service is more simple.

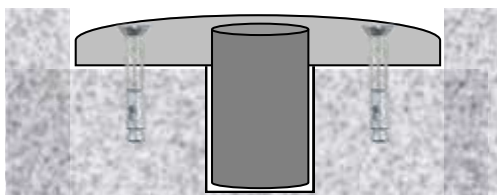

INSTALLATION

Above Ground Cap

The Above Ground Cap is used to help raise the S200P Sensor antenna above the ground for better signal strength. It is important to secure the cap and sensor in place when installation is complete. To install the cap and sensor:

1. Remove the standard cap from the sensor.
2. Screw the Above Ground Cap securely onto the sensor making sure the top has sealed against the O-rings.
3. Place the sensor in the hole with the alignment line on the housing facing toward the lane of traffic.

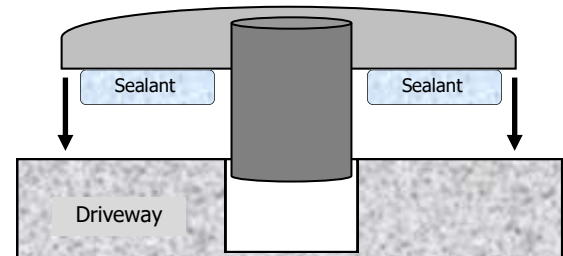

4. Spread silicone or sealant on flat side of cap and press onto driveway.
5. Secure the housing and cap with a sealant or red heads so the sensor and cap will not turn or move when a vehicle drives over it. The cap must be secure enough to prevent any stress or torque on the inground housing. Failure to properly secure the cap will result in damage to the inground housing.

Installation Tip:

It may be easier to drill a few holes in the cap and secure it to the driveway using red head screws. This will make it easier to remove for service.



IMPORTANT! The Above Ground Cap must be secured and not allowed to move. If not properly secured, it may damage the sensor housing allowing moisture to enter the system and damage the electronics. Water damage to the sensor is not covered under warranty.

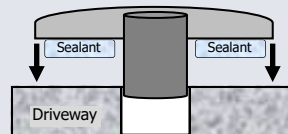

1. Spread silicone or sealant on flat side of cap and press onto driveway.
2. Cap must be secure enough to prevent any stress or torque on the inground housing.



1. Drill a holes in the cap and secure it to the driveway using red head screws.
2. Cap must be secure enough to prevent any stress or torque on the inground housing.

INSTALLATION

Assemble the S200P Sensor

The sensor consists of a battery, PCB, antenna ring, and antenna. To assemble the S200P:

1. Place the battery at the bottom of the housing with the wire leads at the top of the battery.
2. Using the long grooves, slide the circuit board into the housing. The battery connector should be at the bottom and the learn button at the top.
3. Slide the antenna ring over the antenna. The lip on the ring should be on the bottom so the antenna rests on it.
4. Gently fold the antenna wire and place the antenna in the antenna ring on top. The antenna should be resting on the lip of the antenna ring.
5. Make sure to not bend or kink the antenna wire as a hard bend can break the solid coax wire.
6. Screw the cap securely onto the sensor making sure the top has sealed against the O-rings.

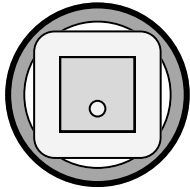
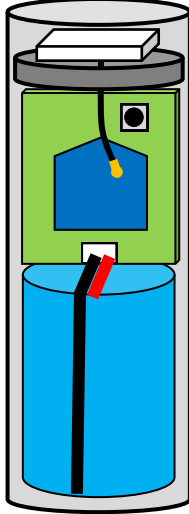

S600SM Sensor Learn Button:

To access the sensor learn button for programming:

1. Remove the eight screws holding the top of the housing to the housing base.
2. Remove the mounting strap and screw.

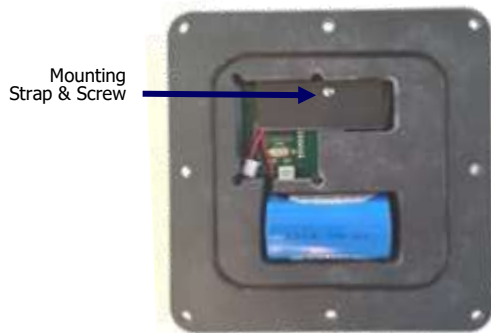

3. Pull the Sensor board up and the learn button is on the front side.



IMPORTANT:

The Sensor board and antenna are installed face down allowing them to point upward when the base plate is installed and the sensor is turned upright.

INSTALLATION

Assemble The S600SM Sensor:

The S600SM includes a battery, Sensor board, antenna, and mounting strap. To assemble the sensor:

1. Turn the top cover upside down.
2. Place the battery in the battery compartment with the battery wires going through the slot to reach the Sensor board.
3. Place the antenna face down in the antenna compartment with the antenna wire going through the slot to the Sensor board. (Green back of the antenna should be seen).
4. Place the Sensor board face down in the compartment with the battery wires and antenna wires going through each slot. (Back of Sensor board should be seen).

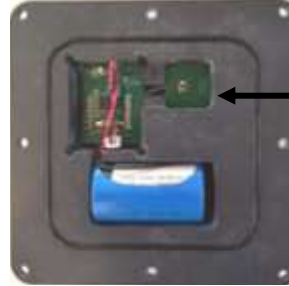

5. Place the foam spacer on top of the antenna and install the mounting strap over the Sensor board, antenna/foam and battery wire with the 4-40 screw.
6. Place the base plate on top of the housing cover and check to **make sure everything fits and nothing will stop the baseplate and cover from sealing.** Only the O-ring should cause separation and seal cleanly when the parts are connected.
7. Turn the baseplate and cover upright and install the 8 screws to seal the housing. **IMPORTANT: The baseplate and cover must seal together tight to prevent any water from entering the housing.** Use Loctite on each screw to prevent them from backing out over time.

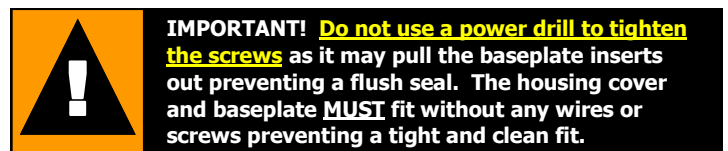
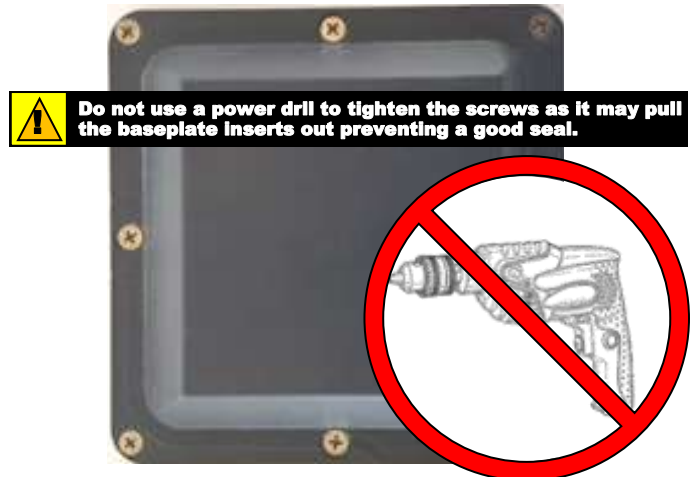

INSTALLATION

S600SM Sensor Direction:

The detection area is rectangular and is approx. 8ft wide x 4ft deep. To properly orientate the sensor, direction arrows are located on the baseplate and sensor cover.

1. Locate the direction arrows on the sensor cover.
2. Point the direction arrows toward the gate parallel with the line of traffic.

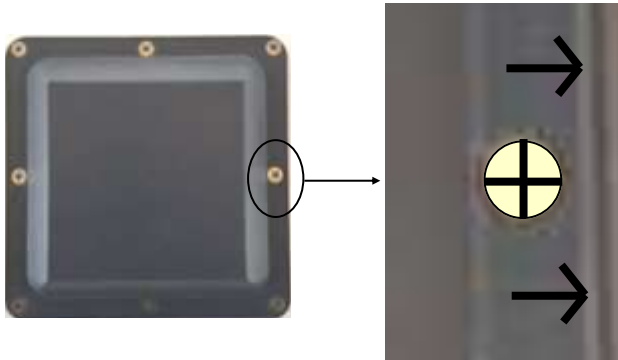

Installing The S600SM Sensor With Epoxy:

The sensor can be secured to the driveway with screw anchors or a standard concrete epoxy. To mount the sensor using epoxy:

1. Select the sensor location and test the sensor before securing it. Make sure it tests properly and drops detect in the full open or full closed position.
2. Using an epoxy such as Loctite or JB Weld, spread the epoxy on the bottom of the baseplate and press to the driveway.

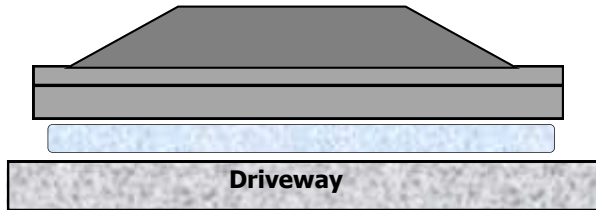

In rare instances such as extreme traffic or vandalism prone applications, a stronger epoxy might be needed. In such applications a cement epoxy similar to what is used to hold down highway reflectors can be used. One source we recommend is:

https://stop-painting.com/order_form.asp
Stop-Painting.com

AP-43 Epoxy Kit for Road Reflectors—One Quart

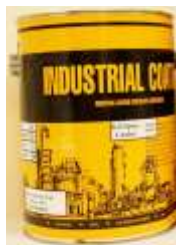

INSTALLATION

Installing The Sensor With Anchors:

The sensor can be secured to the driveway with four 1/4" Flat Head Sleeve Anchors. To mount the sensor using anchors:

1. Select the sensor location and test the sensor before securing it. Make sure it tests properly and drops detect in the full open or full closed position.
2. Open the sensor and locate the four anchor mounting holes on the baseplate.



3. Drill out the holes on the baseplate so the anchor screw can pass through. Then mark the location of each hole.
4. Drill and clean the anchor holes. (A 5/16" drill bit is commonly used.)
5. Drive the anchor through the baseplate and into the anchor hole and tighten the anchor screw until the baseplate is secure.
6. **IMPORTANT: The anchor screws must be tightened all the way down and cannot stick up above the top of the baseplate.** If it is not, it will not allow the unit to seal properly.

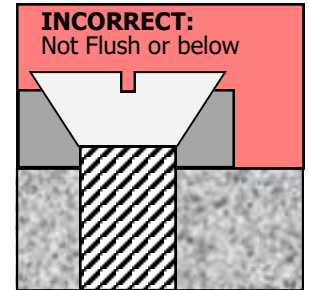
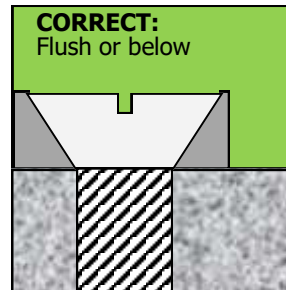

SENSOR PROGRAMMING

Sensor Learn

To learn the sensor before installing into the ground:

1. Make sure the AP100 is installed and power is on.
2. Open the Sensor, remove the circuit board, and plug the battery on to the board.



3. Move the Sensor near the AP100
4. Enter the LEARN mode on the AP100 Relay board:
 - a. Use the Up, Down, Enter buttons to the right of the LCD

b. Select PROGRAM, press Enter

ACCESS ONE	STATUS PROGRAM ->
------------	-------------------

c. Select SENSOR, press Enter

d. Select LEARN, press Enter

PROGRAM	SENSOR AP
---------	-----------

e. AP100 will display SEARCHING

f. Press the Sensor learn button

SENSOR	LEARN RELAY
--------	-------------

g. AP100 will see the sensor and display the SENSOR# EXISTS

SEARCHING	ENTER TO BACK
-----------	---------------

h. Repeat for each Sensor

i. Press and hold the Enter button to exit programming.

SENSOR1	EXISTS
---------	--------

5. Mark the Sensor number on each sensor to identify them in setup

6. Assemble the sensor with the battery, circuit board, antenna ring, and then antenna on top. Make sure the antenna ring is under the antenna with the lip holding the square antenna. Gently fold the antenna wire without kinking it into the housing.

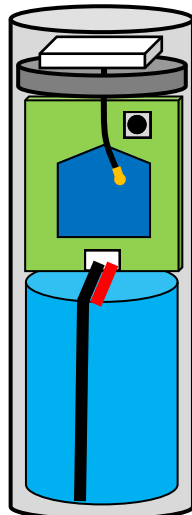
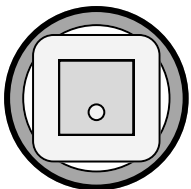

IMPORTANT:

Do not learn a sensor and not make it active or it will drain the battery very quickly. When a sensor is in learn mode, it is on in full power waiting for the AP100 to make it active. If a sensor is learned but not made active, unplug the sensor battery until it is time to make the sensor active.

SENSOR PROGRAMMING

Relay Programming

There are four relays on the AP100. Each relay is pre-labeled for Reverse, Open, Shadow, and Auxiliary outputs but they can be used for whatever function is desired. Each Sensor can be set to activate a single relay or multiple relays and different relay functions can be set for each Sensor. For example Sensor1 may be programmed to activate Relay1 as a momentary contact for 1 second, while Sensor2 may be programmed to activate Relay2 as momentary contact and Relay4 as a toggle contact. The relay actions available are: None, Normal (momentary), Latch, Latch Timeout, Unlatch, Toggle. To set the relay function for a Sensor:

1. Select PROGRAM, press Enter

ACCESS ONE	STATUS PROGRAM ->
------------	-------------------

2. Select SENSOR, press Enter

PROGRAM	SENSOR -> AP
---------	--------------

3. Select RELAY, press Enter

4. Select SENSORx for the sensor to edit, press Enter
X = Sensor to be programmed

SENSOR	RELAY -> ACTIVE
--------	-----------------

5. Select RELAYx, for the relay that sensor will activate, press Enter.
X = Relay to be programmed

SENSOR	SENSOR1 -> SENSOR2
--------	--------------------

6. Select Relay mode, press Enter
Each relay default is NONE.
NORMAL is the most common

SENSOR	RELAY1 -> RELAY2
--------	------------------

7. For Momentary or Latch Timeout, enter the time in HH:MM:SS. The default of 000000 is most common.

RELAY1	NONE NORMAL
--------	-------------

8. Press and hold the enter button to exit programming.

RELAY1 TIME	000000
-------------	--------

Relay	Function	Default
Relay 1	Reverse	None
Relay 2	Open/Exit	None
Relay 3	Shadow/Center	None
Relay 4	Auxiliary	None

Function	Description
None	Default = No relay action (turned off)
Normal	Activates upon detect, drops at detect off
Latch	Activates upon detect, needs unlatch to drop
Latch Timeout	Activates upon detect for hh:mm:ss time
Unlatch	Drops activation upon detect
Toggle	Activates on 1st detect, deactivates on 2nd detect

SENSOR PROGRAMMING

Sensor Active

Once a Sensor has been learned, it needs to be programmed Active. Programming the Sensor active will start the detection mode and allow the sensor to report back to the AP100. **NOTE: Once a Sensor has been Activated, any movement will cause it to detect.** If the sensor is moved and locks on detect, it will maintain detect for 14 minutes until it resets/retunes itself or can be reset by making it Active again. To program a Sensor Active:

1. Select PROGRAM, press Enter
2. Select SENSOR, press Enter
3. Select ACTIVE, press Enter
4. Select SENSORx, press Enter (x = Sensor being programmed)
5. Select ACTIVE, press Enter
6. ACTIVE SET OK message should display
7. Press and hold the Enter button to exit programming.

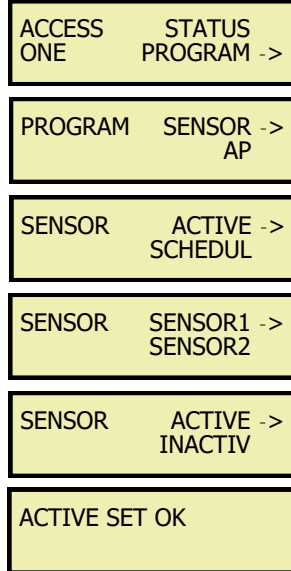

Sensor Testing

It is strongly recommended that each sensor be tested for proper communication and relay action before installing the sensor. To test a sensor:

1. Place the sensor near the AP100 antenna to insure good communication.
2. Do not move the sensor or it will lock on detect.
3. Place a magnetized screw driver, cell phone, or piece of metal right next to the sensor. The sensor should detect.
4. Remove the object, the sensor should drop detect.

Note: There is a 1-2 second delay from the sensor detecting and the relay activating. This is normal to help prevent false activations from the earth's magnetic spikes.

Note: Once the sensor has been tested, if it is moved, it will lock on detect. The sensor will reset/retune after 14 minutes or can be programmed active again to force a reset. See "Sensor Active Reset" on Page 14 for details.

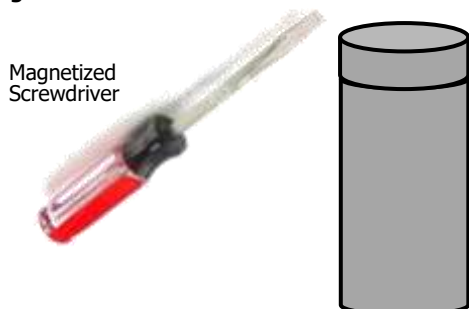

SENSOR PROGRAMMING

Sensor Active Reset

If a sensor is Active and then moved, it will detect and lock on detect until it is reset. For example, if a sensor is programmed Active for testing, then moved to install in its hole, the sensor will detect and lock on detect until it is reset. A sensor will reset automatically after 14 minutes. At that time the sensor will retune itself to its new position and reset to drop detection. A sensor can be forced to reset/retune without having to wait 14 minutes by giving it a new Active command. To manually reset the sensor:

1. Select PROGRAM, press Enter
2. Select SENSOR, press Enter
3. Select ACTIVE, press Enter
4. Select SENSORx, press Enter (x = Sensor being programmed)
5. Select ACTIVE, press Enter
6. Wait for the screen to go back to LEARN. Note: The AP100 does not show ACTIVE SET OK because the sensor has already been made Active.
7. Press and hold the Enter button to exit programming.

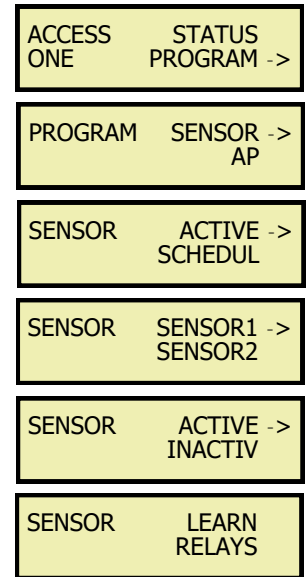

8. Wait up to 2 minutes for the sensor to reset. The sensor reports to the AP100 every 2 minutes. The next time the sensor reports to the AP100, it will be told to reset. If the sensor is detecting, it will stop detecting and the relay will turn off once it has been reset.

Sensor Inactive

A Sensor may be programmed Inactive if it is not being used or needs to be ignored by the AP100. When a Sensor is Inactive, the Sensor will still detect but will not be recognized by the AP100 as a valid Sensor. Programming a Sensor Inactive, moving it, and programming it Active again will eliminate the 14 minute retune timeout period. A sensor that is programmed Inactive does not need to be learned again since it is still in the AP100 memory. To program a Sensor Inactive:

1. Select PROGRAM, press Enter
2. Select SENSOR, press Enter
3. Select ACTIVE, press Enter
4. Select SENSORx, press Enter (x = Sensor being programmed)
5. Select INACTIVE, press Enter
6. Press and hold the Enter button to exit programming

SENSOR PROGRAMMING

Sensor Delete

A Sensor may be deleted from the AP100. However, once a Sensor is deleted, it will have to be reset and learned again before it can be programmed Active. To delete a Sensor:

1. Select PROGRAM, press Enter
2. Select SENSOR, press Enter
3. Select ACTIVE, press Enter
4. Select SENSORx, press Enter (x = Sensor being programmed)
5. Select DELETE, press Enter
6. SENSOR DELETED message will display
7. Hold the Enter button to Exit programming

Sensitivity Adjustment

Each Sensor monitors the X, Y, and Z axis of the earth and activates when the current value of X, Y, or Z is greater than the set range. To make a Sensor more sensitive, this range would be smaller and to make a Sensor less sensitive, this range would be larger. **NOTE: Increasing the sensitivity increases the chance of false detections and decreasing the sensitivity increases the chance that it does not detect a vehicle.**

When changing the sensitivity, change the value by a few points at a time. The direction of each value is:

X = width, Default On = 20

Y = height, Default On = 35

Z = Not used, Default On = 100

Revision 2.3 and Older:

For Revision 2.3 and older, sensitivity only looks at the X,Y,Z On settings. When there is a difference greater than the sensitivity value, the sensor sends a detect signal to the AP100. When the sensitivity value returns to normal, the sensor sends a stop detect signal to the AP100. For example, If the X value = 100, it will send a detect signal if the value exceeds 120 = 100 baseline + 20 default difference. So when a vehicle drives over the sensor, the value might jump to 180, a detect signal is sent because it exceeded 120. When the vehicle leaves and the value returns to 100, it sends a stop detect signal. The defaults for each value are:

X = width, Default = 20

Y = height, Default = 35

Z = Not used, Default = 100

1. Select PROGRAM, press Enter
2. Select SENSOR, press Enter
3. Select SENSE, press Enter
4. Select SENSORx, press Enter (x = Sensor being programmed)
5. Select the X, Y, or Z setting, press Enter
6. Change the setting, press Enter
7. Hold the Enter button to exit programming. The setting does not take affect immediately but will the next time the sensor reports to the AP100 (2 minutes) or if there is an activation.

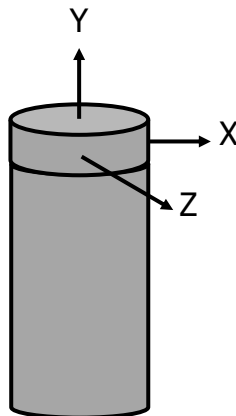

SENSOR PROGRAMMING

Sensitivity Adjustment (Cont)

Revision 2.5 and Newer:

For Revision 2.5 and newer, sensitivity looks at the X,Y,Z ON and OFF settings. When the sensitivity ON difference is greater than the ON setting, the sensor sends a detect signal to the AP100. When the sensitivity OFF difference is less than the OFF setting, the sensor sends a stop detect signal to the AP100. For example, If the X baseline value = 100, it will send a detect signal if the value exceeds 120 = 100 baseline + 20 default difference. So when a vehicle drives over the sensor, the value might jump to 180, a detect signal is sent because it exceeded 120. When the vehicle leaves and the value drops below 105 (Base 100 + Off Difference 5), it sends a stop detect signal. The defaults for each value are:

X = width, On = 20, Off = 5

Y = height, On = 35, Off = 25

Z = Not used, On = 100, Off = 50

1. Select PROGRAM, press Enter
2. Select SENSOR, press Enter
3. Select SENSE, press Enter
4. Select SENSORx, press Enter (x = Sensor being programmed)
5. Select the X, Y, or Z setting, press Enter
6. Change the setting, press Enter
7. Hold the Enter button to exit programming. The setting does not take affect immediately but will the next time the sensor reports to the AP100 (2 minutes) or if there is an activation.

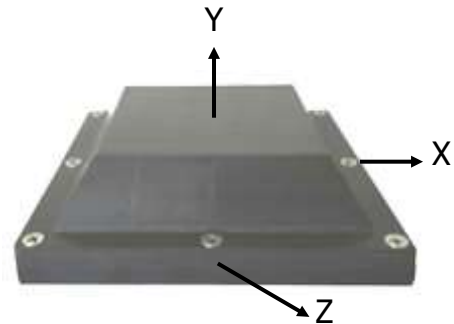
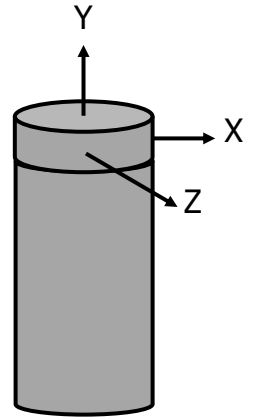

Important: Access One cannot guarantee proper function and detection when the sensitivity is changed.

Notes:

X-Off Difference = 0 - turns the axis off.

Difference is calculated from the baseline

Example: X-Off difference = 5 - will drop detect when there is a 5 point difference from baseline.

Example: X-On difference = 20 - will detect when 20+ point difference from baseline.

SENSOR PROGRAMMING

Sensor Time Schedules (Rev 2.5+)

Up to 10 sensor time schedules can be set using the built-in 7-Day time clock. The sensor time schedules can be used to turn sensor relay functions on and off at certain times of the day or week.

Example 1: An open sensor can be set to activate the open relay on weekdays 8am - 5pm and not activate the open relay on weekends.

Example 2: An outside reverse sensor can be set to work as a reverse 24/7 everyday, and to be an open sensor M-F 8am-5pm. This would allow it to always function as a reverse and to function as an automatic open M-F 8am-5pm.

The clock must be set for Sensor Time Schedules to work. Refer to Setting The Clock on page 17. To program a sensor schedule:

1. Select PROGRAM, press Enter
2. Select SENSOR, press Enter
3. Select T-SCHD, press Enter
4. Select Time Schedule 1-10, press Enter
5. Select ADD to add a time schedule, select DELETE to delete a time schedule.
6. Select SENSOR x, press Enter (x = Sensor being programmed)
7. Select RELAYx, press Enter (x = Relay being programmed)
8. Enter the START TIME hh:mm:ss (24-Hour format)
9. Enter the END TIME hh:mm:ss (24-Hour format)
10. Enter DAY OF WEEK that the schedule is active:
Press Enter to select a day
Press Up to not select a day
Multiple days can be selected
11. Save SCHEDULE? Select YES or NO
12. Press and hold the Enter button to exit programming

Sensor Reset

CAUTION: This step will completely reset the Sensor and require the Sensor to be relearned and activated by the AP100. This step is helpful if a Sensor has been learned but needs to be unlearned for any reason. To reset a Sensor:

1. Unplug the battery
2. Press and hold the Learn button while plugging the battery back on.
3. Continue to hold the Learn button
4. The green LED on the back of the board behind the learn button will begin to blink very fast.
5. Continue to hold the Learn button for 10 seconds while the green LED is blinking fast.
6. Release the Learn button, the green LED should stop blinking and turn on or off each time the Learn button is pressed.



SENSOR PROGRAMMING

Sensor Park Fail (Rev 2.5+)

CAUTION: This is a preliminary feature and has not been fully tested and approved for use. Use of the Park Fail feature is at the installers discretion and Access One will not be responsible for any failure, damage, or other cause if this feature does not work properly.

The Sensor Park Fail allows a vehicle to park over a sensor for an extended amount of time without forcing the sensor to reset after 14 minutes. When a sensor is programmed with the Park Fail On, it will not reset/retune until the vehicle leaves and detect is dropped. Then the sensor will force a reset/retune within the next 15-20 seconds to adjust to the new environment.

Example: Park Fail Off (in normal Reset mode). Vehicle parks over the sensor. After 14 minutes the sensor will reset/retune. It will learn the vehicle as part of the magnetic field, drop detect and allow the gate to close on the vehicle.

Example: Park Fail On. Vehicle parks over the sensor for 2 hours. After 12 minutes, the sensor goes into Park Fail mode and will not allow the sensor to reset/retune at the 14 minute time. After 2 hours when the vehicle leaves, the sensor will see the large magnetic change, and force a reset/retune at that time.

A time limit can be set for the Park Fail to force a reset. For example, Park Fail can be programmed to reset if detection is held for more than 2 hours. This is helpful in case a false detection forces the sensor into a false Park Fail. The time limit is set for hh:mm:ss. Default setting = 00:00:00 for no time limit and will not time out and reset.

To program the Park Fail mode:

1. Select PROGRAM, press Enter
2. Select SENSOR, press Enter
3. Select P-FAIL, press Enter
4. Select SENSORx, press Enter
5. Select ON to turn P-Fail on, select OFF to turn P-Fail off, press Enter
6. Enter the time (hh:mm:ss) for the Park Fail time limit
7. Press and hold Enter to exit programming

ACCESS ONE	STATUS PROGRAM ->
------------	-------------------

PROGRAM	SENSOR -> AP
---------	--------------

SENSOR	P-FAIL -> BACK
--------	----------------

SENSOR	SENSOR1 -> SENSOR2
--------	--------------------

SENSORx	ON -> OFF
---------	-----------

P-FAIL TIME	000000 ->
-------------	-----------

IMPORTANT: A vehicle should never park in the path of a gate as the gate could reset and close on the vehicle.

AP PROGRAMMING

Setting the Clock

The clock on the AP100 is used for tracking system faults and for relay and sensor time schedules (Version 2.5+). The time clock uses the date and time in a 24-hour format. It does not automatically adjust for day lights saving time. When entering the time or date, use the UP and Down buttons to change the number and press Enter to move to the next digit. To set the clock:

1. Select PROGRAM, press Enter
2. Select AP, press Enter
3. Select SET CLOCK, press Enter
4. Enter MMDDYY for the date, press Enter
5. Enter HHMMSS (24-hour format) for time, press Enter
6. Hold the Enter button to exit programming

Fail Mode Programming

The Fail Mode programming allows a relay to be set in a Fail Safe or Fail Secure mode. Fail Safe will activate the relay if there is a sensor failure and release the relay when the fault is cleared. Fail Secure will not activate the relay if there is a sensor failure and will clear when the fault is cleared. **IMPORTANT: Only use the Fail Secure mode on Exit/Open relay.** Do not use the Fail Secure mode on any Reverse or Shadow relay or on an Exit/Open relay that also operates as a Reverse. Default setting is Fail Safe for Relay 1-4. To change the Fail Mode:

1. Select PROGRAM, press Enter
2. Select AP, press Enter
3. Select FAIL MODE, press Enter
4. Select relay to program, press Enter
5. Select SAFE or SECURE, press Enter
6. Hold the Enter button to exit programming

Alarm Programming

There is a built-in alarm on the AP100 that is sounded when there is a fault in the system. For example if Sensor1 fails due to a communication failure or even a bad battery, the AP100 will recognize the fault within 60 seconds and activate a fault mode for the sensor. This mode will activate the alarm if the alarm is set to on = default. This programming will turns the alarm on, off, and resets the Fault Status Log. Default setting is On. To change the setting or clear the Fault Status Log:

1. Select PROGRAM, press Enter
2. Select AP, press Enter
3. Select ALARM, press Enter
4. Select function, press Enter
5. Hold the enter button to exit programming

Function	Action
ON	Activates alarm during a fault
OFF	Does not activate the alarm during a fault
CLEAR F	Clears & resets the Fault Log in status

AP PROGRAMMING

AP100 System Reset

CAUTION: This step will completely reset the AP100. Once the system reset is complete, the AP100 will be in a new factory default setting and will require all Sensors to be relearned and activated, and all other settings such as relay activations to be reprogrammed. To system reset the AP100:

1. Select PROGRAM, press Enter
2. Select AP, press Enter
3. Select SYST RESET, press Enter
4. Press Enter to confirm, or press Up to cancel
5. LCD will show RESETTING
6. LCD will return to home screen when System Reset is complete

Changing the Unit ID

For applications where two or more controllers will be used close to each other, the Unit IDs should be different to make sure that an AP100 does not pick up sensors programmed to a different AP100 close by. **This should be done before any sensors are learned to an AP100.** Once the Unit ID is changed on the AP100, it will assign that ID to each sensor that it learns.

Each time the Unit ID is changed, it increases on digit. For example, Unit ID 1301010005 will increase to 1301020005. It is the middle number that changes. If multiple AP100s are close to each other, then the Unit ID needs to be changed on each AP100.

The current Unit ID can be displayed in the STATUS menu under CONTROLLER. To change the Unit ID:

1. Select PROGRAM, press Enter
2. Select AP, press Enter
3. Select CHANGE ID, press Enter
4. Select YES=Enter or NO=Up
5. The Unit ID will automatically change up one digit. Example: 1301010005 will increase to 1301020005. (The middle number changes)
6. Hold the Enter button to exit programming

ACCESS ONE	STATUS PROGRAM ->
PROGRAM	AP -> BACK
AP	CHANGE ID -> T-SCHD
Change to new ID YES=Enter	NO=up
The Device ID: 13010 <u>2</u> 0005	

NOTE: The Unit ID must be changed before any sensors are learned to the AP100. If a sensor has been learned by the AP100 before changing the Unit ID, the sensor will need to be reset and then relearned after the new Unit ID.

AP PROGRAMMING

Relay Time Schedules (Rev 2.5+)

Up to 10 Relay Time Schedules can be set using the built-in 7-Day time clock. The relay time schedules can be used to turn relays on and off at certain times of the day or week.

Example 1: A relay time schedule with a start time 8:00, end time 17:00, MTWTF will activate and hold the relay on weekdays 8am - 5pm and not automatically activate the relay on weekends.

The clock must be set for Relay Time Schedules to work. Refer to Setting The Clock on page 17. To program a sensor schedule:

1. Select PROGRAM, press Enter
2. Select AP, press Enter
3. Select T-SCHD, press Enter
4. Select Time Schedule 1-10, press Enter
5. Select ADD to add a time schedule, select DELETE to delete a time schedule.
6. Select RELAYx, press Enter (x = Relay being programmed)
7. Enter the START TIME hh:mm:ss (24-Hour format)
8. Enter the END TIME hh:mm:ss (24-Hour format)
9. Enter DAY OF WEEK that the schedule is active:
Press Enter to select a day
Press Up to not select a day
Multiple days can be selected
11. Save SCHEDULE? Select YES or NO
12. Press and hold the Enter button to exit programming

OPERATING INSTRUCTIONS

Sensor Detection

To activate a sensor, metal must be present in the sensor detection field. The larger the mass of metal, the better detection the sensor will have. Special metals such as stainless steel or aluminum will not activate the sensor. Smaller metal items such as motorcycles may need to drive over the sensor to be detected.

The front and back detection is reduced when the sensor is inactive and increased when in detection mode. For example, a vehicle approaching the sensor straight on will not be detected until 1-2 feet from the sensor. But when the sensor detects the vehicle, it expands the depth to 2-3 feet from the sensor, or 4-6 feet total depth. The detection width is always at full detection distance.

There is a 1-2 second delay from the sensor detecting and the relay activating. This is normal to help prevent false activations from the earth's magnetic spikes. The sensor must see a full second detection before sending the detect signal and the sensor must be cleared for a full second before sending the off signal.

Sensor Automatic Retune

If a sensor is programmed with the Reset feature On and is held detecting for more than 14 minutes, it will automatically retune itself and drop the detection. This is helpful for applications that have intermittent sensor lockup issues. However, a vehicle cannot park in the path of a gate as the sensor will detect the vehicle, retune after 14 minutes, and then allow the gate to close on the parked car. **DO NOT PARK IN THE PATH OF THE GATE!**

Sensor Park Fault

If a sensor is programmed with the Park Fail feature On and is held detecting for more than 12 minutes, it will create a sensor park fault. After 12 minutes, the sensor will generate the fault and the fault will continue to hold the gate open until the sensor is cleared. Once the sensor is cleared (vehicle drives away), it will reset itself to the current conditions and clear the fault allowing the gate to close.

This feature will also occur if a sensor is moved after the sensor has been programmed Active. In this case, the sensor will not reset and clear the fault since there is not a vehicle present. To reset the sensor, simply program the sensor Inactive and then Active again.

OPERATING INSTRUCTIONS

Status Menu

The status menu on the Access Point Relay Board allows the user or installer to view the current status of the system including relay status, sensor status, controller status, fault status, and clock status. To access the status menu, use the Up, Down, Enter buttons to move the cursor to STATUS and press ENTER.

Relay Status

The relay status shows the current state of for relay 1 - 4. The current state is displayed as TURNED ON or TURNED OFF. To view the relay status:

1. Select STATUS, press Enter
2. Select RELAY, press Enter
3. Select the desired relay, press Enter
4. Relay status will be displayed

Sensor Status

Sensor status is a quick way to see if a sensor has been learned and programmed Active. If a sensor is Active, the status will display Active under the selected sensor. If it is Inactive, the status will display Inactive under the selected sensor. To check the state of a sensor:

1. Select STATUS, press Enter
2. Select SENSOR, press Enter
3. Select the desired sensor, press Enter
4. ACTIVE, INACTIVE or NOT ASSIGNED status will be displayed

Controller Status

Controller status displays the Model and Firmware Version of the AP100 followed by the Unit ID. To view the controller status:

1. Select STATUS, press Enter
2. Select CONTRL, press Enter
3. Model and Firmware Version will be displayed on the first screen and then automatically display the Unit ID on the second screen a few seconds later.

Faults Status

Fault status is a log of the last ten faults. It tracks the date, time, and sensor or controller that failed. To view the fault log:

1. Select STATUS, press Enter
2. Select FAULT, press Enter
3. Use the UP and DOWN buttons to scroll through the faults

Clock Status

Clock status displays the current time and date that has been set on the AP100. To view the clock status:

1. Select STATUS, press Enter
2. Select CLOCK, press Enter
3. The date and time will be displayed

Default Settings

Function/Action	Default Setting
Relay Action (Relay 1-4)	None (off)
Sensor Sensitivity	X-ON=20, X-OFF=5 Y-ON=35, Y-OFF=25 Z-ON=100, Z-OFF=50
Sensor Time Schedules	None - Not set
Sensor Reset Mode	On
Sensor Park Mode	Off
Clock/Date Setting	Not set
Fail Mode	Fail Safe
Alarm	ON
Unit ID	1301010005
Relay Time Schedules	None - Not set

Specifications

Specifications	
Number of sensors per system	10
LCD display	Backlit, 16 character, 2-line
7-Day Plus time clock	Dates, Time, Days
Time clock settings	Time, Day, Date
Relay functions	Momentary, Latch, Unlatch, Toggle
Number of relays	4
Relay output	NO, NC, C
Sensor Park Fail Mode	On = Maintains relay contact
Sensor Reset Mode	On = Drops relay contact after 15 minutes
Status Reports	Sensor, Relay, Faults, System
Sensitivity Adjustment	X, Y, Z axis
Sensor battery life expectancy	1 - 3 years
Sensor battery	3.6V, 19AH Lithium
Power input	12-24 VAC or VDC
Current draw @ 12VDC	63mA no relay, 94mA one active relay
Current draw @ 24VDC	29mA no relay, 49mA one active relay
Fuse	1A, Time Lag (Slo-Blo), 250V
AP100 Dimensions	5.50" wide, 4.25" high, 1" deep
S200P Dimensions	5" high, 1.90" wide
S600SM Dimensions	6" x 6" wide, 1.50" high

TROUBLESHOOTING

SYMPTOM:	POSSIBLE SOLUTION:
AP100 does not appear to have power	<ol style="list-style-type: none"> 1. If the AP100 is powered by a gate operator, make sure the operator power is on 2. Check the connections for clean tight connections. 3. Check the fuse on the AP100. 4. Test the power level using a VOM meter at the supply power. 5. Test the power level using a VOM meter at the AP100.
Sensor does not appear to have power	<ol style="list-style-type: none"> 1. Make sure the battery is tightly plugged on 2. Test the battery power using a VOM meter 3. Battery power should be between 3.3VDC - 3.6VDC 4. Replace the battery
Sensor will not learn	<ol style="list-style-type: none"> 1. Make sure the AP100 antenna is connected 2. Make sure the AP100 blue radio chip is pressed in fully and tight 3. Make sure the AP100 is in learn search mode 4. Make sure the sensor battery is tightly plugged on 5. Press the learn button a few times. The green LED should turn On/Off. 6. Reset the sensor 7. Reset the AP100 - Caution this will completely clear the AP100 and all sensors
AP100 learned two Sensors as the same Sensor Number. Example: Learned Sensor1 and Sensor2 both as Sensor1	<ol style="list-style-type: none"> 1. Program the shared Sensor number ACTIVE. 2. Delete the shared Sensor number. 3. Reset the Sensors and relearn.
AP100 does not see Sensor detect	<ol style="list-style-type: none"> 1. Make sure the Sensor has been programmed ACTIVE 2. Mount the AP100 antenna as high as possible and in a clear line of sight to the sensor. Tip: From your hands & knees, look from the ground to the antenna. The full antenna should be visible and not blocked from each sensor.
Relay is on and AP100 LCD shows SENSOR FAIL	<ol style="list-style-type: none"> 1. AP100 is not communicating with the sensor 2. Make sure the antenna connections are tight and the blue radio chip is tight. 3. Mount the AP100 antenna higher to get better communication 4. Make sure the sensor is flush with the roadway and not below the road surface.
All relays are on and the AP100 LCD shows AP FAIL	<ol style="list-style-type: none"> 1. AP100 is not communicating with any of the sensors. 2. Make sure the AP100 blue radio chip is pressed in fully and tight and all antenna connections are tight. 3. Mount the AP100 antenna higher and in a clear line of sight to each sensor 4. Move the sensors closer to make sure they communicate with the AP100
Sensor detects and shows on LCD but does not activate relay	<ol style="list-style-type: none"> 1. Make sure that Sensor is programmed to a relay. 2. Make sure the relay is programmed to a function other than NONE. None is the default.

LIMITED WARRANTY

You MUST read, understand and agree with ALL items in this limited warranty!

Access One Technologies warrants this product to be free of defects in workmanship and materials for a period of (1) one year from the date of purchase. Access One Technologies reserves the right of final determination to the cause of any defect or failure. Access One Technologies shall, at its option, either repair or replace this product if returned freight prepaid to Access One Technologies during the warranty period. This warranty does not include freight, taxes, duties, or installation and service expenses. This warranty will not apply to circumstances which are considered beyond our control including: incorrect installation or application, vandalism, misuse, acts of God (lightning, insects and rodents, floods, etc.), power surges, or improper system installation.

The warranty set forth above is exclusive and no other warranty, whether written or oral, is expressed or implied. Access One Technologies specifically disclaims any implied warranties or merchantability and fitness for a particular purpose. The remedies provided herein are the buyer's sole and exclusive remedies. In no event shall Access One Technologies be liable for direct, indirect, special, incidental or consequential damages (including loss of profits or property), whether based on contract, tort or any other legal theory. Access One Technologies can not be held responsible for damage or injury caused by improper, erroneous or unreasonable use or installation. The installer and end user agree to assume all responsibility for ALL liability in use of this product releasing Access One Technologies of all liability.

IMPORTANT: It is the joint responsibility of the installer and end user to verify the system is properly configured for its intended use including proper safety devices. Failure to comply with these guidelines may create a dangerous situation and will void any and all warranties. All users must follow and understand:

1. The user and installer have fully read, understand, and abiding by the Safety Information and Restrictions and Limitations set forth in this manual.
2. A moving gate can cause serious injury or death. Read and follow all installation manuals, reference manuals, and warning label instructions.
3. Vehicular gates are for vehicles only. Pedestrians must use a separate entrance. Keep all pedestrian traffic away from any vehicular gate. No one should cross the path of a moving gate.
4. Never allow children to operate or play with gate controls. Never allow children to play in the area of a gate system.
5. Access control devices must be placed far enough from moving gates to prevent the user from coming in contact with the gate while operating the controls.
6. All activating devices must be installed in a clear line-of-sight with the gate and its travel.
7. Activating devices must be installed a minimum of 10 feet away from the gate.
8. Outdoor or easily accessible controls shall have a security feature to prevent unauthorized use.
9. Be sure to mount all operating devices clearly out of reach of through gates.
10. Any required contact edges and/or photo beams must be installed before placing this system into operation.
11. Make sure all residents and users are familiar with the proper use of this equipment and its potential hazards.
12. Protect against all pinch and entrapment points. If entrapment and pinch points can not be protected, **DO NOT install this equipment.**
13. Read and follow all U.L. and Safety Standards before installing any access device.
14. Installation, service and maintenance must be carried out by qualified personnel.

In order to install and use this system, the installer and end user must understand and be in FULL unconditional agreement with all stipulations outlined above. **If you are not in FULL agreement, do not put the system into operation.** If the system is put into operation, this will confirm that you are in FULL unconditional agreement with all of the above stipulations.

Customer's Signature

Date

Installer's Signature

Date

Serial Number: _____ Date Installed: _____

Installed By: _____

Installation Address: _____

City: _____ State: _____ Zip: _____

Customer Name: _____

For the warranty to be valid, a completed and signed copy must be mailed or emailed to Access One Technologies.



www.AccessOneTechnologies.com