

# INDUSTRIAL DC VEHICULAR SLIDE GATE OPERATOR

## INSTALLATION MANUAL

Models **IHSL24UL** | **INSL24UL**

EXTERNAL  
SAFETY DEVICES  
REQUIRED. SEE SAFETY  
SECTION FOR UL325  
ENTRAPMENT PROTECTION  
REQUIREMENTS



- THIS PRODUCT MUST BE INSTALLED AND SERVICED IN ACCORDANCE WITH THIS MANUAL BY A TRAINED GATE SYSTEMS TECHNICIAN ONLY.
- This operator is for use on vehicular passage gates ONLY and not intended for use on pedestrian passage gates.
- **IHSL24UL** and **INSL24UL** are intended for use in Class II, III, and IV vehicular slide gate applications.
- Visit [LiftMaster.com](http://LiftMaster.com) to locate a professional installing dealer in your area.
- This gate operator is compatible with myQ® and Security+ 2.0® accessories.

Access installation and technical support guides or register this product

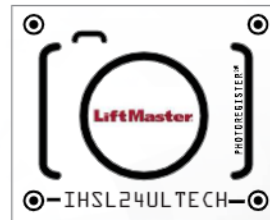

1. Take a photo of the camera icon including the points (○).

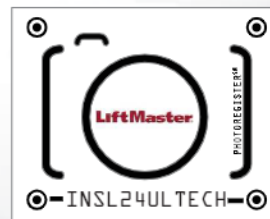

2. Send it in by texting the photo to 71403.



LiftMaster  
300 Windsor Drive  
Oak Brook, IL 60523

# LiftMaster®

# TABLE OF CONTENTS

<b>SAFETY</b>	<b>2</b>	Manual Disconnect .....	29
Safety Symbol and Signal Word Review.....	2	Reset Button .....	29
Usage Class .....	3	Operator Alarm .....	30
UL325 Entrapment Protection Requirements .....	3	Remote Control.....	30
Safety Installation Information.....	4	<b>ACCESSORY WIRING</b>	<b>31</b>
Role of Dealers, Installers, and Trained Gate System Technicians .....	4	External Control Devices.....	31
Role of End Users/Home Owners .....	4	Locks .....	32
Gate Construction Information.....	5	Miscellaneous Wiring.....	32
<b>INTRODUCTION</b>	<b>6</b>	<b>EXPANSION AND RELAY ADAPTER BOARDS</b>	<b>33</b>
Carton Inventory .....	6	Expansion and Relay Adapter Boards Overview.....	33
Operator Specifications.....	7	Auxiliary Relays .....	34
Site Preparation .....	8	Wiring Accessories to the Expansion Board .....	35
<b>INSTALLATION</b>	<b>9</b>	<b>MAINTENANCE</b>	<b>36</b>
Step 1 Install the Operator.....	9	Important Safety Instructions .....	36
Step 2 Attach the Chain .....	11	Maintenance Chart.....	37
Step 3 Install Entrapment Protection .....	12	Batteries.....	37
Step 4 Earth Ground Rod.....	15	Drive Train .....	37
Step 5 Power Wiring.....	15	<b>TROUBLESHOOTING</b>	<b>38</b>
Step 6 Connect Batteries .....	17	Diagnostic Codes.....	38
Step 7 Dual Gate Setup.....	18	Control Board LEDs .....	39
Step 8 Close and Secure the Door.....	20	Troubleshooting Chart .....	40
Step 9 Install Warning Signs .....	20	<b>SOLAR PANELS</b>	<b>43</b>
<b>ADJUSTMENT</b>	<b>21</b>	Solar Panel(s) .....	43
Limit, Speed, and Force Adjustment.....	21	<b>REPAIR PARTS</b>	<b>47</b>
Set the Initial Limits, Speed, and Force .....	21	<b>ACCESSORIES</b>	<b>48</b>
Speed Control.....	22	<b>WARRANTY</b>	<b>50</b>
Fine Tune the Force .....	22	<b>APPENDIX</b>	<b>51</b>
Adjust the Limits.....	23	SAMS Wiring With Relays Not Energized .....	51
Obstruction Test .....	23	Dual Gate Settings .....	51
<b>PROGRAMMING</b>	<b>24</b>	Manual Adjustments with a Remote Control .....	52
Remote Controls (Not Provided) .....	24	Wiring Diagram.....	53
LiftMaster Internet Gateway (not provided).....	25	Diagnostic Codes Table .....	55
CAPXLV Connected Access Portal.....	25	Site Planning Safety Checklist .....	57
myQ® Business™.....	26	Contact Information .....	60
Erase All Transmitter and Keypad Codes .....	26		
Erase Limits.....	26		
Constant Pressure Override (CPO) .....	26		
Gate Hold Open Feature .....	26		
To Remove and Erase Monitored Entrapment Protection Devices.....	26		
<b>OPERATION</b>	<b>27</b>		
Gate Operator Setup Examples .....	27		
Control Board Overview .....	28		

## SAFETY

### Safety Symbol and Signal Word Review

When you see these Safety Symbols and Signal Words on the following pages, they will alert you to the possibility of **Serious Injury or Death** if you do not comply with the warnings that accompany them. The hazard may come from something mechanical or from electric shock. Read the warnings carefully.

When you see this Signal Word on the following pages, it will alert you to the possibility of damage to your gate and/or the gate operator if you do not comply with the cautionary statements that accompany it. Read them carefully.

#### IMPORTANT NOTE:

- *BEFORE attempting to install, operate or maintain the operator, you must read and fully understand this manual and follow all safety instructions.*
- *DO NOT attempt repair or service of your gate operator unless you are a Trained Gate Systems Technician.*

 **WARNING:** This product can expose you to chemicals including lead, which are known to the State of California to cause cancer or birth defects or other reproductive harm. For more information go to [www.P65Warnings.ca.gov](http://www.P65Warnings.ca.gov).

 **WARNING**

MECHANICAL

 **WARNING**

ELECTRICAL

 **CAUTION**

## Usage Class

### Class II - Commercial/General Access Vehicular Gate

A vehicular gate operator (or system) intended for use in a commercial location or building such as a multi-family housing unit (five or more single family units), hotel, garages, retail store, or other buildings accessible by or servicing the general public.

### Class III - Industrial/Limited Access Vehicular Gate

A vehicular gate operator (or system) intended for use in an industrial location or building such as a factory or loading dock area or other locations not accessible by or intended to service the general public.

### Class IV - Restricted Access Vehicular Gate Operator

A vehicular gate operator (or system) intended for use in a guarded industrial location or building such as an airport security area or other restricted access locations not servicing the general public, in which unauthorized access is prevented via supervision by security personnel.

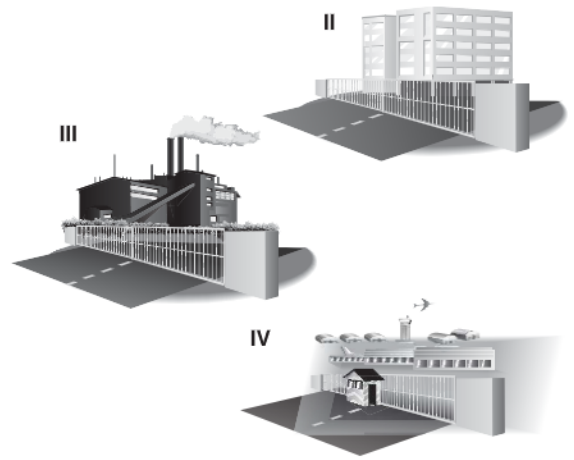

## UL325 Entrapment Protection Requirements

### Definitions

**ENTRAPMENT:** The condition when a person is caught or held in a position that increases the risk of injury.

**SLIDE GATE ENTRAPMENT ZONE:** An entrapment zone exists if at any point during travel, the gap between the gate and any opposing fixed edge or surface such as posts, walls, pillars, columns, or the operator itself, is less than 16" (406 mm) in a location up to 6 ft. (1.8 m) above grade.

**INDEPENDENT MONITORED ENTRAPMENT PROTECTION DEVICE:** An entrapment protection device is independent if it is a different type (photoelectric sensors, edge device, inherent protection device) from the other devices in the same entrapment zone.

Use the *Site Planning Safety Checklist* in the appendix to identify entrapment zones found in your installation.

### Requirements

- A **minimum of two** independent monitored entrapment protection devices are required to be installed at each entrapment zone.
- It is the responsibility of the installer to install external monitored entrapment protection devices for **each entrapment zone**.
- The operator will only operate with a **minimum of two** independent monitored entrapment protection devices installed in each direction; two in the open direction and two in the closed direction.

***This operator has an inherent entrapment protection device built-in. The installer MUST provide one additional entrapment protection device for each entrapment zone.***

Acceptable entrapment protection device types include:

- Inherent (built into the operator)
- LiftMaster monitored external photoelectric sensors, see page 48 for acceptable sensors.
- LiftMaster monitored external edge sensors, see page 48 for acceptable sensors.

## IMPORTANT SAFETY INSTRUCTIONS

### WARNING

To reduce the risk of INJURY or DEATH:

- READ AND FOLLOW ALL INSTRUCTIONS.
- NEVER let children operate or play with gate controls. Keep the remote control away from children.
- ALWAYS keep people and objects away from the gate. NO ONE SHOULD CROSS THE PATH OF THE MOVING GATE.
- **Test the gate operator monthly. The gate MUST reverse on contact with an object or reverse when an object activates the noncontact sensors. After adjusting the speed, force, or the limit of travel, retest the gate operator. Failure to adjust and retest the gate operator properly can increase the risk of INJURY or DEATH.**
- Use the manual release ONLY when the gate is not moving.
- KEEP GATES PROPERLY MAINTAINED. Read this manual. Have a Trained Gate Systems Technician make repairs to gate hardware.
- The entrance is for vehicles ONLY. Pedestrians MUST use separate entrance.

• **SAVE THESE INSTRUCTIONS.**

## Safety Installation Information

1. Vehicular gate systems provide convenience and security. Gate systems are comprised of many component parts. The gate operator is only one component. Each gate system is specifically designed for an individual application.
2. Gate operating system designers, installers and users must take into account the possible hazards associated with each individual application. Improperly designed, installed or maintained systems can create risks for the user as well as the bystander. Gate systems design and installation must reduce exposure to potential hazards.
3. A gate operator can create high levels of force in its function as a component part of a gate system. Therefore, safety features must be incorporated into every gate system design. Specific safety features include:
  - Edges Sensors (contact)
  - Guards for Exposed Rollers
  - Photoelectric Sensors
  - Screen Mesh
  - Instructional and Precautionary Signage
4. Install the gate operator only when:
  - a. The operator is appropriate for the construction and the usage class of the gate.
  - b. All openings of a horizontal slide gate are guarded or screened from the bottom of the gate to a minimum of 6 feet (1.8 m) above the ground to prevent a 2-1/4 inches (6 cm) diameter sphere from passing through the openings anywhere in the gate, and in that portion of the adjacent fence that the gate covers in the open position.
  - c. All exposed pinch points are eliminated or guarded, and guarding is supplied for exposed rollers.
5. The gate operator is intended for installation only on gates used for vehicles. Pedestrians must be supplied with a separate access opening. The pedestrian access opening shall be designed to promote pedestrian usage. Locate the pedestrian access such that persons will not come in contact with the vehicular gate during the entire path of travel of the vehicular gate.
6. The gate must be installed in a location so that enough clearance is supplied between the gate and adjacent structures when opening and closing to reduce the risk of entrapment.
7. The gate must be properly installed and work freely in both directions prior to the installation of the gate operator.
8. Permanently mounted access controls intended for users to activate, must be located at least 6 feet (1.8 m) away from any moving part of the gate and where the user is prevented from reaching over, under, around or through the gate to operate the controls. Outdoor or easily accessible controls shall have a security feature to prevent unauthorized use. Exception: Emergency access controls only accessible by authorized personnel (e.g. fire, police) may be placed at any location in the line-of-sight of the gate.
9. For a gate operator utilizing a Stop and/or Reset button, it must be located in the line-of-sight of the gate. Activation of the reset control shall not cause the operator to start.
10. A minimum of two (2) WARNING SIGNS shall be installed in the area of the gate. Each warning sign is to be visible by persons located on the side of the gate on which the sign is installed.
11. For a gate operator utilizing a non-contact sensor:
  - a. See Install Entrapment Protection section for placement of non-contact sensor for each type of application.
  - b. Care shall be exercised to reduce the risk of nuisance tripping, such as when a vehicle trips the sensor while the gate is still moving.
  - c. One or more non-contact sensors shall be located where the risk of entrapment or obstruction exists, such as the perimeter reachable by a moving gate or barrier.
12. For a gate operator utilizing a contact sensor such as an edge sensor:
  - a. One or more contact sensors shall be located where the risk of entrapment or obstruction exists, such as at the leading edge, trailing edge and post mounted both inside and outside of a vehicular horizontal slide gate.
  - b. A hard wired contact sensor shall be located and its wiring arranged so the communication between the sensor and the gate operator is not subject to mechanical damage.
  - c. A wireless device such as one that transmits radio frequency (RF) signals to the gate operator for entrapment protection functions shall be located where the transmission of the signals are not obstructed or impeded by building structures, natural landscaping or similar obstruction. A wireless device shall function under the intended end-use conditions.

## Role of Dealers, Installers, and Trained Gate System Technicians

- Ensure entire system being designed manufactured and installed meets all applicable standards and codes including UL 325 and ASTM F2200.
- Demonstrate the basic functions and safety features of the gate system to owners/end users/general contractors, including how to turn off power and how to operate the manual disconnect feature.
- Leave safety instructions, product literature, installation manual and maintenance manual with end user.
- Explain to the owners the importance of testing by a trained gate system technician that includes a routine re-testing of the entire system including the entrapment protection devices, and explain the need for the owners to insure that this testing is performed monthly.

## Role of End Users/Home Owners

- Contact a trained gate systems technician to maintain and repair the gate system (End users should never attempt to repair the gate system).
- Retain and utilize the installation manual and maintenance and important safety instructions; see page 36.
- Routinely check all gate operator functions and gate movement.
- Discontinue use if safety systems operate improperly, the gate is damaged, or the gate is difficult to move. Contact trained gate systems technician to repair the gate system.
- Prominently display and maintain warning signs on both sides of the gate.

## Gate Construction Information

Vehicular gates should be installed in accordance with ASTM F2200: Standard Specification for Automated Vehicular Gate Construction. For a copy, contact ASTM directly at 610-832-9585 or [www.astm.org](http://www.astm.org).

### 1. General Requirements

- 1.1 Gates shall be constructed in accordance with the provisions given for the appropriate gate type listed, refer to ASTM F2200 for additional gate types.
- 1.2 Gates shall be designed, constructed and installed to not fall over more than 45 degrees from the vertical plane, when a gate is detached from the supporting hardware.
- 1.3 Gates shall have smooth bottom edges, with vertical bottom edged protrusions not exceeding 0.50 inches (12.7 mm) when other than the exceptions listed in ASTM F2200.
- 1.4 The minimum height for barbed tape shall not be less than 8 feet (2.44 m) above grade and for barbed wire shall not be less than 6 feet (1.83 m) above grade.
- 1.5 An existing gate latch shall be disabled when a manually operated gate is retrofitted with a powered gate operator.
- 1.6 A gate latch shall not be installed on an automatically operated gate.
- 1.7 Protrusions shall not be permitted on any gate, refer to ASTM F2200 for Exceptions.
- 1.8 Gates shall be designed, constructed and installed such that their movement shall not be initiated by gravity when an automatic operator is disconnected, in accordance with the following.
- 1.8.1 Vehicular horizontal slide gate shall not result in continuous, unimpeded movement in either lineal direction of its travel.
- 1.9 For pedestrian access in the vicinity of an automated vehicular gate, a separate pedestrian access shall be provided or available. The pedestrian access shall be installed in a location such that a pedestrian shall not come in contact with a moving vehicular access gate during the entire path of travel of the vehicular gate. A pedestrian gate shall not be incorporated into an automated vehicular gate panel.

### 2. Specific Applications

- 2.1 Any non-automated gate that is to be automated shall be upgraded to conform to the provisions of ASTM F2200.
- 2.2 This specification shall not apply to gates generally used for pedestrian access and to vehicular gates not to be automated.
- 2.3 When the gate operator requires replacement, the existing gate shall be upgraded to conform to the provisions of ASTM F2200.
- 2.4 When the gate of an automated gate system requires replacement, the new gate shall conform to the provisions of ASTM F2200.

### 3. Vehicular Horizontal Slide Gates

- 3.1 The following provisions shall apply to Class I, Class II and Class III vehicular horizontal slide gates:
  - 3.1.1 All weight bearing exposed rollers 8 feet (2.44 m), or less, above grade shall be guarded or covered.
  - 3.1.2 All openings shall be designed, guarded, or screened from the bottom of the gate to the top of the gate or a minimum of 6 ft. (1.83 m) above grade, whichever is less, to prevent a 2 1/4 in. (57 mm) diameter sphere from passing through the openings anywhere in the gate, and in that portion of the adjacent fence that the gate covers in the open position. The gate panel shall include the entire section of the moving gate, including any back frame or counterbalance portion of the gate.
  - 3.1.3 A gap, measured in the horizontal plane parallel to the roadway, between a fixed stationary object nearest the roadway, (such as a gate support post) and the gate frame when the gate is in either the fully open position or the fully closed position, shall not exceed 2-1/4 inches (57 mm). Exception: All other fixed stationary objects greater than 16 in. (406 mm) from the gate frame shall not be required to comply with this section.
  - 3.1.4 Positive stops shall be required to limit travel to the designed fully open and fully closed positions. These stops shall be installed at either the top of the gate, or at the bottom of the gate where such stops shall horizontally or vertically project no more than is required to perform their intended function.
  - 3.1.5 All gates shall be designed with sufficient lateral stability to assure that the gate will enter a receiver guide, refer to ASTM F2200 for panel types.
- 3.2 The following provisions shall apply to Class IV vehicular horizontal slide gates:
  - 3.2.1 All weight bearing exposed rollers 8 feet (2.44 m), or less, above grade shall be guarded or covered.
  - 3.2.2 Positive stops shall be required to limit travel to the designed fully open and fully closed positions. These stops shall be installed at either the top of the gate, or at the bottom of the gate where such stops shall horizontally or vertically project no more than is required to perform their intended function.

# INTRODUCTION

## Carton Inventory

**NOT SHOWN:** Documentation Packet, Chain #40 - 30 feet with master link (INSL24UL ONLY), Chain #50 - 25 feet with master link (IHSL24UL ONLY), Eye Bolt Kit, Antenna

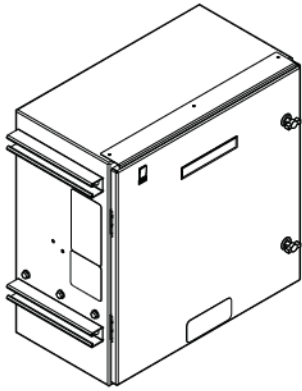

Operator Front

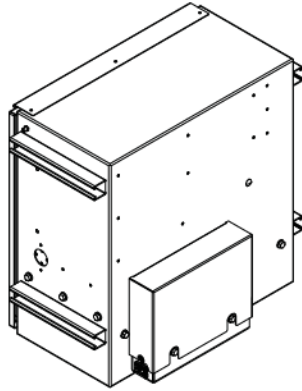

Operator Back



Warning Signs (2)



Installation Manual



Gate Brackets

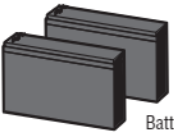

Battery 12 Vdc 7AH (2)

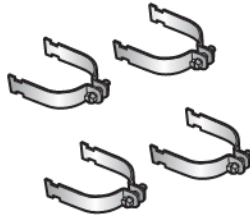

Clamps

### MONITORED ENTRAPMENT PROTECTION DEVICES

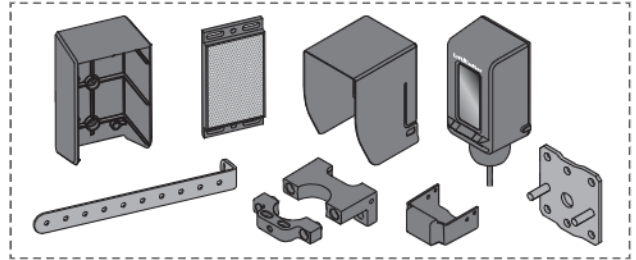

LiftMaster Monitored Retro-Reflective Photoelectric Sensor Model LMRRUL (1)

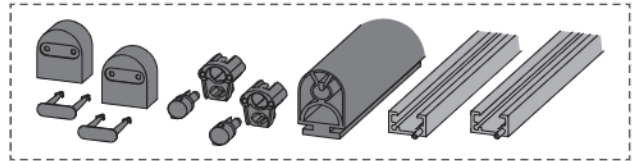

5 ft. Edge Sensor Kit Model S505AL (1)

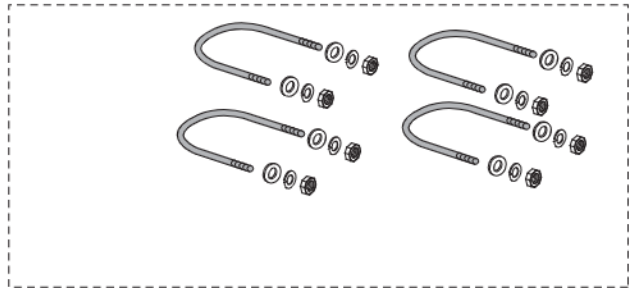

Hardware

# INTRODUCTION

## Operator Specifications

	INSL24UL	IHSL24UL
<b>Usage Classification</b>	Class II, III, and IV	
<b>Main AC Supply</b>	120 Vac, 9.3 Amps including Accessory Outlets OR 240 Vac, 1.8 Amps	120 Vac, 13.0 Amps including Accessory Outlets OR 240 Vac, 3.7 Amps
<b>Optional Transformer Kit</b>	When Optional Transformer Kit Model 3PHCONV is installed in the field, operator is rated 208/240/480/575 VAC, 5.2/4.5/2.3/1.9 A, 60 Hz, 1 PH	
<b>System Operating Voltage</b>	24 Vdc Transformer Run / Battery Backup	24 Vdc Transformer Run / Battery Backup
<b>Accessory Power</b>	24 Vdc, 1A max. for ON + SW (switched)	24 Vdc, 1A max. for ON + SW (switched)
<b>Solar Power Max</b>	24 Vdc at 60 watts max.	24 Vdc at 60 watts max.
<b>Maximum Gate Weight</b>	2,200 lbs. (998 kg)	5,500 lbs. (2,495 kg)
<b>Minimum Gate Travel Distance</b>	4 feet (1.2 m)	4 feet (1.2 m)
<b>Maximum Gate Travel Distance</b>	70 feet (21.34 m)	90 feet (27.43 m)
<b>Maximum Gate Travel Speed</b>	1 ft./sec.	1 ft./sec.
<b>Maximum Daily Cycle Rate</b>	Continuous for line voltage, not continuous for solar	Continuous for line voltage, not continuous for solar
<b>Maximum Duty Cycle</b>	Continuous	Continuous
<b>Operating Temperature</b>	Without Heater: -20°C to 60°C (-4°F to 140°F) With Optional Heater: -40°C to 60°C (-40°F to 140°F)	Without Heater: -20°C to 60°C (-4°F to 140°F) With Optional Heater: -40°C to 60°C (-40°F to 140°F)
<b>120VAC accessory power outlets</b>	6 amps When the 3PHCONV kit is used, the outlets are rated 1 Amp	6 amps When the 3PHCONV kit is used, the outlets are rated 1 Amp
<b>External Entrapment Protection Device Inputs</b>	Control Board - up to 2 close entrapment protection devices and 1 open entrapment protection device. Expansion board - up to 3 entrapment protection devices configurable to either the close or open direction and up to 8 edge sensors when using the wireless edge sensor kit model LMWEKITU and LMWETXU.	Control Board - up to 2 close entrapment protection devices and 1 open entrapment protection device. Expansion board - up to 3 entrapment protection devices configurable to either the close or open direction and up to 8 edge sensors when using the wireless edge sensor kit model LMWEKITU and LMWETXU.

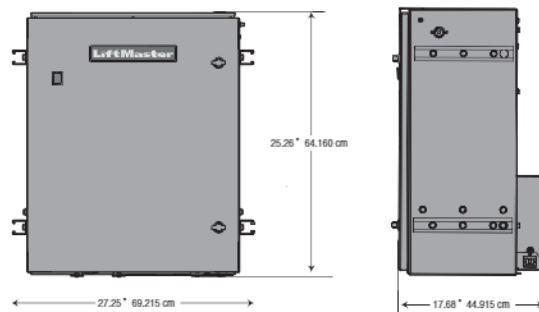

# INTRODUCTION

## Site Preparation

Check the national and local building codes **BEFORE** installation. Refer also to the *Site Planning Safety Checklist* in the Appendix.

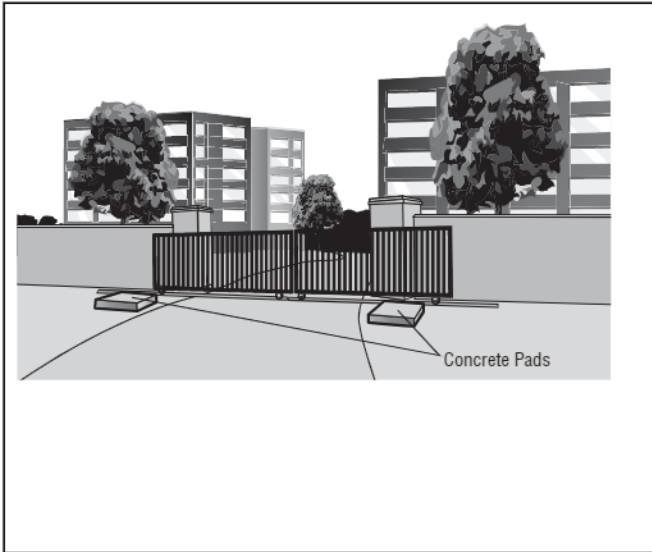

## Safety

Entrapment protection devices are required to protect against any entrapment or safety conditions encountered in your gate application. Install a warning sign (two provided) on the inside and outside of the property, where easily visible.



## Gate

Gate must be constructed and installed according to ASTM F2200 standards (refer to page 4). Gate must fit specifications of operator (refer to specifications).

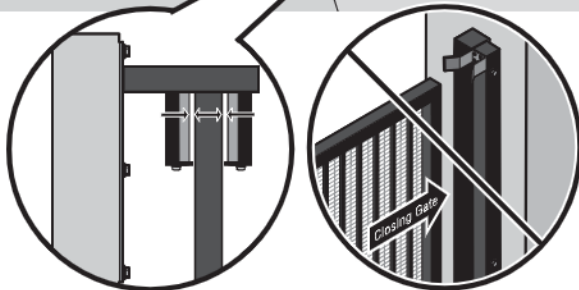
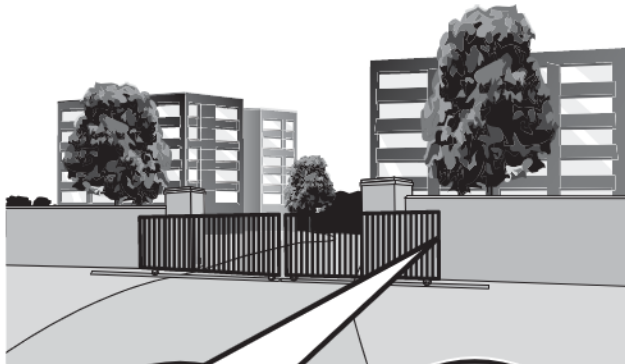

**SAFETY CATCH ROLLERS**  
Install catch rollers with safety covers on the side of a post or wall with a minimal distance of half an inch between the rollers and gate

**DO NOT** use a gate catch post. Because the coasting distance may vary due to changes in temperature, it is **NOT** recommended to install a catch post in front of the gate's path. To do so will cause the gate to hit the post in certain instances.

## Additional Accessories

The vehicle loops allow the gate to stay open when vehicles are obstructing the gate path. Suggested for vehicles 14 feet (4.27 m) or longer. Vehicle loops are not required but are recommended. Before installing your Access Control Device(s) be sure to complete a site survey and determine the best device for your site needs.

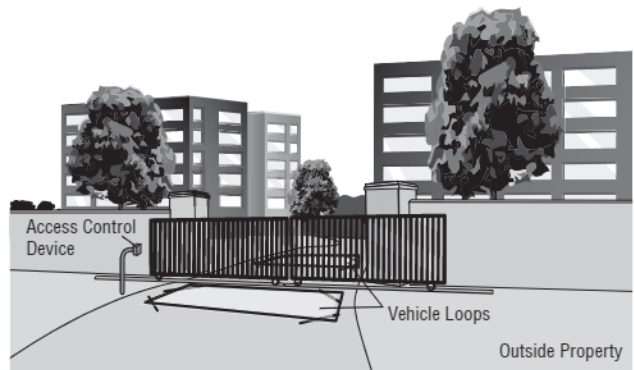



# INSTALLATION

## ⚠ CAUTION

- To AVOID damaging gas, power or other underground utility lines, contact underground utility locating companies BEFORE digging more than 18 inches (46 cm) deep.
- To prevent damage to the operator or gate, DO NOT drive the limit (nuts) actuators on the shaft past their normal positions.

### Step 1 Install the Operator

Check the national and local building codes before installation.

#### Install With Adjustable Rails

1. Locate and anchor two posts made of 3" (7.6 cm) outer diameter heavy walled pipe. Posts should be parallel and square to the gate.
2. Locate electrical conduit, as required, prior to pouring concrete.
3. Slide the four 3" (7.6 cm) clamps (provided) into the rails on the sides of the operator.
4. Slide the posts into the clamps and tighten the screws on the clamps to secure the operator.

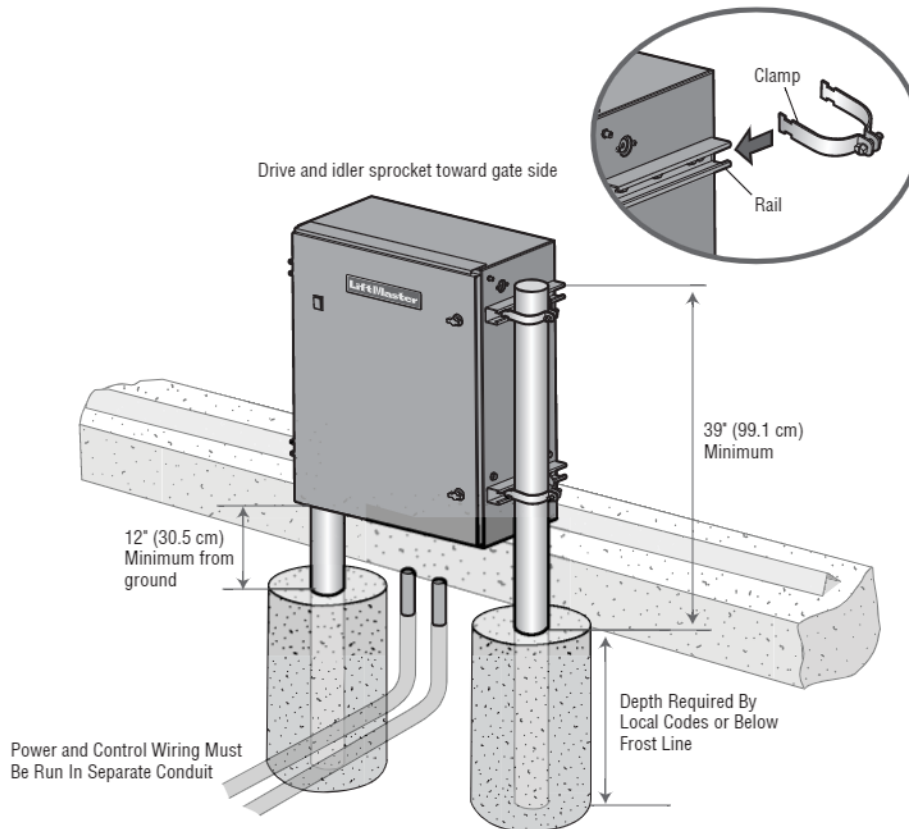
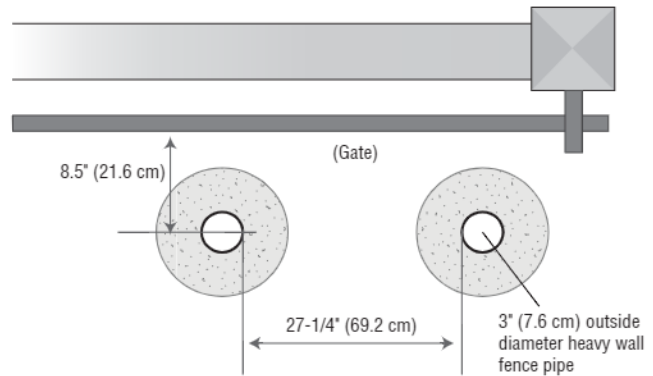

# INSTALLATION

## Install Without Adjustable Rails

Check the national and local building codes before installation.

**NOTE:** The rails will have to be removed for retro-fit installations.

1. Locate and anchor two posts made of 3" (7.6 cm) outer diameter heavy walled pipe. Posts should be parallel and square to the gate.
2. Locate electrical conduit, as required, prior to pouring concrete.
3. Remove the rails from the sides of the operator.
4. Secure Operator to posts using four 3" (7.6cm) U-bolts and hardware. The backing plate and gasket within the cabinet must be utilized with the U-bolts.
5. Fill any empty holes on the side of the operator with the extra bolts from the rails or apply a sealant.

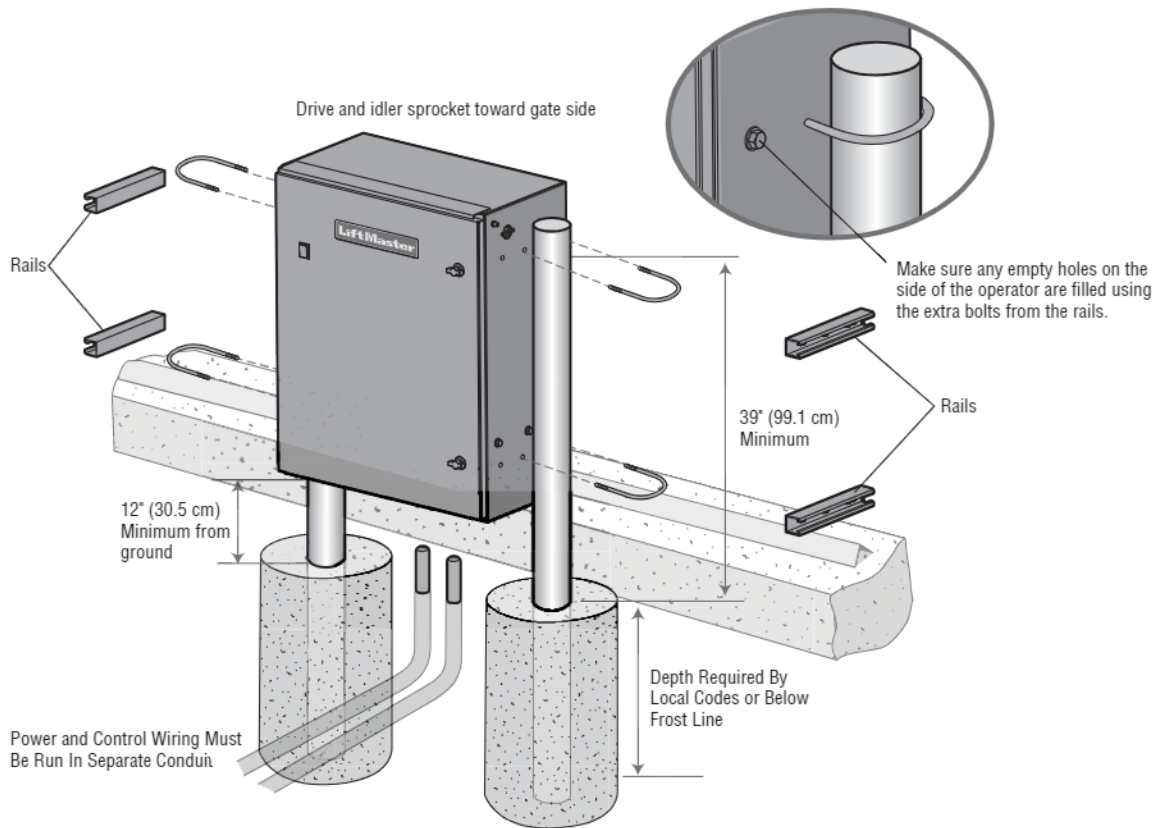
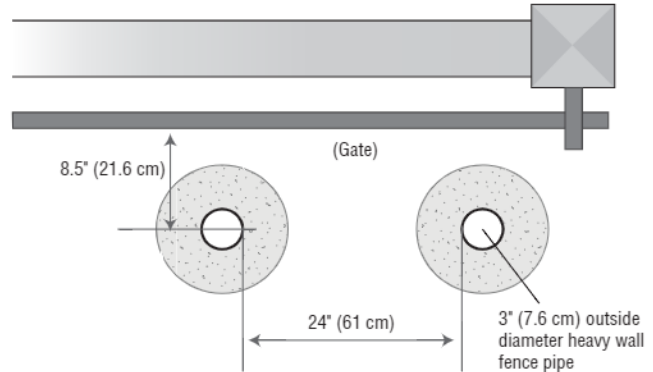

# INSTALLATION

## Step 2 Attach the Chain

**DO NOT** run the operator until instructed.

1. Mount gate brackets to the vertical front and rear posts of the gate.
2. Open operator door.
3. Locate the black T-shaped manual release handle attached to the gearbox in the bottom of the cabinet. Pull firmly until it latches into place.
4. Ensure that the drive and idler sprockets are in line with each other. Thread the chain through the plastic chain guide, around drive and idler sprockets, and then through the second plastic chain guide toward front gate bracket.
5. Adjust the chain to proper length and connect the chain to the front bracket with the provided hardware. Adjust nuts on chain take-up bolts to remove chain slack. A general rule of thumb is to leave a maximum of 1" (2.5 cm) of chain slack for every 10' (3.1 m) of chain length. **Do not overtighten chain.** **NOTE:** The operator can be moved forward or back along the rails to ensure the chain is aligned correctly with the operator.
6. Remove the pin from the vent plug on the gear box.
7. Push the plate down to release the manual release handle to re-engage the motor and gear box.

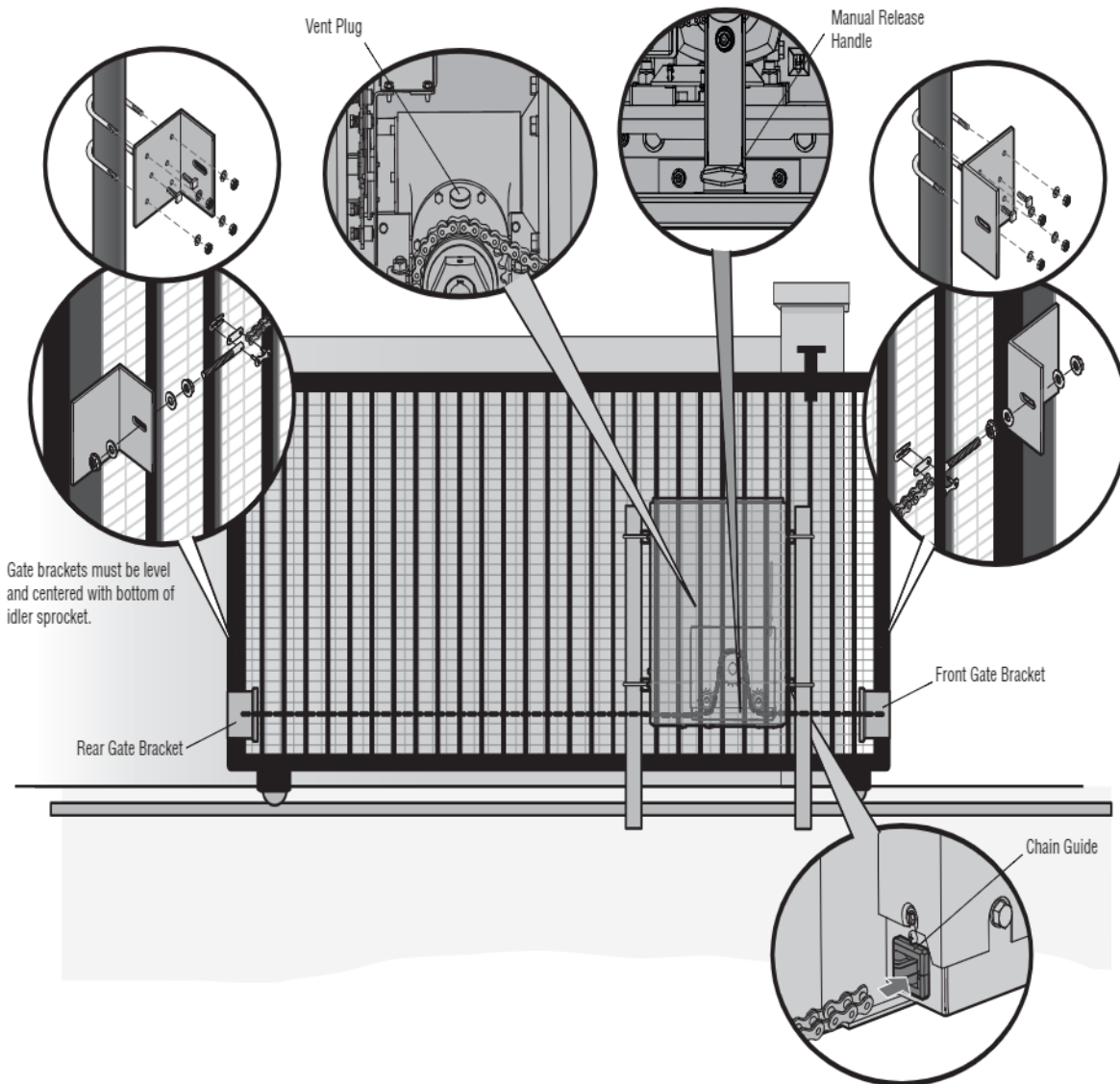

# INSTALLATION

## WARNING

To prevent SERIOUS INJURY or DEATH from a moving gate:

- ALL gate operator systems REQUIRE two independent entrapment protection systems for each entrapment zone.
- Entrapment protection devices MUST be installed to protect anyone who may come near a moving gate.
- Entrapment protection devices MUST be located to protect in BOTH the open and close gate cycles.
- Locate entrapment protection devices to protect between moving gate and RIGID objects, such as posts, walls, pillars, columns, or operator itself.

### Step 3 Install Entrapment Protection

#### Definitions

##### **ENTRAPMENT:**

The condition when a person is caught or held in a position that increases the risk of injury.

##### **SLIDE GATE ENTRAPMENT ZONE:**

An entrapment zone exists if at any point during travel, the gap between the gate and any opposing fixed edge or surface such as posts, walls, pillars, columns or operator itself, is less than 16" (406 mm) in a location up to 6 ft. (1.8 m) above grade.

# INSTALLATION

Install entrapment protection devices according to the *UL 325 Entrapment Protection Requirements* section, see page 3. Use the *Site Planning Safety Checklist* in the appendix, to identify entrapment zones that will result from the installation. See *Accessories* for approved entrapment protection devices.

## Requirements

1. Install entrapment protection devices for ALL entrapment zones.  
This operator has an inherent entrapment protection device built-in.  
The installer **MUST** provide one additional entrapment protection device for each entrapment zone.
2. The operator will **NOT** run unless a **minimum of two** external devices are connected; one in the open direction and one in the closed direction.
3. Test ALL entrapment protection devices **AFTER** installing the operator, refer to the manual provided with your entrapment protection device. Test the inherent entrapment protection by following the *Obstruction Test* instructions page 23.

See *Wire Entrapment Protection Devices* page 14.

*Illustration is for example only; your site may have additional entrapment zones which MUST be protected.*

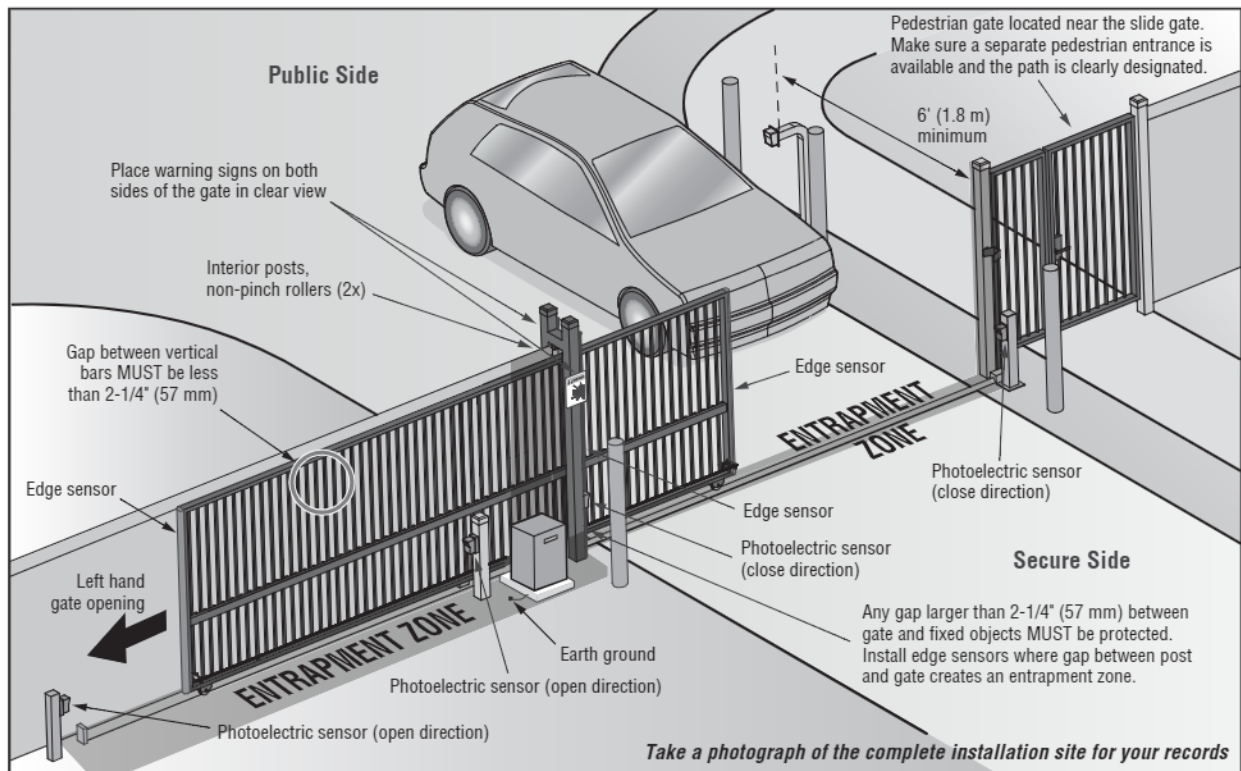

Illustrations provided by DASMA Gate Systems Safety Guide

# INSTALLATION

## Wire Entrapment Protection Devices

There are three options for wiring external entrapment protection devices depending on the specific device and how the device will function. Refer to the manual included with your entrapment protection device for more information. These entrapment protection device inputs are for monitored devices, which include pulsed photoelectric sensors, resistive edge sensors, and pulsed edge sensors. **Only one monitored entrapment protection device may be wired to each input.** Additional monitored entrapment protection devices may be wired to the expansion board.

**NOTE:** Board inputs for entrapment protection devices are yellow.

## Control Board

### CLOSE EYES/INTERRUPT

(2 Terminals) The CLOSE EYES/INTERRUPT input is for photoelectric sensor entrapment protection for the close direction. When an obstruction is sensed during gate closing the gate will open to the full open position and resets the Timer-to-Close. This input will be disregarded during gate opening.

### CLOSE EDGE

(2 Terminals) The CLOSE EDGE input is for edge sensor entrapment protection for the close direction. When an obstruction is sensed during gate closing the gate will reverse to the full open position, disengaging the Timer-to-Close. This input will be disregarded during gate opening.

### OPEN EYES/EDGE

(2 Terminals) The OPEN EYES/EDGE input is for photoelectric sensor or edge sensor entrapment protection for the open direction. When an obstruction is sensed during gate opening the gate will reverse for 4 seconds then stop. This input will be disregarded during gate closing.

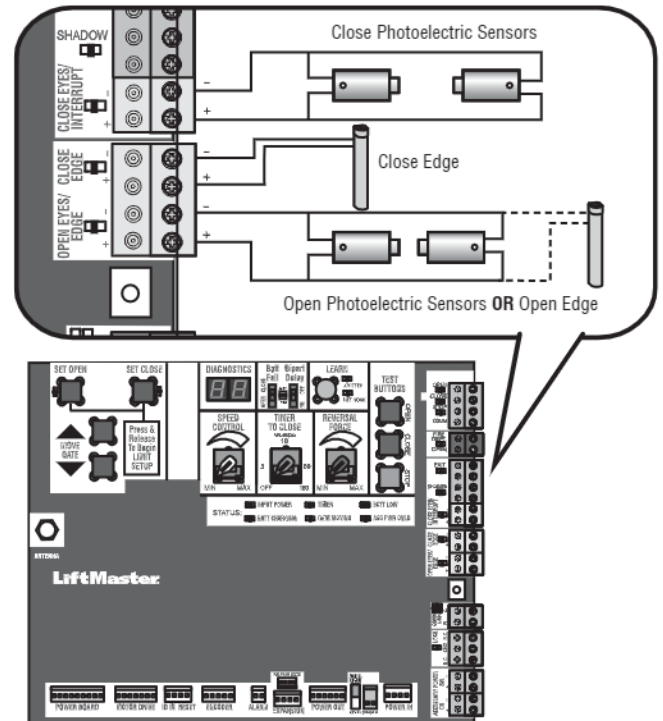

## Expansion Board

### EYE ONLY and COM

Open or Close Direction Photoelectric Sensors, the functionality is based on the switch settings (located next to the terminals)

**Switch set to CLOSE:** gate reverses fully when an obstruction is sensed

**Switch set to OPEN:** gate reverses 4 seconds when an obstruction is sensed

### EYE/EDGE and COM

Open or Close Direction Photoelectric Sensors or Edge Sensor, the functionality is based on the switch settings (located next to the terminals)

**Switch set to CLOSE:** gate reverses fully when an obstruction is sensed

**Switch set to OPEN:** gate reverses 4 seconds when an obstruction is sensed

### WIRELESS EDGE

Connection for wireless edge receiver. **NOTE: ONLY one wireless edge receiver may be connected to an operator. Up to 4 wireless edge transmitters LMWETXU may be programmed to the receiver.**

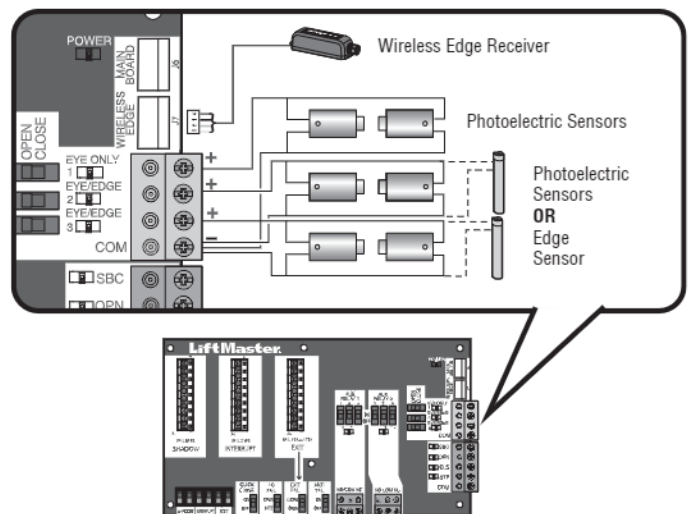

# INSTALLATION

## Step 4 Earth Ground Rod

Use the proper earth ground rod for your local area. The ground wire must be a single, whole piece of wire. Never splice two wires for the ground wire. If you should cut the ground wire too short, break it, or destroy its integrity, replace it with a single wire length.

**NOTE:** If the operator is not grounded properly the range of the remote controls will be reduced and the operator will be more susceptible to lightning and surge damage.

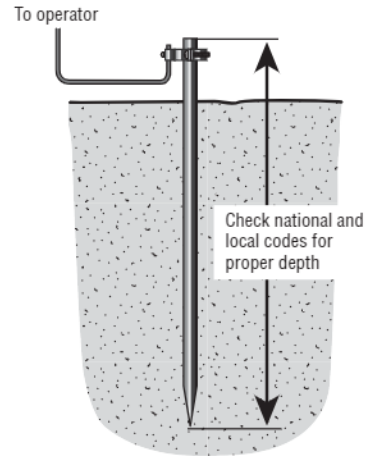

## Step 5 Power Wiring

### **WARNING**

To reduce the risk of SEVERE INJURY or DEATH:

- ANY maintenance to the operator or in the area near the operator MUST NOT be performed until disconnecting the electrical power (AC or solar and battery) and locking-out the power via the operator power switch. Upon completion of maintenance the area MUST be cleared and secured, at that time the unit may be returned to service.
- Disconnect power at the fuse box BEFORE proceeding. Operator MUST be properly grounded and connected in accordance with national and local electrical codes. **NOTE:** The operator should be on a separate fused line of adequate capacity.
- ALL electrical connections MUST be made by a qualified individual.
- DO NOT install ANY wiring or attempt to run the operator without consulting the wiring diagram.
- ALL power wiring should be on a dedicated circuit and well protected. The location of the power disconnect should be visible and clearly labeled.
- ALL power and control wiring MUST be run in separate conduit.

The operator can be wired for either 120 Vac or 240 Vac or a solar panel (not provided). Follow the directions according to your application. An optional Transformer Kit (Model 3PHCONV) can be used to change the input voltage (208/240/480/575 Vac) to an output voltage of 120 Vac (refer to Accessories). For dual gate applications, power will have to be connected to each operator. Main power supply and control wiring MUST be run in separate conduits.

**NOTE:** If using an external receiver use shielded wire for the connections and mount the receiver away from the operator to avoid interference from the operator.

INSL24UL MAXIMUM WIRE LENGTH

AMERICAN WIRE GAUGE (AWG)	STANDARD OPERATOR			OPERATOR + ACCESSORIES POWERED BY TRANSFORMER KIT accessory power outlets rated at 1 amp when the 3PHCONV kit is used			
	120 VAC, 9.3A (includes fully loaded outlets)	120 VAC, 3.3 A	240 VAC, 1.8 A	208 VAC, 2.8 A	240 VAC, 2.4 A	480 VAC, 1.2 A	575 VAC, 1 A
14	105	300	1,100	615	830	3,300	4,800
12	170	480	1,700	980	1,300	5,300	8,600
10	270	760	2,800	1,500	2,100	8,400	12,000
8	430	1,200	4,400	2,400	3,300	13,000	19,000
6	680	1,900	7,000	3,900	5,300	21,000	30,000
4	1,000	3,000	11,000	6,200	8,400	34,000	48,000

Chart assumes: copper wire, 65°C, 5% drop

# INSTALLATION

IHSL24UL MAXIMUM WIRE LENGTH							
AMERICAN WIRE GAUGE (AWG)	STANDARD OPERATOR			3PHCONV kit powering operator + heater + 1 Amp on outlets			
	120 VAC, 13 A (includes fully loaded outlets)	120 VAC, 7 A	240 VAC, 3.5 A	208 VAC, 5.2 A	240 VAC, 4.5 A	480 VAC, 2.3A	575 VAC, 1.9 A
14	75	140	600	330	440	1,700	2,500
12	120	225	900	525	700	2,700	4,000
10	200	360	1,440	840	1,100	4,400	6,300
8	300	600	2,300	1,300	1,800	6,900	10,000
6	500	900	3,600	2,100	2,800	11,000	16,000
4	800	1,400	5,800	3,400	4,500	17,000	25,000

*Chart assumes: copper wire, 65°C, 5% drop*

All control wiring used to connect external devices to Class 2 circuits of the operator must be (QPTZ) Power-Limited Circuit Cables, Type CL2, CL2P, CL2R, or CL2X or other cable with equivalent or better electrical, mechanical, and flammability ratings.

1. Turn off the AC power from the main power source circuit breaker.
2. Run the AC power wires to the operator.
3. Make sure the operator AC switch is in the OFF position, see page 16.
4. Remove the junction box cover from the electrical box by loosening the screws and sliding the cover to the side.
5. **120 Vac:** Factory default is 120 Vac. Skip to 6.  
**240 Vac:** Unplug the power wiring connector from the 120 Vac socket (factory default location) and plug it into the 240 Vac socket.  
**NOTE:** The accessory outlets are disabled and cannot be used with the 240 Vac option.
6. Connect the incoming green wire to the earth ground nut.
7. Connect the white wire to NEUTRAL using a wire nut.
8. Connect the black wire to HOT using a wire nut.
9. Replace the junction box cover. Ensure the wires are not pinched.

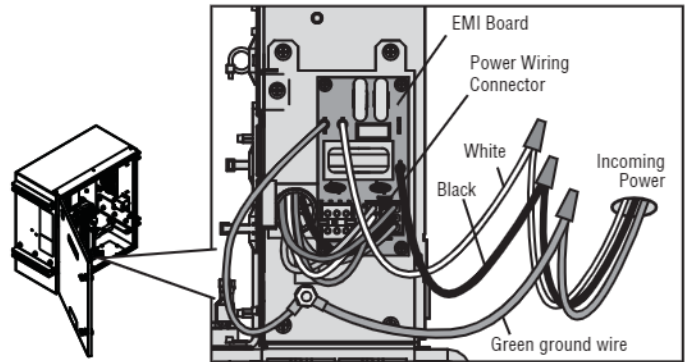

## AC Power Switch

The AC switch on the operator turns the incoming 120/240 Vac power ON or OFF. The AC switch ONLY turns off AC power to the control board and DOES NOT turn off battery power.

## Battery Switch

The battery switch turns the battery power on or off.

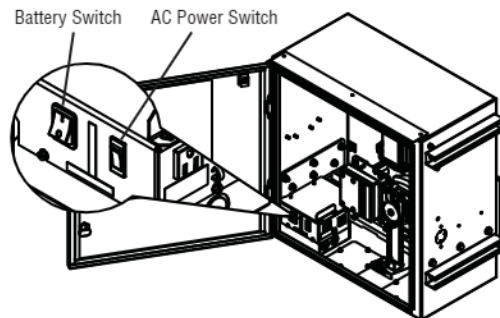



# INSTALLATION

## Step 6 Connect Batteries

### 7AH Batteries

The batteries are charged in the circuit by the integrated transformer.

1. Turn the AC power switch to OFF.
2. Turn the battery switch OFF .
3. Connect a jumper between the positive(+) terminal of the battery to the negative terminal(-) of the other battery.
4. Connect the red battery wire from the operator to the positive(+) terminal of the battery.
5. Connect the black battery wire from the operator to the negative (-) terminal of the battery.
6. Turn the battery switch ON .
7. Turn the AC power switch to ON to restore AC power.

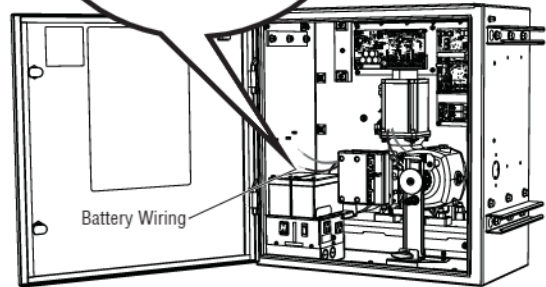
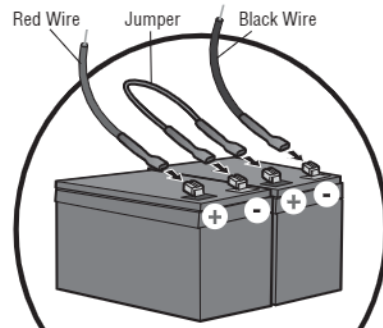

### 33AH Batteries

The batteries are charged in the circuit by the integrated transformer.  
The 33AH application requires battery harness K41-0102-000, see *Accessories*.

1. Turn the AC power switch to OFF.
2. Turn the battery switch OFF.
3. Connect a jumper between the positive(+) terminal of the battery to the negative terminal(-) of the other battery.
4. Connect the (+) terminal of the battery to the red battery wire from the operator using the RED harness kit wire .
5. Connect the (-) terminal of the battery to the black battery wire from the operator using the BLACK harness kit wire.
6. Turn the battery switch ON .
7. Turn the AC power switch to ON to restore AC power.

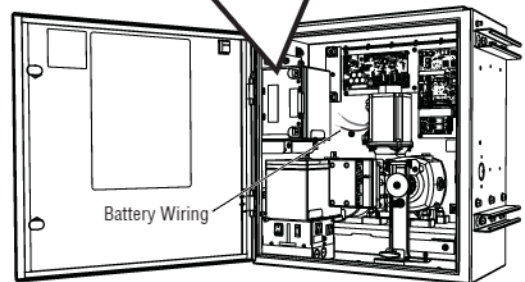
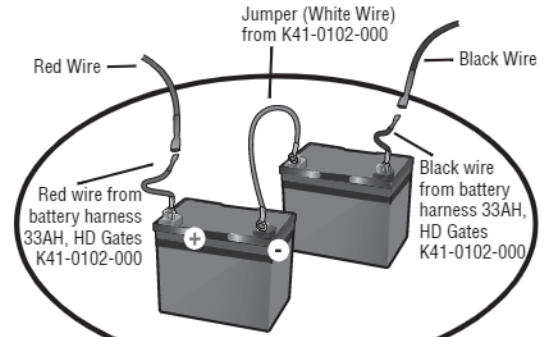

# INSTALLATION

## Step 7 Dual gate setup-Wireless

There are two options for dual gate communication: wired or wireless. Follow the directions according to your application. Do not use wired and wireless communication simultaneously. Use only the same operator models in a dual gate setup. Wired dual gate applications will have a longer battery standby time than wireless applications.

### Wireless setup

#### To activate the wireless feature:

1. Choose an operator to be the network primary operator. Program all wireless accessories to the primary operator except for any wireless entrapment protection devices required for the second operator. **NOTE:** We recommend that all accessories, except entrapment protection devices, and board configurations are set on the primary operator.
2. Press and release the LEARN button on the primary operator. The green XMITTER LED will light. **NOTE:** The operator will time out of programming mode after 180 seconds.
3. Press and release the LEARN button again on the primary operator. The yellow NETWORK LED will light.
4. Press and release the OPEN test button to assign this operator as network primary.
5. Press and release the LEARN button on the second operator. The green XMITTER LED will light.
6. Press and release the LEARN button again on the second operator. The yellow NETWORK LED will light.
7. Press and release the CLOSE test button to assign this operator as network second.

Both operators will beep and the yellow NETWORK LEDs will turn off indicating programming is successful.

#### To deactivate the wireless feature:

1. Press and release the LEARN button on either operator. The green XMITTER LED will light.
2. Press and release the LEARN button again on the same operator. The yellow NETWORK LED will light.
3. Press and hold the LEARN button for 5 seconds. The yellow NETWORK LED will blink (operator will beep) then turn off indicating successful deactivation.
4. Press and release SET OPEN and SET CLOSE buttons simultaneously. The yellow SET OPEN and SET CLOSE LEDs will light.
5. Press and release SET OPEN and SET CLOSE buttons simultaneously again. Both yellow LEDs will turn off and entrapment protection devices will be released.
6. Repeat the steps for the other operator.

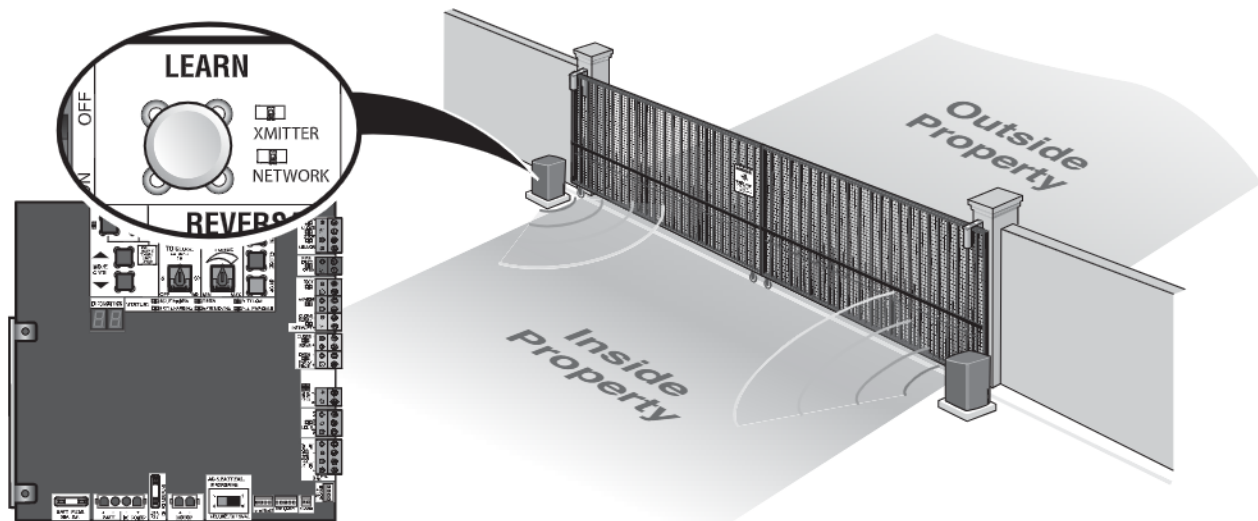

# INSTALLATION

## Wired setup

Use only the same operator models in a dual gate setup. Before digging, contact local underground utility locating companies. Use PVC conduit to prevent damage to cables.

1. Disconnect ALL power to the operator and turn OFF the battery and AC power switches.
2. Trench across driveway to bury the shielded twisted pair cable.
3. Connect the wires from the shielded twisted pair cable to the Com Link terminals on the primary gate operator control board. **NOTE:** We recommend that all accessories and board configurations are set on the primary operator.
4. Route the shielded twisted pair cable to the secondary gate operator's control board.
5. Connect the wires from the shielded twisted pair cable to the Com Link terminals on the secondary control board (Com Link A to Com Link A and Com Link B to Com Link B). Ground the shield of the cable to the chassis ground of one operator.
6. Connect ALL power to the operator and turn ON the battery and AC power switches.

DUAL GATE WIRE TYPE (SHIELDED TWISTED PAIR CABLE)	
22AWG up to 200 feet (61 m)	18AWG - 200-1000 feet (61-305 m)
Wire must be rated at 30 Volt minimum	

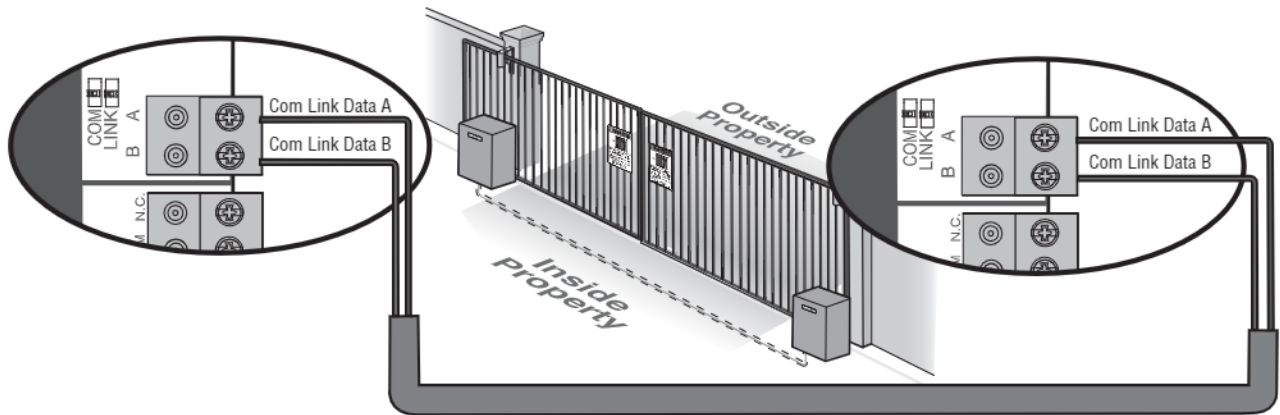

## Bipart delay/synchronized close

The BIPART DELAY switch is used only with dual gate applications and serves two functions:

- **BIPART DELAY**

*Not applicable for slide gate applications.*

- **SYNCHRONIZED CLOSE**

To synchronize the closing of the gates, set the BIPART DELAY switch to ON for both operators.

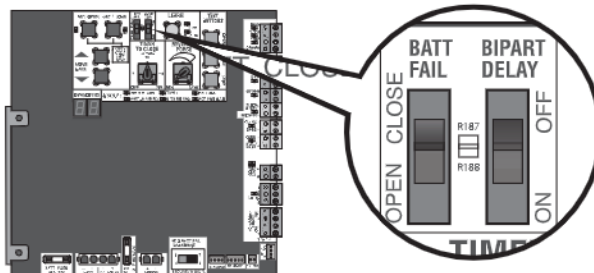

# INSTALLATION

## Step 8 Close and Secure the Door

*Before securing the door, follow the instructions in the Adjustment section to adjust the limits, speed, and force.*

1. Close the door.
2. Turn both latches 90 degrees.

## Step 9 Install Warning Signs

Installers **MUST** install the UL required warning signs. The signs **MUST** be installed in plain view on **both sides** of each gate installed. Use the fastening holes in each corner to permanently secure the sign.



The basic installation is complete.

# ADJUSTMENT

## Limit, Speed, and Force Adjustment

### ! WARNING

To reduce the risk of SEVERE INJURY or DEATH:

- Without a properly installed safety reversal system, persons (particularly small children) could be SERIOUSLY INJURED or KILLED by a moving gate.
- Too much force on gate will interfere with proper operation of safety reversal system.
- NEVER increase force beyond minimum amount required to move gate.
- NEVER use force adjustments to compensate for a binding or sticking gate.
- If one control (force, speed or travel limits) is adjusted, the other controls may also need adjustment.
- After ANY adjustments are made, the safety reversal system MUST be tested. Gate MUST reverse on contact with an object.
- Faster gate speed increases risk to pedestrians. Use minimum speed necessary to move gate.

### Introduction

Your operator is designed with electronic controls to make travel limit and force adjustments easy. The adjustments allow you to program where the gate will stop in the open and close position. The electronic controls sense the amount of force required to open and close the gate. The force is adjusted automatically when you program the limits but should be fine tuned using the REVERSAL FORCE dial on the control board (refer to Fine Tune the Force section) to compensate for environmental changes. The limit setup LEDs (located next to the SET OPEN and SET CLOSE buttons) indicate the status of the limits, refer to the table to the right.

The limits can be set using the control board (below) or a remote control (refer to Limit Setup with a Remote Control in the Appendix). Setting the limits with a remote control requires a 3-button remote control programmed to OPEN, CLOSE, and STOP.

**NOTE:** The TEST buttons on the control board will not work until the limits have been set and the required entrapment protection devices are installed.

### Set the Initial Limits, Speed, and Force

For dual gate applications the limits will have to be set for each operator. The gate MUST be attached to the operator before setting the limits and force.

For slide gate applications the open limit and closed limit MUST be set at least four feet apart.

1. Press and release the SET OPEN and SET CLOSE buttons simultaneously to enter limit setting mode.
2. Press and hold one of the MOVE GATE buttons to move the gate to the open or close limit.
3. Press and release the SET CLOSE or SET OPEN button depending on which limit is being set.
4. Press and hold one of the MOVE GATE button to move the gate to the other limit.
5. Press and release the SET CLOSE or SET OPEN button depending on which limit is being set.
6. Set the speed dial to the desired setting, see page 22. 0.5 ft/sec. min - 1 ft./sec. max.
7. Cycle the gate open and close. This automatically sets the force.

When limits are set properly the operator will automatically exit limit setting mode.

SET OPEN LED	SET CLOSE LED	OPERATOR MODE	EXPLANATION
OFF	OFF	NORMAL MODE	Limits are set
BLINKING	BLINKING	LIMIT SETTING MODE	Limits are not set
BLINKING	ON	LIMIT SETTING MODE	Open limit is not set
ON	BLINKING	LIMIT SETTING MODE	Close limit is not set
ON	ON	LIMIT SETTING MODE	Limits are set

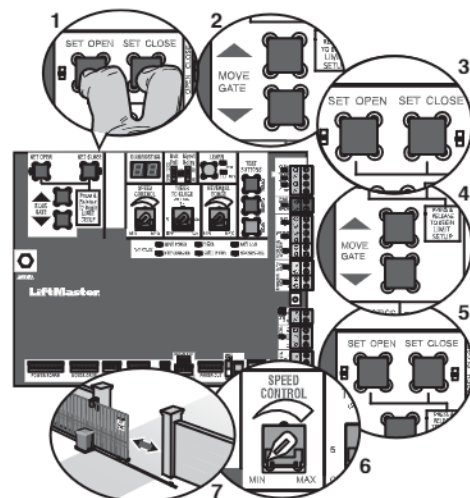

# ADJUSTMENT

## Speed Control

The SPEED CONTROL dial controls the speed of the operator. The dial is preset to minimum from the factory. Set the speed as low as possible for the intended application.

Gate operating speed: 0.5 ft./sec. - 1 ft./sec.

For dual gate setup, set the SPEED CONTROL dial on each operator to the same setting or make sure the gate that travels further is set faster than the other operator for the smoothest operation.

After any speed adjustment:

1. Cycle the gate open and close to automatically relearn the forces.
2. Perform the Obstruction Test, see page 23.

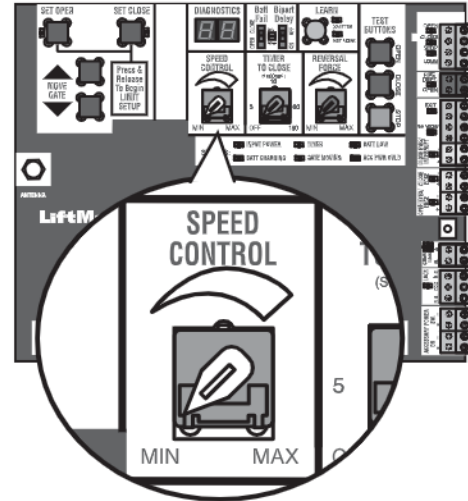

## Fine Tune the Force

Once the initial limits have been set, the REVERSAL FORCE DIAL on the control board is used for fine tuning the force where wind or environmental changes may affect the gate travel. The REVERSAL FORCE DIAL is set to minimum at the factory.

Based on the length and weight of the gate it may be necessary to make additional force adjustments. The force setting should be high enough that the gate will not reverse by itself nor cause nuisance interruptions, but low enough to prevent serious injury to a person. The force setting is the same for both the open and close gate directions.

1. Open and close the gate with the TEST BUTTONS.
2. If the gate stops or reverses before reaching the fully open or closed position, increase the force by turning the force control slightly clockwise.
3. Perform the "Obstruction Test" after every limit, speed, and force setting adjustment see page 23.

**Settings 1-3:** Fixed force settings (gate will not adjust due to gate wear or temperature changes).

**Settings 4-10:** Automatically increase the force due to gate wear or temperature changes.

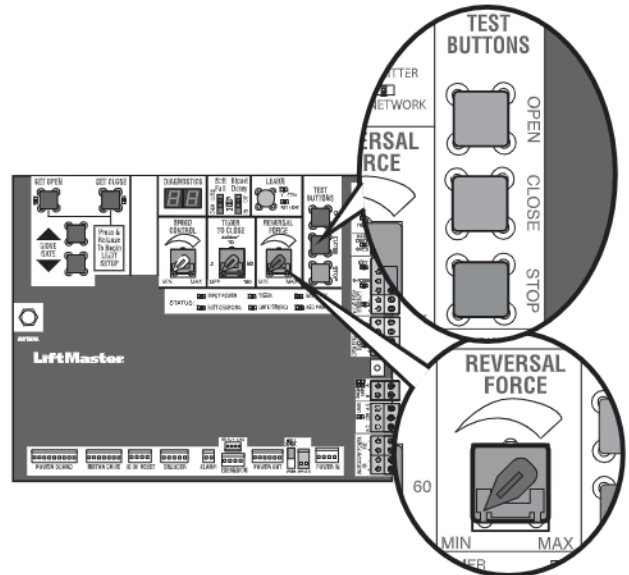

# ADJUSTMENT

## Adjust the Limits

After both limits are set and the operator is ready to run, one limit can be adjusted independently from the other by following steps 1-3 of the Initial Limit and Force Adjustment section.

### After any limit adjustment:

1. Cycle the gate open and close to automatically relearn the forces.
2. Perform the Obstruction Test, see page 23.

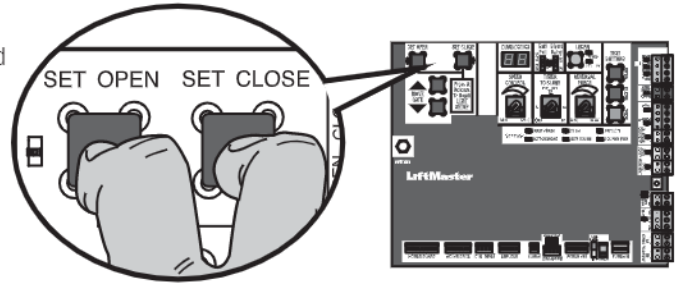

## Obstruction Test

The operator is equipped with an inherent (built in to the operator) obstruction sensing device. If the gate encounters an obstruction during motion, the operator will reverse direction of the gate and then stop. The following procedure will test ONLY the inherent (built in to the operator) obstruction sensing device:

1. Open and close the gate with the TEST BUTTONS, ensuring that the gate is stopping at the proper open and close limit positions.
2. Either place an object between the open gate and the fixed closed catch post **or** obstruct the gate by hand. Make sure that any external entrapment protection devices, such as an edge or photoelectric sensor will NOT be activated by the object or by hand.
3. Run the gate in the close direction. The gate should stop and reverse upon contact with the object or hand. If the gate does not reverse, reduce the force setting by turning the force control slightly counter-clockwise. The gate should have enough force to reach both the open and close limits, but MUST reverse after contact with an object or hand.
4. Repeat the test for the open direction.

**Test the operator after any adjustments are made.**

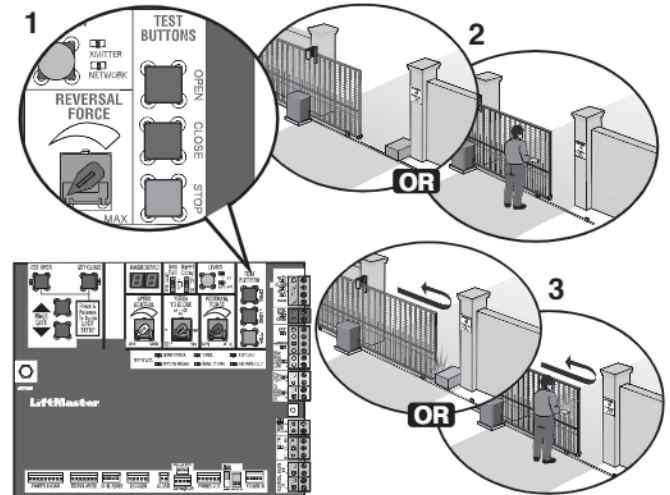

# PROGRAMMING

## Remote Controls (Not Provided)

A total of 50 Security+ 2.0® remote controls or KPW250 keypads and 2 keyless entries (1 PIN for each keyless entry) can be programmed to the operator. When programming a third keyless entry to the operator, the first keyless entry will be erased to allow the third keyless entry to be programmed. When the operator's memory is full it will exit the programming mode and the remote control will not be programmed. The memory will need to be erased before programming any additional remote controls. **NOTE:** If installing an 86LM to extend the range of the remote controls DO NOT straighten the antenna.

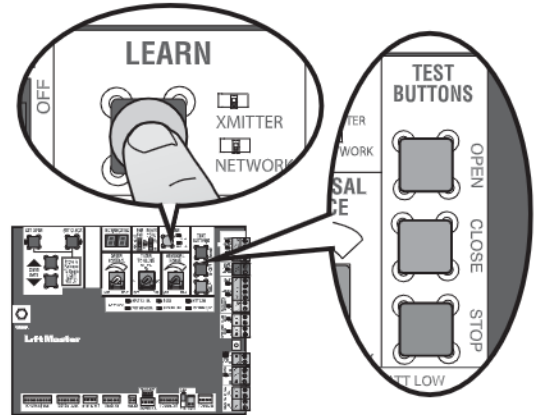

There are 3 different options for programming the remote control depending on how you would like the remote control to function. Choose a programming option:

OPTION	DESCRIPTION	PROGRAMMING STEPS
Single button as OPEN only	Program a single button on the remote control for open only. The Timer-to-Close can be set to close the gate.	<ol style="list-style-type: none"> <li>1. Press and release the LEARN button (operator will beep and green XMITTER LED will light). <b>NOTE:</b> The operator will time out of programming mode after 30 seconds.</li> <li>2. Press the OPEN button.</li> <li>3. Press the remote control button that you would like to program.</li> </ol>
Single button (SBC) as OPEN, CLOSE, and STOP	Program one remote control button as an open, close, and stop.	<ol style="list-style-type: none"> <li>1. Press and release the LEARN button (operator will beep and green XMITTER LED will light). <b>NOTE:</b> The operator will time out of programming mode after 30 seconds.</li> <li>2. Press the remote control button that you would like to program.</li> </ol>
Three separate buttons as OPEN, CLOSE, and STOP	Program each remote control button as an open, close, and stop.	<ol style="list-style-type: none"> <li>1. Press and release the LEARN button (operator will beep and green XMITTER LED will light). <b>NOTE:</b> The operator will time out of programming mode after 30 seconds.</li> <li>2. Press the OPEN, CLOSE, or STOP button, depending on the desired function.</li> <li>3. Press the remote control button that you would like to program.</li> </ol>

The operator will automatically exit learn mode (operator will beep and green XMITTER LED will go out) if programming is successful. To program additional Security+ 2.0® remote controls or remote control buttons, repeat the programming steps above.

### Entering programming mode using external reset button or 3-button control station:

1. Make sure gate/door is closed.
2. Give the operator an OPEN command.
3. To put the operator into high band programming mode, give the operator an OPEN command. Within 30 seconds, when the gate is at the open limit, press the reset button three times or push the button on the control station three times. **NOTE:** The operator will time out of programming mode after 30 seconds.

NOTICE: This device complies with Part 15 of the FCC rules and Industry Canada's license-exempt RSSs. Operation is subject to the following two conditions: (1) this device may not cause harmful interference, and (2) this device must accept any interference received, including interference that may cause undesired operation.

Any changes or modifications not expressly approved by the party responsible for compliance could void the user's authority to operate the equipment.

This device must be installed to ensure a minimum 20 cm (8 in.) distance is maintained between users/bystanders and device.

This device has been tested and found to comply with the limits for a Class B digital device, pursuant to part 15 of the FCC rules and Industry Canada ICES standard. These limits are designed to provide reasonable protection against harmful interference in a residential installation. This equipment generates, uses and can radiate radio frequency energy and, if not installed and used in accordance with the instructions, may cause harmful interference to radio communications. However, there is no guarantee that interference will not occur in a particular installation. If this equipment does cause harmful interference to radio or television reception, which can be determined by turning the equipment off and on, the user is encouraged to try to correct the interference by one or more of the following measures:

- Reorient or relocate the receiving antenna.
- Increase the separation between the equipment and receiver.
- Connect the equipment into an outlet on a circuit different from that to which the receiver is connected.
- Consult the dealer or an experienced radio/TV technician for help.



# PROGRAMMING

## LiftMaster Internet Gateway (not provided)

To program the operator to the LiftMaster Internet Gateway:

1. Connect the ethernet cable to the LiftMaster Internet Gateway and the router.
2. Connect power to the LiftMaster Internet Gateway.
3. Download the myQ® App.
4. Set up an account and follow the app instructions to add your gate operator.
5. The LiftMaster Internet Gateway will pair to the operator if it is within range and the operator will beep if programming is successful.

The gate operator can then be controlled through the myQ® App.

### To erase the gateway:

1. Press and release the LEARN button on either operator. The green XMITTER LED will light.
2. Press and release the LEARN button again on the same operator. The yellow NETWORK LED will light.
3. Press and hold the LEARN button for 5 seconds. The yellow NETWORK LED will blink (operator will beep) then turn off indicating devices have been successfully erased.

## CAPXLV Connected Access Portal

The CAPXLV can communicate wirelessly to LiftMaster® UL325 2016 gate operators to send open commands, monitor gate position, and send email notifications if an error occurs in the operator (email notifications are configured in myQ® Business™). Up to 8 gate operators can be paired with the CAPXLV - one for each primary and auxiliary relay. If using dual gates, program the CAPXLV to the primary operator.

### To Program the CAPXLV:

1. Enter Admin Mode - Flip dipswitch #1 to the ON position to enter Admin Mode. **NOTE:** For new installations press the login button without entering information in the Admin Username and Admin Password fields.

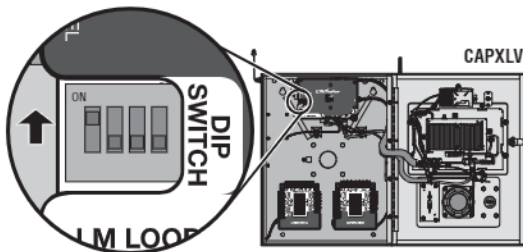

2. Select Outputs and Relay - Select the Outputs tab. Then select the desired relay on the left-hand side (1 through 4).

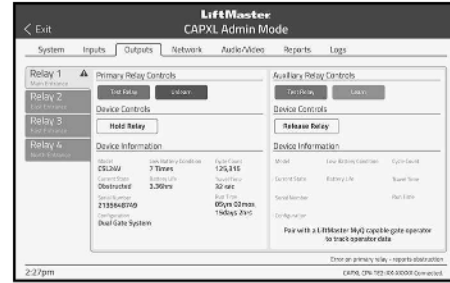

3. Press LEARN button on gate operator - Press and release the LEARN button on the primary operator. The green XMITTER LED will light. **NOTE:** The operator will time out of programming mode after 180 seconds.

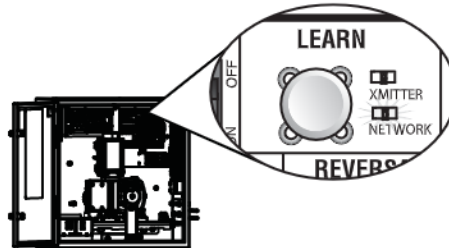

4. Press LEARN button on gate operator again - Press and release the LEARN button again on the primary operator. The yellow NETWORK LED will light.

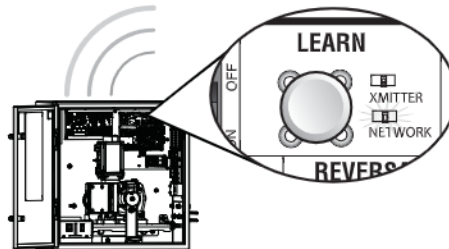

5. Select LEARN on display - Select the LEARN button on the display and the Learn button will go from blue to red. The gate operator and the CAPXLV will beep once and the NETWORK LED on the gate operator will turn off indicating programming is successful. **NOTE:** 4 beeps/blinks indicate you are not programming to the primary operator. Attempt programming from the other operator.

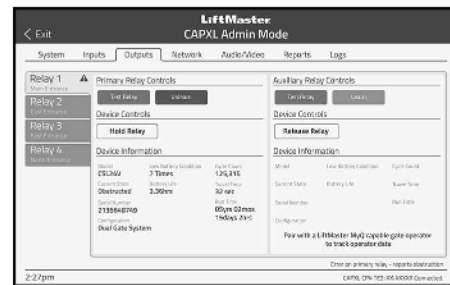

# PROGRAMMING

6. Validate - Validate functionality by selecting Test Relay on the CAPXLV display.



For more information refer to the CAPXLV documentation.

## myQ® Business™:

To find out more on how to simply secure all of your access points with an easy to manage integrated system, myQ Business, please visit: [www.myqbusiness.com](http://www.myqbusiness.com).

## Erase All Transmitter and Keypad Codes

1. Press and release the LEARN button (operator will beep and green XMITTER LED will light).
2. Press and hold the LEARN button again until the green XMITTER LED flashes and then release the button (approximately 6 seconds). All remote control codes are now erased.

## Erase Limits

1. To erase the limits, press and hold the SET OPEN and SET CLOSE buttons simultaneously (5 seconds) until both the SET OPEN and SET CLOSE LEDs blink rapidly and the operator beeps.
2. Release the buttons and the SET OPEN and SET CLOSE LEDs will blink slowly indicating the limits will need to be set.

## Constant Pressure Override (CPO)

Constant Pressure Override is for use with KPW5 and KPW250 keypads (not provided). The KPW5/KPW250 wireless commercial keypads are security keypads and can only be programmed to ONE gate operator (see the KPW5/KPW250 manual for complete programming instructions).

The Constant Pressure Override feature is intended to temporarily override a fault in the entrapment protection system, in order to operate the gate until the external entrapment protection device is realigned or repaired. Use the feature only in line of sight of the gate when no obstructions to travel are present. External entrapment protection devices include LiftMaster monitored photoelectric sensors and LiftMaster monitored wired and wireless edge sensors. Be sure to repair or replace these devices promptly if they are not working properly.

### To use Constant Pressure Override:

1. Enter a valid 4-digit PIN.
2. Press and hold # for 5 seconds to enter CPO. Continue to hold # to keep the operator in motion. A continuous tone will sound until limit is met and/or # is released.
3. The operator will stop when either the operator reaches a limit or the user releases #.

## Gate Hold Open Feature

The gate hold open feature will disable the timer and keep the gate at the open limit. The gate hold open feature can be activated with the reset button, see page 29 or on the KPW5 and KPW250 keypads (not provided).

### To use the gate hold open feature on a keypad:

1. Enter a valid 4-digit PIN when the gate is at the open limit and the timer is running
2. The operator will chirp indicating the timer is canceled.

### To restart the gate:

1. Re-enter the 4-digit PIN
2. Activate a hard input or a programmed remote

## To Remove and Erase Monitored Entrapment Protection Devices

1. Remove the entrapment protection device wires from the terminal block.
2. Press and release the SET OPEN and SET CLOSE buttons simultaneously. The SET OPEN and SET CLOSE LEDs will turn on (entering learn limit mode).
3. Press and release both SET OPEN and SET CLOSE buttons again to turn off the SET OPEN and SET CLOSE LEDs (exiting learn limit mode).

# OPERATION

## Gate Operator Setup Examples

The following are example setups for the gate operator. Your specific site requirements may be different. Always setup the operator system to the site requirements, including all necessary entrapment protection devices.

**COMMERCIAL/GENERAL ACCESS:** A residential community (more than four homes) having one or more gated entrances/exits, allowing vehicle access trumps security concerns

**COMMERCIAL:** Business site where security (gate closed) is important

**INDUSTRIAL:** Large business site where security is required

SETTING	COMMERCIAL/GENERAL ACCESS	COMMERCIAL	INDUSTRIAL
<b>Quick Close switch setting</b>	Normally set to OFF. Normal gate close (timer or control).	Normally set to OFF. Normal gate close (timer or control).	Set to ON, so that gate closes immediately after vehicle passes CLOSE EYES/Interrupt loop.
<b>AC Fail Open switch setting</b>	Normally set to BATT. For local jurisdiction requirement, set to OPEN so that the gate will open approximately 15 seconds after AC power fail.	Normally set to BATT. Run on battery if AC power fails.	Normally set to BATT. Run on battery if AC power fails.
<b>Low Battery switch setting</b>	Normally set to OPEN. If powered from battery and battery is low, gate automatically opens and stays open.	Normally set to CLOSE. If powered from battery and battery is low, gate stays closed.	Normally set to CLOSE. If powered from battery and battery is low, gate stays closed.
<b>Anti-Tail switch setting</b>	Normally set to OFF. CLOSE EYES/Interrupt loop reverses a closing gate.	Set to ON. In attempt to prevent vehicle tail-gating, CLOSE EYES/ Interrupt loop pauses a closing gate.	Set to ON. In attempt to prevent vehicle tail-gating, CLOSE EYES/ Interrupt loop pauses a closing gate.
<b>Bipart Delay switch setting</b>	For DUAL-GATE site, set to ON for gate that delays upon opening.	For DUAL-GATE site, set to ON for gate that delays upon opening.	For DUAL-GATE site, set to ON for gate that delays upon opening.
<b>Aux Relay Out – Open Limit Switch</b>	Use with SAMS (Sequence Access Management System).	1. Use with SAMS (Sequence Access Management System). 2. Connect “Gate Open” indicator (e.g. light).	1. Use with SAMS (Sequence Access Management System). 2. Connect “Gate Open” indicator (e.g. light).
<b>Aux Relay Out – Close Limit Switch</b>	Typically not required.	Connect “Gate Close/Secure” indicator (e.g. light).	Connect “Gate Close/Secure” indicator (e.g. light).
<b>Aux Relay Out – Gate Motion</b>	Attach alert signal (audible or visual alert system).	Attach alert signal (audible or visual alert system).	Attach alert signal (audible or visual alert system).
<b>Aux Relay Out – Pre-Motion Delay</b>	Attach alert signal (audible or visual alert system).	Attach alert signal (audible or visual alert system).	Attach alert signal (audible or visual alert system).
<b>Aux Relay Out – Power</b>	Attach visual alert to know when system is charging batteries (i.e. not running on batteries).	Attach visual alert to know when system is charging batteries (i.e. not running on batteries).	Attach visual alert to know when system is charging batteries (i.e. not running on batteries).
<b>Aux Relay Out – Tamper (Slide Gates Only)</b>	Attach alert signal (audible or visual alert system) to indicate if gate is manually tampered with by being pushed off of close limit.	Attach alert signal (audible or visual alert system) to indicate if gate is manually tampered with by being pushed off of close limit.	Attach alert signal (audible or visual alert system) to indicate if gate is manually tampered with by being pushed off of close limit.
<b>Cycle Quantity Feedback</b>	Use during servicing only to determine operator cycles.	Use during servicing only to determine operator cycles.	Use during servicing only to determine operator cycles.
<b>Fire Dept Open Input</b>	Connect emergency access system (Knox box switch, SOS system, etc.).	Typically not required.	Typically not required.

# OPERATOR OVERVIEW

## Control Board Overview

**1 SET OPEN Button:** The SET OPEN button sets the OPEN limit. See *Adjustment* section.

**2 SET CLOSE Button:** The SET CLOSE button sets the CLOSE limit. See *Adjustment* section.

**3 DIAGNOSTICS Display:** The diagnostics display will show the operator type, firmware version, and codes. The operator type will display as "IH" for heavy and "IN" for light, followed by a "24" which indicates the operator type as IHSL24UL/ INSL24UL. The firmware version will show after the operator type, example "1.2".

### 4 BATT FAIL:

- When AC power is OFF and battery voltage is critically low the gate will latch at a limit until AC power is restored or batteries voltage increases.
- Option select switch set to OPEN forces gate to automatically open and then latch at the OPEN limit until AC power is restored or battery voltage increases.
- Option select switch set to CLOSE forces gate to latch at CLOSE limit if at CLOSE limit or on next CLOSE command until AC power restored or battery voltage increases.
- Constant pressure on a hard command input overrides to open or close the gate.
- Critically low battery is less than 23 VDC.

**5 BIPART DELAY Switch:** The BIPART DELAY switch is used only for dual gates. See *Bipart delay/synchronized closed* page 19.

**6 LEARN Button:** The LEARN button is for programming remote controls and the network.

**7 TEST BUTTONS:** The TEST BUTTONS will operate the gate (OPEN, STOP and CLOSE).

**8 MOVE GATE Buttons:** The MOVE GATE buttons will either open or close the gate when the operator is in Limit setting mode. See *Adjustment* section.

**9 SPEED CONTROL dial:** Sets maximum gate speed. See *Speed Control* page 22.

**10 TIMER-TO-CLOSE dial:** The TIMER-TO-CLOSE (TTC) dial can be set to automatically close the gate after a specified time period. The TTC is factory set to OFF. If the TTC is set to the OFF position, then the gate will remain open until the operator receives another command from a control. Rotate the TIMER-TO-CLOSE dial to the desired setting. The range is 0 to 180 seconds, 0 seconds is OFF. **NOTE:** Any radio command, single button control, or CLOSE command on the control board prior to the TTC expiring will close the gate. The TTC is reset by any signals from the open controls, loops, close edges, and close photoelectric sensors (IR's).

**11 REVERSAL FORCE dial:** The REVERSAL FORCE dial fine tunes the force. See *Fine Tune the Force* page 22.

**12 STATUS LEDs:** The STATUS LEDs indicate the status of the operator. See Status LED Chart in the *Troubleshooting* section.

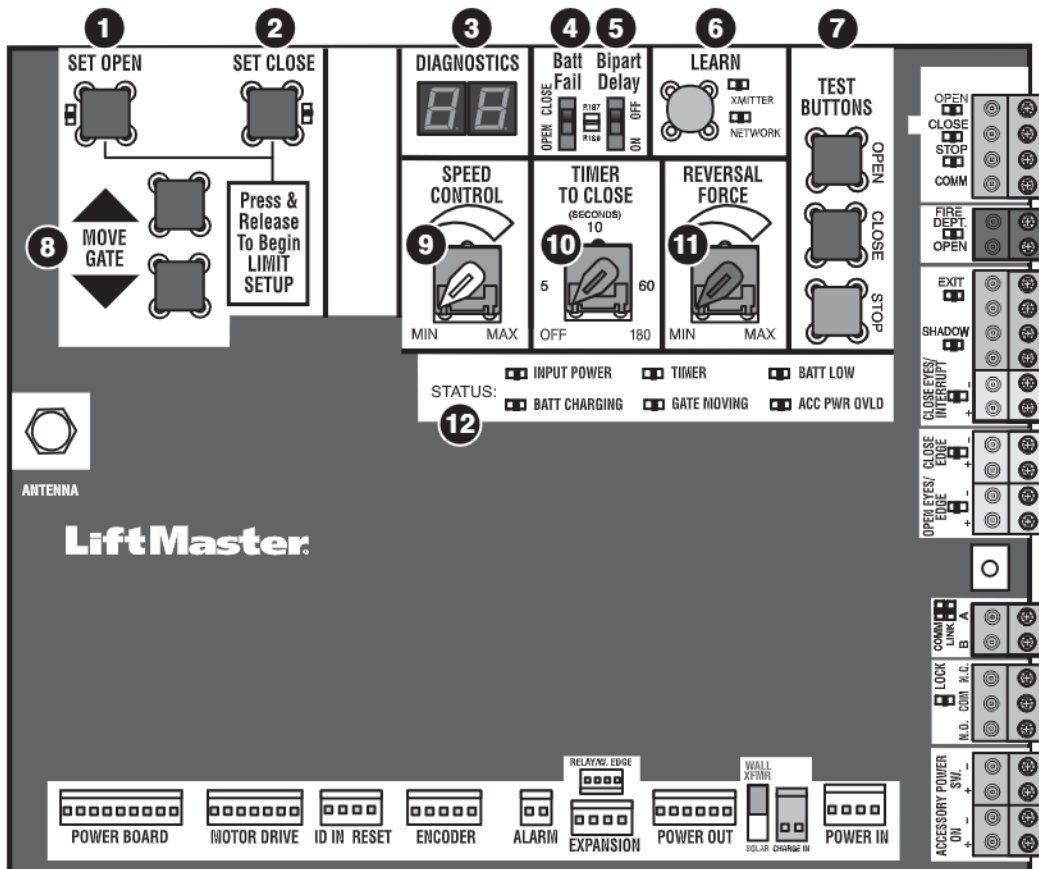

# OPERATOR OVERVIEW

## Manual Disconnect

1. Open the cabinet door.
2. Locate the black T-shaped manual release handle attached to the gearbox in the bottom of the cabinet.
3. Pull firmly until it latches into place.

To resume normal function, push the plate down to release the handle and re-engage the motor and the gearbox.

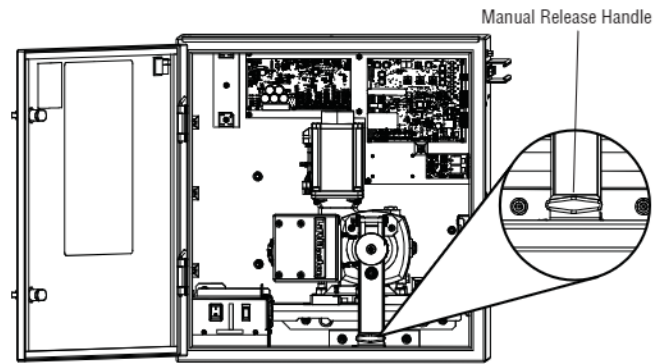

## Reset Button

The reset button has the following functions:

- Press the reset button to stop a moving gate during a normal open/close cycle, like a stop button.
- Press the reset button once while the gate is in open position to disable the Timer-to-Close. The gate will stay in the open position. To restart the Timer-to-Close either press the reset button or activate the gate with a programmed remote control.
- Press the reset button to shut off the alarm and reset the operator.

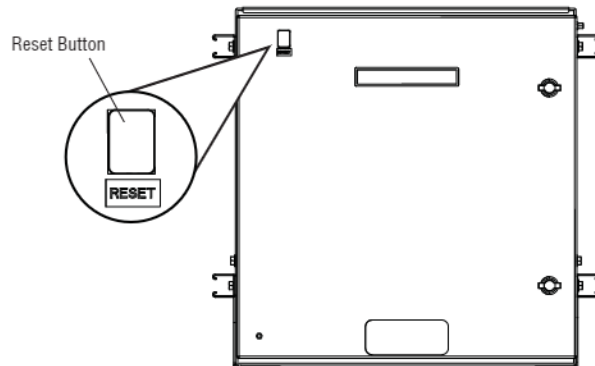

# OPERATION

## Operator Alarm

When the inherent force of the operator detects the following twice consecutively, the alarm will sound up to 5 minutes and the operator will need to be reset.

- A. The gate is hitting an obstruction.
- B. The gate does not meet specifications.
- C. Debris is on the gate's track such as mud, rocks, dirt, etc.
- D. The gate has one or more broken axles or wheels.
- E. The gate wheel is off the gate rail.

The operator alarm will beep 3 times with a command if the battery is low.

Remove any obstructions or repair gate system. Press the reset button to shut off the alarm and reset the operator. After the operator is reset, normal functions will resume.

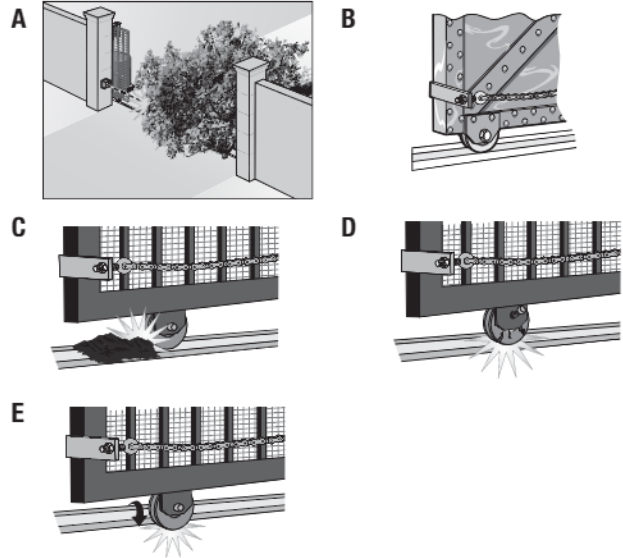

## Remote control

There are 3 different options for programming the remote control depending on how you would like the remote control to function, see page 24.

### Single Button Open Only

When gate is in the closed position, activation of the remote control button will open the gate. The Timer-to-Close can be set to close the gate.

### Single Button Control (SBC) Functionality

Program one remote control button as an open, close, and stop

When gate is in the closed position, activation of the remote control button will open the gate. During the open cycle another activation of the remote control will stop the gate and the next activation of the remote control will close the gate.

When the gate is in the open position, activation of the remote control button will close the gate. If the remote control is activated while the gate is closing, the gate will stop and the next activation will open the gate.

### Three Button Remote Control

Program each remote control button as an open, close, and stop.

# ACCESSORY WIRING

All control wiring used to connect external devices to Class 2 circuits of the operator must be (QPTZ) Power-Limited Circuit Cables, Type CL2, CL2P, CL2R, or CL2X or other cable with equivalent or better electrical, mechanical, and flammability ratings.

## External Control Devices

**NOT TO BE USED AS ENTRAPMENT PROTECTION**

### EXIT (2 Terminals)

This input is a soft open command (maintained switch does not override external safeties and does not reset alarm condition). Used for exit probe, telephone entry, external exit loop detector, or any device that would command the gate to open.

- Opens a closed or closing gate and holds open an open gate, if maintained, pauses Timer-to-Close at OPEN limit.

### SHADOW (2 Terminals)

This input is used for external shadow loop detector when loop is positioned under the swing of the gate.

- Holds open gate at open limit
- Only active when the gate is at the OPEN limit, disregarded at all other times
- Pauses Timer-to-Close at OPEN limit

### INTERRUPT (2 Terminals)

This input is used for an external interrupt loop detector when loop is on the outside of the gate.

- Holds open gate at open limit
- Stops and reverses a closing gate to open limit
- Pauses Timer-to-Close at OPEN limit, activates quick close and anti-tailgate features when enabled on the expansion board

Access control device wiring

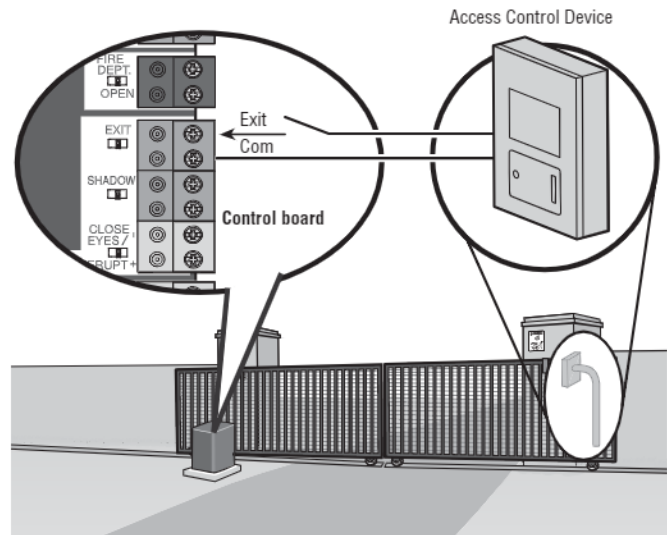

Loop wiring

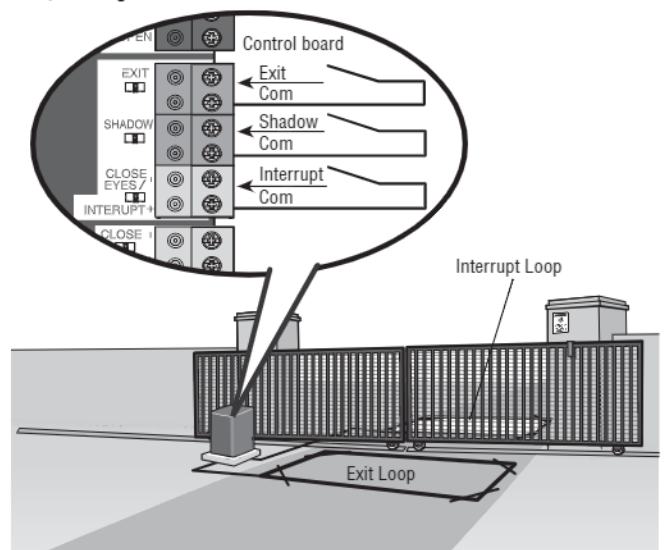

# ACCESSORY WIRING

## Locks

### Maglock (2 Terminals, N.C. and COM)

Relay contact output, Normally - closed (N.C.) output for maglocks.

Relay activates prior to motor activation and during motor run. Relay is off when motor is off.

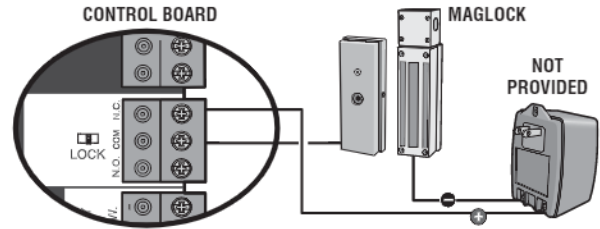

## Miscellaneous Wiring

### Three button control station (4 Terminals)

- OPEN and COM: Opens a closed gate. Hard open (maintained switch overrides external safeties and resets alarm condition). If maintained, pauses Timer-to-Close at OPEN limit. Opens a closing gate and holds open an open gate (within line-of-sight).
- CLOSE and COM: Closes an open gate. Hard close (maintained switch overrides external safeties and resets alarm condition within line-of-sight)
- STOP and COM: Stops a moving gate. Hard stop (maintained switch overrides Open and Close commands and resets alarm condition). If maintained, pauses Timer-to-Close at OPEN limit. Overrides Open and Close commands (within line-of-sight).

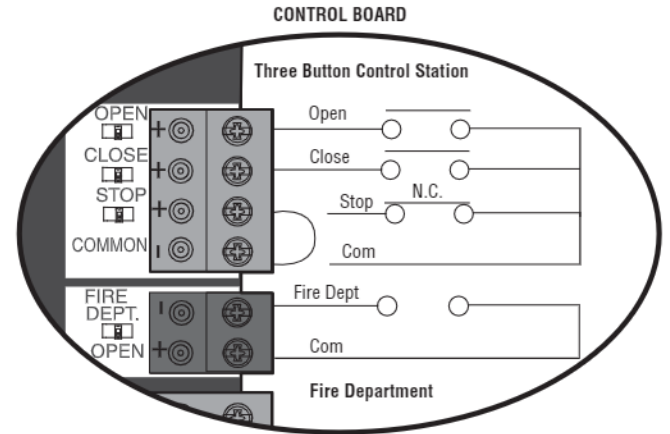

### Fire department open input (2 Terminals)

Acts as hard open.

Maintained input overrides (ignores) external safeties (photoelectric sensor and edge), pauses Timer-to-Close momentary input logic as single button control and safeties remain active, re-enables Timer-to-Close.

### Accessory power class 2 supply 24 VDC, MAX 1 Amp (4 Terminals)

- SWITCHED: Switched ON with gate motion and at the open limit when Timer-to-Close is active. Turns off 5 seconds after motion.
- UNSWITCHED: 24 Vdc voltage out to power accessories, always ON.

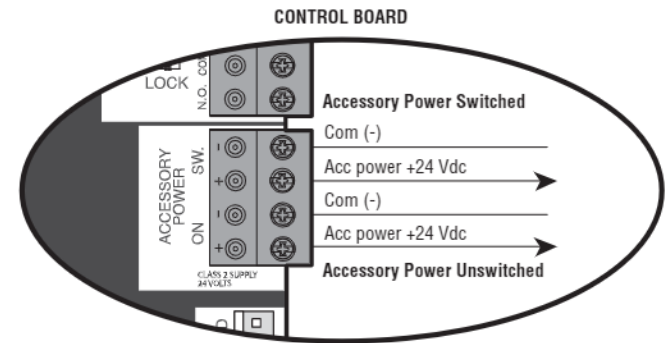

## Terminal Block

The terminal block provides additional space for accessory wiring.

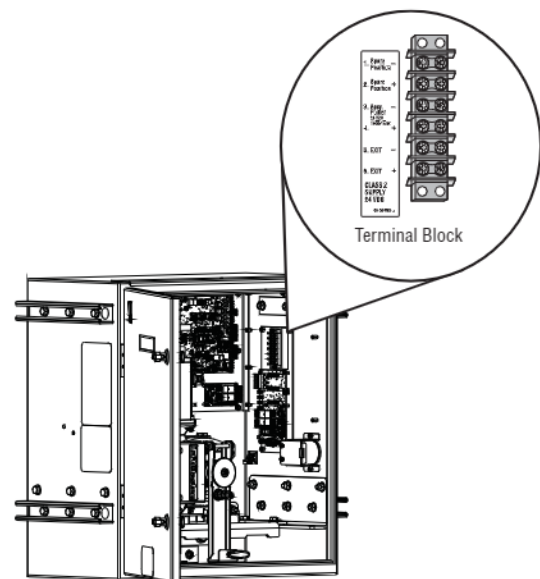



# EXPANSION AND RELAY ADAPTER BOARDS

## ⚠ CAUTION

- To AVOID damaging the circuit board, relays or accessories, DO NOT connect more than 42 Vdc (32 Vac) to the AUX relay contact terminal blocks.

### Expansion and Relay Adapter Boards Overview

#### 1. QUICK CLOSE switch:

OFF: No change to the gate's normal operation.  
ON: When CLOSE EYES/Interrupt loop is deactivated it causes an opening or a stopped gate to close (ignores the Timer-to-Close).

#### 2. AC FAIL switch:

OPEN: Loss of AC power will cause the gate to open approximately 15 seconds after AC power fail and remain OPEN until AC power is restored (enabling the Timer-to-Close).

BATT: With loss of AC power, gate will remain in present position and operator is powered from batteries.

#### 3. EXIT FAIL switch:

When set to OPEN, if the EXIT plug-in loop detector (Model LOOPDETLM) detects a fault, then the gate will open and remain open until fault is cleared. When set to CLOSE, then plug-in EXIT loop detector faults are ignored (EXIT loop is faulted and inoperative).

#### 4. ANTI-TAIL switch:

OFF: When CLOSE EYES/Interrupt loop is activated it causes a closing gate to stop and reverse.

ON: When CLOSE EYES/Interrupt loop is activated it causes a closing gate to pause. Once the vehicle is clear the gate will continue to close.

#### 5. AUX RELAY switches:

Set the AUX RELAY switches as needed to obtain the desired function as shown on the following page.

#### 6. EYE/EDGE switches:

Set the EYE/EDGE switches as needed to obtain the desired OPEN or CLOSE functionality.

#### 7. 1, 2, and 3 LEDs:

LEDs indicating the status of the EYE/EDGE inputs. Also used to check the firmware version of the expansion board:

- Locate the 1, 2, and 3 LEDs on the expansion board.
- Disconnect AC/DC power to the control board for 15 seconds.
- Connect power. The 1, 2, and 3 LEDs will flash in sequence until the control board firmware revision is displayed. When the green POWER LED glows solid the LED 1 will flash the version number, then stop, then the LED 2 will flash the revision number (for example: For version 5.1 when the green POWER LED is solid the LED 1 will flash 5 times, then stop, then the LED 2 will flash once).

#### 8. J6 and J7 inputs:

Communication bus connects control board, expansion board, or relay adapter board. Also connects LiftMaster wireless edge receiver LMWEKITU. **NOTE: ONLY one wireless edge receiver may be connected to an operator. Up to 4 wireless edge transmitters LMWETXU may be programmed to the receiver.**

#### 9. Input LEDs:

LEDs indicating the status of the SBC, OPN, CLS, and STP inputs.

#### 10. Loop detector inputs:

Inputs for the Plug-In Loop Detectors (Model LOOPDETLM)

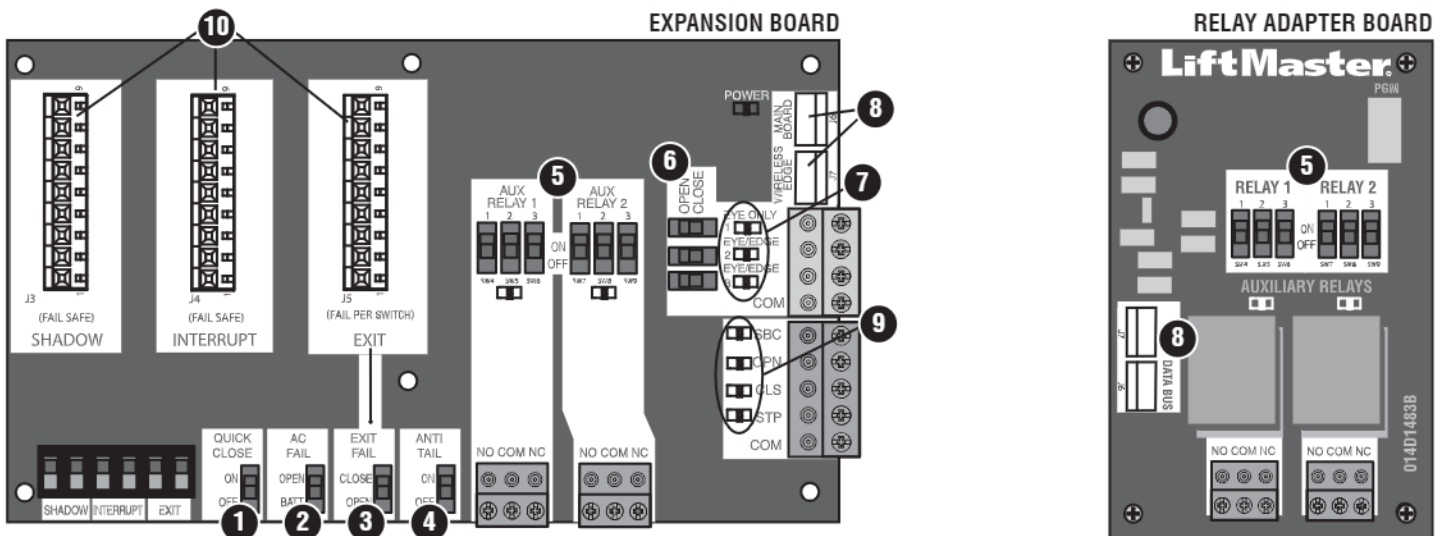

# EXPANSION AND RELAY ADAPTER BOARDS

## Auxiliary Relays

The expansion board and relay adapter board provide Normally Open (N.O.) and Normally Closed (N.C.) relay contacts to control external devices, for connection of Class 2, low voltage (42 Vdc [34 Vac] max 5 Amps) power sources only. Function of relay contact activation determined by switch settings.

AUX RELAY SETTING	SWITCH SETTINGS			AUX RELAY 1	AUX RELAY 2
	1	2	3		
Off (no feature selected)	OFF	OFF	OFF	Relay always off. Use this Aux Relay setting to conserve battery power.	
Open Limit Switch	OFF	OFF	ON	Energizes at open limit. Use with SAMS (Sequenced Access Management System, jointly with barrier gate).	
Close Limit Switch	OFF	ON	OFF	Energizes when not at close limit. For an additional audible or visual display, connect an external light (low voltage).	
Gate Motion	OFF	ON	ON	Energizes when motor is on (gate in motion). For an additional audible or visual display, connect an external buzzer or light (low voltage).	
Pre-Motion Delay - Expansion Board Only	ON	OFF	OFF	Energizes 3 seconds before gate motion and remains energized during gate motion. The onboard alarm will sound. For an additional audible or visual display, connect an external buzzer or light (low voltage).	Energizes 3 seconds before gate motion and remains energized during gate motion. For an additional audible or visual display, connect an external buzzer or light (low voltage).
Power	ON	ON	OFF	Energizes when AC power or solar power is present. There is approximately a 10-12 second delay before relay cutoff, after AC shutdown.	Energizes when on battery power. There is approximately a 10-12 second delay before relay cutoff, after AC shutdown.
Tamper	ON	OFF	ON	Energizes if gate is manually tampered with by being pushed off of close limit. For an additional audible or visual display, connect an external buzzer or light (low voltage).	
Cycle Count - Expansion Board Only	ON	ON	ON	The 1, 2, and 3 LEDs will blink out the cycle count (cycle count is stored on the control board). See below.	Red/green light functionality, see below.

### \* Cycle count

First, note the current Aux Relay switch positions. To determine the actual cycles that the gate operator has run (in thousands), set all three Aux Relay switches to the ON setting for Aux Relay 1. The Expansion Board's 1, 2, and 3 LEDs will blink out the cycle count, with 1 LED blinking 1000's, 2 LED blinking 10,000's, 3 LED blinking 100,000's, and simultaneously all three LED's blink 1,000,000's (e.g. 1 LED blinks 3 times, 2 LED blinks 6 times, and 3 LED blinks once. Cycle count is 163,000.). Cycle count displayed is between 1,000 and 9,999,000 cycles. After servicing, set Aux Relay switches back to their appropriate positions. Cycle count cannot be reset or changed. If under 1,000 cycles the 1, 2, and 3 LEDs will turn on for 10 seconds, then turn off.

**NOTE:** The expansion board will flash the cycle count 3 times then all the LEDs will turn on solid for 10 seconds then turn off.

RED/GREEN LIGHT FUNCTIONALITY					
Red light wired to AUX RELAY 1. Green light wired to AUX RELAY 2.					
GATE STATE	AUX RELAY 1 SWITCHES			AUX RELAY 2 SWITCHES	
	1 OFF	2 OFF	3 OFF	1 ON	2 ON
Closed	Red light OFF*			Green light OFF	
Opening	Red light ON/Flash			Green light OFF	
Open	Red light OFF			Green light ON	
Closing	Red light ON/Flash			Green light OFF	
Defined Mid Stop	n/a			n/a	
Undefined Mid Stop	Red light ON			Green light OFF	
Timer more than 5 seconds	Red light OFF			Green light ON	
Timer less than 5 seconds	Red light ON/Flash			Green light OFF	

\* For red light ON when gate is closed, set switch 1 on AUX RELAY 1 to ON

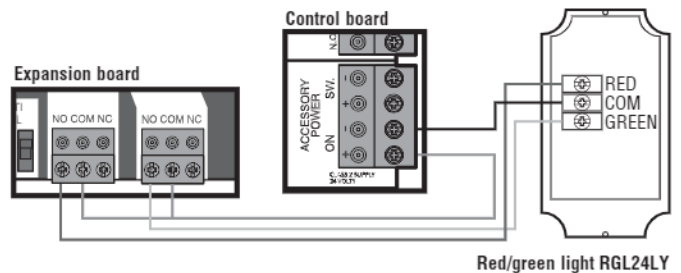
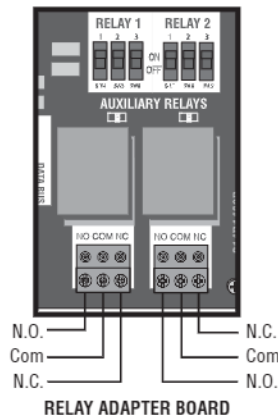
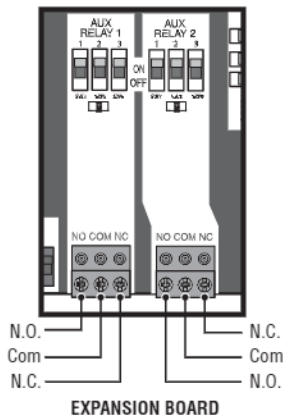

# EXPANSION AND RELAY ADAPTER BOARDS

## Wiring Accessories to the Expansion Board

Refer to the chart below and the corresponding image for a description of the expansion board inputs.

1	Wireless edge, control board, or relay adapter board	Connection for wireless edge receiver, control board or relay adapter board. <b>NOTE: ONLY one wireless edge receiver may be connected to an operator. Up to 4 wireless edge transmitters LMWETXU may be programmed to the receiver.</b>
2	Entrapment Protection Device Inputs (4 terminals total), Open or Close Direction based on switch setting next to inputs	EYES ONLY Input: Open or Close Direction Photoelectric Sensors, Close: reverses fully, Open: reverses 4 seconds. EYES/EDGE Input(s): Open or Close Direction Photoelectric Sensors, Infra-red detector wired or Edge Sensor, Close: reverses fully, Open: reverses 4 seconds.
3	Single Button Control, SBC (2 terminals)	Gate command sequence - Open, Stop, Close, Stop, ... Soft Open ,Soft Close, Soft Stop (maintained switch does not override external safeties and does not reset alarm condition)
4	Open Input (& common) (3-Button Control Station, 4 terminals total)	Open command - opens a closed gate. Soft open (maintained switch does not override external safeties and does not reset alarm condition) If maintained, pauses Timer-to-Close at OPEN limit. Opens a closing gate and holds open an open gate.
5	Close Input (& common) (3-Button Control Station, 4 terminals total)	Close command - closes an open gate. Soft close (maintained switch does not override external safeties and does not reset alarm condition).
6	Stop Input (& common) (3-PB station, 4 terminals total)	Stop command - stops a moving gate. Hard stop (maintained switch overrides Open and Close commands and resets alarm condition) If maintained, pauses Timer-to-Close at OPEN limit. Overrides an Open or Close command.
7	Exit Loop Input (2 terminals)	Loop wire connection for plug-in loop detector when loop is inside secured area near gate. Open command - opens a closed gate. Soft open (maintained switch does not override external safeties and does not reset alarm condition) If maintained, pauses Timer-to-Close at OPEN limit. Opens a closing gate and holds open an open gate.
8	Shadow Loop Input (2 terminals)	Loop wire connection for plug-in loop detector when loop is positioned under the gate. <ul style="list-style-type: none"> <li>Holds open gate at open limit</li> <li>Disregarded during gate motion</li> <li>Pauses Timer-to-Close at Open Limit</li> </ul>
9	Interrupt Loop Input (2 terminals)	Loop wire connection for plug-in loop detector when loop is along the side of the gate. <ul style="list-style-type: none"> <li>Holds open gate at open limit</li> <li>Stops and reverses a closing gate</li> <li>Pauses Timer-to-Close at Open Limit</li> </ul>

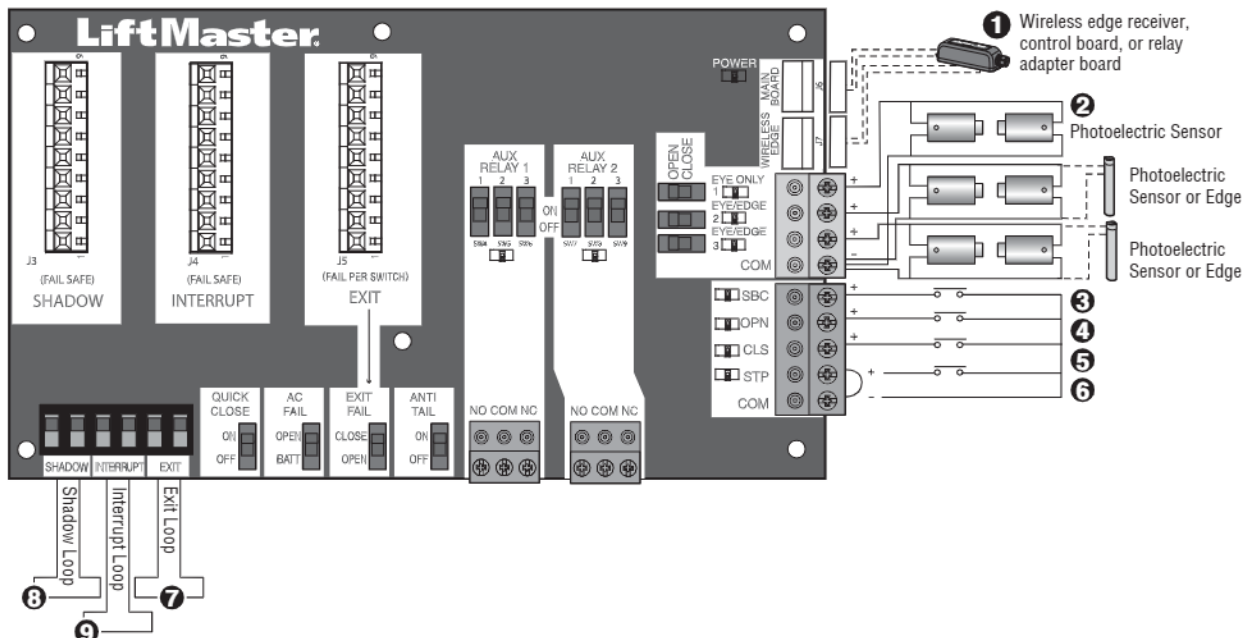

## MAINTENANCE

### IMPORTANT SAFETY INSTRUCTIONS

#### WARNING

To reduce the risk of SEVERE INJURY or DEATH:

- READ AND FOLLOW ALL INSTRUCTIONS.
- ANY maintenance to the operator or in the area near the operator MUST NOT be performed until disconnecting the electrical power (AC or solar and battery) and locking-out the power via the operator power switch. Upon completion of maintenance the area MUST be cleared and secured, at that time the unit may be returned to service.
- Disconnect power at the fuse box BEFORE proceeding. Operator MUST be properly grounded and connected in accordance with national and local electrical codes. **NOTE:** *The operator should be on a separate fused line of adequate capacity.*
- NEVER let children operate or play with gate controls. Keep the remote control away from children.
- ALWAYS keep people and objects away from the gate. NO ONE SHOULD CROSS THE PATH OF THE MOVING GATE.
- The entrance is for vehicles ONLY. Pedestrians MUST use separate entrance.
- **TEST THE GATE OPERATOR MONTHLY.** The gate MUST reverse on contact with an object or reverse when an object activates the noncontact sensors. After adjusting the force, speed, or the limit of travel, retest the gate operator. Failure to adjust and retest the gate operator properly can increase the risk of INJURY or DEATH.
- Use the manual disconnect release ONLY when the gate is NOT moving.
- KEEP GATES PROPERLY MAINTAINED. Read this manual carefully. Have a qualified service person make repairs to gate hardware.
- ALL maintenance MUST be performed by a Trained Gate Systems Technician.
- Activate gate ONLY when it can be seen clearly, is properly adjusted and there are no obstructions to gate travel.
- To reduce the risk of FIRE or INJURY to persons use ONLY LiftMaster part 29-NP712 for replacement batteries.
- **SAVE THESE INSTRUCTIONS.**

#### CAUTION

- ALWAYS wear protective gloves and eye protection when changing the battery or working around the battery compartment.

# MAINTENANCE

## Maintenance Chart

Disconnect all power (AC, solar, battery) to the operator before servicing.

DESCRIPTION	TASK	CHECK AT LEAST ONCE EVERY		
		MONTH	6 MONTHS	3 YEARS
Entrapment Protection Devices	Check and test inherent (built into the operator) and external devices for proper operation	X		
Warning Signs	Make sure they are present and replace if worn or broken, see <i>Accessories</i>	X		
Manual Disconnect	Check and test for proper operation		X	
Sprockets and Chains	Check for excessive slack and lubricate		X	
Gate	Inspect for wear or damage; ensure it still complies with ASTM F2200, see page 5	X		
Accessories	Check all for proper operation		X	
Electrical	Inspect all wire connections		X	
Chassis Mounting Bolts	Check for tightness		X	
Operator	Inspect for wear or damage		X	
Diagnostic History	Review diagnostic history for identification of intermittent problems		X	
Batteries	Replace			X

### NOTES:

- High cycle usage may require more frequent maintenance checks.
- Limits may have to be reset after any major drive chain adjustments.
- If lubricating chain, use only lithium spray. Never use grease or silicone spray.
- It is suggested that while at the site voltage readings be taken at the operator. Using a digital voltmeter, verify that the incoming voltage to the operator is within ten percent of the operator's rating.

## Batteries

Batteries will degrade over time depending on temperature and usage. The operator alarm will beep 3 times with a command if the battery is low. Batteries do not perform well in extremely cold temperatures. For best performance, the batteries should be replaced every 3 years. Use only LiftMaster part 29-NP712 for replacement batteries. The batteries contain lead and need to be disposed of properly.

The operator comes with two 7AH batteries. Two 33AH batteries (A12330SGLPK), with battery harness model K41-0102-000 (not provided), may be used in place of the 7AH batteries.

## Drive Train

Over time, the drive chain on the operator will stretch and need to be tightened. To tighten the drive chain adjust either of the two chain eye bolts. **NOTE:** The chain should have no more than 1 inch of sag for every 10 feet of chain length.

# TROUBLESHOOTING

## ⚡ WARNING

To protect against fire and electrocution:

- DISCONNECT power (AC or solar and battery) BEFORE installing or servicing operator.

For continued protection against fire:

- Replace ONLY with fuse of same type and rating.

## Diagnostic Codes

### To View the Codes

The codes will show on the diagnostic display.

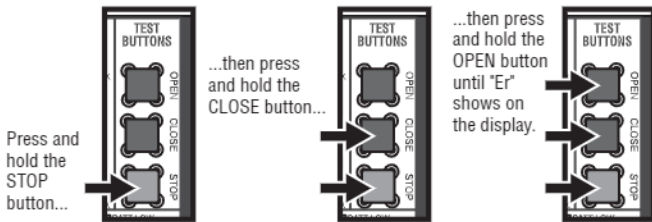

The operator will show the code sequence number followed by the code number:

#### CODE SEQUENCE NUMBER

The first number shown is the most recent code (example: "01"). The display will show the sequence of codes that occurred starting with "01" and going up to code "20".

A SECOND LATER....

#### CODE NUMBER

The second number shown after the code sequence number is the code itself (31-99, example "31"). Refer to the chart on page 55 for an explanation of each code.



### To Scroll Through the Saved Codes

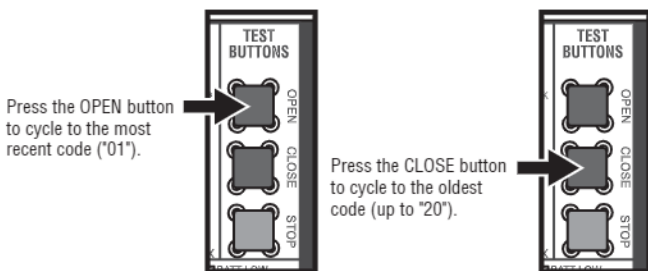

The operator will only keep track of up to 20 codes, then will start saving over the oldest codes as new codes occur.

See the diagnostic codes table page 55.

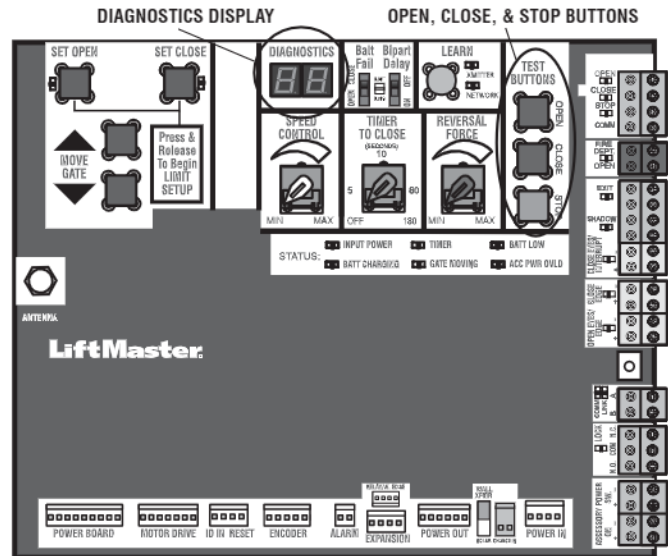

### To Exit

Press and release the STOP button to exit. The display will also time out after two minutes of inactivity.

### To Reset the Code History

1. Press and hold the STOP button for six seconds. The display will show "Er" then "CL" alternately for six seconds.
2. Release the STOP button. The code history has now been reset and the display will show "--" until a new code occurs.
3. Press and release the STOP button to exit.

# TROUBLESHOOTING

## Control Board LEDs

STATUS LEDS		
INPUT POWER	OFF	OFF state
	ON	AC charger or Solar power available
BATT CHARGING	OFF	Not charging
	ON	Three stage battery charging
TIMER	OFF	The timer is disabled
	ON	The timer is enabled
	MEDIUM BLINK (1 blink per second)	The timer is running
	FAST BLINK (2 blinks per second)	The timer is paused
	FASTEST BLINK (8 blinks per second)	The timer is canceled
GATE MOVING	OFF	The gate is stopped
	ON	The gate is opening or closing
	MEDIUM BLINK (1 blink per second)	Operator is in E1 (single entrapment)
	FASTEST BLINK (8 blinks per second)	The operator is in E2 (double entrapment)
BATT LOW	OFF	No battery error
	ON	Battery low
	MEDIUM BLINK (1 blink per second)	Battery critically low
ACC PWR OVLD	OFF	Accessory power is okay
	ON	Accessory overload protector opened

INPUT LEDS		
OPEN, CLOSE, STOP INPUT	OFF	Input inactive
	ON	Input active
	BLINK	Input active on other operator or expansion board
FIRE DEPT INPUT	OFF	Input inactive
	ON	Input active
	BLINK	Input active on other operator
EXIT	OFF	Input inactive
	ON	Input active
	BLINK	Input active on other operator
SHADOW	OFF	Input inactive
	ON	Input active
	BLINK	Input active on other operator
CLOSE EYES/INTERRUPT	OFF	Input inactive
	ON	Input active
	BLINK	Input active on other operator
CLOSE EDGE	OFF	Input inactive
	ON	Input active
	BLINK	Input active on other operator
OPEN EYES/EDGE	OFF	Input inactive
	ON	Input active
	BLINK	Input active on other operator
LOCK	OFF	Maglock relay inactive
	ON	Maglock relay active

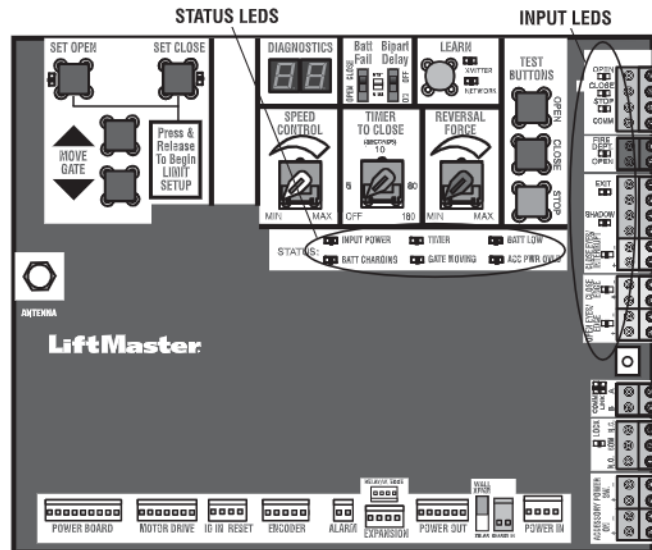

# TROUBLESHOOTING

## Troubleshooting Chart

SYMPTOM	POSSIBLE CAUSES	SOLUTIONS
<b>Operator does not run and diagnostic display not on.</b>	<ul style="list-style-type: none"> <li>a. No power to control board</li> <li>b. Open fuse</li> <li>c. If on battery power only, low or dead batteries</li> <li>d. Inoperable control board</li> <li>e. Inoperable BLDC Motor Drive Board</li> </ul>	<ul style="list-style-type: none"> <li>a. Check AC and battery power</li> <li>b. Check fuses on the BLDC Motor Drive Board</li> <li>c. Charge batteries by AC or solar power or replace batteries</li> <li>d. Replace inoperable control board</li> <li>e. Replace BLDC Motor Drive Board</li> </ul>
<b>Control board powers up, but motor does not run.</b>	<ul style="list-style-type: none"> <li>a. Reset button is stuck in the RESET position</li> <li>b. Jumper is not in place for stop circuit</li> <li>c. If on battery power only, low or dead batteries</li> <li>d. Open or close input active</li> <li>e. Entrapment protection device active</li> <li>f. Vehicle loop detector or probe active</li> <li>g. Inoperable control board</li> <li>h. Inoperable motor or BLDC Motor Drive Board</li> </ul>	<ul style="list-style-type: none"> <li>a. Check reset button</li> <li>b. Put a jumper on the stop circuit</li> <li>c. Charges batteries by AC or solar power or replace batteries</li> <li>d. Check all open and close inputs for a “stuck on” input</li> <li>e. Check all entrapment protection device inputs for a “stuck on” sensor</li> <li>f. Check all vehicle detector inputs for a “stuck on” detector</li> <li>g. Replace inoperable control board</li> <li>h. Replace motor or BLDC Motor Drive Board</li> </ul>
<b>Gate moves, but cannot set correct limits.</b>	<ul style="list-style-type: none"> <li>a. Gate does not move to a limit position</li> <li>b. Gate is too difficult to move</li> <li>c. Limits are set too close</li> </ul>	<ul style="list-style-type: none"> <li>a. Use manual disconnect, manually move gate, and ensure gate moves easily limit to limit. Repair gate as needed.</li> <li>b. Gate must move easily and freely through its entire range, limit to limit. Repair gate as needed.</li> <li>c. Ensure the gate moves at least four feet between the OPEN limit and the CLOSE limit.</li> </ul>
<b>Gate does not fully open or fully close when setting limits.</b>	<ul style="list-style-type: none"> <li>a. Gate does not move to a limit position</li> <li>b. Gate is too difficult to move</li> </ul>	<ul style="list-style-type: none"> <li>a. Use manual disconnect, manually move gate, and ensure gate moves easily limit to limit. Repair gate as needed.</li> <li>b. Gate must move easily and freely through its entire range, limit to limit. Repair gate as needed.</li> </ul>
<b>Operator does not respond to a wired control/command (example: open, close, SBC, etc.)</b>	<ul style="list-style-type: none"> <li>a. Check open and close command input LEDs</li> <li>b. Reset button is stuck</li> <li>c. If on battery power only, low or dead batteries</li> <li>d. Entrapment protection device active</li> <li>e. Vehicle loop detector or vehicle probe active</li> </ul>	<ul style="list-style-type: none"> <li>a. Check all open and close inputs for a “stuck on” input</li> <li>b. Set reset button to NORMAL OPERATION, see page 29</li> <li>c. Charges batteries by AC or solar power or replace batteries</li> <li>d. Check all entrapment protection device inputs for a “stuck on” sensor</li> <li>e. Check all vehicle detector inputs for a “stuck on” detector</li> </ul>
<b>Operator does not respond to a wireless control or transmitter</b>	<ul style="list-style-type: none"> <li>a. Check XMITTER LED when wireless control is active</li> <li>b. Reset button is stuck</li> <li>c. Poor radio reception</li> </ul>	<ul style="list-style-type: none"> <li>a. Activate wireless control and check XMITTER LED is on. Re-learn wireless control/transmitter to control board. Replace wireless control as needed.</li> <li>b. Set reset button to NORMAL OPERATION, see page 29</li> <li>c. Check if similar wired control operates correctly. Check if wireless controls works properly when within a few feet of operator. Check operator’s antenna and antenna wire. Check other wireless controls or devices.</li> </ul>
<b>Gate stops during travel and reverses immediately.</b>	<ul style="list-style-type: none"> <li>a. Control (open, close) becoming active</li> <li>b. Vehicle loop detector active</li> <li>c. Low battery voltage</li> <li>d. Inherent entrapment protection was activated while moving</li> </ul>	<ul style="list-style-type: none"> <li>a. Check all open and close inputs for an active input</li> <li>b. Check all vehicle detector inputs for an active detector</li> <li>c. Battery voltage must be 23 VDC or higher. Charge batteries by AC or solar power or replace batteries</li> <li>d. If there are no obstructions in gate path, manually disconnect the gate, and ensure it moves easily limit to limit. Repair gate as needed.</li> </ul>



# TROUBLESHOOTING

SYMPTOM	POSSIBLE CAUSES	SOLUTIONS
Gate opens, but will not close with transmitter or Timer-to-Close.	<ul style="list-style-type: none"> <li>a. Open control active</li> <li>b. Vehicle loop detector active</li> <li>c. Loss of AC power with AC FAIL set to OPEN</li> <li>d. Low battery with LOW BATT set to OPEN</li> <li>e. Fire dept input active</li> <li>f. Timer-to-Close not set</li> <li>g. Close entrapment protection device active</li> </ul>	<ul style="list-style-type: none"> <li>a. Check all open inputs for an active input</li> <li>b. Check all vehicle detector inputs for an active detector</li> <li>c. Check AC power and AC Fail option setting</li> <li>d. Check if AC power is available. If no AC power, then running on batteries and battery voltage must be 23 Vdc or higher. Charge batteries by AC or solar power or replace batteries.</li> <li>e. Check Fire Dept input</li> <li>f. Check Timer-to-Close (TTC) setting</li> <li>g. Check all entrapment protection device inputs for an active sensor</li> </ul>
Gate closes, but will not open.	<ul style="list-style-type: none"> <li>a. Vehicle loop detector active</li> <li>b. Low battery with LOW BATT option set to CLOSE</li> </ul>	<ul style="list-style-type: none"> <li>a. Check all vehicle detector inputs for an active detector</li> <li>b. Check if AC power is available. If no AC power, then running on batteries and battery voltage must be 23 VDC or higher. Charge batteries by AC or solar power or replace batteries.</li> </ul>
Exit loop activation does not cause gate to open.	<ul style="list-style-type: none"> <li>a. Exit vehicle detector setup incorrectly</li> <li>b. Inoperable exit loop detector</li> <li>c. Low battery with LOW BATT option set to CLOSE</li> </ul>	<ul style="list-style-type: none"> <li>a. Review exit loop detector settings. Adjust settings as needed.</li> <li>b. Replace inoperable exit loop detector.</li> <li>c. Check if AC power is available. If no AC power, then running on batteries and battery voltage must be 23 VDC or higher. Charge batteries by AC or solar power or replace batteries.</li> </ul>
Interrupt loop does not cause gate to stop and reverse.	<ul style="list-style-type: none"> <li>a. Vehicle detector setup incorrectly</li> <li>b. Inoperable vehicle loop detector</li> <li>c. Anti-tail set to ON</li> </ul>	<ul style="list-style-type: none"> <li>a. Review Interrupt loop detector settings. Adjust settings as needed.</li> <li>b. Replace inoperable Interrupt loop detector.</li> <li>c. Set anti-tail to OFF.</li> </ul>
Shadow loop does not keep gate at open limit.	<ul style="list-style-type: none"> <li>a. Vehicle detector setup incorrectly</li> <li>b. Inoperable vehicle loop detector</li> </ul>	<ul style="list-style-type: none"> <li>a. Review shadow loop detector settings. Adjust settings as needed.</li> <li>b. Replace inoperable shadow loop detector.</li> </ul>
Obstruction in gate's path does not cause gate to stop and reverse.	<ul style="list-style-type: none"> <li>a. Force adjustment needed</li> </ul>	<ul style="list-style-type: none"> <li>a. Refer to the <i>Adjustment</i> section to conduct the obstruction test and perform the proper force adjustment that is needed.</li> </ul>
Photoelectric sensor does not stop or reverse gate.	<ul style="list-style-type: none"> <li>a. Incorrect photoelectric sensor wiring</li> <li>b. Inoperable photoelectric sensor</li> </ul>	<ul style="list-style-type: none"> <li>a. Check photoelectric sensor wiring. Retest that obstructing photoelectric sensor causes moving gate to stop, and may reverse direction.</li> <li>b. Replace inoperable photoelectric sensor. Retest that obstructing photoelectric sensor causes moving gate to stop, and may reverse direction.</li> </ul>
Edge sensor does not stop or reverse gate.	<ul style="list-style-type: none"> <li>a. Incorrect edge sensor wiring</li> <li>b. Inoperable edge sensor</li> </ul>	<ul style="list-style-type: none"> <li>a. Check edge sensor wiring. Retest that activating edge sensor causes moving gate to stop and reverse direction.</li> <li>b. Replace inoperable edge sensor. Retest that activating edge sensor causes moving gate to stop and reverse direction.</li> </ul>
Alarm sounds for 5 minutes or alarm sounds with a command.	<ul style="list-style-type: none"> <li>a. Double entrapment occurred (two obstructions within a single activation)</li> </ul>	<ul style="list-style-type: none"> <li>a. Check for cause of entrapment (obstruction) detection and correct. Press the reset button to shut off alarm and reset the operator.</li> </ul>
Alarm beeps three times with a command.	<ul style="list-style-type: none"> <li>a. Low battery</li> </ul>	<ul style="list-style-type: none"> <li>a. Check if AC power is available. If no AC power, then running on batteries and battery voltage must be 23 Vdc or higher. Charge batteries by AC or solar power or replace batteries</li> </ul>
Alarm beeps when running.	<ul style="list-style-type: none"> <li>a. Expansion board setting</li> <li>b. Constant pressure to open or close is given</li> </ul>	<ul style="list-style-type: none"> <li>a. Pre-warning is set to "ON"</li> <li>b. Constant pressure to open or close is given</li> </ul>
Expansion board function not controlling gate.	<ul style="list-style-type: none"> <li>a. Inoperable control board to expansion board wiring</li> <li>b. Incorrect input wiring to expansion board</li> <li>c. Inoperable expansion board or inoperable control board</li> </ul>	<ul style="list-style-type: none"> <li>a. Check control board to expansion board wiring. If required, replace wire cable.</li> <li>b. Check wiring to all inputs on expansion board.</li> <li>c. Replace inoperable expansion board or control board.</li> </ul>

# TROUBLESHOOTING

SYMPTOM	POSSIBLE CAUSES	SOLUTIONS
<b>Maglock not working correctly.</b>	a. Maglock wired incorrectly	a. Check that maglock is wired to N.C. and COM terminals. Check that maglock has power (do not power maglock from control board accessory power terminals). If shorting lock's NO and COM wires does not activate maglock, then replace maglock or maglock wiring (refer to wiring diagram).
<b>Solenoid lock not working correctly.</b>	a. Solenoid wired incorrectly	a. Check that solenoid is wired to N.O. and COM terminals. Check that solenoid has power (do not power solenoid from control board accessory power terminals). If shorting lock's NC and COM wires does not activate solenoid, then replace solenoid lock or solenoid wiring (refer to wiring diagram).
<b>Switched (SW) accessory power remaining on.</b>	a. In limit setup mode	a. Learn the limits
<b>Accessories connected to switched (SW) accessory power not working correctly, turning off, or resetting.</b>	a. Normal behavior	a. Move accessory to accessory power "ON"
<b>Accessories connected to Accessory power not working correctly, turning off, or resetting.</b>	a. Accessory power protector active b. Inoperable control board	a. Disconnect all accessory powered devices and measure accessory power voltage (should be 23 – 30 Vdc). If voltage is correct, connect accessories one at a time, measuring accessory voltage after every new connection. b. Replace inoperable control board
<b>Quick close not working correctly.</b>	a. Quick close setting incorrect b. Interrupt loop detector c. Inoperable expansion board	a. Check that quick close setting is ON b. Check operation of interrupt loop detector c. Replace inoperable expansion board
<b>Anti-tailgating not working correctly.</b>	a. Anti-tail setting incorrect b. Interrupt loop detector c. Inoperable expansion board	a. Check that anti-tail setting is ON b. Check operation of Interrupt loop detector c. Replace inoperable expansion board
<b>AUX relay not working correctly.</b>	a. AUX relay setting incorrect b. AUX relay wiring incorrect c. Inoperable expansion board or relay adapter board	a. Check AUX relay switches settings b. Check that wiring is connected to either N.O. and COM or to N.C. and COM. c. Set AUX relay to another setting and test. Replace inoperable expansion board or relay adapter board.
<b>Solar operator not getting enough cycles per day.</b>	a. Insufficient panel wattage b. Excessive accessory power draw c. Old batteries d. Solar panels are not getting enough sunlight	a. Add more solar panels b. Reduce the accessory power draw by using LiftMaster low power accessories c. Replace batteries d. Relocate the solar panels away from obstructions (trees, buildings, etc.)
<b>Solar operator, insufficient standby time.</b>	a. Insufficient panel wattage b. Excessive accessory power draw c. Battery capacity too low	a. Add more solar panels b. Reduce the accessory power draw by using LiftMaster low power accessories c. Use batteries with higher amp hour (AH) rating

# SOLAR PANELS

## Solar Panel(s)

SOLAR PANELS ARE NOT PROVIDED. SEE ACCESSORIES

**NOTE:** The use of photoelectric sensor heaters (models LMRRUL and LMTBUL) is NOT recommended in solar applications.

### Solar Application Requirements

- A minimum of two 10W solar panels in series (Model SP10W12V).
- A maximum of six 10W solar panels (Model SP10W12V).
- A heater cannot be used with a solar application.

### Solar Zones

Solar panel recommendations are based upon the average solar radiation and the temperature effects on batteries in the given zones as shown on the map below. Local geography and weather conditions may require additional solar panels. Solar powered gate operator installations are not supported in northern climates due to cold weather and a reduced number of hours of sunlight during the winter months. The cycles/day ratings are approximations. Ratings vary based on gate construction, installation, and temperature. Solar panels cannot be installed in areas that experience long periods of heavy fog, lake effect snow, or rain.

- 1 ZONE 1 (6 Hours of Sunlight/Day): Ideal for solar application
- 2 ZONE 2 (4 Hours of Sunlight/Day): Recommended for solar application
- 3 ZONE 3 (2 Hours of Sunlight/Day): Success of solar application will depend on type of gate operator and location of the solar panel
- NOT AVAILABLE



# SOLAR PANELS

## Solar usage guide

All performance metrics are estimates and are subject to change at any time. Actual results will vary due to variables specific to the site.

**NOTE:** For additional details and specifications on solar usage, please refer to liftmaster.com.

Typical System Standby Battery Current Consumption (mA)	
System voltage	24V
Control board with no radios programmed	2.7 mA
One or more LiftMaster® remote controls programmed	+1 mA
myQ® device or wireless dual gate programmed	+2.4 mA
Expansion board	+11.1 mA
Relay adapter board	+11.1 mA
Per loop detector LOOPDETLM (up to 3 loop detectors can be plugged in to the expansion board)	+3.8 mA
Add up current draw by feature and accessory to determine total current draw	

**NOTE:** The use of photoelectric sensor heaters (models LMRRUL and LMTBUL) is NOT recommended in solar applications.

INSL24UL SOLAR GATE CYCLES PER DAY - 1,000 lb. gate 20 ft. travel							
	BATTERY CURRENT DRAW (mA)	ZONE 1 (6 Hrs Sunlight/Day)		ZONE 2 (4 Hrs Sunlight/Day)		ZONE 3 (2 Hrs Sunlight/Day)	
		7AH batteries	33AH batteries	7AH batteries	33AH batteries	7AH batteries	33AH batteries
		20W SOLAR PANEL	5	20	23	12	14
15	18		22	10	12		
20	18		21		12		
50	13		16				
100							
40W SOLAR PANEL	5	38	53	23	32		13
	15	36	51	21	30		12
	20	35	50	20	29		11
	100	20	34		15		
	200		17				
60W SOLAR PANEL	5	47	84	28	51	12	21
	15	45	82	26	49	10	20
	20	44	81	26	48		19
	100	29	63	12	32		
	250		33				

IHSL24UL SOLAR CYCLES PER DAY - 3,000 lb. gate 20 ft travel							
	BATTERY CURRENT DRAW (mA)	ZONE 1 (6 Hrs Sunlight/Day)		ZONE 2 (4 Hrs Sunlight/Day)		ZONE 3 (2 Hrs Sunlight/Day)	
		7AH batteries	33AH batteries	7AH batteries	33AH batteries	7AH batteries	33AH batteries
		20W SOLAR PANEL	5		11		
15			10				
20							
50							
100							
40W SOLAR PANEL	5	18	25	11	15		
	15	17	24		14		
	20	16	23		14		
	100		16				
	200						
60W SOLAR PANEL	5	22	39	13	24		
	15	21	38	12	23		
	20	20	38	12	22		
	100	13	30		15		
	250		15				

# SOLAR PANELS

## Position

The location of the panel(s) is critical to the success of the installation. In general, the panel(s) should be mounted using the provided angle bracket facing **due south**. The solar panel(s) should be mounted in an area clear of all obstructions and shade from buildings and trees. If the panel(s) is not casting a shadow, the battery is not being charged.

**NOTE:** Tall trees or buildings that do not shade the solar panel(s) in the summer could shade the solar panel(s) during the winter months when the sun sits lower in the sky.

MAXIMUM WIRE LENGTH			
AMERICAN WIRE GAUGE (AWG)	20 WATTS OF PANELS	40 WATTS OF PANELS	60 WATTS OF PANELS
16	235 (71.6 m)	115 (35.1 m)	80 (24.4 m)
14	375 (114.3 m)	190 (57.9 m)	125 (38.1 m)
12	600 (182.9 m)	300 (91.4 m)	200 (61 m)
10	940 (286.5 m)	475 (144.8 m)	315 (96 m)

*Chart assumes: copper wire, 65°C, 5% drop, 30V nominal*

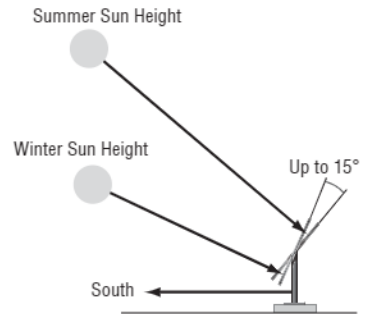
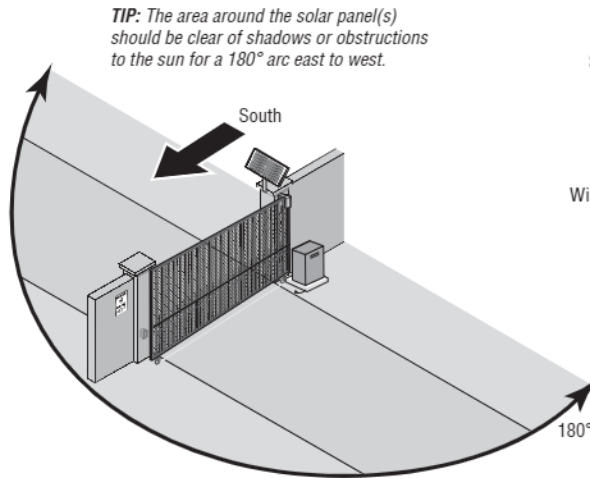

**TIP:** To optimize the system for winter operation the angle can be increased an additional 15° (solar panel(s) sits more vertical).

## Installation

Solar panel(s) **MUST** be installed facing south. Use a compass to determine direction. Below are general instructions for installing the solar panel(s). Your installation may vary slightly depending on the solar panel purchased.

1. Position the mounting bracket on the mounting surface. Mark and drill holes.
2. Secure the solar panel to the mounting bracket using the hex bolts, hex nuts and washers provided.
3. Secure the solar panel to the mounting surface using lag screws provided.

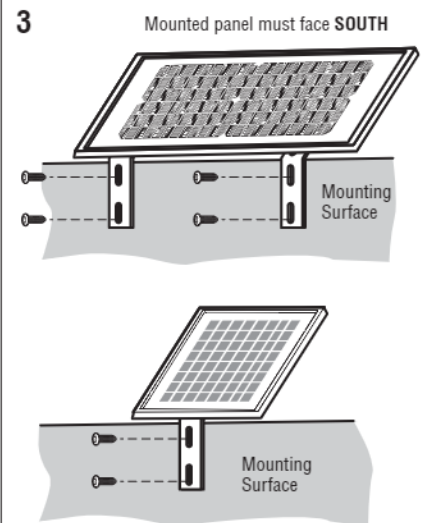
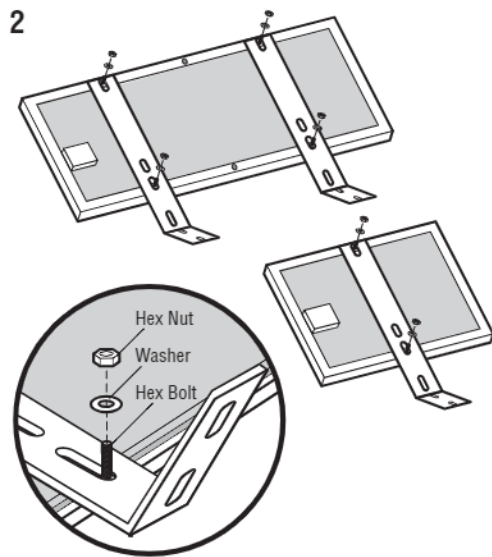
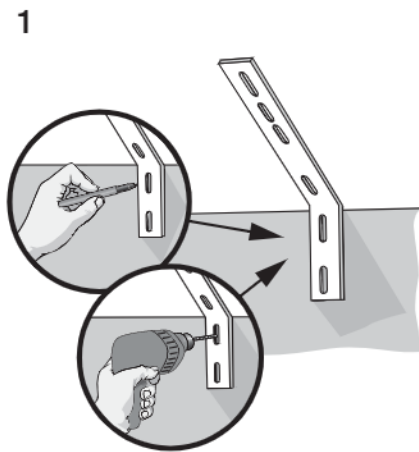

# SOLAR PANELS

## Wire the Solar Panels and Batteries

20W min. - 60W max. for solar applications.

**NOTE:** 33AH batteries are strongly recommended for optimal solar performance.

1. Connect (+) wire from solar panels to (+) pin on CHARGE IN connector on control board.
2. Connect (-) wire from solar panels to (-) pin on CHARGE IN connector on Control board.
3. Set the WALL XFMR/SOLAR switch to SOLAR.

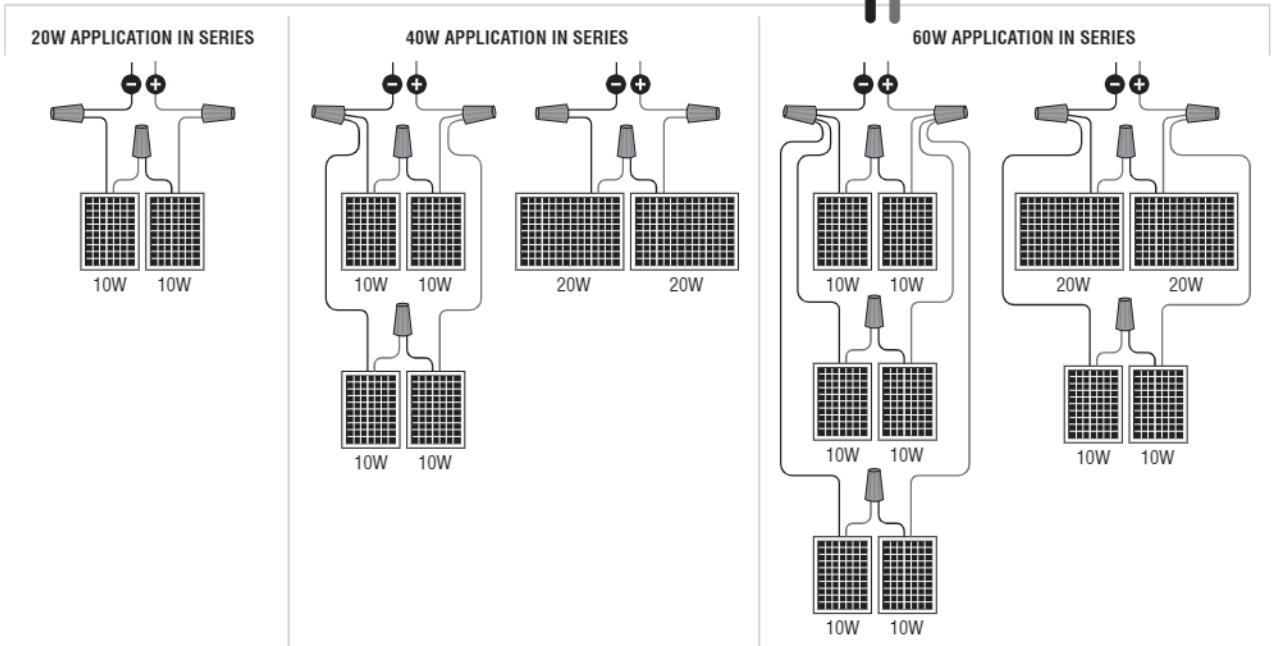
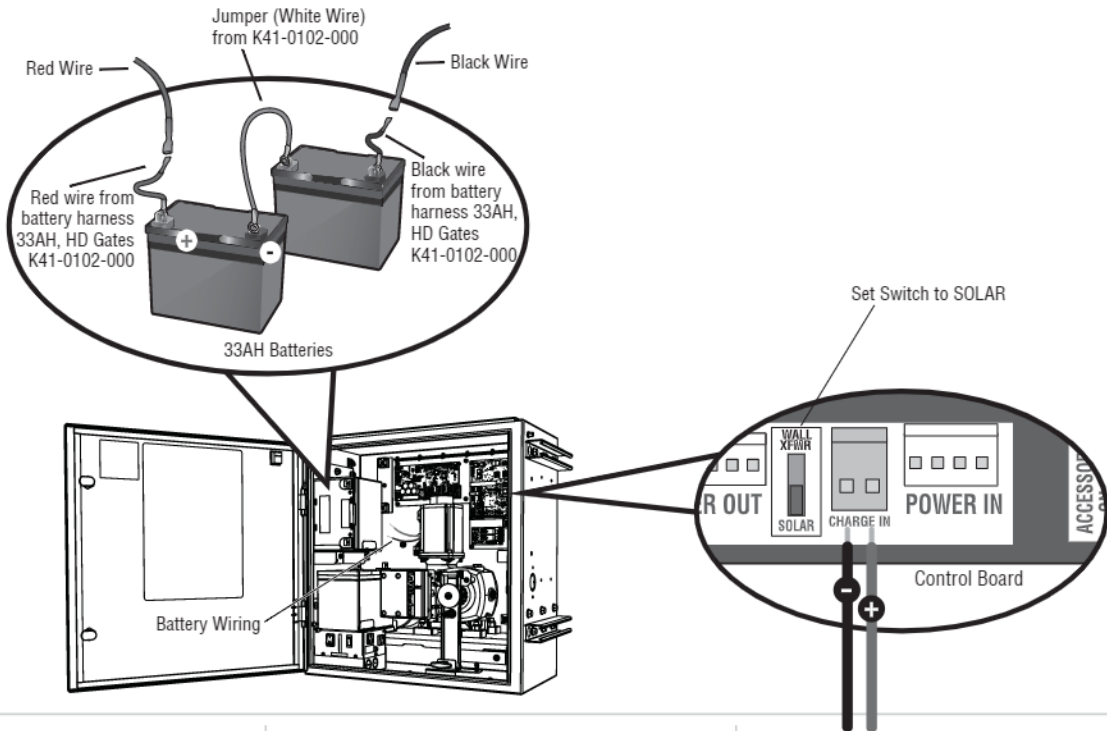

# REPAIR PARTS



**Idler Sprocket (QTY 2)**  
IHSL24UL - K41-0240-000  
INSL24UL - K41-0239-000

**BLDC Motor Drive Board**  
IHSL24UL - K41-0245-000  
INSL24UL - K41-0244-000

**Control Board**  
K41-0073-000



**Limit System**  
IHSL24UL, INSL24UL - K41-0247-000

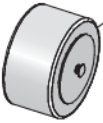

**Transformer**  
IHSL24UL - K41-0241-000  
INSL24UL - K41-0346-000



**EMI Board**  
K1D7078



**Relay Adapter Board**  
K41-0072-000

**Alarm**  
IHSL24UL, INSL24UL - K41-0248-000

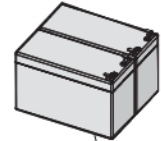

**Battery, 7AH 12 Vdc**  
K74-30762 (1)  
29-NP712 (2)



**Output Sprocket**  
IHSL24UL - K41-0243-000  
INSL24UL - K41-0242-000

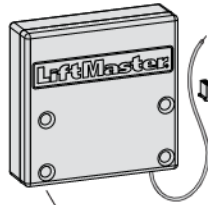

**Limit System Encoder**  
IHSL24UL, INSL24UL - K41-0246-000



**Expansion Board**  
K1D8387-1CC

**Bridge Rectifier**  
K41-0083-000

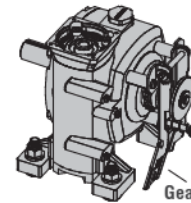

**Gear Reducer**  
IHSL24UL - K41-0252-000  
INSL24UL - K41-0251-000

**Motor**  
IHSL24UL - K41-0254-000  
INSL24UL - K41-0253-000

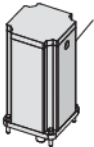

**Interlock Assembly**  
IHSL24UL - K41-0256-000  
INSL24UL - K41-0255-000



## NOT SHOWN

K41-0257-000	Harness kit, IHSL24UL, INSL24UL
K94-34778	Wire Harness - Control Board to Expansion Board
19-40240D	#40 Chain - 10 feet
19-50310	#40 Master Link
K77-36764	Hardware Kit (chain bolt and chain bracket)
K07-50637	Chain Bolt
K41-0102-000	33AH Battery Harness
40-39235	Warning Sign
K41-0249-000	Power Control and Relay Board Mounting Plate
K41-0250-000	Expansion Board and Terminal Block Mounting Plate
K41-0259-000	Chain Guard, IHSL24UL, INSL24UL
K41-0258-000	Idler Bracket Kit, IHSL24UL, INSL24UL
19-3025	#50 Nickel Plated Chain - 25' IHSL24U
19-50ML	#50 Master Link
K10-30699-1	Mounting Bracket

# ACCESSORIES

## Entrapment Protection

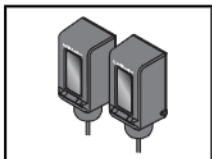

**LiftMaster monitored through beam photoelectric sensor**

Model LMTBUL

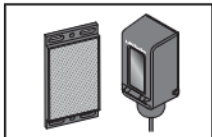

**LiftMaster monitored retro-reflective photoelectric sensor**

Model LMRRUL

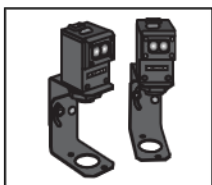

**LiftMaster Monitored Commercial Protector System®**

Models CPS-UN4 and CPSUN4G

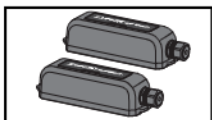

**LiftMaster monitored wireless edge kit (transmitter and receiver)**

Model LMWEKITU

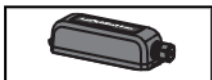

**LiftMaster monitored wireless edge transmitter**

Model LMWETXU

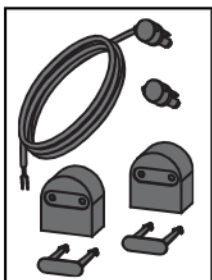

**Large profile monitored edge (82 ft. roll)**

Model L50

**Large profile ends kit (10 pair)**

Model L50E

**Small profile monitored edge (82 ft. roll)**

Model S50

**Small profile ends kit (10 pair)**

Model S50E

### Plastic channel

8 ft. (2.4 m) for both small and large profile edges (pack of 10).

Model L50CHP

### Aluminum channel

10 ft. (3.1 m) for both small and large edge profiles (pack of 8).

Model L50CHAL

### LiftMaster large profile monitored edges (4ft., 5ft., 6ft.)

Model L504AL, L505AL, L506AL

## Remote Controls

*LiftMaster offers a variety of LiftMaster remote controls to satisfy your application needs. Single-button to 4-button, visor or key chain. The following remote controls are compatible with operators manufactured by LiftMaster after 1993. Contact your authorized LiftMaster dealer for additional details and options.*



### 3-button remote control

The 3-button remote control can be programmed to control the operator. Includes visor clip.

Model 893MAX



### 3-button mini-remote control

The 3-button remote control can be programmed to control the operator. Includes key ring and fastening strip.

Model 890MAX

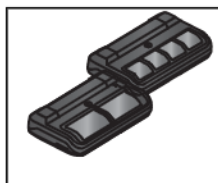

### Security+ 2.0® learning remote controls

One button can control a gate operator and the other(s) can control garage door(s). It can also be programmed to Security+® or Security+ 2.0® code format.

Models 892LT and 894LT

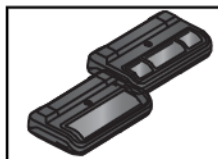

### Programmable DIP Remote Controls

Ideal for applications requiring a large number of remote controls.

Models 811LMX and 813LMX



### Keyless entry

Enables homeowner to operate gate operator from outside by entering a 4-digit code on a specially designed keypad.

Model 878MAX



### Wireless commercial keypad

Durable wireless keypad with blue LED backlight metal keypad, zinc-alloy metal front cover and 5 year 9V lithium battery. Security+ 2.0® compatible.

Model KPW250



### Commercial access control receiver

Access control receiver for up to 1,000 devices (any combination of remote controls and wireless keyless entries).

Model STAR1000



# ACCESSORIES

## Miscellaneous



### Remote antenna extension kit

The remote antenna extension kit allows the antenna to be remotely installed.

Model 86LM

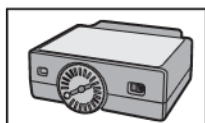

### Plug-in loop detector

Low power. Conveniently plugs into existing control board. Not to be used as entrapment protection.

Model LOOPDETLM

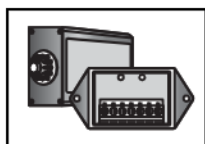

### Loop detector

Low power loop detectors mounted and wired separately inside control box. LiftMaster low power accessory. Not to be used as entrapment protection.

Model LD7LP

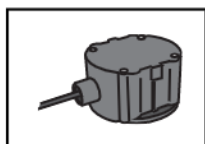

### Vehicle sensing probe

The vehicle sensing probe is buried in the ground and can detect a car as it approaches and will then open the gate.

Model CP4



### Solar panel kit

This kit is to replace or add a solar panel to the operator application. 60W maximum for 24 Vdc operators and 30W maximum for 12 Vdc operators. Models SP10W12V (10 Watt, 12V) and SP20W12V (20 Watt, 12V)



### Magnetic gate lock

Outdoor magnetic lock, transformer, junction box, mounting plate and hardware. Not for use with Solar Applications. Must be powered separately.

Model MG1300

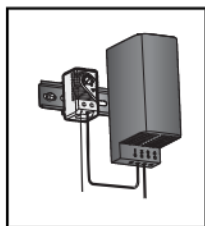

### Heater

The heater keeps the gearbox and batteries at a suitable temperature when the outside temperature is below -4°F (-20°C). The thermostat MUST be set between 45°F and 60°F (7°C and 15.5°C) to ensure proper gate operation. The heater can be powered by 110 to 250 Vac.

Model HTR

### Solenoid lock harness kit

Model K77-37972

### Warning sign

Model 40-39235

### #50 Chain Drive Sprocket

(Model INSL24UL ONLY)

Model INSL50CH

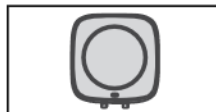

### Long range RFID reader

Model LMSC1000



### LiftMaster® Internet Gateway

Internet enabled accessory which connects your gate operator to your WiFi network and allows you to monitor and control gate operators and lighting accessories enabled by myQ® technology.

Model 828LM



### myQ® Business™ connected access protocol - high capacity

Models CAPXLV and CAPXM

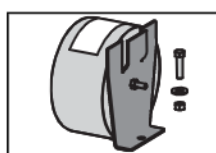

### Transformer kit

Changes input voltage (208/240/480/575 Vac) to an output voltage of 120 Vac. Rated 208/240/480/575 Vac, 5.2/4.5/2.3/1.9 A, 60 Hz, 1 PH

Model 3PHCONV

## Batteries

Gate access system batteries replace or upgrade the gate operator batteries. Two identical 12 Vdc batteries are required for each gate operator. Do not mix 7AH and 33AH batteries within a gate operator.

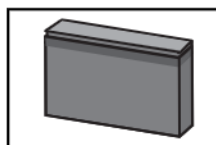

### 7AH batteries

Standard 7 AMP-Hour Battery, 12 Vdc, to replace original batteries provided with operator. Reuse existing harnesses.

Models 29-NP712 (2) and K74-30762 (1)

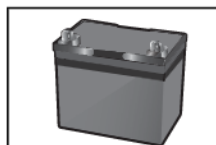

### 33AH batteries

Upgrade 33 AMP-Hour Battery, 12 Vdc. Ideal for solar applications and extended battery backup. Two required.

Model A12330SGLPK

Must use INBAT33 - mounting bracket.

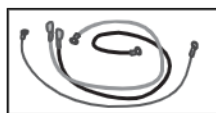

### Battery harness, 33AH, HD Gates

For 33AH battery applications.

Model K41-0102-000

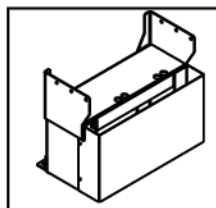

### Riser

Riser for elevating operator for pad mounting and retrofit to most SL585 applications.

Model MRIN

# WARRANTY

## LiftMaster 5 Year Limited Commercial Warranty

LiftMaster ("Seller") warrants to the first purchaser of this product, for the structure in which this product is originally installed, that it is free from defect in materials and/or workmanship for a period of 5 year commercial installation from the date of purchase [and that the INSL24UL and IHSL24UL is free from defect in materials and/or workmanship for a period of 5 year commercial installation from the date of purchase]. The proper operation of this product is dependent on your compliance with the instructions regarding installation, operation, maintenance and testing. Failure to comply strictly with those instructions will void this limited warranty in its entirety.

If, during the limited warranty period, this product appears to contain a defect covered by this limited warranty, call **1-800-528-2806**, toll free, before dismantling this product. Then send this product, pre-paid and insured, to our service center for warranty repair. You will be advised of shipping instructions when you call. Please include a brief description of the problem and a dated proof-of-purchase receipt with any product returned for warranty repair. Products returned to Seller for warranty repair, which upon receipt by Seller are confirmed to be defective and covered by this limited warranty, will be repaired or replaced (at Seller's sole option) at no cost to you and returned pre-paid. Parts will be repaired or replaced with new or factory-rebuilt parts at Seller's sole option.

**ALL IMPLIED WARRANTIES FOR THE PRODUCT, INCLUDING BUT NOT LIMITED TO ANY IMPLIED WARRANTIES OF MERCHANTABILITY AND FITNESS FOR A PARTICULAR PURPOSE, ARE LIMITED IN DURATION TO THE 5 YEAR COMMERCIAL LIMITED WARRANTY PERIOD SET FORTH ABOVE [EXCEPT THE IMPLIED WARRANTIES WITH RESPECT TO THE INSL24UL and IHSL24UL, WHICH ARE LIMITED IN DURATION TO THE 5 YEAR COMMERCIAL LIMITED WARRANTY PERIOD FOR THE INSL24UL and IHSL24UL, AND NO IMPLIED WARRANTIES WILL EXIST OR APPLY AFTER SUCH PERIOD. Some states do not allow limitations on how long an implied warranty lasts, so the above limitation may not apply to you. THIS LIMITED WARRANTY DOES NOT COVER DAMAGE CAUSED BY IMPROPER INSTALLATION, OPERATION OR CARE (INCLUDING, BUT NOT LIMITED TO ABUSE, MISUSE, FAILURE TO PROVIDE REASONABLE AND NECESSARY MAINTENANCE, UNAUTHORIZED REPAIRS OR ANY ALTERATIONS TO THIS PRODUCT), LABOR CHARGES FOR REINSTALLING A REPAIRED OR REPLACED UNIT, OR REPLACEMENT OF BATTERIES.**

**THIS LIMITED WARRANTY DOES NOT COVER ANY PROBLEMS WITH, OR RELATING TO, THE GATE OR GATE HARDWARE, INCLUDING BUT NOT LIMITED TO THE GATE SPRINGS, GATE ROLLERS, GATE ALIGNMENT OR HINGES. THIS LIMITED WARRANTY ALSO DOES NOT COVER ANY PROBLEMS CAUSED BY INTERFERENCE. ANY SERVICE CALL THAT DETERMINES THE PROBLEM HAS BEEN CAUSED BY ANY OF THESE ITEMS COULD RESULT IN A FEE TO YOU.**

**UNDER NO CIRCUMSTANCES SHALL SELLER BE LIABLE FOR CONSEQUENTIAL, INCIDENTAL OR SPECIAL DAMAGES ARISING IN CONNECTION WITH USE, OR INABILITY TO USE, THIS PRODUCT. IN NO EVENT SHALL SELLER'S LIABILITY FOR BREACH OF WARRANTY, BREACH OF CONTRACT, NEGLIGENCE OR STRICT LIABILITY EXCEED THE COST OF THE PRODUCT COVERED HEREBY. NO PERSON IS AUTHORIZED TO ASSUME FOR US ANY OTHER LIABILITY IN CONNECTION WITH THE SALE OF THIS PRODUCT.**

Some states do not allow the exclusion or limitation of consequential, incidental or special damages, so the above limitation or exclusion may not apply to you. This limited warranty gives you specific legal rights, and you may also have other rights which vary from state to state.

# APPENDIX

## SAMS Wiring with Relays Not Energized

### SAMS Operation

To keep vehicles from rushing the gate, the barrier arm stays in closed position until the gate reaches fully open position then the barrier arm is released to open and allow vehicles to pass.

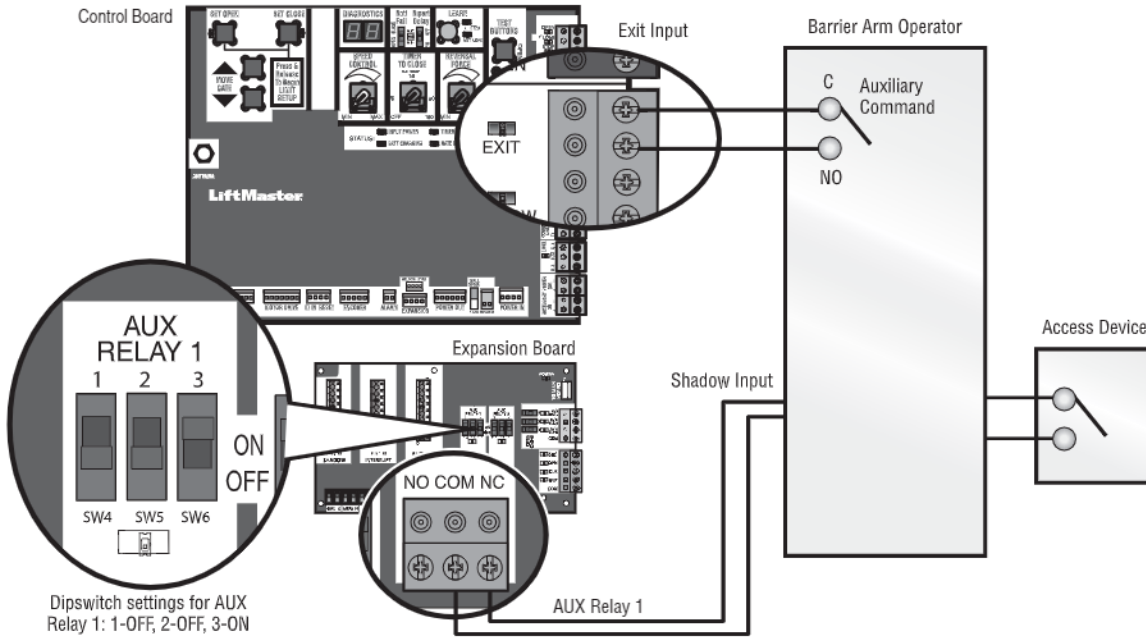

### Dual Gate Settings

**NOTE:** We recommend that all accessories, except entrapment protection devices, and board configurations are set on the primary operator.

#### Control board

FEATURE	PRIMARY OPERATOR	SECONDARY OPERATOR <small>page 22</small>
Timer-to-Close	Set the TTC dial to desired setting	OFF
Bi-Part Delay Switch	Synchronized Close: ON	Synchronized Close: ON
Speed	Set the speed control dial on each operator to the desired setting, see page 22 for more details	

#### Accessories

ACCESSORY	PRIMARY OPERATOR	SECONDARY OPERATOR
Remote Controls	Program remote controls 1 to 50 to the primary operator.	Program remote controls 51 to 100 to the secondary operator
LiftMaster Internet Gateway	Program to primary operator.	
Garage and Gate Monitor	Program to primary operator.	

#### Expansion board

FEATURE	PRIMARY OPERATOR	SECONDARY OPERATOR
QUICK CLOSE Switch	ON	OFF
ANTI-TAIL Switch	ON	OFF
LOW BATT Switch	Battery Fail OPEN: OPEN Battery Fail CLOSE: CLOSE	Battery Fail OPEN: OPEN Battery Fail CLOSE: CLOSE
AC FAIL OPEN/BATT Switch	OPEN	OPEN

## Manual Adjustments with a Remote Control

To set the limits using a remote control, first you will need a 3-button remote control that has been programmed for OPEN, CLOSE, and STOP. Refer to the *Programming* section.

### Initial Limits and Force Adjustment

For dual gate applications the limits will have to be set for each operator. The gate **MUST** be attached to the operator before setting the limits and force.

Ensure the gate is closed.

1. Press and release the SET OPEN and SET CLOSE buttons simultaneously to enter limit setting mode.
2. Press and hold the OPEN or CLOSE button on the remote control until the gate reaches the desired open position. The gate can be jogged back and forth using the OPEN and CLOSE buttons on the remote control.
3. Once the gate is in the desired open position, press and release the STOP button on the remote control.
4. Press and release the OPEN button on the remote control again to set the open limit.
5. Press and hold the CLOSE or OPEN button on the remote control until the gate reaches the desired close position. The gate can be jogged back and forth using the OPEN and CLOSE buttons on the remote control.
6. Once the gate is in the desired close position, press and release the STOP button on the remote control.
7. Press and release the CLOSE button on the remote control again to set the close limit.
8. Cycle the gate open and close. This automatically sets the force.

When limits are set properly the operator will automatically exit limit setting mode.

Refer to the *Adjustment* section and follow the instructions for *Speed Control*, *Fine Tune the Force*, and *Obstruction Test*.

### Adjust the limits

If the limits have already been set the operator will exit the limit setting mode after resetting each limit.

#### Set the Close Limit Only

1. Press and release the SET OPEN and SET CLOSE buttons simultaneously to enter limit setting mode.
2. Press and hold the CLOSE button on the remote control until the gate reaches the desired close position. The gate can be jogged back and forth using the OPEN and CLOSE buttons on the remote control.
3. Once the gate is in the desired close position, press and release the STOP button on the remote control.
4. Press and release the CLOSE button on the remote control again to set the close limit.

When the close limit is set properly the operator will automatically exit limit setting mode.

#### Set the Open Limit Only

1. Press and release the SET OPEN and SET CLOSE buttons simultaneously to enter limit setting mode.
2. Press and hold the OPEN button on the remote control until the gate reaches the desired open position. The gate can be jogged back and forth using the OPEN and CLOSE buttons on the remote control.
3. Once the gate is in the desired open position, press and release the STOP button on the remote control.
4. Press and release the OPEN button on the remote control again to set the open limit.

When the open limit is set properly the operator will automatically exit limit setting mode.

Perform the obstruction test after every limit, speed, and force setting adjustment see page 23.

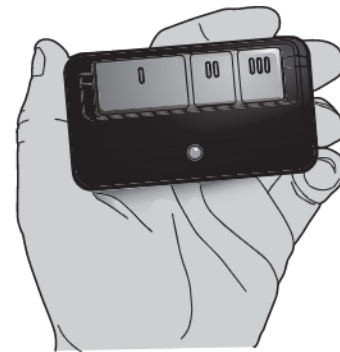
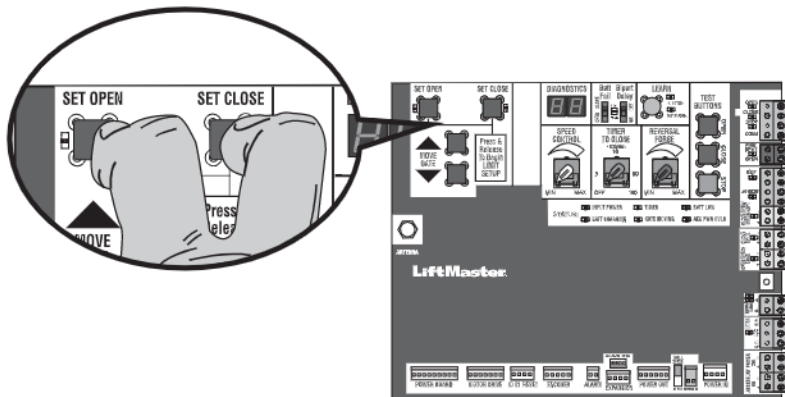

3-Button Remote Control programmed for OPEN, CLOSE, and STOP

# APPENDIX

## Wiring Diagram

### WARNING

To protect against fire and electrocution:

- DISCONNECT power (AC or solar and battery) BEFORE installing or servicing operator.

For continued protection against fire:

- Replace ONLY with fuse of same type and rating.

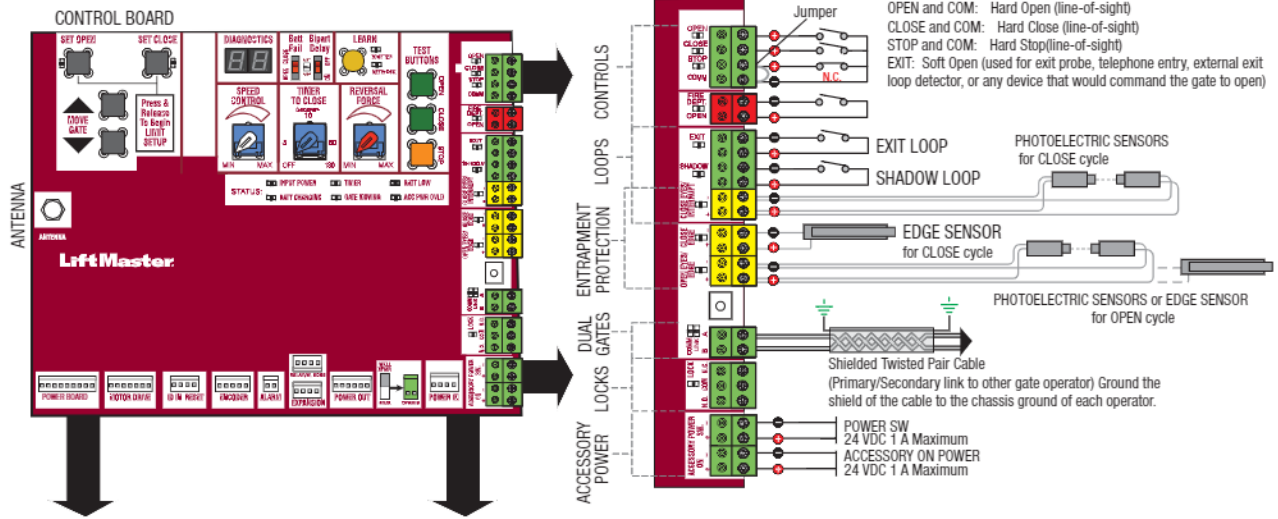

# APPENDIX

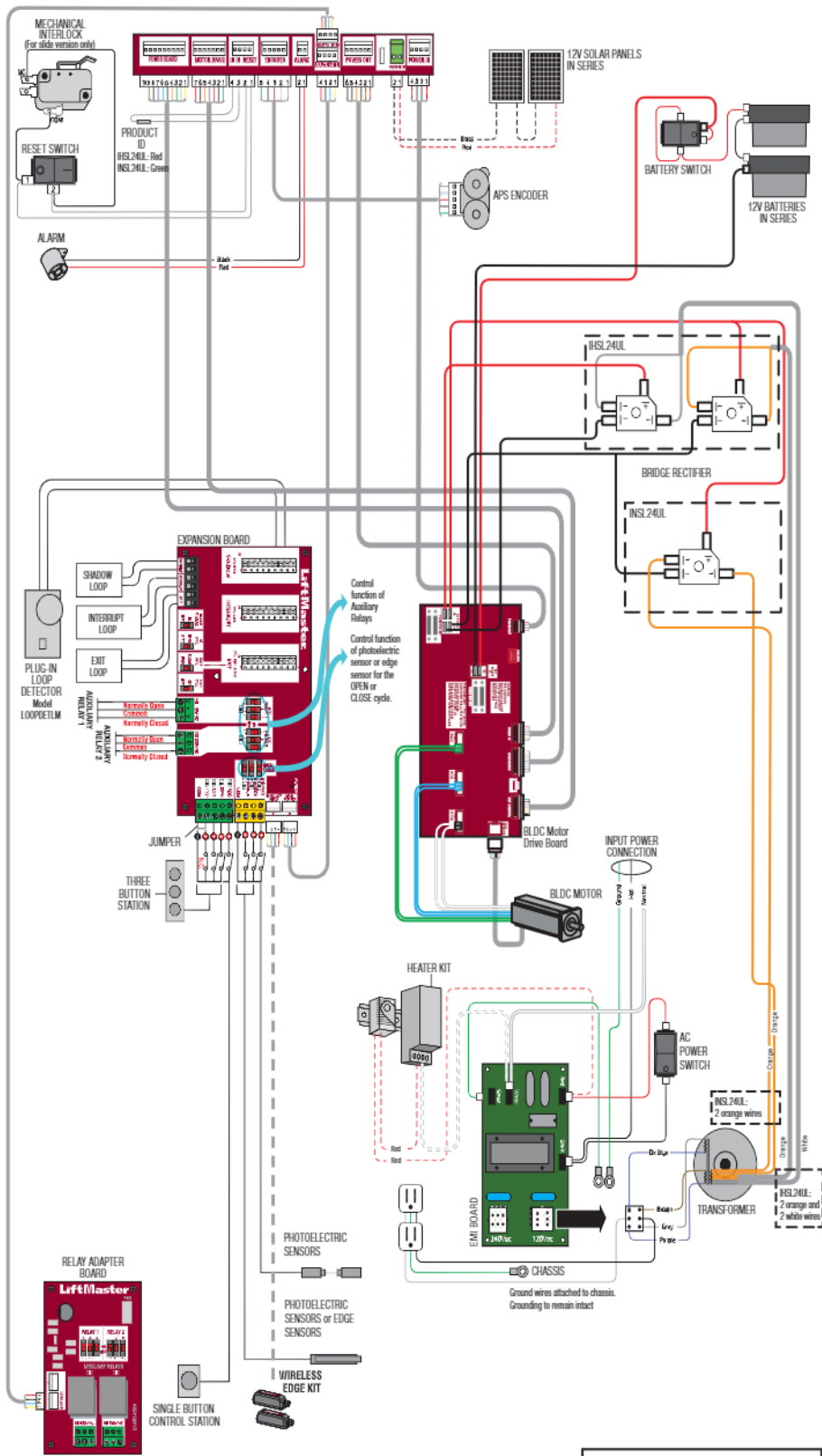

**Note**  
 Use Copper Conductors Only  
 N'utilisez que des conducteurs en cuivre

# APPENDIX

## Diagnostic Codes Table

Some codes are saved in the code history and some are not. If a code is not saved it will briefly appear on the display as it occurs, then disappear.

 LiftMaster System	 Installed System	 Informational	 External Entrapment Protection	 Inherent Entrapment Protection
--	--	---	---	--

Code	Meaning	Solution	Saved
31	Control board has experienced an internal failure.	Disconnect all power, wait 15 seconds, then reconnect power (reboot). If issue continues, replace control board.	NO
34	Absolute Position Encoder error, not getting position information from encoder	Check APE assembly and wiring connections. Replace the APE assembly if necessary.	YES
35	Max-run-time exceeded error	Check for an obstruction, then reprogram the limits.	YES
36	Product ID error	Was the control board just replaced? If so, erase limits, enter limit setup mode and set limits. If not, disconnect all power, wait 15 seconds, then reconnect power before changing product ID harness.	YES
37	Product ID failure	Unplug product ID harness then plug back in. Disconnect all power, wait 15 seconds, then reconnect power before replacing product ID harness.	YES
38	Hard stop limit (Arm 1)	Limit may be set too tightly against a non-resilient hard stop (re-adjust limit). Operator may be at end of travel (re-adjust mounting).	NO
40	Battery overvoltage	Too much voltage on the battery. Check harness.	YES
41	Battery overcurrent	Possible short of the battery charge harness. Check harness. Make sure you do NOT have a 12V battery on a 24V system.	YES
42	No battery at boot up	Check battery connections and installation. Replace batteries if depleted to less than 20V on a 24V system. Make sure there is NOT a single 12V battery on a 24V system.	YES
43	Exit loop error	Failure or missing loop (SHORT or OPEN - LiftMaster Plug-in Loop Detector only). Check loop wiring throughout connection. May be a short in the loop, or an open connection in the loop.	YES
44	Shadow loop error		
45	Interrupt loop error		
46	Wireless edge battery low	Replace batteries in wireless edge.	YES
47	Motor Drive Fault	Check motor drive connections. Disconnect all power, wait 15 seconds, then reconnect power (reboot). If issue persists, replace motor drive board.	YES
48	Hall Sensor Fault	Check motor and motor drive connections. Disconnect all power, wait 15 seconds, then reconnect power (reboot). If issue persists, replace motor.	YES
49	Motor Drive Communications Fault	Verify drive board power and connection to control board. Disconnect all power, wait 15 seconds, then reconnect power (reboot). If issue continues, replace motor drive	YES
50	Gate overspeed detected	Make sure the gate is installed on a level surface and not on an excessive grade.	YES
53	Brownout occurred	AC/DC board supply dipped below allowable level. Review power supply and wiring. If rebooting, ensure enough time for discharge of power to force a fresh boot.	YES
54	Wireless second operator communication error	Check the second operator for power. If OFF, restore power and try to run the system. If powered, deactivate the wireless feature and then re-learn the second operator.	YES
59	Configuration error with Motor, Drive Board, or ID Resistor	Check connections between motor, motor drive, and control board. Confirm correct part has been replaced, disconnect all power, wait 15 seconds, then reconnect power (reboot). If issue persists, remove and replace latest part that was changed.	YES
60	Minimum number of monitored entrapment protection devices not installed.	Review monitored entrapment protection device connections. See page 12 for minimum requirements.	NO

## APPENDIX

Code	Meaning	Solution	Saved
61	CLOSE EYE/INTERRUPT held	Check wired input on control board; check for alignment or obstruction; squeeze and release the edge and verify main board edge LED changes; check for eye alignment or obstruction.	YES
62	CLOSE EDGE held		
63	OPEN EYE/EDGE held		
64	CLOSE EYE/INTERRUPT held	Check wired input on expansion board; check for alignment or obstruction; squeeze and release the edge and verify main board edge LED changes; check for eye alignment or obstruction.	YES
65	CLOSE EYE/EDGE held		
66	OPEN EYE/EDGE held		
67	Wireless edge triggered extended time	Check wired input for wiring issue or obstruction; squeeze and release the edge and verify main board edge LED changes	YES
68	Wireless edge loss of monitoring	Check wireless edge inputs.	YES
69	Wireless edge triggered	IF an obstruction occurred, no action required. If an obstruction did NOT occur, check inputs and wiring.	NO
70	CLOSE EYE/INTERRUPT triggered, causing reversal, preventing close, or resetting TTC	IF an obstruction occurred, no action required. If an obstruction did NOT occur, check alignment, inputs, and wiring on control board	NO
71	CLOSE EDGE triggered, causing reversal, preventing close, or canceling TTC		
72	OPEN EYE/EDGE triggered, causing reversal or preventing opening		
73	CLOSE EYE/INTERRUPT triggered, causing reversal, preventing close, or resetting TTC	IF an obstruction occurred, no action required. If an obstruction did NOT occur, check alignment, inputs, and wiring on expansion board.	NO
74	CLOSE EYE/EDGE triggered, causing reversal and preventing close or canceling TTC		
75	OPEN EYE/EDGE triggered, causing reversal or preventing opening		
80	Close input (EYE/EDGE) communication fault from other operator	Check inputs and communication method between operators, either wired bus or radio. Ensure operator is powered. May have to erase the wireless communication and reprogram the two operators.	YES
81	Open input (EYE/EDGE) communication fault from other operator		
82	Close input (EYE/EDGE) communication fault (expansion board)	Check the connections between the control board and the expansion board.	YES
83	Open input (EYE/EDGE) communication fault (expansion board)		
84	Non-monitored device detected on the wireless safety system	Non-monitored contact closure devices are not supported. Make sure connected devices are monitored. Check edges for proper orientation and resistive end cap connection.	YES
90	Low Voltage Input to Motor Drive Fault	Verify incoming power meets voltage requirement of operator. Verify battery voltage is above 20V. Disconnect all power, wait 15 seconds, then reconnect power (reboot). If issue persists, replace power supply.	YES
91	Force reversal	Check for obstruction. If no obstruction, check that the mechanical assembly is engaged and free to move. See <i>Adjust the Limits, Speed, and Force</i> page 21.	YES
93	RPM / STALL reversal	Check for obstruction. If no obstruction, check the operator wiring and that the mechanical assembly is engaged and free to move. Replace APE assembly.	YES
95	Motor start failure	Operator attempted to run, no response from motor drive assembly. Check connector and harness. Check for other error codes and resolve those first. If connected properly and still not working, test motor and/or motor drive.	YES
96	Motor Drive Board Fault	Check connections to motor drive board. Power cycle and retry. Replace motor drive board if issue persists.	YES
99	Normal operation	No action required	YES





# Swing and Slide Gate Operator UL 325 and ASTM F2200 Site Planning Safety Checklist

Please Print

Name: \_\_\_\_\_ Phone: \_\_\_\_\_

Address: \_\_\_\_\_

City/State/ZIP: \_\_\_\_\_ Email: \_\_\_\_\_

Satisfactory	Needs Repair/Replacement
--------------	--------------------------

## Gate Safety Check — Simple steps to quickly determine if an End User's gate operator is safe.

UL 325 Standard				Result (Circle)	Comments:	Figures (On Back)
Component:						
1. Gate Operator is approved to current UL 325 standards (check operator label)				Pass / Fail		
2. Proper gate warning signs attached to both sides of gate area				Pass / Fail		1,4
3. All entrapment zones protected by 2 safety devices/obstruction tested						1,4
Close Side (circle two)	Photo Eye	Reversing Edge	Inherent Reverse	Pass / Fail		
Open Side (circle two)	Photo Eye	Reversing Edge	Inherent Reverse	Pass / Fail		
Other Entrapment Zones				Pass / Fail		
*Entrapment Zone: The location where a person can be caught or held in a position that increases the risk of injury						

Gate Construction Evaluation: Gate Constructed with Safety in mind. ASTM F2200 Standards are followed

Component:	Result (Circle)	Comments:	Figures (On Back)
<b>All Gates</b>			
Gates have smooth bottom edges, no protrusions exceed 1/2" beyond base of gate	Pass / Fail		5
All access controls at least 6 ft. from gate	Pass / Fail		1,4
Barbed tape (razor wire) at least 8 ft. above grade	Pass / Fail		
Barbed wire at least 6 ft. above grade	Pass / Fail		
Separate pedestrian gate – out of reach of a moving gate – vehicular gate is for automotive traffic only	Pass / Fail		1,4
Gate does not move on its own if disconnected from operator	Pass / Fail		
Gates prevented from falling over if disconnected from supporting hardware	Pass / Fail		

<b>SWING</b>			
Distance from pivot point to column edge is less than 4 in. or external entrapment protection is provided	Pass / Fail		4
Distance from open gate to wall, column, or other fixed object is greater than 16 in. or external entrapment protection is provided	Pass / Fail		4

<b>SLIDE</b>			
Roller covers on weight bearing exposed rollers 8 ft., or less, above grade	Pass / Fail		1
Meshing installed up to 6 ft. above grade if pickets spaced equal to or greater than 2 1/4 in. apart	Pass / Fail		3
Gap between gate and fence post less than 2 1/4 in. & gap protected with safety device	Pass / Fail		2
Positive stops at both fully open and fully closed positions	Pass / Fail		1
Receiver guides recessed behind receiver post for receiver guides less than 8 ft.	Pass / Fail		
Other:	Pass / Fail		

Please Print

First & Last Name of Dealer: \_\_\_\_\_ First & Last Name of Installer: \_\_\_\_\_

Name of Dealership: \_\_\_\_\_ Phone: \_\_\_\_\_

Dealership Address (Street Address/City/State/Zip): \_\_\_\_\_

Dealer Signature: \_\_\_\_\_ Installer Signature: \_\_\_\_\_

Customer Signature: \_\_\_\_\_





## **Contact Information**

### **LiftMaster.com**

LiftMaster Partner Portal:

**Partner.LiftMaster.com/login**

LiftMaster Training Academy:

**LiftMasterTraining.com**

800-528-2806

Mon-Fri 5:00 am to 6:00 pm MST

300 Windsor Drive  
Oak Brook, IL 60523  
**LiftMaster.com**

© 2022, The Chamberlain Group LLC. - All Rights Reserved

114-5573-000C