

INSTALLATION & MAINTENANCE GUIDE

R7S HID & 12IN PENDANT LIGHT FIXTURES

Item #	Product Description
420205	R7S HID 36IN
420206	R7S HID 48IN
420207	R7S HID 72IN
420208	Light Pendant 12IN

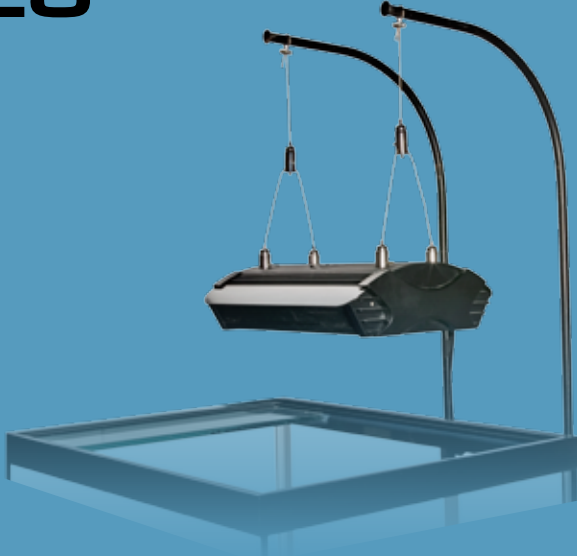

TABLE OF CONTENTS



This symbol indicates “WARNINGS” that are essential in order to protect against injury to people or damage to equipment.



This symbol indicates “NOTES” that are specific instructions on how to operate, control, adjust or maintain the units.



This symbol indicates “TIPS” that are intended to offer helpful advice for a better user experience.

Safety Instructions.....	3
Warnings	3
Grounding	3

R7S HID / T5 Combination Light Fixture

Identify Parts.....	4
Parts Diagram.....	4
Parts & Specifications	4
Installation	5
Packaging	5
T5 HO Lamps.....	5
Suspension Hardware.....	6
Aquarium Frame Mounts ..	6
Power	7
Timer	7
Operation	
Timer Set-up & Operation .	7
Maintenance	9
Housing	9
Lens Covers.....	9
T5 HO Lamp Replacement..	9
HID Lamp Replacement.....	9

12in Pendant R7S HID Light Fixture

Identify Parts.....	10
Parts Diagram.....	10
Replacement Parts.....	10
Product Specifications ..	10
Suspension Hardware... ..	10
Installation	11
Assembly	11
Suspension Assembly.....	12
J Hook	12
Ceiling Mount	12
Fixture Attachment.....	12
Ballast Installation.....	14

Glossary of Terms	15
Registration & Warranty ..	16

Thank you for purchasing an AquaticLife™ High Intensity Discharge (HID) Light Fixture for use with your aquarium!

We know you value quality and innovation and will be pleased with this product’s performance.

We encourage you to take a few minutes to become familiar with this manual and note items that apply to your particular model. For additional information, please visit www.aquaticlife.com.

Your purchase includes a coupon on the side of the box. Save Life Rewards™ point coupons from Aquatic Life products and redeem them for free merchandise at www.aquaticlife.com. This is our way of saying thank you for your loyalty.



Copyright © Aquatic Life, LLC
All rights reserved.

No part of this document may be reproduced, stored in a retrieval system, or transmitted in any form or by any means without the prior written consent of Aquatic Life, LLC.

Aquatic Life, LLC
Commerce, CA 90040
Toll-Free US only: (888) 548-3480
Outside the US: 1-818-768-6943
customersupport@aquaticlife.com

Check us out on...



SAFETY INSTRUCTIONS



WARNING

TO GUARD AGAINST INJURY, BASIC PRECAUTIONS SHOULD BE OBSERVED, INCLUDING THE FOLLOWING:

- A) **READ AND FOLLOW ALL SAFETY INSTRUCTIONS.**
- B) **DANGER** – To avoid possible electric shock, special care should be taken since water is employed in the use of aquarium equipment. For each of the following situations, do not attempt repairs by yourself; return the appliance to an authorized service facility for service or discard the appliance:
 - 1) If the appliance falls into the water, DON'T reach for it! First unplug it and then retrieve it. If electrical components of the appliance get wet, unplug the appliance immediately. (Non-immersible equipment only)
 - 2) If the appliance shows any sign of abnormal water leakage, immediately unplug it from the power source. (Immersible equipment only)
 - 3) Carefully examine the appliance after installation. It should not be plugged in if there is water on parts not intended to be wet.
 - 4) Do not operate any appliance if it has a damaged cord or plug, or if it is malfunctioning or has been dropped or damaged in any manner.
 - 5) To avoid the possibility of the appliance plug or receptacle getting wet, position aquarium stand and tank to one side of a wall-mounted receptacle to prevent water from dripping onto the receptacle or plug. A "drip loop," shown in the figure below, should be arranged by the user for each cord connecting an aquarium appliance to a receptacle. The "drip loop" is that part of the cord below the level of the receptacle, or the connector if an extension cord is used, to prevent water traveling along the cord and coming in contact with the receptacle. If the plug or receptacle does get wet, DON'T unplug the cord. Disconnect the fuse or circuit breaker that supplies power to the appliance. Then, unplug and examine for presence of water in the receptacle.
- C) Close supervision is necessary when any appliance is used by or near children.
- D) To avoid injury, do not contact moving parts or hot parts such as heaters, reflectors, lamp bulbs, and the like.
- E) Always unplug an appliance from an outlet when not in use, before putting on or taking off parts, and before cleaning. Never yank cord to pull plug from outlet. Grasp the plug and pull to disconnect.
- F) Do not use an appliance for other than intended use. The use of attachments not recommended or sold by the appliance manufacturer may cause an unsafe condition.
- G) Do not install or store the appliance where it will be exposed to the weather or to temperatures below freezing.
- H) Make sure an appliance mounted on a tank is securely installed before operating it.
- I) Read and observe all the important notices on the appliance.
- J) If an extension cord is necessary, a cord with a proper rating should be used. A cord rated for less amperes or watts than the appliance rating may overheat. Care should be taken to arrange the cord so that it will not be tripped over or pulled.
- K) For added safety, the appliance must be plugged into a receptacle controlled by a GFCI (ground fault interrupter) circuit breaker. Device must be properly connected to a grounded three-prong receptacle.
- L) This appliance is intended FOR HOUSEHOLD USE ONLY.
- M) This Light Fixture is required to be used over a covered aquarium. A glass top or protective barrier is required to minimize the fixture's exposure to water.
- N) **SAVE THESE INSTRUCTIONS**



NOTE

DO NOT POSITION HID LAMPS DIRECTLY OVER AQUARIUM FRAME BRACES

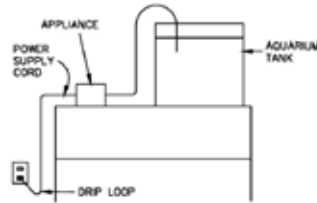

GROUNDING INSTRUCTIONS

THIS APPLIANCE SHOULD BE GROUNDED TO MINIMIZE THE POSSIBILITY OF ELECTRIC SHOCK.

GROUNDING SETUP

This appliance should be grounded to minimize the possibility of electric shock. This appliance is equipped with an electric cord having an equipment grounding conductor and a grounding type plug. The plug must be plugged into an outlet that is installed and grounded in accordance with all appropriate codes and ordinances.

This appliance is for use on a normal 120-volt circuit, and has a grounding plug that looks like the plug illustrated below.

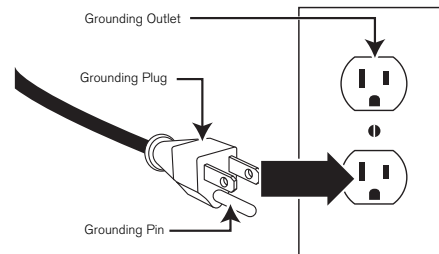

A temporary adaptor which looks like the adaptor illustrated in (A) may be used to connect this plug to a two-pole receptacle as shown in (A) if a grounded outlet is not available.

A temporary adaptor should only be used until a grounded outlet can be installed by a qualified electrician.

GROUNDING INSTALLATION

The green-colored rigid tab extending from the adaptor must be fastened to a permanent ground such as a grounded outlet box.

1. Plug temporary adaptor into two-pole outlet. (B)
2. Insert screw through rigid tab on temporary adaptor and into grounded outlet box. (C)

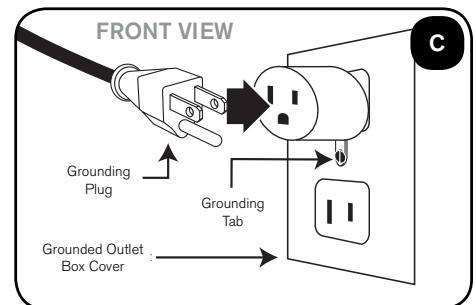
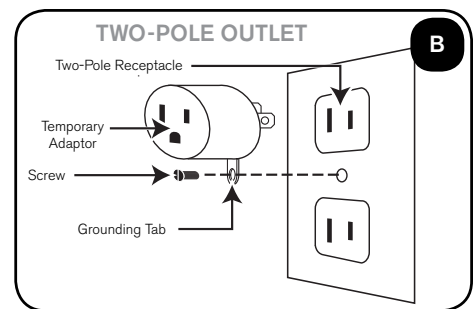
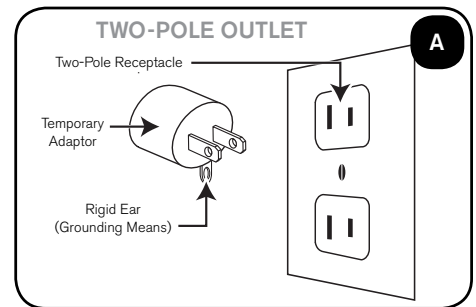

PARTS DIAGRAM

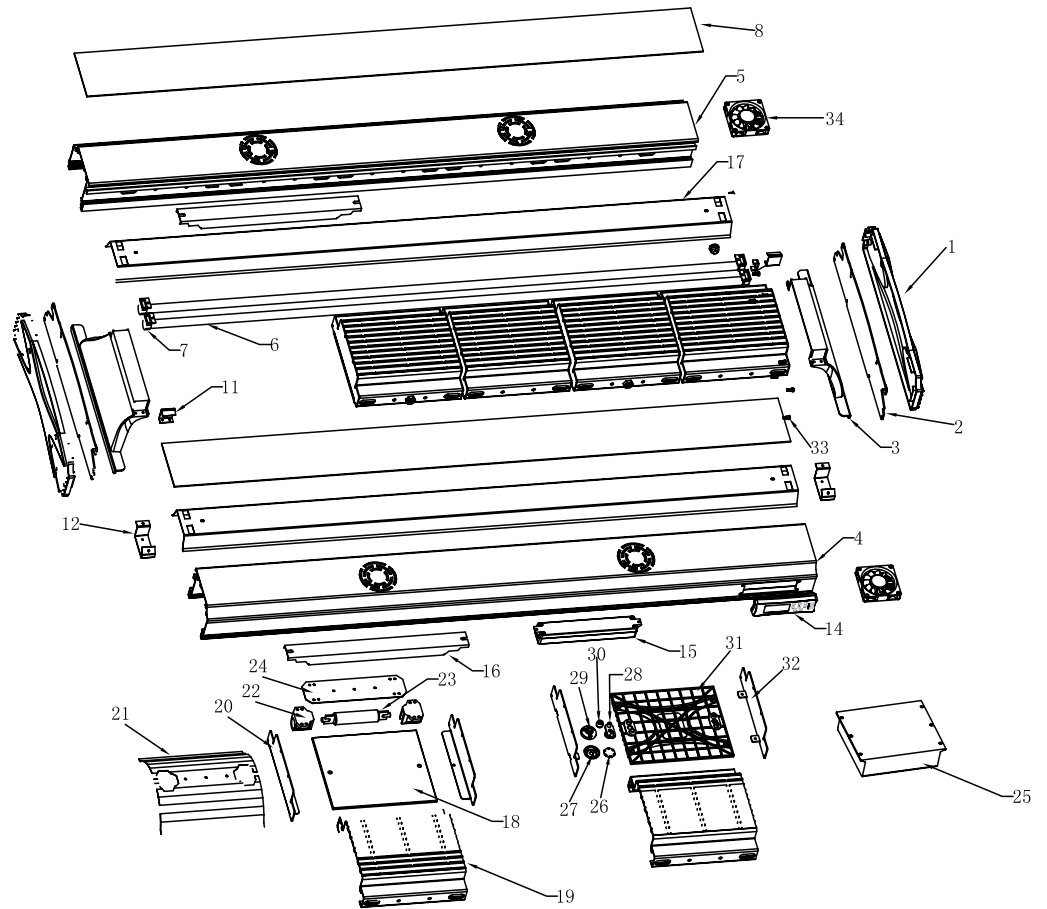

PARTS LIST & SPECIFICATIONS: R7S HID Light Fixtures

	Model Numbers		
	(36in) 420205	(48in) 420206	(72in) 420207
420/460 Lamp(s):	410041	410043	410041
HID Lamp(s):	410202 (10K), 410203 (14K), 410204 (20K)		
LED:	470009	470109	470109
Aquarium Frame mounts:	470064		
Suspension Hardware:	420063		
Ballast (HID):	470108		
Ballast (T5HO):	470071	470072	470071
Lens Cover:	✓	✓	✓
End Plate:	470110		
Installation & Maintenance Guide:	✓		
Rated Voltage:	120 Volt AC		
Rated Cycle:	60Hz		
Power Factor (HID):	0.99	0.99	0.99
Power Factor (T5 HO):	0.55	0.59	0.55
Power Cord Length:	3 meters		
Dimensions without Frame Mounts: (L x W x H):	91 x 39 x 15.8 cm 35.8 x 15.4 x 6.2 in	121 x 39 x 15.8 cm 47.6 x 15.4 x 6.2 in	181 x 39 x 15.8 cm 71.3 x 15.4 x 6.2 in

B7S HID INSTALLATION

Tools required for installation:

- 1) Phillips #2 Screwdriver
- 2) Allen Wrench (included)



TIP: Use a large towel under the fixture while removing the shipping materials to avoid scratching the fixture.



NOTE: The Allen Wrench supplied with the fixture is conveniently stored in the bag with the CD Manual.

PACKAGING

The Aquatic Life Marine Light Fixture is shipped with the HID lamp(s) NOT installed. The T5 HO lamps will need to have the packaging materials removed prior to operation. Place the light fixture upside down on a surface that will not mar or scratch the finish.

- 1) Remove the four Allen screws (indicated in the illustration) from the left and right sides of the End Plate (Allen Wrench Included)

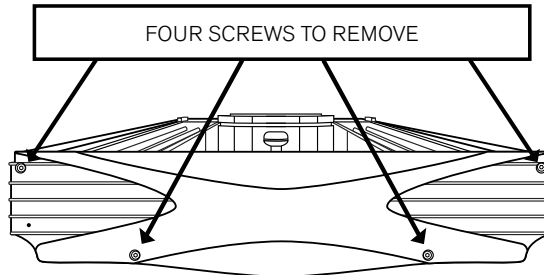

- 2) With the four screws removed, pull the End Plate from the fixture.

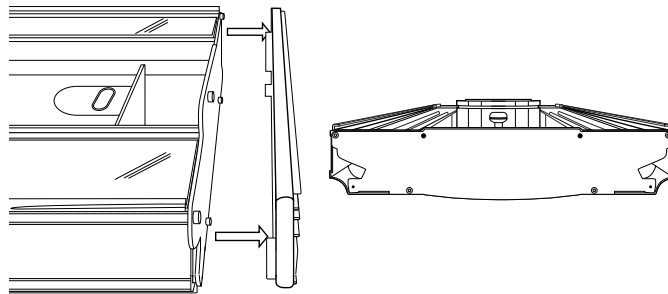

- 3) Slide the two Acrylic Lens Covers out of the fixture.

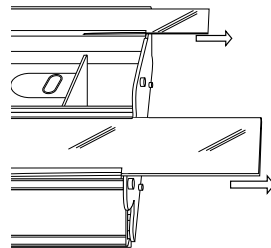

T5 HO LAMPS

- 1) Remove the shipping tube from around the T5 HO Lamps.
- 2) Insert the T5 Lamps into the sockets of the fixture and rotate into place.

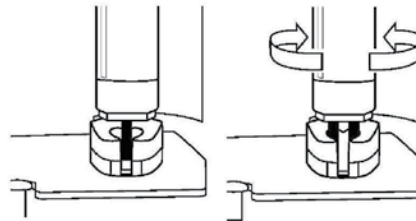

- 3) Acrylic scratches easily and your new fixture includes a plastic film on the Lens Cover to protect it during shipping. Peel the protective film off both sides of the Acrylic Lens Cover.



NOTE: DO NOT replace the end plates until the Aquarium Frame Mounts have been attached.

SUSPENSION HARDWARE (Contact your Aquatic Life Retailer for Optional Hardware)

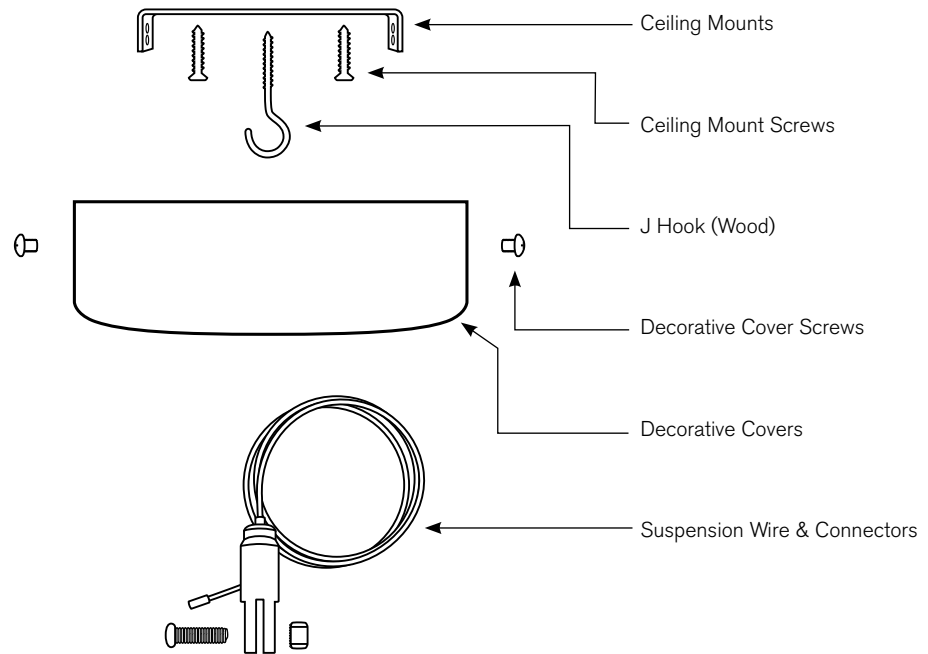

AQUARIUM FRAME MOUNTS



WARNING: To install the Aquarium Frame Mounts, the outer plastic End Plate is removed and then the inner metal End Plate is removed. ONLY REMOVE THE PLASTIC AND METAL END PLATES FROM ONE SIDE OF THE FIXTURE AT A TIME. Removing the End Plates from both sides of the fixture at the same time will cause the fixture to separate.

- 1) With one outer plastic End Plate removed, remove the inner metal End Plate by removing the four screws.

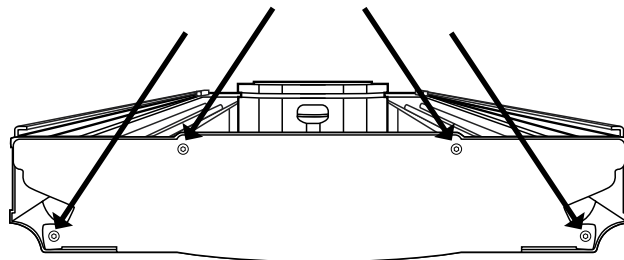

- 2) Slide the Aquarium Frame Mount into the bottom channel of the light fixture.

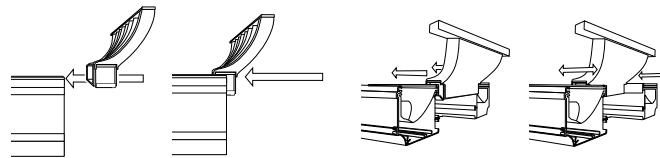

NOTE: Before reattaching the second plastic End Plate, slide the Acrylic Lens Covers back into the track over the T5 HO lamps.

- 3) Reattach the inner metal End Plate with the eight screws.
- 4) Reattach the outer plastic End Plate. Repeat steps 1 through 5 to the other end of the light fixture to install the second Aquarium Frame Mount.
- 5) Place the fixture over the aquarium and adjust (slide) the Aquarium Frame Mounts so that the base of each Mount is firmly resting on the aquarium frame. Tighten the screws on the underside of the Mounts to secure in place above the aquarium.

NOTE:
REMOVE
PROTECTIVE
FILM

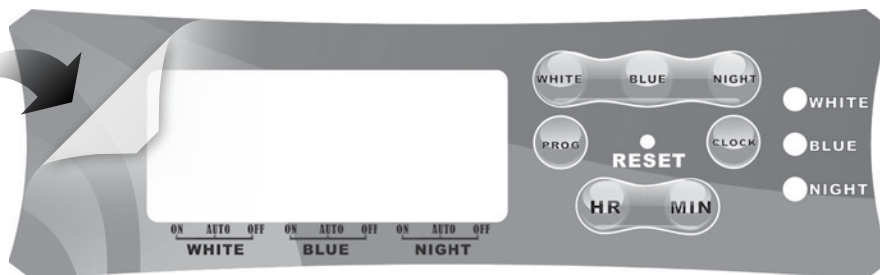

RESET BUTTON:

If the fixture is powered off or unplugged without turning the lamps off manually at the timer, the timer may “lock” and not have any display.

To reset the timer to its pre-programmed settings, press the Reset Button in the middle of the Timer Panel. A paper clip or similar small object will be needed to press the Reset Button.

POWER

Your Aquatic Life Light Fixture is equipped with a built in Digital Timer and a single power cord. The Timer enables independent control of the three lighting zones in the fixture. Connect the power cord into a grounded outlet (GFCI). The display will illuminate when power is supplied.

TIMER

The Digital Timer controls three Zones in the Light Fixture: WHITE, BLUE, NIGHT. Each of these Zones can be programmed to operate at different times throughout the day.

TIMER SET-UP

Setting the Time

- 1) Press CLOCK on the Control Panel until the time begins to flash. Press the HR and MIN buttons to scroll to the current time. Press CLOCK when current time is set.
- 2) The clock is equipped with a quick summer time mode that forwards the clock ahead one hour for Daylight Savings Time. Press both the HR and MIN at the same time and the clock will advance one hour and display S in the top right corner of the display. To change back to standard time, repeat the step above and the time will revert back one hour. The S on the display will disappear.

Zone Programming: Setting the on/off times for the Lamps to operate.

- 1) Simultaneously press both the “PROG” button and the button of the Zone Lamp type that you want to set at the same time (WHITE, BLUE or NIGHT). Three arrows above the Zone that is being programmed will begin to flash. START will appear on the display.
- 2) Press the HR and MIN buttons to adjust the START time.
- 3) Press PROG to scroll to the END time.
NOTE: For ease of programming, the clock displays a 24 hour format instead of AM or PM.
- 4) Press the HR and MIN buttons to adjust the END time. This is the time the Zone will power off.
- 5) Press CLOCK to return to the current time. The current time will automatically display if there is no activity for 60 seconds.
- 6) Repeat steps 1 through 5 for each Lamp type (Zone) that requires a new time of operation.

Pre-Programmed Times of Operation:

For ease of use, the timer is pre-programmed with START and END times. If the timer is in the Pre-programmed mode the display will show an R in the right hand corner of the display.

Zone 1	WHITE	START 9:00 - END 17:00
Zone 2	BLUE	START 8:00 - END 20:00
Zone 3	NIGHT	START 20:00- END 6:00

Manual Override

To override the timer during normal operation, press the button of the desired Zone. Press the button until the display triangle appears above the ON or OFF of the Zone selected.

To return to the AUTO mode, press the desired Zone button until the display triangle appears above AUTO.



NOTE: For ease of programming, the clock displays a 24 hour format instead of AM or PM.



NOTE: When the programmed on/off times are activated, a triangle indicator will appear on the digital display above AUTO. Press the button of the Lamp type to toggle between the ON / AUTO / OFF modes.



To view a video demonstration
on the Digital Timer go to
www.youtube.com/AquaticLifeLLC

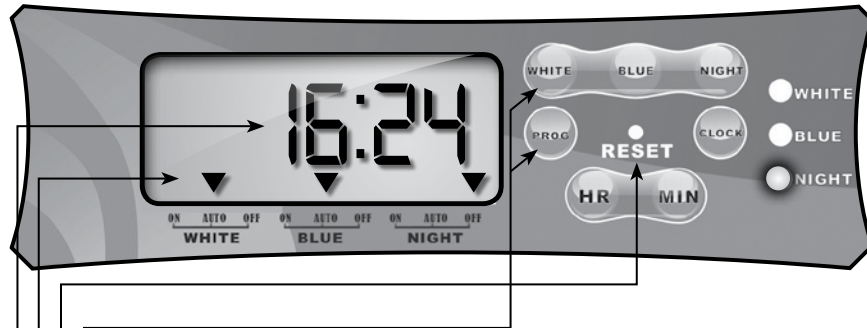

- Simultaneously press *PROG* and zone button to initiate programming mode
- Press *RESET* button to restore to factory presets
- Three arrows above *ON*, *AUTO*, *OFF* in the same zone indicate zone is being programmed
- Clock and Timer use a 24 hour format. (This display is currently showing 4:24 PM)
- Press *PROG* to cycle through current settings

Q: WHY DO THE LAMPS NOT TURN ON?

Verify the timer control is either in AUTO or ON mode. If the timer is in AUTO mode, make sure the time is programmed correctly

Q: WHY DO THE LAMPS TURN ON AT THE WRONG TIME?

The clock and timer use a 24 hour time format (Military Time). For example, 1:00 PM will show 13:00 on the display. Verify that the correct START/END times are set according to the 24 hour format.

Q: WHY IS THE TIMER NOT RESPONSIVE OR HAS NO DISPLAY?

If the light fixture was unplugged or encountered a power loss for an extended period of time, the timer might need to be reset. There is a small reset button on the front of the timer panel. Use the end of an ink pen or paper clip to press the small reset button. This will restore the light fixture to factory settings.

NEED ASSISTANCE?

Before contacting Aquatic Life, did you press the RESET button on the timer?

Aquatic Life Customer Support
1-888-548-3480 (USA Toll-Free)
1-818-768-6943
Monday – Friday, 8 am to 4 pm (PST)

Q: WHY CAN THE TIMER NOT BE PROGRAMMED?

The PROG and zone (WHITE, BLUE, NIGHT) buttons must be pressed at the same time to initiate the programming mode. When in the program mode, three arrows will be displayed pointing to the zone being programmed.

Q: WHY DO THE LAMPS FLASH, BUT DO NOT STAY ON?

Verify the lamps are in the sockets properly and the lamps are not broken or damaged.



WARNING: The fixture is not waterproof. Do not spray or submerge the fixture.



WARNING: the HID Glass Lens Cover will become extremely hot and requires 30 minutes to cool prior to cleaning.



TIP: Keep the fixture's Acrylic Lens Covers and Glass Covers clean to allow maximum light penetration into the aquarium.



TIP: To avoid scratching the fixture, place a large towel under the fixture prior to servicing.



WARNING: The fixture is hot during operation and must cool before servicing. Unplug the fixture from power supply and allow cooling for 30 minutes before changing HID lamps.



NOTE: Always handle HID Lamps with a cloth.

HOUSING

Unplug the Marine Light Fixture and wipe the housing with a clean moist/semi-dry cloth to remove dust, salt and other debris that may have built up on the fixture.

LENS COVERS

Wipe the T5 HO Acrylic Lens Cover with fresh water or an acrylic cleaner to maintain peak light transmission. If the Lens Cover is allowed to become dirty, it will reduce the amount of light that enters the aquarium.

Wipe the HID Glass Lens Cover with fresh water or vinegar to maintain peak light transmission.

T5 HO LAMP REPLACEMENT

Depending on the type of marine aquarium inhabitants, the Lamps may need to be replaced every 9 to 18 months. It is best to review the requirements for your animals prior to replacing the Lamps. Consult your local store or supplier for a recommendation for frequency of replacement.

To remove and replace T5 HO Lamps, follow the Installation procedure for Lamps on page 5. The instructions will show how to remove the End Plates and Lens Cover. This will give access to the T5 HO lamps.

HID LAMP INSTALLATION/REPLACEMENT

- 1) Place the light fixture upside down on a surface that will not mar or scratch the finish.
- 2) Remove the two screws around the glass Frame of the HID Housing.

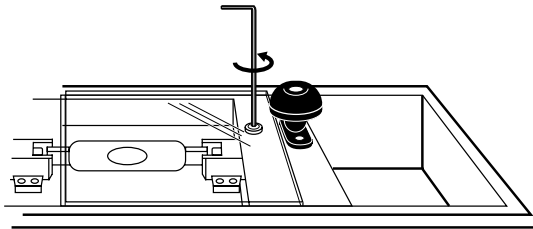

- 3) Lift the Glass off of the HID Housing.

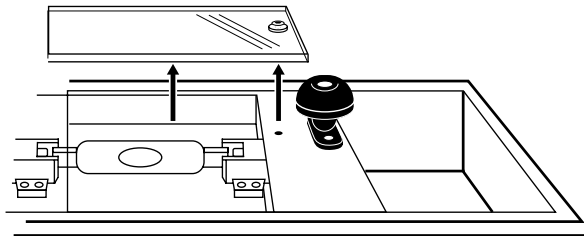

- 4) Grasp the Lamp at one side and gently press the opposite end against the spring loaded socket. As the Lamp depresses into the spring, the Lamp will position itself to insert into the other socket.

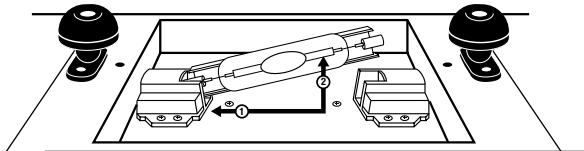

- 5) Insert the new Lamp into the socket.

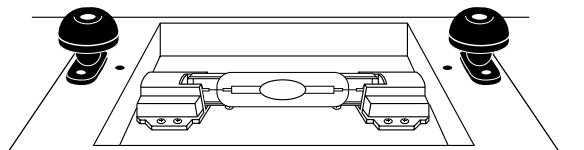

- 6) Replace the glass Lens Cover.

12IN PENDANT PARTS / SPECS

PARTS DIAGRAM

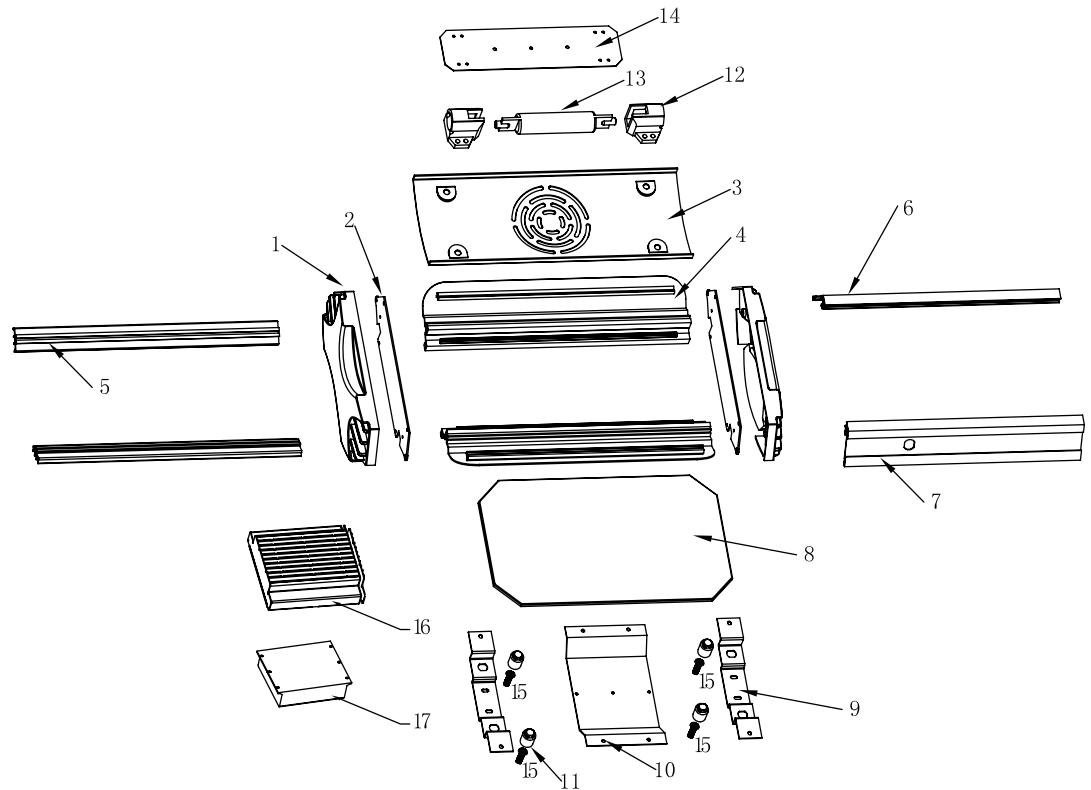

PARTS LIST: For 12" Pendant

	Model Number
	420208
R7S DE HID 10K Lamp:	410053
Ballast (HID):	470108
Lens Cover (Glass):	470015
End Plates:	470111
Installation & Maintenance Guide:	✓
Suspension Hardware	420063

SPECIFICATIONS: For 12" Pendant

	Model Numbers
	420208
Rated Voltage:	120 Volt AC
Rated Cycle:	60Hz
Power Factor (HID):	0.99
Power Cord Length:	1 meters
Dimensions Light Only (L x W x H):	22.6 x 24.7 x 9 (cm) 8.9 x 9.7 x 3.5 (in)
Ballast Cord Length:	2.5 meters

SUSPENSION HARDWARE (INCLUDED)

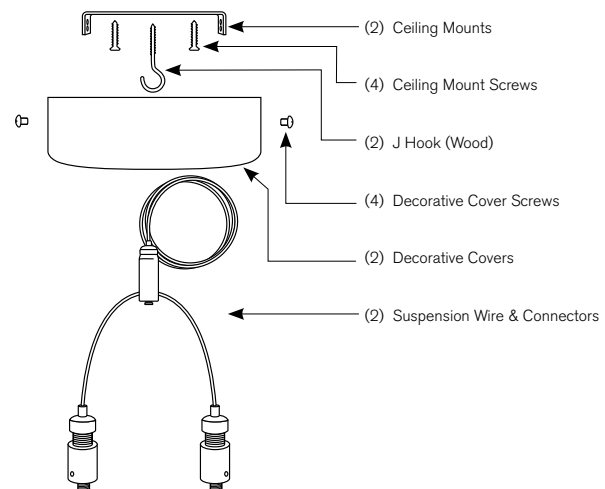

12IN PENDANT INSTALLATION

Tools required for installation: 1) Phillips #2 Screwdriver

ASSEMBLY



TIP: Use a large towel under the fixture during assembly to avoid scratching the fixture.

The Aquatic Life Light Fixture is shipped without the HID Lamp installed. Some assembly of the unit is required prior to operation.

- 1) Place the light fixture upside down on a surface that will not mar or scratch the finish.
- 2) Remove the two screws securing one of the end plates.

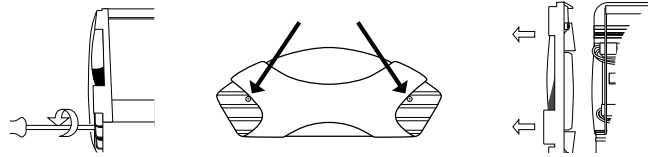

- 3) Remove the glass lens cover from the light.

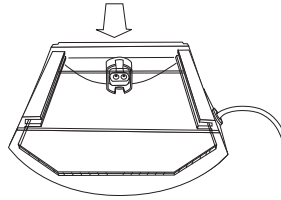

- 4) Grasp the Lamp with soft cloth and gently insert into socket.

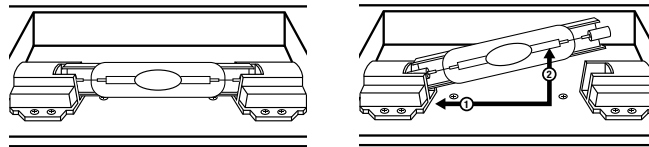

- 5) Install the new Lamp and replace the End Plates and the two screws.

J HOOK

Locate a wood support structure above the aquarium, determine the location for the attachment of the J hooks and secure the hook into the wood.



TIP: Aquatic Life recommends the use of a stud finder to locate an appropriate wood support.

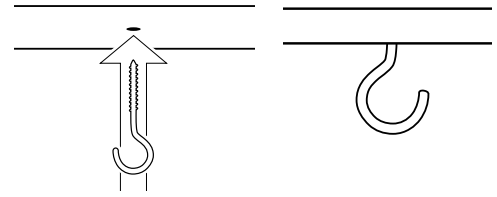

CEILING MOUNT

Position each ceiling mount over the J Hook. Align the hook in the center of the ceiling mount hole. Use the two ceiling mount screws to secure to the surface.

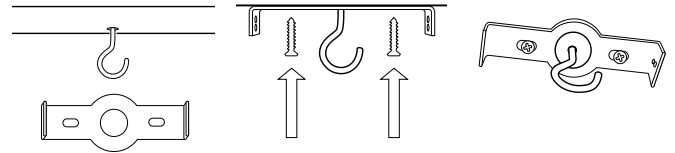

FIXTURE ATTACHMENT

Remove one of four Philips head screws from the top of the light fixture. Insert one of the two fixture connectors from the suspension wire into the vacant opening left by the removed screw. Repeat for the other screw on that end of the fixture. Secure the opposite suspension hardware to the fixture in the same manner.

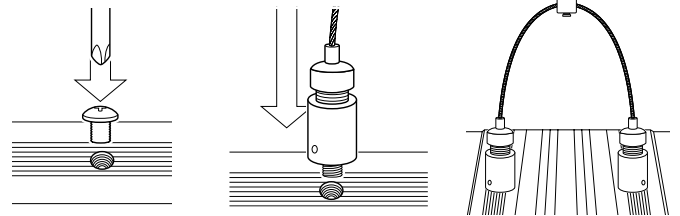

WARNING: Only remove one screw at a time.

FIXTURE PLACEMENT AND ADJUSTMENT

To adjust the height of the fixture above the aquarium, first make sure the wire anchor is tight to the wire and that there is a loop that can be placed over the J Hook in the ceiling.



WARNING: It is extremely important to make sure the anchor is tight and cannot move. The anchor keeps the light secure to the ceiling.

Place the loop of wire onto the J Hook and allow the wire to suspend from the hook.



NOTE: Slide the Decorative Cover down the wire until it meets the top of the adjustment hardware above the fixture.

Pull any excess wire through the adjustment hardware located above the fixture. Level the fixture and measure the amount of extra wire pulled through the adjustment hardware. You will need the measurement for the next step in the installation.

Remove the suspension wires from the J Hooks. Loosen the two screws located in the wire anchor so that the wire can slide freely in the anchor. The amount of extra wire pulled through the adjustment hardware should now be pulled through the wire anchor.

After the extra wire is pulled through the wire anchor, secure the two screws in the anchor. Place the loop in the suspension wire back over the J Hooks in the ceiling.

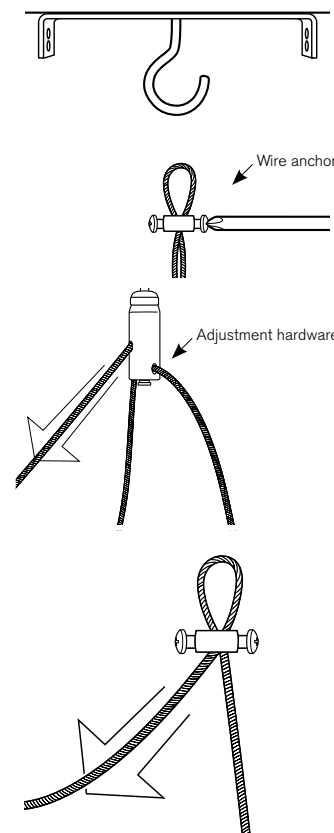

DECORATIVE COVER

Pull the Decorative Cover up and over the ceiling mount and attach the two Decorative Cover screws into the side opening. Secure the Cover.

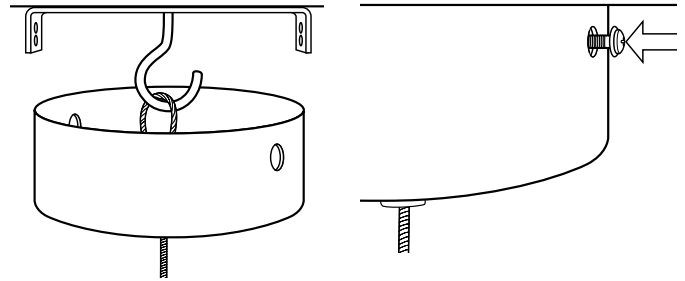

To loosen the wire pulled through the adjustment hardware, press the small button that is positioned around the wire at the top of the hardware. Gently pull down on the adjustment hardware until the fixture is back to where originally measured.

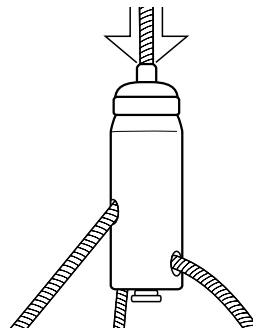

BALLAST INSTALLATION

- 1) Connect the light fixture housing cord to the ballast cord. Press the Male/Female sections of the connector together.

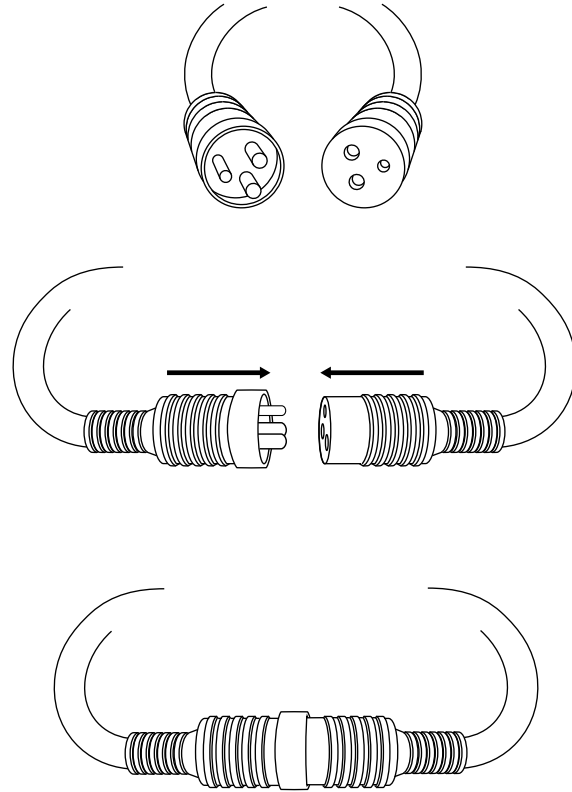

- 2) Locate the ballast in a location that is not exposed to moisture. Keep dry.
- 3) Attach the power cord to an electrical outlet and turn power switch to the on position.

420/460: Light which produces an identifiable or measurable change when it interacts with matter. Actinic lighting is visibly blue and will need a full spectrum bulb to help offset the color distortion. The light wavelength promotes the growth of Zooxanthellae algae, essential for the growth and well-being of all photosynthetic corals and invertebrates. 420/460 Lamps produce a peaked wavelength on the light spectrum at 420 nm and again at 460 nm.

10,000K: A spectrum that produces a full range of white light that is beneficial to Marine organisms. The Lamp mimics the color of light that can be found in equatorial regions of the world. 10,000K Lamps produce light over a broad range of the light spectrum up to 700 nm.

Drip Loop: To arrange an electrical cord so it hangs down well below the outlet before running back up again. Any water running down the cord will drip down from the loop, rather than running uphill to enter the outlet.

GFCI: Ground Fault Circuit Interrupter, a device used to measure if any electrical current is "leaking" from the circuit. If a "leak" is determined the GFCI will switch the power off.

High Intensity Discharge (HID): Lamps that produce light by means of an electric arc between electrodes housed inside a fused quartz tube that contains gas and metal salts. The gas facilitates the arc's initial strike. Once the arc is started, it heats and evaporates the metal salts forming plasma, which greatly increases the intensity of light produced by the arc and reduces its power consumption. Compared with fluorescent and incandescent lamps, HID lamps have higher luminous efficacy since a greater proportion of their radiation is in visible light as opposed to heat. HID Lamps produce a greater amount of light output per watt of electricity input.

Light Emitting Diode (LED): A diode is the simplest sort of semiconductor device. The semiconductor material for LED's is typically aluminum-gallium-arsenide (AlGaAs). In pure aluminum-gallium-arsenide, all of the atoms bond perfectly to their neighbors, leaving no free electrons (negatively-charged particles) to conduct electric current. Light is produced from energy that can be released by an atom. It is made up of many small particle-like packets that have energy and momentum but no mass. These particles, called photons, are the most basic units of light. Photons are released as a result of the moving electrons.

Nanometer (nm): A unit in which wavelengths of light are expressed. 1 nm = 0.000000001 meter (1 billionth of a meter).

Power Factor: A measure of the effectiveness with which an electrical device converts volt-amperes to watts.

T5 HO Lamp: A type of high output fluorescent lamp with a 5/8" diameter. This slim profile makes T5 lamps more efficient than standard fluorescent tubes. T5 HO lamps offer many benefits; including long lamp life, power efficiency, high lumen out, high output per watt, and small size. Like all fluorescent lamps, T5 HO Lamps contain mercury and should be disposed of properly. Visit www.lamprecycle.org to learn more about disposal.

REGISTERING YOUR PRODUCT(S) WITH AQUATIC LIFE

When you purchase an Aquatic Life product, you will find a Warranty Registration Card accompanying the product. Please complete this Card and mail it in within 15 days from the date of purchase or register your product online at www.aquaticlife.com. Some Aquatic Life products will include a Serial Number. To validate your warranty, the Serial Number must be included for appropriate products.

Product Serial Numbers

Serial Numbers DO NOT contain the letters "UL", "CUL", "CSA", "EN" or "CE". These letters refer to a US, Canadian and European Standards for that product. If you need help locating the Serial Number for your product, please visit our website at www.aquaticlife.com or call Aquatic Life at 1-888-548-3480.

LIMITED WARRANTY

Aquatic Life, LLC warrants that this Light Fixture (excluding lamps) shall be free from defective electrical components and leaks or cracks due to defects in materials or workmanship for a period of twelve (12) months from the date of purchase. If a defect is shown, Aquatic Life, LLC will, at Aquatic Life's sole discretion, either repair or replace the product without charge. No cash refunds will be made. This warranty is provided solely to the original consumer purchaser of the product and may not be transferred or assigned.

This warranty does not apply to damage resulting from accident, misuse, abuse, lack of reasonable care, failure to follow safety and installation instructions, use of the product with non-standard electrical service, or any other defect not resulting from defects in the electrical components of the product or defects in materials or workmanship. This warranty will not be effective unless and until the Aquatic Life product is shown to have been used in accordance with the safety and installation instructions accompanying the product.

THIS CONSTITUTES AQUATIC LIFE'S ENTIRE WARRANTY AND AQUATIC LIFE MAKES NO OTHER WARRANTIES, WHETHER EXPRESS OR IMPLIED, WITH RESPECT TO THE PRODUCT. AQUATIC LIFE, LLC SPECIFICALLY DISCLAIMS ANY AND ALL IMPLIED WARRANTIES, INCLUDING, WITHOUT LIMITATION, WARRANTIES OF MERCHANTABILITY AND FITNESS FOR A PARTICULAR PURPOSE. IF AQUATIC LIFE, LLC CANNOT LAWFULLY DISCLAIM IMPLIED WARRANTIES UNDER THIS LIMITED WARRANTY, ALL SUCH WARRANTIES, INCLUDING WARRANTIES OF MERCHANTABILITY AND FITNESS FOR A PARTICULAR PURPOSE ARE LIMITED IN DURATION TO THE DURATION OF THIS WARRANTY.

AQUATIC LIFE IS NOT RESPONSIBLE FOR DIRECT, SPECIAL, INCIDENTAL OR CONSEQUENTIAL DAMAGES RESULTING FROM ANY BREACH OF WARRANTY OR CONDITION, OR UNDER ANY OTHER LEGAL THEORY. AQUATIC LIFE, LLC EXPRESSLY DISCLAIMS ALL ALLEGED DAMAGES FOR LOSS OF MARINE LIFE, PERSONAL INJURY, AND/OR PROPERTY DAMAGE.

Some states and provinces do not allow the exclusion or limitation of incidental or consequential damages or exclusions or limitations on the duration of implied warranties or conditions, so the above limitations or exclusions may not apply to you. This warranty gives you specific legal rights, and you may also have other rights that vary by state or province.

Aquatic Life, LLC shall not have any obligations under this warranty unless the owner notifies Aquatic Life, LLC in writing of any alleged defect(s) within 30 days of discovery of the defect(s). Any notice to Aquatic Life, LLC must be delivered by United States or electronic mail to the following address:

U.S. Mail

Aquatic Life, LLC

2416 W. Victory Blvd, #136

Burbank, CA 91506

Electronic Mail: customersupport@aquaticlife.com

Aquatic Life, LLC shall be allowed a reasonable period of time to investigate any warranty claim and to perform any testing Aquatic Life, LLC deems necessary to determine the cause of the defect. This warranty shall be interpreted under the laws of the State of California.



Aquatic Life, Life Rewards, and
"Bringing the ocean to you, wherever you may be."
are trademarks of
Aquatic Life LLC
Commerce, CA 90040
www.aquaticlife.com

© Copyright Aquatic Life LLC

P/N 9000313 REV 05/11