

14" XS-UV LED MARINE LIGHT FIXTURE

DESCRIPTION

- LIGHT FIXTURE USING 3 WATT CREE AND SEMILED LED'S DESIGNED FOR KEEPING REEF AQUARIUMS

UPC#

- 810957013097

APPEARANCE

- BLACK ANODIZED FINISH
- ILLUMINATED OPERATION DISPLAY
- BLUE ACCENT PANELS

ELECTRICAL & OPERATING REQUIREMENTS

- RATED VOLTAGE: 115/230 VOLT AC
- RATED CYCLE: 50-60 HZ
- POWER FACTOR: 0.56
- INPUT CURRENT: 1.38 AMPS
- MAXIMUM FIXTURE WATTAGE: 91 W
- POWER CORD LENGTH: 1.8 METER
- FIXTURE CORD LENGTH: 2.9 METERS
- USB CORD: 3 METERS

REFLECTORS

- INDIVIDUAL 80° AND 100° LENSES

SIZE & WEIGHT

- **PACKAGING**
 - 24 X 15.75 X 5.25 IN
 - 60.96 X 40 X 13.335 CM
 - 15.60 LBS / 7.08 KG
- **PRODUCT (WITHOUT POWER SUPPLY)**
 - 14.625 X 12.125 X 2.125 IN
 - 37.2 X 30.8 X 5.4 CM
 - 9.10 LBS / 4.13 KG

PACKAGING

- **BOX**
 - REINFORCED FLEXOGRAPHY PRINTED BROWN CARDBOARD, WITH FOUR COLOR LABEL

OPTIONAL ACCESSORIES

- 60° LENSES
- UNIVERSAL FIXTURE HANGERS
- SUSPENSION HARDWARE

WARRANTY & PRODUCT REGISTRATION

- 12 MONTH LIMITED WARRANTY
- LIFETIME REPAIR GUARANTEE (INCLUDED)



14" XS-UV LED Light Fixture



Remote Control



Suspension Hardware (Included)

FEATURES

- HIGH OUTPUT AMERICAN-MADE MIXTURE OF CREE AND SEMILED'S LED'S PRODUCE SPECTRUM OF LIGHT DESIGNED FOR GROWING CORALS
- EASILY ADJUST LIGHT TO ADAPT TO CHANGING TANK ENVIRONMENT BY PROGRAMMING UP TO THREE INDEPENDENT 24 HOUR LIGHT CYCLES
- INCLUDED REMOTE EASILY CONTROLS MULTIPLE LIGHT CYCLE PROGRAMS AND LIGHTING EFFECTS
- DOWNLOADABLE SOFTWARE IS AVAILABLE FROM WEB FOR COMPLETE LIGHT CYCLE AND COLOR COMBINATION PROGRAMMING
- FRONT PANEL INDICATOR VIVIDLY DISPLAYS CURRENT OPERATING LIGHTING PROGRAM

LED'S

- (6) CREE XTE (WHITE)
- (6) CREE XTE (ROYAL BLUE)
- (8) CREE XPE (BLUE)
- (2) SEMILED'S 420nm (ACTINIC BLUE)
- (1) SEMILED'S 400nm (VIOLET)
- (2) SEMILED'S 620nm (RED)

CONTENTS

- (1) 14 IN LED FIXTURE
- (1) SUSPENSION HARDWARE
- (1) REMOTE CONTROL
- (1) cULus APPROVED POWER SUPPLY
- (1) USB CABLE

Spectral Output

WHITE

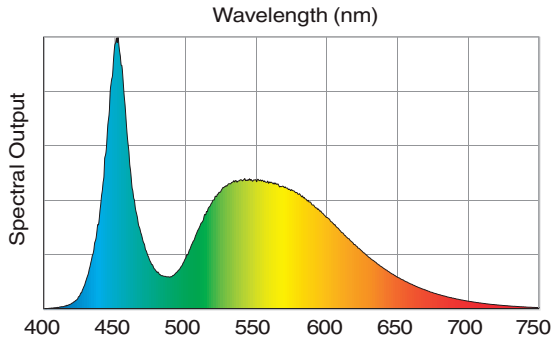

400nm

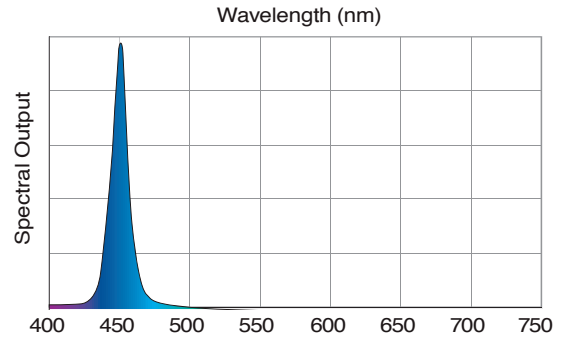

ROYAL BLUE

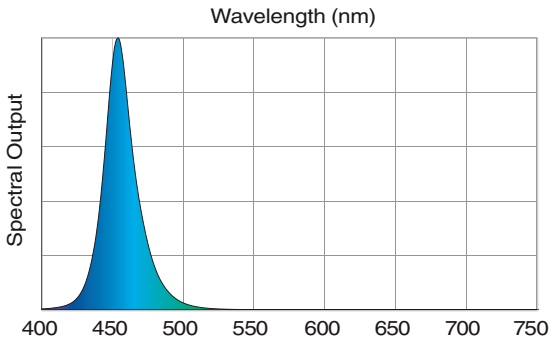

420nm

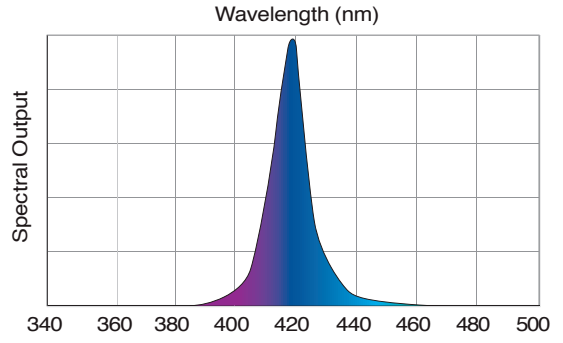

BLUE

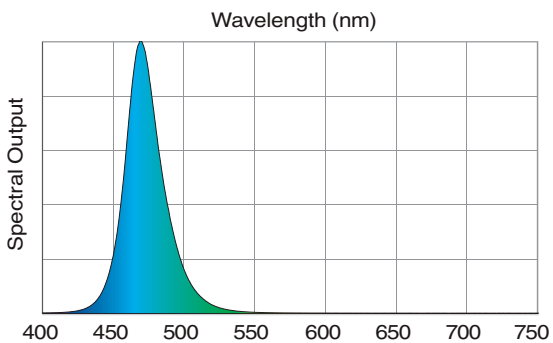

RED

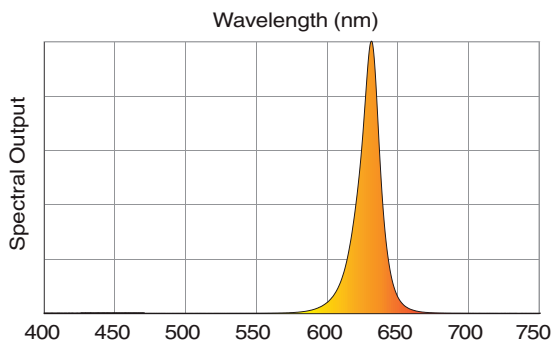
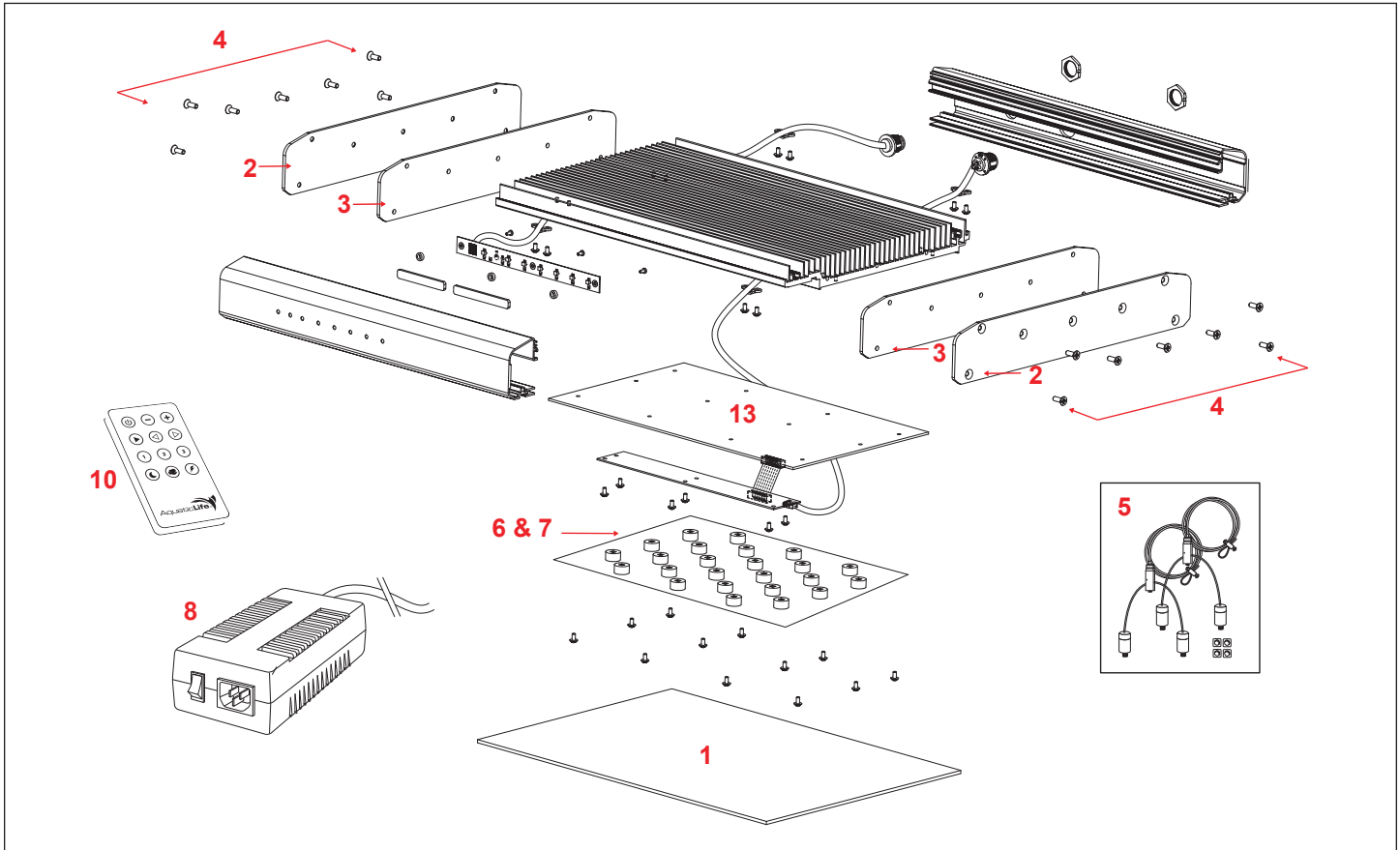

DIAGRAM DOES NOT REFLECT ACTUAL SIZE



14" XS-UV LED MARINE LIGHT FIXTURE

DIAGRAM NUMBER	ITEM NUMBER	PART DESCRIPTION
1	9000535	Lens Cover Acrylic
2	9000594	End Plate Exp LED 3W (universal)
3	9000595	End Plate Blue Accent LED 1W (universal)
4	9000596	Screws LED 3W End Plate/Accent Plate (14 PK)
5	470281	Suspension Hardware (optional)
6	9000573	Reflector LED 100 Deg (6 PK)

DIAGRAM NUMBER	ITEM NUMBER	PART DESCRIPTION
7	9000574	Reflector LED 80 Deg (6 PK)
8	470129	Power Supply (w/switch)
9	9000531	USB Cable (3 meters) (not shown)
10	9000587	Remote Control
11	470262	Aquarium Frame Mounts
12	9000589	Power Cord (1.8 meters) SVT 18 AWG
13	470312	XS-UV LED Board