

# LED FLOOD LIGHT

Product Manual

MODEL: J65

## COMPONENTS AND STRUCTURE

J65

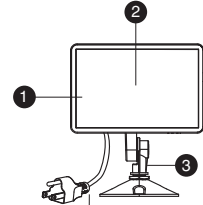
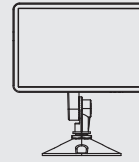

- 1. Cover
- 2. LED Light Source
- 3. Lamp Bracket

US 1.5m(4.92ft)  
3x18AWG

## PARTS LIST



**A** Machine Screw  
QTY: 2



**B** Expansion Rubber Plug  
QTY: 2



**C** EVA Gasket  
QTY: 1

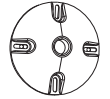

**D** Mounting Bracket  
QTY: 1

2



## SPECIFICATIONS

LED FLOOD LIGHT	
Model	J65
Input Voltage	120-277V ~ 50/60Hz
Input Current	0.54A
Rated Power	65W
Luminous Flux	7800lm
CCT	6500K
CRI	≥80
Power Factor	≥0.9
L70B50 lifetime	30000hours L70B50 @ 25°
Beam Angle	120°
ta	-20-40°C/-4°F-104°F
Luminaire Location	<b>SUITABLE FOR WET LOCATIONS</b>
DIMENSIONS	
Model	J65
Dimensions (LxHxW)	174x217x113 mm/ 6.85x8.54x4.45in
Weight	0.91 kg/2.01 lb

3



## PREPARATION

### NOTE:

Check all components for damage, do not use the product if it is damaged.  
Estimated Assembly Time:15-30 minutes.

Product appearance may vary from image shown.

### TOOLS REQUIRED (not included)



Flathead  
screwdriver



screwdriver

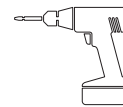

Electric drill



Eye Protection



Wrench



Pliers



Step Ladder

### WARNING:

**THIS PRODUCT MUST BE INSTALLED IN ACCORDANCE WITH THE APPLICABLE INSTALLATION CODE BY A PERSON FAMILIAR WITH THE CONSTRUCTION AND OPERATION OF THE PRODUCT AND THE HAZARDS INVOLVED.**

### CAUTION:

**PLEASE MAKE SURE YOUR WALL SWITCH AND POWER AT MAIN CIRCUIT BREAKER BOTH ARE OFF.**  
**IF IN DOUBT ABOUT ELECTRICAL INSTALLATION, CONSULT A LICENSED ELECTRICIAN.**

4



## PREPARATION

### RISK OF SHOCK:

BEFORE BEGINNING INSTALLATION, TURN OFF ELECTRICITY AT THE CIRCUIT BREAKER BOX OR THE MAIN FUSE BOX.

### NOTE:

BE SURE TO USE WIRE NUTS/CONNECTORS RATED FOR THE CORRECT GAUGE AND NUMBER OF WIRES USED.

MAKE SURE THERE ARE NO EXPOSED WIRE BUNDLES OUTSIDE THE WIRE NUT/CONNECTOR (IF APPLICABLE).

BE CAREFUL NOT TO DAMAGE OR CUT THE WIRE INSULATION (COVERING) DURING INSTALLATION. DO NOT LET THE WIRES TOUCH ANY SHARP EDGES.

### WARNING:

DO NOT CONNECT THIS LIGHT FIXTURE TO AN UNGROUNDED ELECTRICAL SYSTEM. ATTACH GROUND FIXTURE WIRE TO EITHER GREEN GROUND SCREW ON MOUNTING PLATE OR THE GROUND WIRE IN THE OUTLET BOX.

INSTALLING THIS LIGHT IN AN UNGROUNDED ELECTRICAL SYSTEM MAY CAUSE THE METAL PARTS OF THE LIGHT TO CARRY CURRENT IF ANY WIRES OR WIRE CONNECTIONS ARE DAMAGED OR LOOSE. IN THIS CASE, ANYONE WHO TOUCHES THE LIGHT WILL RECEIVE AN ELECTRIC SHOCK, RESULTING IN INJURY OR DEATH.

5



## INSTALLATION STEPS

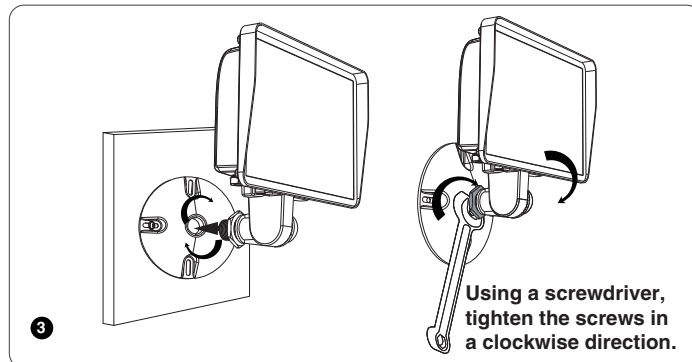
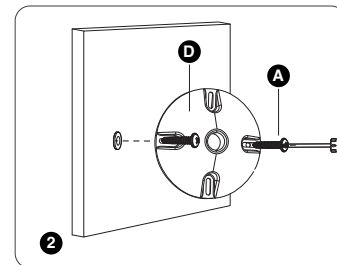
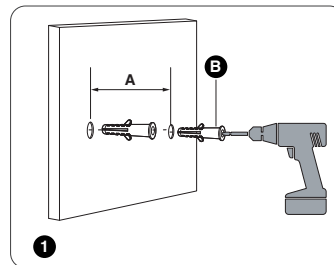

6



## INSTALLATION STEPS

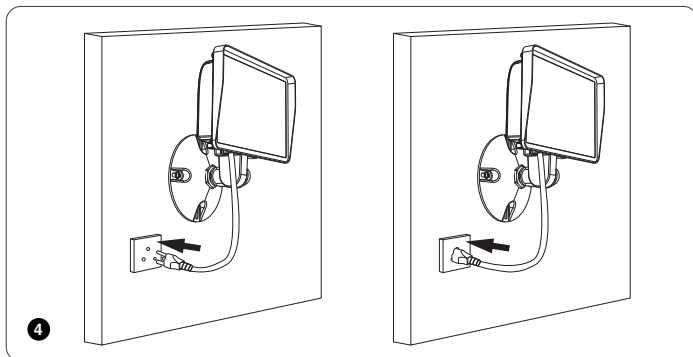

7



### FCC Warning:

Any Changes or modifications not expressly approved by the party responsible for compliance could void the user's authority to operate the equipment.

This device complies with part 15 of the FCC Rules. Operation is subject to the following two conditions:

- (1) This device may not cause harmful interference, and
- (2) this device must accept any interference received, including interference that may cause undesired operation.

Note: This equipment has been tested and found to comply with the limits for a Class B digital device, pursuant to part 15 of the FCC Rules. These limits are designed to provide reasonable protection against harmful interference in a residential installation. This equipment generates uses and can radiate radio frequency energy and, if not installed and used in accordance with the instructions, may cause harmful interference to radio communications. However, there is no guarantee that interference will not occur in a particular installation. If this equipment does cause harmful interference to radio or television reception, which can be determined by turning the equipment off and on, the user is encouraged to try to correct the interference by one or more of the following measures:

- Reorient or relocate the receiving antenna.
- Increase the separation between the equipment and receiver.
- Connect the equipment into an outlet on a circuit different from that to which the receiver is connected.
- Consult the dealer or an experienced radio/TV technician for help.

HK Bright International Lighting Co., Limited  
Unit 616, 6/F., Kam Teem Industrial Building, 135  
Connaught Road West, Sai Wan Hong Kong

Manufacturer/Hersteller: MDH LIGHTING LTD  
Suite 302, 292 Strovolos Avenue, 2048 Strovolos Nicosia,  
Cyprus

UK Importer: MDH LIGHTING LTD  
69 Aberdeen Avenue, Cambridge CB2 8DL,  
United Kingdom

Made in China

✉ support@onforuled.com 🌐 www.onforuleds.com

