

# WIRELESS SPEAKER

Product Manual

Model: Onforu SK01  
Speaker's Name: A SPEAKER10

## SAFETY INSTRUCTIONS

1. Read all instructions and save them for personal reference in the future.
2. Do not place naked flame sources, such as lighted candles, near the product.
3. The product contains a battery pack, so should not be exposed to excessive heat.
4. Do not hit the product seriously to avoid damaging the product.
5. Clean with dry cloth only.
6. Only use attachments/accessories specified by the manufacturer.
7. Do not place products on an unstable surface, such as a cart, stand, tripod, etc. which may make the product fall and cause serious injury to people and serious damages to the product. Follow all manufacturer instructions for mounting and accessories.
8. Do not block or cover ventilation slots. Openings in the product cabin ensure efficient cooling and prevent overheating. Avoid placing the product on beds, sofas, and rugs, unless proper ventilation is provided.
9. Prevent power cord hazards. Route cords to prevent stepping on or pinching them, especially at the plug ends and the connection of the product & power outlets.
10. Unplug this apparatus during lightning storms or when unused for long periods of time.
11. Do not set up near heat sources. Avoid radiators, stoves, and other devices that produce heat. Avoid long exposure to sunlight and high temperatures.
12. Do not make unauthorized alterations to the product; doing so may compromise safety, regulatory compliance, system performance, and may void the warranty.
13. Do not get close to magnetic fields or electric fields.
14. The maximum ambient temperature during use of the appliance must not exceed 35°C.
15. Suitable for safe use in tropical and non-tropical areas.
16. Only suitable for safe use in areas below, 2000m above sea level.
17. Please use 5V adapter for charging.



## SPECIFICATIONS

WIRELESS SPEAKER	
Model	Onforu SK01
Speaker's Name	A SPEAKER10
Input	11.1V --- 2.2A
	V5.0
Batteries	3.7V 3*2200mAh
	15-20m/49.2-65.6ft Max
DIMENSIONS	
Model	Onforu SK01
Dimensions (LxWxH)	172x158x 295 mm/ 6.77x 6.22x 11.61in
Weight	2.1 kg / 4.63 lb

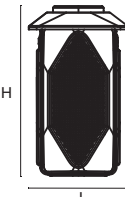
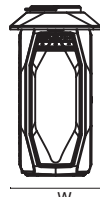

## COMPONENTS AND STRUCTURE

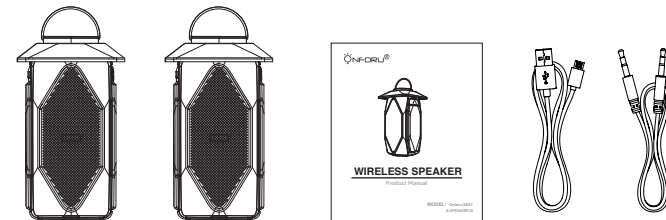

1. Speaker \* 2
2. User Manual \* 1
3. USB Cable \* 1 (0.6m)
4. AUX Cable \* 1 (1m)

## PRODUCT DESCRIPTION

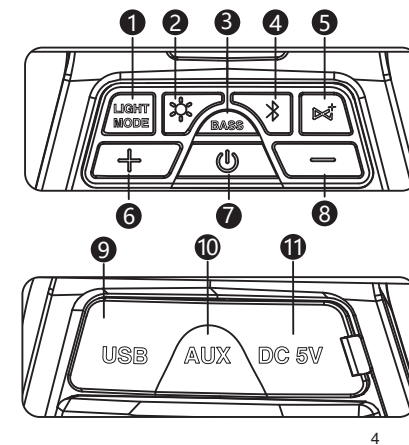

- 1 LIGHT MODE
- 2 Light Brightness Adjustment
- 3 BASS Button (Sound Effect)
- 4 Bluetooth-button
- 5 TWS
- 6 Vol Up/Next
- 7 Power On/Off
- 8 Vol Down/Prev
- 9 Can Charge Other Devices (5V 2A)
- 10 Aux Input Mode
- 11 Charging Port



## PRODUCT DESCRIPTION

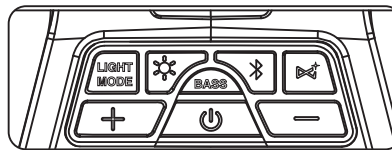

Button	Instruction	Beep and Light-Status	Note
	Long press for 2S: Power on / off Short press 1S: Play/Pause	Power on/off prompt sound	Automatically off if 30 minutes with no connection.
	Short press: Volume up Long press: Next song	Maximum volume beep - 1 quick beep - beep beep	The volume has a memory function, it will automatically save the volume before turning off.
	Short press: Volume down Long press: Previous song	Minimum volume beep - 1 quick beep - beep beep	
	1. Switch on the two speakers at the same time, the two speakers will be paired and connected with each other. If the connection is successful, the voice "TWS Mode" will be reported. 2. When the interconnection is successful, the blue light of one of them will flash. When the connection with the mobile phone is successful, the blue light will be gone Flashing. 3. After successfully connecting to the mobile phone, press any of the "BT" to disconnect. After disconnection, press and hold the "BT" of any speaker for 3 seconds to reconnect. After success, the voice "TWS Mode" will be reported.	Tws mode and blue flash	What should I do if I can't pair? Method 1: please press the "BT" button on the speakers for two seconds, after clear memory, turn off the two speakers, and then re-open the speakers, the two speakers will be automatically paired. Method 2: Turn off the two speakers, delete the name (A SPEAKER10) of the two speakers in the Bluetooth connection on the phone (other devices), then turn on the two speakers again, the two speakers will be paired automatically.*
	Short press 1S: Bluetooth Mode ( Default BT mode when booting ) After connecting the audio cable, the device will default to audio mode. Short press once to switch to Bluetooth mode	Bluetooth mode and blue light flashing	
	Long press 2S: Disconnect and clear Bluetooth memory		
	Short press 1S: Light Brightness Adjustment ( 20%, 40%, 60%, 80%, 100% ) , Brightness can only be adjusted in the modes of jump, gradient, and fixed color		
<b>LIGHT MODE</b>	Short press 1S: Light mode selection 1. RGB horse racing streamer (rainbow light) 2. Flash with music 3. RGB jump (red, orange, yellow, green, cyan, blue, purple, warm white) 4. Breathing gradient (red, orange, yellow, green, cyan, blue, purple, warm white) 5. Fixed color ( In the breathing gradient mode, pressing the "Light Mode" button once can fix the displayed color ) 6. Flame lamp 7. Turn off the lights		The lighting effect has a memory function, it will automatically save the lighting effect before turning off.
<b>BASS</b>	Short press 1S: sound effect selection Normal sound mode BASS mode Outdoor sound mode	Blue light flashes 1 time quickly	The sound effect has a memory function, it will automatically save the sound effect before turning off.



## TWS PAIRING

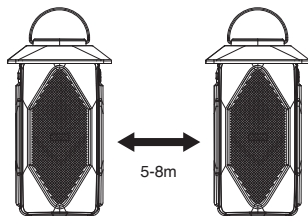

### TWS interconnection

1. Switch on the two speakers at the same time, the two speakers will be paired and connected with each other. If the connection is successful, the voice "TWS Mode" will be reported.
2. When the interconnection is successful, the blue light of one of them will flash. When the connection with the mobile phone is successful, the blue light will be gone Flashing
3. After successfully connecting to the mobile phone, press any of the "⏮" "⏭" to disconnect. After disconnection, press and hold the "⏮" "⏭" of any phone for 3 seconds to interconnect. After success, the voice "TWS Mode" will be reported.

**Note:** The best distance between the two speakers should be controlled between 5-8M. If the range is too large or too small, the information transmission between the speakers will be affected.



## BLUETOOTH MODES

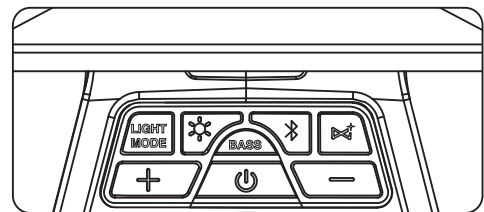

1. Hold the "⏻" to turn the speaker on. The speaker will automatically enter Bluetooth mode by default. You will hear the prompt tone and the blue indicator light will flash quickly.
2. The first time that you pair the speakers and your device, you should turn your device's Bluetooth function on and search for the speaker. The device will display the speaker's name "A SPEAKER10". Tap the speaker's name and it will automatically pair with your device. After successfully pairing, the speaker will beep and the indicator light will stay blue.
3. If you want to connect different device with this speaker, Long press "⏮" 2s to cut the present bluetooth connection. And then follow the above 2 steps to enter bluetooth pairing mode.

## AUX INPUT MODE

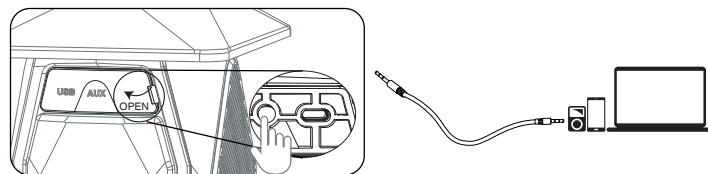

If your device is not bluetooth-enabled, easily connect with TV or other devices via this 3.5 mm audio cable.

After the speaker and the device are connected through the audio cable, the speaker will be defaulted to the audio mode, short press the "⏮" can be switched to the Bluetooth mode.



## USB CHARGING

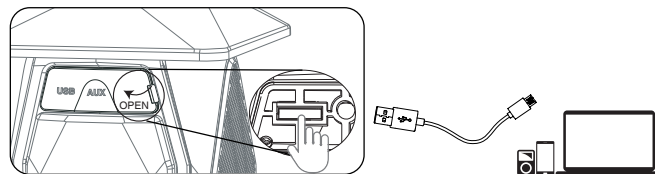

### Charge other devices

Plug in the USB cable and connect it to other devices to charge other devices.

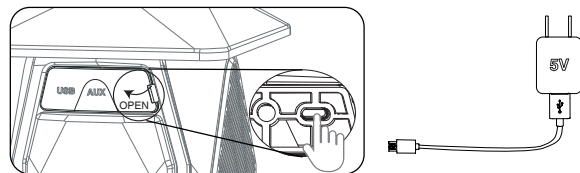

### Speaker Charging

When the speaker battery is low, the speaker will "ding ding" three times, and then the speaker will automatically turn off.  
Please charge the speakers with the supplied USB charging cable and use the DC power adapter that is less than 5V.  
While the speaker is charging, you will see a red indicator light is always on. Once the speaker is fully charged, the indicator light will turn off.

### Note

1. When you turn on the speaker, it will automatically search for the device connected recently. If the bluetooth of the device is activated, the speaker will automatically connect and pair. After successfully pairing, you will hear a beep sound.
2. Bluetooth has an effective communication range of 15 meters. Make sure there are no large obstructions within this range. To ensure a stable connection, it's best to use the speaker within 5 meters of your device.
3. The speaker will automatically turn off in 30 minutes if there is no bluetooth connection or no music played.



## SOLUTIONS TO COMMON PROBLEMS

Problemas	Solutions
Multiple attempts to connect but failed	1. Check if the product is in search status, or restart. 2. There are too many peripheral Bluetooth devices, making searching difficult, you should turn off other Bluetooth devices.
The sound is low or distorted	1. Check the volume of the Bluetooth device and adjust its volume to a suitable position. 2. Please charge the speaker if the battery voltage is low.
The sound is not continuous	Check whether the distance between the speaker and the Bluetooth device exceeds the effective audio connection distance, or there is an obstacle between them.
What should I do if I can't pair ?	1. please press the "⏮" button on the speakers for two seconds, after clear memory, turn off the two speakers, and then re-open the speakers, the two speakers will be automatically paired. 2. Turn off the two speakers, delete the name of the two speakers in the Bluetooth connection on the phone (other devices), then turn on the two speakers again, the two speakers will be paired automatically."



This symbol means the product must not be discarded as household waste, and should be delivered to an appropriate collection facility for recycling. Follow local rules and never dispose of the product and rechargeable batteries with normal household waste. Correct disposal of old products and rechargeable batteries helps prevent negative consequences for the environment and human health.



## FCC ID: 2A3W8ASPEAKER10

### FCC Warning:

Any Changes or modifications not expressly approved by the party responsible for compliance could void the user's authority to operate the equipment.

This device complies with part 15 of the FCC Rules. Operation is subject to the following two conditions:

- (1) This device may not cause harmful interference, and
- (2) this device must accept any interference received, including interference that may cause undesired operation.

Note: This equipment has been tested and found to comply with the limits for a Class B digital device, pursuant to part 15 of the FCC Rules. These limits are designed to provide reasonable protection against harmful interference in a residential installation. This equipment generates uses and can radiate radio frequency energy and, if not installed and used in accordance with the instructions, may cause harmful interference to radio communications. However, there is no guarantee that interference will not occur in a particular installation. If this equipment does cause harmful interference to radio or television reception, which can be determined by turning the equipment off and on, the user is encouraged to try to correct the interference by one or more of the following measures:

- Reorient or relocate the receiving antenna.
- Increase the separation between the equipment and receiver.
- Connect the equipment into an outlet on a circuit different from that to which the receiver is connected.
- Consult the dealer or an experienced radio/TV technician for help.

### Radiation Exposure Statement

The device has been evaluated to meet general RF exposure requirement.  
The device can be used in portable exposure condition without restriction.

HK Bright International Lighting Co., Limited  
Unit 616, 6/F., Kam Teem Industrial Building, 135  
Connaught Road West, Sai Wan Hong Kong  
Manufacturer/Hersteller: MDH LIGHTING LTD  
Suite 302, 292 Strovolos Avenue, 2048 Strovolos Nicosia,  
Cyprus

UK Importer: MDH LIGHTING LTD  
69 Aberdeen Avenue, Cambridge CB2 8DL,  
United Kingdom

Made in China

✉ support@onforuled.com 🌐 www.onforuleds.com

