

**LN Lighting technical data**

LED PHOTOELECTRIC CONTROL DUSK TO DAWN LIGHT, Outdoor Security  
LED flood light Knuckle Mount, 50 w, waterproof and outdoor  
LED light

**Lighting technical data**  
**LED FLOOD LIGHT is an alternative light source**  
**with longer life and uniformed light distribution**



**RoHS**

**IP66**

LED FLOOD LIGHT



Usage scenario

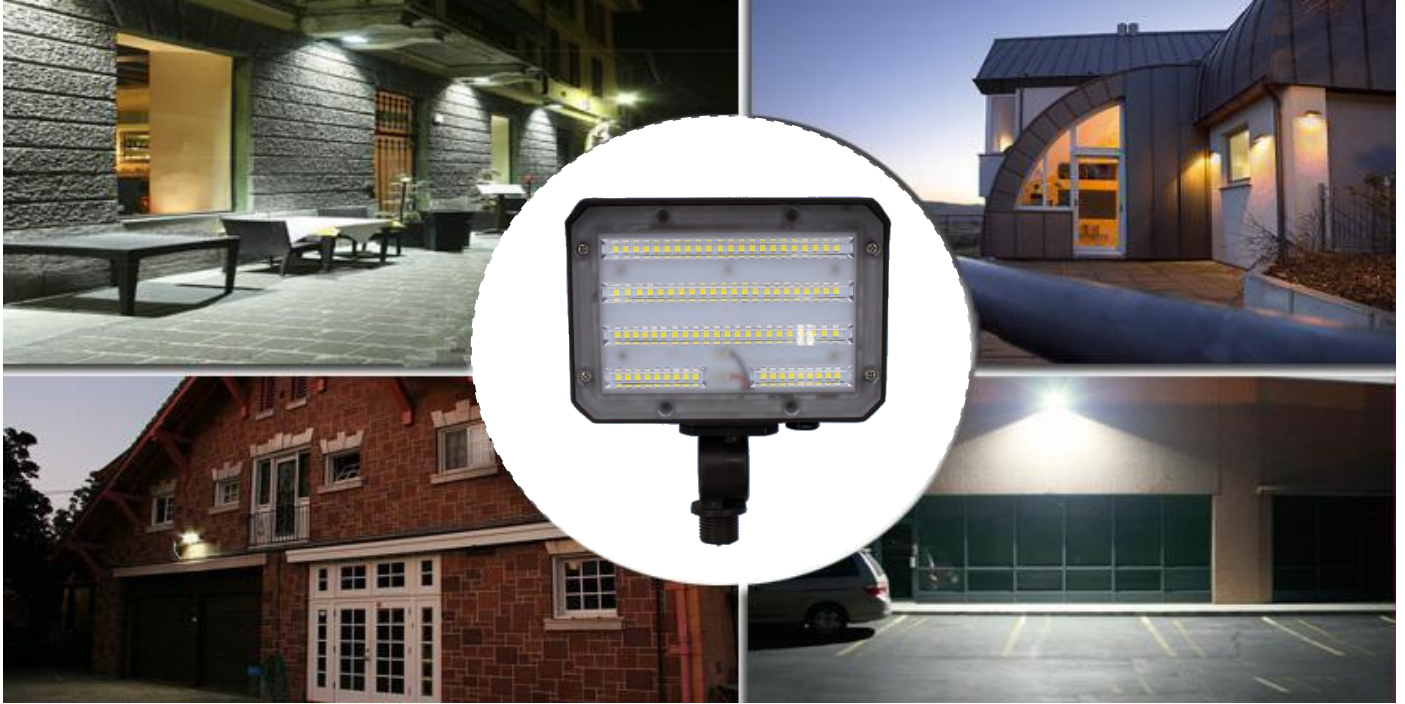

## LED FLOOD LIGHT



## Line-Up

Model No.	Watts(W)	Light Output(lm)	Dimension(mm)	Light Color(K)	Beam Angle(Degree)
LN-FL50-U-LS-CW-BR-U-C-X00	50 ± 10%	7000 -10%	150*159*57	6500K	60*120
LN-FL50-U-LS-QW-BR-U-C-X00	50 ± 10%	7000 -10%	150*159*57	5000K	60*120

## Technical Specifications

Item	Test Conditions	Min.	Typ.	Max.
Input Voltage(V, rms)	AC	100	220	277
Input Current(mA, rms)	AC(120V)	---	227	---
Input Power(W, rms)	AC(All)	---	50	---
Input Frequency(Hz)	AC	---	50 / 60Hz	---
Power Factor(PF)	AC(All)	≥0.9		
ON-OFF Levels	Lx	10~20Lx On (Dusk),30~60Lx Off (Dawn)		

## Environmental Requirements

Specifications	Values
Operational Temperature Range	-40~40℃
Preservation Temperature Range	-40~90℃
Operational Humidity Range	95%Rh or below (@-20~40℃)
Installation Area	Outdoor (Counter,Residential,Commercial,etc)

LED FLOOD LIGHT



Drawing

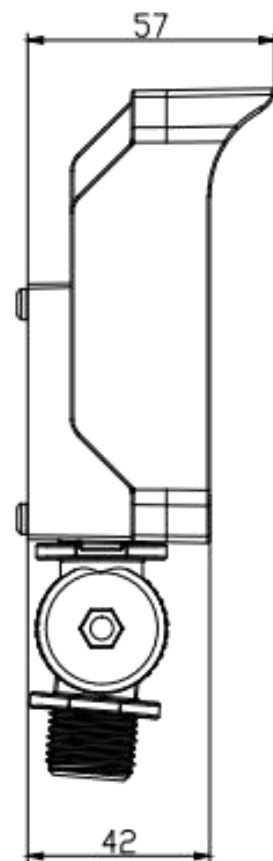
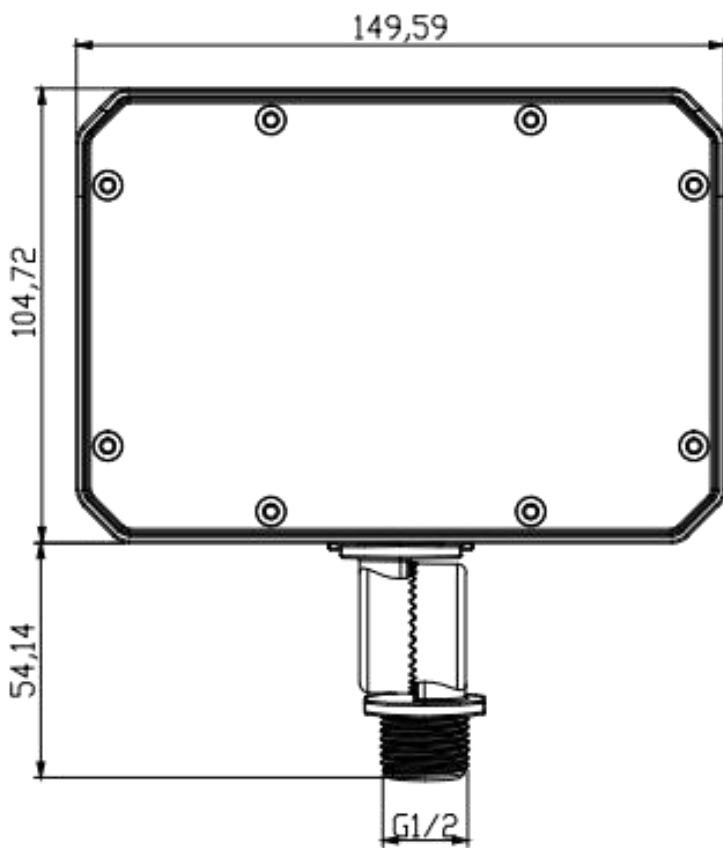

Material	IP
ADC12	IP66
PC	



LED FLOOD LIGHT



LN-FL50-U-LS-CW-BR-U-C-X00

Category	Specifications	Unit
Watts	50	W
Lumens per Watt(Efficacy)	140	Lm/W
Light Output	7000	lm
Light Color(CCT)	6500	K
Beam Angle	60*120	°(degree)
Color Accuracy(CRI)	70	Ra
Product Weight	700	G
Rating Life	50000	H
Base	Line interface	
Input Voltage	100-277	V

Luminance Intensity Distribution

Cone Lux Diagram

LUMINOUS INTENSITY DISTRIBUTION DIAGRAM

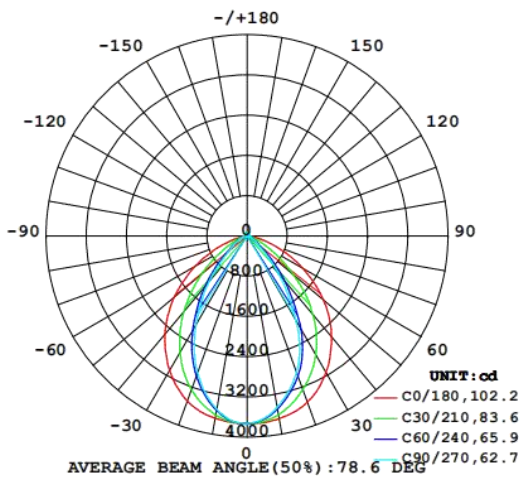

Flux out: 2913 lm

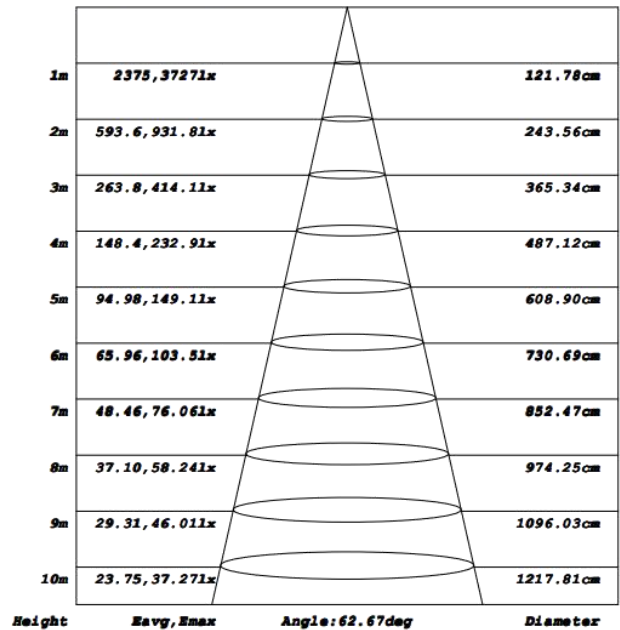

# LED FLOOD LIGHT



LN-FL50-U-LS-QW-BR-U-C-X00

Category	Specifications	Unit
Watts	50	W
Lumens per Watt(Efficacy)	140	Lm/W
Light Output	7000	lm
Light Color(CCT)	5000	K
Beam Angle	60°120	°(degree)
Color Accuracy(CRI)	70	Ra
Product Weight	700	G
Rating Life	50000	H
Base	Line interface	
Input Voltage	100-277	V

Luminance Intensity Distribution

Cone Lux Diagram

LUMINOUS INTENSITY DISTRIBUTION DIAGRAM

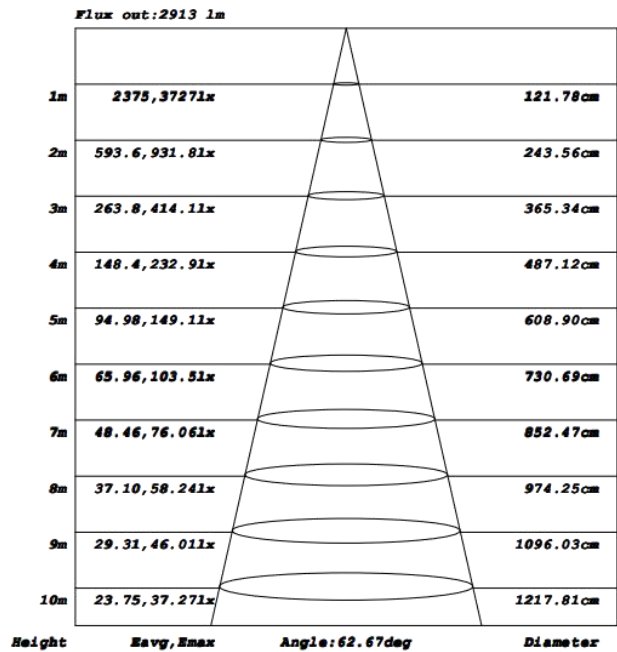
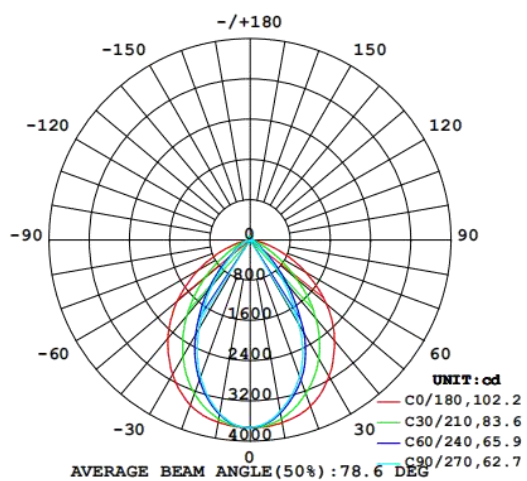

# LED FLOOD LIGHT

---



Product Packaging	Specifications	Unit
Product Dimension	150*159*57	mm
Net Weigh	0.7	Kg
Size of box	155*175*60	mm
Gross Weight	0.73	Kg
Size of Carton	405*340*375	mm
Qty/ Carton	24	PCS
Weight/ Carton	18.8	Kg

### Revision History

Mtime	Changed to: VER	Description of Change		
		Item	From	To