

PIR LED WALL LIGHTS WITH MOTION SENSOR

Product Manual

MODEL: BDBP27G-5

COMPONENTS AND STRUCTURE

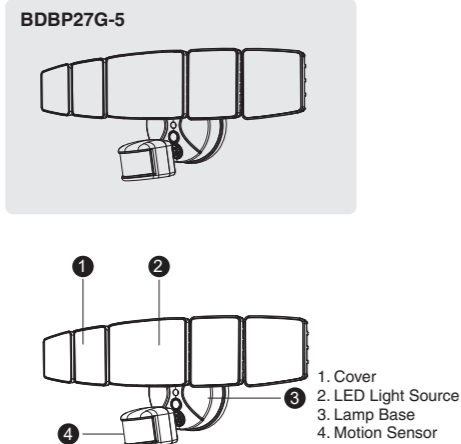

- Cover
- LED Light Source
- Lamp Base
- Motion Sensor



2

PARTS LIST

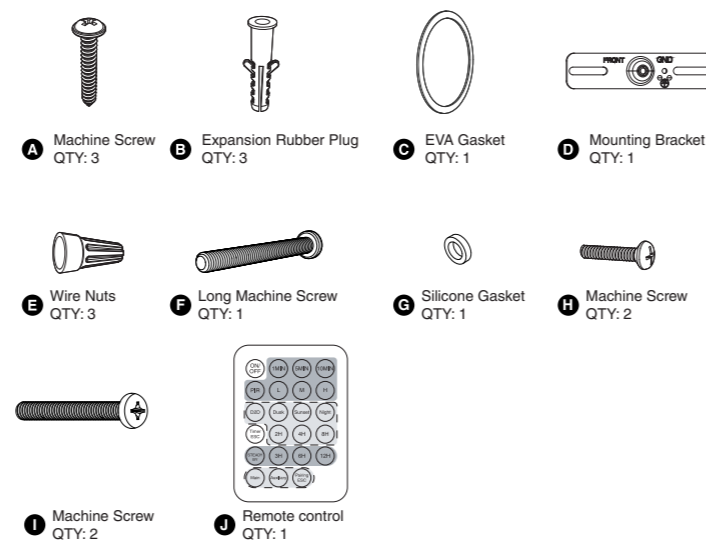

Remote control QTY: 1



3

SPECIFICATIONS

LED WALL LAMP	
Model	BDBP27G-5
Input Voltage	100-120V ~ 60Hz
Input Current	0.3A
Rated Power	27W
Luminous Flux	2800lm
CCT	6500K
CRI	≥80
Power Factor	≥0.9
L70B50 lifetime	30000hours L70B50 @ 25°
Beam Angle	120°
fa	-20-40°C/-4°F-104°F
Luminaire Location	SUITABLE FOR WET LOCATIONS
DIMENSIONS	
Model	BDBP27G-5
Dimensions (LxHxW)	420x187x140mm/ 16.54x7.36x5.51 in
Weight	0.76kg/1.68 lb

Note:
The testing standard of the product's luminous flux: Place the five lights on the same horizontal surface for testing, and the tested luminous flux is the accurate luminous flux.

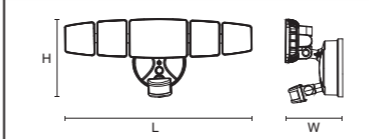

4

Operation Instructions

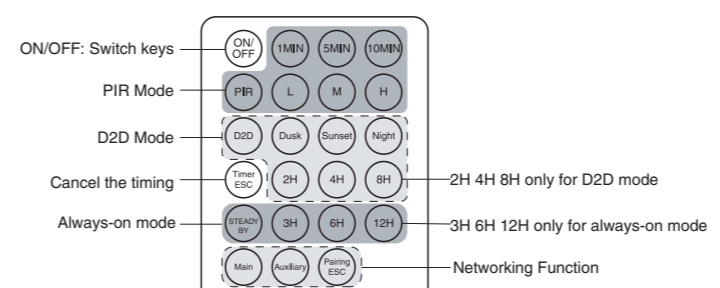

Remove the insulation sheet before using the remote control.

- Press PIR**
When the light flashes, it means the light receives the signal from the remote control and starts the body sensing mode. It will be in the test mode until you set the delay time and the sensing distance. Test mode:
When the light is in the test mode, it will be in sensing mode both day and night, and the sensing delay is 5 seconds. The test mode will not be ended until the delay time and the sensing distance is set. Note: Every time press RIP, the light will be in the test mode until you adjust the setting.
- Sensing delay**
Press 1MIN, the light flashes, start 1 minute delay —the light is on for 1 minute after sensing the motion. Press 5MIN, the light flashes, starts a 5-minute delay — the light is on for 5 minutes after sensing the motion. Press 10MIN, the light flashes, starts 10-minute delay — the light is on for 10 minutes after sensing the motion.
- Sensing distance adjustment**
Press L: Detection distance is 13-26ft
Press M: Detection distance is 26-49ft
Press H: Detection distance is 49-72ft
Note: The above sensing distance applies at an angle between the sensor and the horizontal plane between 0° and 45 degrees.



5

Operation Instructions

- D2D Mode**
The light sensor mode is activated, and it will automatically enter the sunset mode after flashing once.
- Illumination adjustment**
Press Sunset, the light automatically turns on every day at dusk after flashing once. Press Night, the light automatically turns on every day in the evening after flashing once. Press Night, the light automatically turns on every day at night after flashing once.
- Timing**
Press 2H, the light flashes once and turns off automatically after 2 hours. Press 4H, the light flashes once, and automatically turns off after 4 hours. Press 8H, the light flashes once and turns off automatically after 8 hours. Note: After the timer is set, it automatically cycles every day without the need to repeat the setting. The illumination mode does not change when the timing function is adjusted.
- Cancel the timing**
Press Timer ESC and, the timing function is canceled after flashing three times.

Always-on mode

- Press STEADY BY**
When the light enters the constant light mode after flashing once.
- Timing**
Press 3H, the light flashes once, and automatically turns off after 3 hours. Press 6H, the light flashes once, and automatically turns off after 6 hours. Press 12H, the light flashes once, and automatically turns off after 12 hours. Timer function needs to be reset each time the light is turned on.
- Cancel the timing**
Press Timer ESC, the timing function is canceled after flashing three times.

Networking Function Steps

- M (main) : Start to pair**
Press M, the main light waits to be paired, and flashes fast. (0.8S/cycle)
(Note: The light that accepts the command of the remote control will be used as the main light)
 - A (auxiliary): Auxiliary pairing**
Press A, the auxiliary light waits to be paired.
The pairing is successful, the light flashes 3 times and then goes out. (About 0.8S/cycle)
The pairing is unsuccessful, the light flashes slowly to maintain the search state. (About 2S/cycle)
 - Press M towards the main light, and it stops to flash. The networking completed.
- Exit networking settings**
E: Pairing ESC
Press E once for the light that needs to be unpaired, the light will exit the pairing mode.



6

Operation Instructions

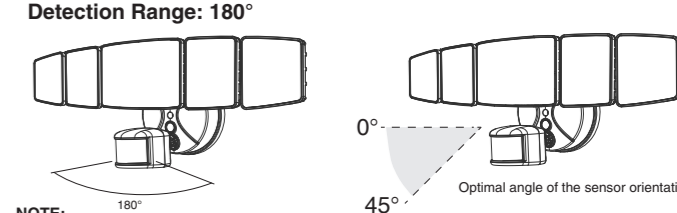

- NOTE:
1. The PIR sensor shall always be tilted slightly downward.
2. The orientation angle of the sensor shall be between 0-45°.

RECOMMENDED INSTALLATION HEIGHT: 6.5-13.1 feet above the ground.

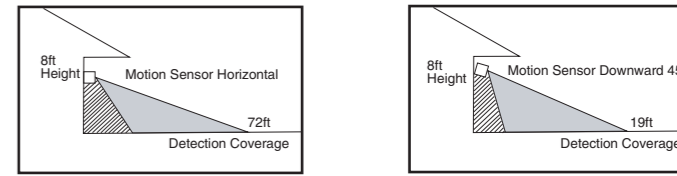

When mounted 8ft above the ground and the sensor is oriented horizontally, the maximum sensing distance is about 72ft.

When mounted 8ft above the ground and the sensor is 45° down, the minimum sensing distance is about 19ft.

Note: The detection distance of the sensor is the farthest when the ambient temperature is 25°C. Any temperature fluctuations above or below 25°C will affect the detection distance. If the light continues to detect motion while it is on, it will remain on until the motion stops.

The sensor will be more sensitive to motion across the motion towards it directly.

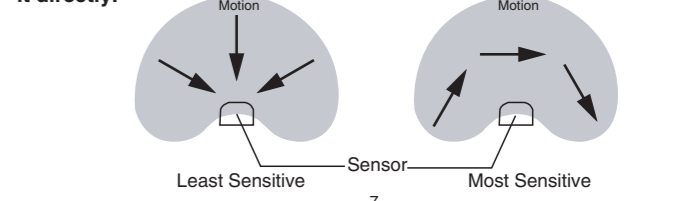

7

PREPARATION

NOTE:
Before beginning assembly of product, make sure all parts are present. Compare parts with parts list. If any part is missing or damaged, do not attempt to assemble the product. Estimated Assembly Time: 30-60 minutes.

Recommended to be installed on the ground above 2.5m (8.2 ft) and no higher than 5 m (16.4 ft).

Product appearance may vary from image shown.

TOOLS REQUIRED (not included)

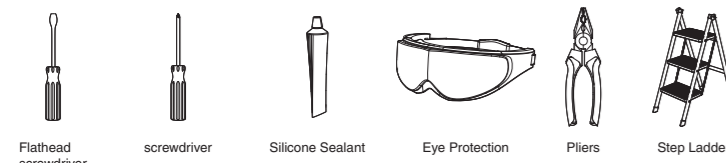

WARNING:
THIS PRODUCT MUST BE INSTALLED IN ACCORDANCE WITH THE APPLICABLE INSTALLATION CODE BY A PERSON FAMILIAR WITH THE CONSTRUCTION AND OPERATION OF THE PRODUCT AND THE HAZARDS INVOLVED.

CAUTION:
PLEASE MAKE SURE YOUR WALL SWITCH AND POWER AT MAIN CIRCUIT BREAKER BOTH ARE OFF.

IF IN DOUBT ABOUT ELECTRICAL INSTALLATION, CONSULT A LICENSED ELECTRICIAN.



8

PREPARATION

RISK OF SHOCK:
BEFORE BEGINNING INSTALLATION, TURN OFF ELECTRICITY AT THE CIRCUIT BREAKER BOX OR THE MAIN FUSE BOX.

NOTE:
BE SURE TO USE WIRE NUTS/CONNECTORS RATED FOR THE CORRECT GAUGE AND NUMBER OF WIRES USED.

MAKE SURE THERE ARE NO EXPOSED WIRE BUNDLES OUTSIDE THE WIRE NUT/CONNECTOR (IF APPLICABLE).
BE CAREFUL NOT TO DAMAGE OR CUT THE WIRE INSULATION (COVERING) DURING INSTALLATION. DO NOT LET THE WIRES TOUCH ANY SHARP EDGES.

WARNING:
DO NOT CONNECT THIS LIGHT FIXTURE TO AN UNGROUNDED ELECTRICAL SYSTEM. ATTACH GROUND FIXTURE WIRE TO EITHER GREEN GROUND SCREW ON MOUNTING PLATE OR THE GROUND WIRE IN THE OUTLET BOX.

INSTALLING THIS LIGHT IN AN UNGROUNDED ELECTRICAL SYSTEM MAY CAUSE THE METAL PARTS OF THE LIGHT TO CARRY CURRENT IF ANY WIRES OR WIRE CONNECTIONS ARE DAMAGED OR LOOSE. IN THIS CASE, ANYONE WHO TOUCHES THE LIGHT WILL RECEIVE AN ELECTRIC SHOCK, RESULTING IN INJURY OR DEATH.



9

INSTALLATION STEPS

FOR WET LOCATION, MAKE SURE FILL FULL THE GAP OF EVA GASKET AND MOUNTING SURFACE WITH SEALING COMPOUND OR SILICONE GLUE.

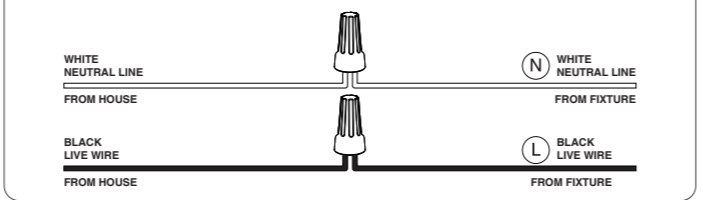
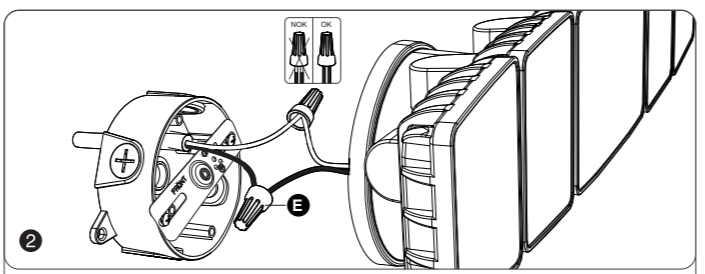
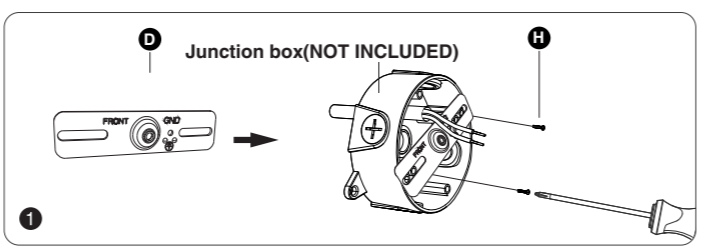

Note: The housing of this light is made of insulating material, which can be used safely without a ground wire.



10

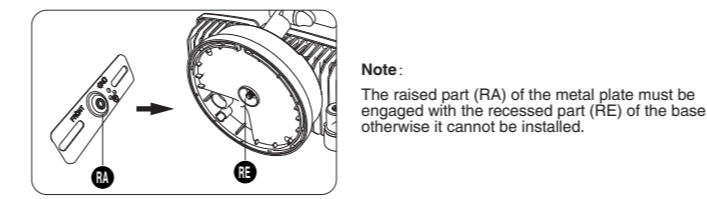
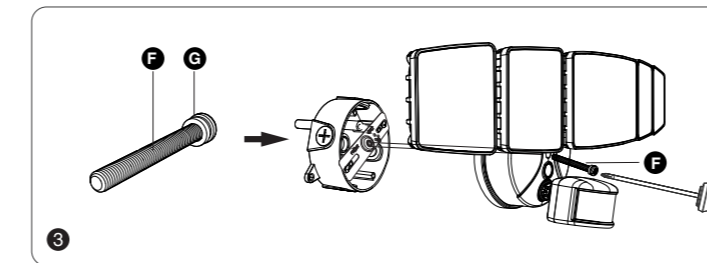

Note:
The raised part (RA) of the metal plate must be engaged with the recessed part (RE) of the base, otherwise it cannot be installed.

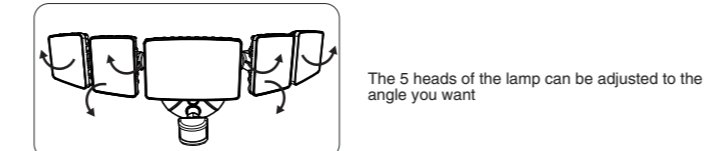

The 5 heads of the lamp can be adjusted to the angle you want



11

Troubleshooting

Malfunction	Cause	Remedy
LED senses a movement, the light does not light up	1. The light is not energized 2. Other surrounding light sources make the light misjudge it as daytime 3. During the day, the brightness is in night mode 4. Internal wiring is loose	1. Check power-on status 2. Turn off the nearby lights or sensor head to other directions 3. Reset 4. Rewiring after power failure
LED sensor light did not go out, continued to light up	Continuous movement within the sensing range	Check the relevant area and return or override the sensor head if necessary
LED sensor light illuminates during the day	The shadows around the sensor make it mistakenly think it's night	1. Do not cover the sensor head 2. Place the light in a place where the light is bright enough during the day
LED sensor light flashing	Surrounded by other unstable light sources shining onto the induction	Avoid being exposed to such light sources
LED lights turn on unexpectedly	1. Wind blows the branches and bushes within the sensing range 2. Sensing cars on the road 3. Sudden temperature change due to climate factors or fans, exhaust from open windows	1. Adjust its scope 2. Adjust its scope 3. Change irradiation area



12

REPLACE THE BATTERIES

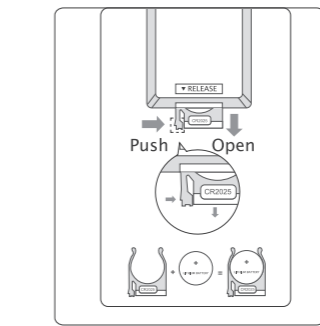

Replace the batteries of the remote control by referring to the figure on the right.

FCC Warning:
Any Changes or modifications not expressly approved by the party responsible for compliance could void the user's authority to operate the equipment.
This device complies with part 15 of the FCC Rules. Operation is subject to the following two conditions:
(1) This device may not cause harmful interference, and
(2) this device must accept any interference received, including interference that may cause undesired operation.
Note: This equipment has been tested and found to comply with the limits for a Class B digital device, pursuant to part 15 of the FCC Rules. These limits are designed to provide reasonable protection against harmful interference in a residential installation. This equipment generates uses and can radiate radio frequency energy and, if not installed and used in accordance with the instructions, may cause harmful interference to radio communications. However, there is no guarantee that interference will not occur in a particular installation. If this equipment does cause harmful interference to radio or television reception, which can be determined by turning the equipment off and on, the user is encouraged to try to correct the interference by one or more of the following measures:
-Reorient or relocate the receiving antenna.
-Increase the separation between the equipment and receiver.
-Connect the equipment into an outlet on a circuit different from that to which the receiver is connected.
-Consult the dealer or an experienced radio/TV technician for help.

HK Bright International Lighting Co., Limited
Unit 618, 6/F., Kam Teem Industrial Building, 135
Connaught Road West, Sai Wan Hong Hong
Manufacturer/Hersteller: MDH LIGHTING LTD
Suite 302, 292 Strovolos Avenue, 2048 Strovolos Nicosia,
Cyprus
UK importer: MDH LIGHTING LTD
69 Aberdeen Avenue, Cambridge CB2 8DL,
United Kingdom
Made in China

support@onforuled.com www.onforuled.com



13