

LED WALL LAMP

Product Manual

- MODEL: BDB55-3 BDJ55-3 BDL40-3
 BDI45-2 BDC80-3 BDD100-3
 BDB100-3 BDB36-3



COMPONENTS AND STRUCTURE

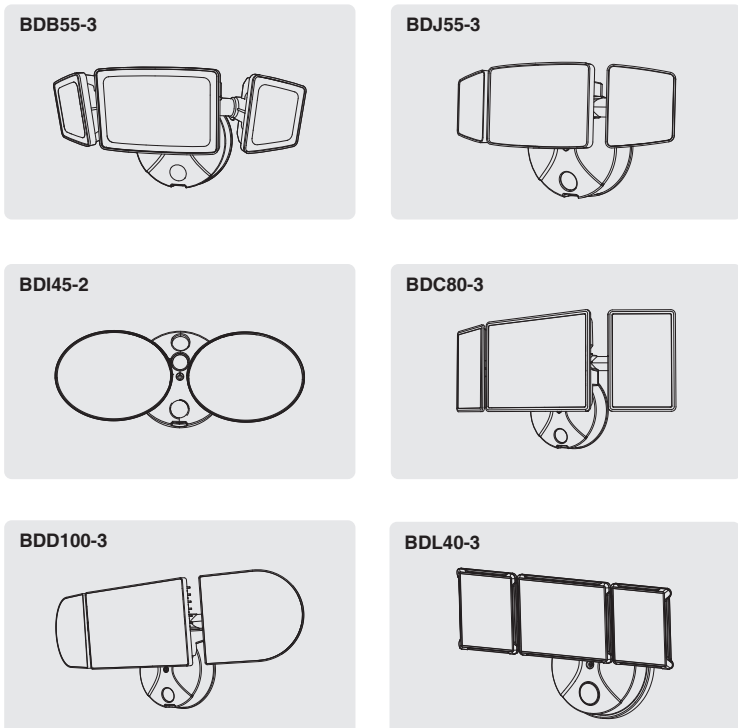

COMPONENTS AND STRUCTURE

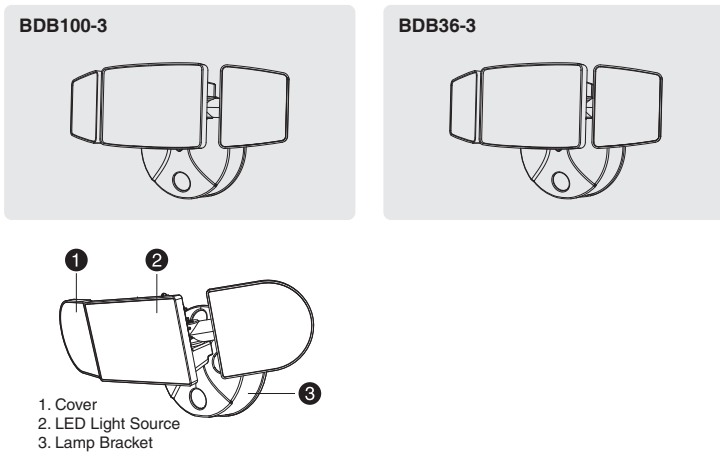

1. Cover
2. LED Light Source
3. Lamp Bracket

PARTS LIST

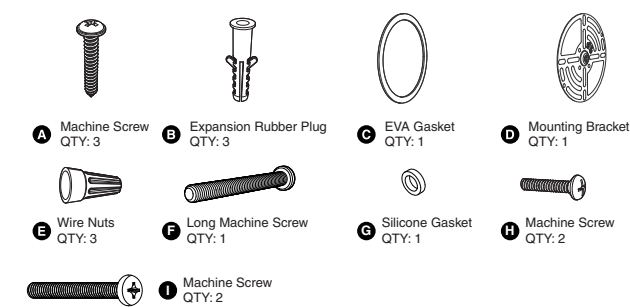

SPECIFICATIONS

LED WALL LAMP				
Model	BDB55-3	BDJ55-3	BDI45-2	BDC80-3
Input Voltage	100-120V ~ 60Hz			
Input Current	0.5A	0.5A	0.38A	0.58A
Rated Power	55W	55W	45W	70W
Luminous Flux	5500lm	5500lm	4000lm	6200lm
Model	BDD100-3	BDL40-3	BDB100-3	BDB36-3
Input Voltage	100-120V ~ 60Hz			
Input Current	0.83A	0.35A	0.83A	0.3A
Rated Power	100W	40W	100W	36W
Luminous Flux	9000lm	4000lm	9000lm	3600lm
CCT	6500K			
CRI	≥80			
Power Factor	≥0.9			
L70B50 lifetime	30000hours L70B50 @ 25°			
Beam Angle	120°			
°a	-20-40°C/-4°F-104°F			
Luminaire Location	SUITABLE FOR WET LOCATIONS			



SPECIFICATIONS

DIMENSIONS			
Model	BDB55-3	BDJ55-3	BDI45-2
Dimensions (LxHxW)	272x123x121mm/ 10.71x4.84x4.76 in	270x152x109 mm/ 10.63x5.98x4.29 in	256x140x145 mm/ 10.08x5.5x5.7 in
Weight	0.67 kg/1.48 lb	0.67 kg/1.48 lb	0.66 kg/1.46 lb
Model	BDC80-3	BDD100-3	BDL40-3
Dimensions (LxHxW)	365x195x118 mm/ 14.4x7.67x4.64 in	455x182x120 mm/ 17.9x7.16x4.72 in	279x136x118 mm/ 10.98x5.35x4.64 in
Weight	0.92 kg/2.03 lb	1.45 kg/3.2 lb	0.68 kg/1.5 lb
Model	BDB100-3	BDB36-3	
Dimensions (LxHxW)	389x178x120mm/ 15.3x7.0x4.7 in	272x160x120mm/ 10.71x6.3x4.72 in	
Weight	0.98 kg/2.16 lb	0.48 kg/1.06 lb	

Note:
The testing standard of the product's luminous flux. Place the three lights on the same horizontal surface for testing, and the tested luminous flux is the accurate luminous flux.

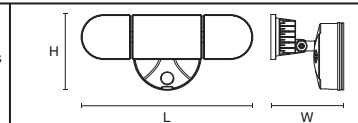

PREPARATION

NOTE:

Before beginning assembly of product, make sure all parts are present. Compare parts with parts list. If any part is missing or damaged, do not attempt to assemble the product. Estimated Assembly Time: 30-60 minutes.

Recommended to be installed on the ground above 2.5m (8.2 ft) and no higher than 5 m (16.4 ft).

Product appearance may vary from image shown.

TOOLS REQUIRED (not included)

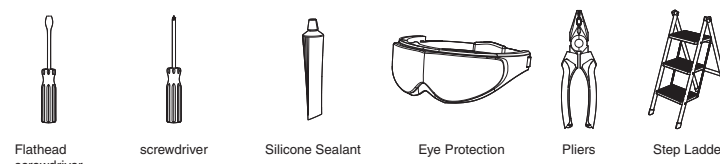

WARNING:

THIS PRODUCT MUST BE INSTALLED IN ACCORDANCE WITH THE APPLICABLE INSTALLATION CODE BY A PERSON FAMILIAR WITH THE CONSTRUCTION AND OPERATION OF THE PRODUCT AND THE HAZARDS INVOLVED.

CAUTION:

PLEASE MAKE SURE YOUR WALL SWITCH AND POWER AT MAIN CIRCUIT BREAKER BOTH ARE OFF.

IF IN DOUBT ABOUT ELECTRICAL INSTALLATION, CONSULT A LICENSED ELECTRICIAN.



PREPARATION

RISK OF SHOCK:

BEFORE BEGINNING INSTALLATION, TURN OFF ELECTRICITY AT THE CIRCUIT BREAKER BOX OR THE MAIN FUSE BOX.

NOTE:

BE SURE TO USE WIRE NUTS/CONNECTORS RATED FOR THE CORRECT GAUGE AND NUMBER OF WIRES USED.

MAKE SURE THERE ARE NO EXPOSED WIRE BUNDLES OUTSIDE THE WIRE NUT/CONNECTOR (IF APPLICABLE).

BE CAREFUL NOT TO DAMAGE OR CUT THE WIRE INSULATION (COVERING) DURING INSTALLATION. DO NOT LET THE WIRES TOUCH ANY SHARP EDGES.

WARNING:

DO NOT CONNECT THIS LIGHT FIXTURE TO AN UNGROUNDED ELECTRICAL SYSTEM. ATTACH GROUND FIXTURE WIRE TO EITHER GREEN GROUND SCREW ON MOUNTING PLATE OR THE GROUND WIRE IN THE OUTLET BOX.

INSTALLING THIS LIGHT IN AN UNGROUNDED ELECTRICAL SYSTEM MAY CAUSE THE METAL PARTS OF THE LIGHT TO CARRY CURRENT IF ANY WIRES OR WIRE CONNECTIONS ARE DAMAGED OR LOOSE. IN THIS CASE, ANYONE WHO TOUCHES THE LIGHT WILL RECEIVE AN ELECTRIC SHOCK, RESULTING IN INJURY OR DEATH.



INSTALLATION STEPS

FOR WET LOCATION, MAKE SURE FILL FULL THE GAP OF EVA GASKET AND MOUNTING SURFACE WITH SEALING COMPOUND OR SILICONE GLUE.

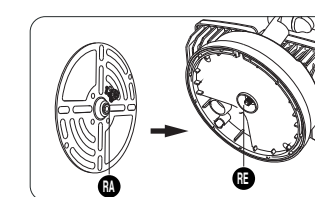
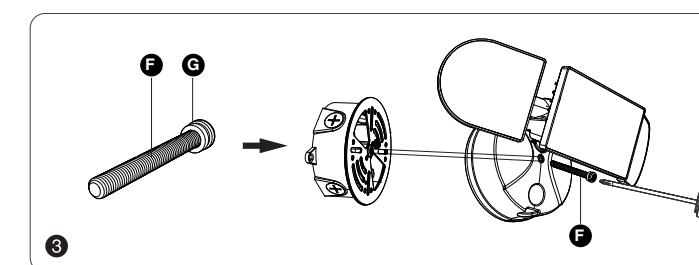
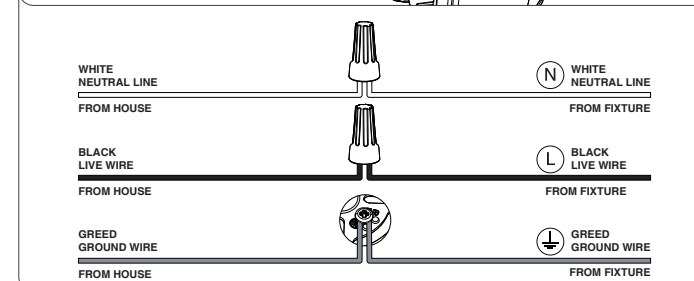
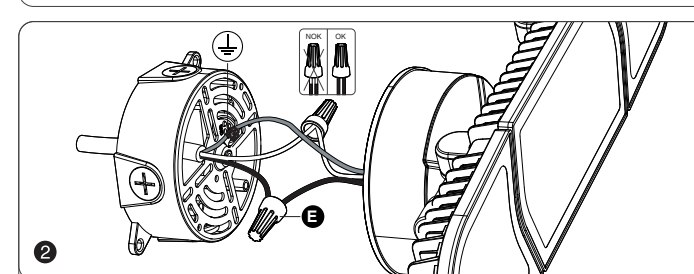
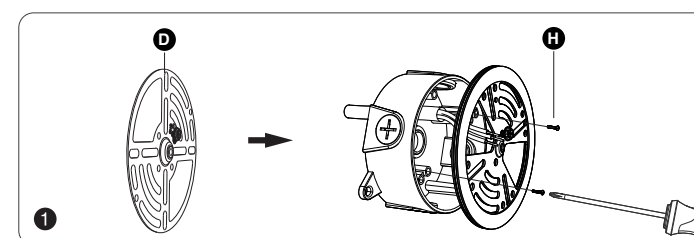

Note:
The raised part (RA) of the metal plate must be engaged with the recessed part (RE) of the base, otherwise it cannot be installed.



HK Bright International Lighting Co., Limited
Unit 616, 6/F., Kam Teem Industrial Building, 135
Connaught Road West, Sai Wan Hong Kong
Manufacturer/Hersteller: MDH LIGHTING LTD
Suite 302, 292 Strovolos Avenue, 2048 Strovolos Nicosia,
Cyprus

UK Importer: MDH LIGHTING LTD
69 Aberdeen Avenue, Cambridge CB2 8DL,
United Kingdom

Made in China

✉ support@onforuled.com 🌐 www.onforuleds.com

