

SOLE

FITNESS

E98 ELLIPTICAL OWNER'S MANUAL



PLEASE CAREFULLY READ THIS ENTIRE MANUAL BEFORE OPERATING YOUR NEW ELLIPTICAL

TABLE OF CONTENTS

| | |
|----------------------------------|----|
| Product Registration | 1 |
| Important Safety Instructions | 2 |
| Important Electrical Information | 3 |
| Important Operation Instructions | 4 |
| Transport Instructions | 4 |
| E98 Assembly Instructions | 7 |
| Elliptical Features | 12 |
| Operation of Your New Elliptical | 13 |
| Programmable Features | 16 |
| Using Heart Rate Monitor | 22 |
| General Maintenance | 24 |
| Manufacturer's Limited Warranty | 25 |

ATTENTION

THIS ELLIPTICAL IS INTENDED FOR **RESIDENTIAL USE ONLY** AND IS WARRANTED FOR THE APPLICATION. ANY OTHER APPLICATION **VOIDS** THIS WARRANTY IN ITS ENTIRETY.

SOLE

FITNESS

CONGRATULATIONS ON YOUR NEW ELLIPTICAL AND WELCOME TO THE SOLE FAMILY!

Thank you for your purchase of this quality elliptical trainer from **SOLE**. Your new elliptical has been manufactured by one of the leading fitness manufacturers in the world and is backed by one of the most comprehensive warranties available. **SOLE** will do all we can to make your ownership experience as pleasant as possible for many years to come.

If you have any questions about your new product or questions about the warranty contact **SOLE** Fitness at **1-866-780-SOLE (7653)**. If you have a technical problem with your new elliptical contact **SOLE** technical service at **866-MYSOLE1 (697-6531)**.

Please take a moment at this time to record below the name of the dealer, their telephone number, and the date of purchase for easy contact in the future. We appreciate your confidence in **SOLE** and we will always remember that you are the reason that we are in business. Please complete and mail your registration card today and enjoy your new elliptical.

Yours in Health,
SOLE Fitness

Name of Dealer _____

Telephone Number of Dealer _____

Purchase Date _____

PRODUCT REGISTRATION

RECORD YOUR SERIAL NUMBER

Please record the Serial Number of this fitness product in the space provided below.

Serial Number _____

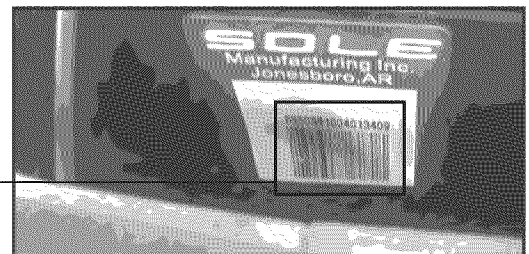

REGISTER YOUR PURCHASE

The self-addressed product registration card must be completed in full and returned to **SOLE**. You can also go to **www.soleellipticals.com** under the support tab to register online.

E98_20101230

IMPORTANT SAFETY INSTRUCTIONS

WARNING - Read all instructions before using this appliance.

DANGER - To reduce the risk of electric shock disconnect your SOLE elliptical from the electrical outlet prior to cleaning and/or service work.

WARNING - To reduce the risk of burns, fire, electric shock, or injury to persons, install the elliptical on a flat level surface with access to a 110-volt, 15-amp grounded outlet with only the elliptical plugged into the circuit.

DO NOT USE AN EXTENSION CORD UNLESS IT IS A 14AWG OR BETTER, WITH ONLY ONE OUTLET ON THE END: DO NOT ATTEMPT TO DISABLE THE GROUNDED PLUG BY USING IMPROPER ADAPTERS, OR IN ANY WAY MODIFY THE CORD SET.

A serious shock or fire hazard may result along with computer malfunctions. See Grounding Instructions, page 3.

- Do not operate elliptical on deeply padded, plush or shag carpet. Damage to both carpet and elliptical may result.
- Keep children away from the elliptical. There are obvious pinch points and other caution areas that can cause harm.
- Keep hands away from all moving parts.
- Never operate the elliptical if it has a damaged cord or plug. If the elliptical is not working properly, call your dealer.
- Keep the cord away from heated surfaces.
- Do not operate where aerosol spray products are being used or where oxygen is being administered. Sparks from the motor may ignite a highly gaseous environment.
- Never drop or insert any object into any openings.
- Do not use outdoors.
- To disconnect, turn all controls to the off position, then remove the plug from the outlet.
- Do not attempt to use your elliptical for any purpose other than for the purpose it is intended.
- The hand pulse sensors are not medical devices. Various factors, including the user's movement, may affect the accuracy of heart rate readings. The pulse sensors are intended only as exercise aids in determining heart rate trends in general.
- Wear proper shoes. High heels, dress shoes, sandals or bare feet are not suitable for use on your elliptical. Quality athletic shoes are recommended to avoid leg fatigue.

SAVE THESE INSTRUCTIONS - THINK SAFETY!

IMPORTANT ELECTRICAL INSTRUCTIONS

WARNING!

NEVER remove any cover without first disconnecting AC power.

If voltage varies by ten percent (10%) or more, the performance of your elliptical may be affected. **Such conditions are not covered under your warranty.** If you suspect the voltage is low, contact your local power company or a licensed electrician for proper testing.

NEVER expose this elliptical to rain or moisture. This product is **NOT** designed for use outdoors, near a pool or spa, or in any other high humidity environment. The operating temperature specification is 40 to 120 degrees Fahrenheit, and humidity is 95% non-condensing (no water drops forming on surfaces).

GROUNDING INSTRUCTIONS

This product must be grounded. If the elliptical should malfunction or breakdown, grounding provides a path of least resistance for electric current, reducing the risk of electric shock. This product is equipped with a cord having an equipment-grounding plug. The plug must be plugged into an appropriate outlet that is properly installed and grounded in accordance with all local codes and ordinances.

DANGER - Improper connection of the equipment-grounding conductor can result in a risk of electric shock. Check with a qualified electrician or serviceman if you are in doubt as to whether the product is properly grounded. Do not modify the plug provided with the product if it will not fit the outlet; have a proper outlet installed by a qualified electrician.

This product is for use on a nominal 110-volt circuit, and has a grounding plug that looks like the plug illustrated below. A temporary adapter that looks like the adapter illustrated below may be used to connect this plug to a 2-pole receptacle as shown below if a properly grounded outlet is not available. The temporary adapter should be used only until a properly grounded outlet, (shown below) can be installed by a qualified electrician. The green colored rigid ear-lug, or the like, extending from the adapter, must be connected to a permanent ground such as a properly grounded outlet box cover. Whenever the adapter is used, it must be held in place by a metal screw.

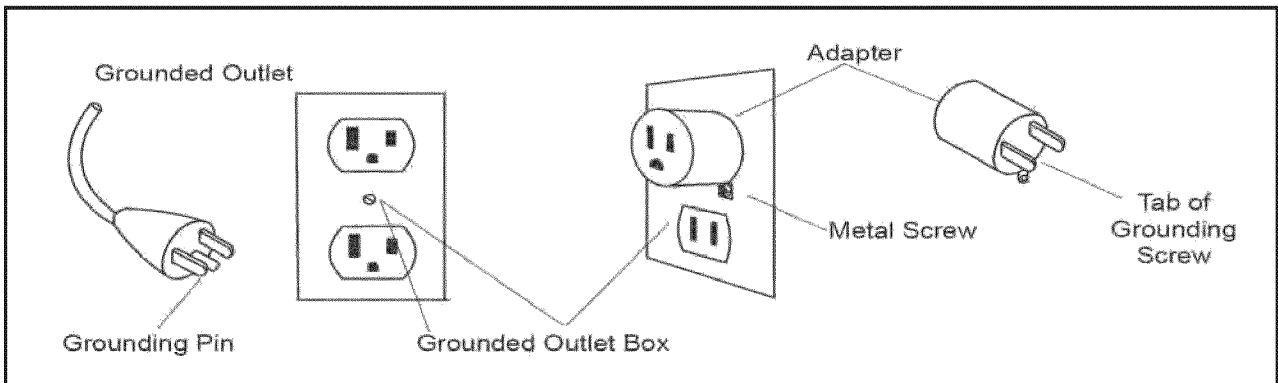

IMPORTANT OPERATION INSTRUCTIONS

- **NEVER** operate this elliptical without reading and completely understanding the results of any operational change you request from the computer.
- Understand that changes in resistance and incline do not occur immediately. Set your desired resistance on the computer console and release the adjustment key. The computer will obey the command gradually.
- **NEVER** use your elliptical during an electrical storm. Surges may occur in your facility or household power supply that could damage elliptical components. Unplug the elliptical during an electrical storm as a precaution.
- Use caution while participating in other activities while pedaling on your elliptical; such as watching television, reading, etc. These distractions may result in serious injury.
- Always hold on to a handrail or hand bar while making control changes (incline, resistance, etc.).
- Do not use excessive pressure on console control keys. They are precision set to function properly with little finger pressure. Pushing harder is not going to make the unit go faster or slower. If you feel the buttons are not functioning properly with normal pressure contact your **SOLE** dealer.

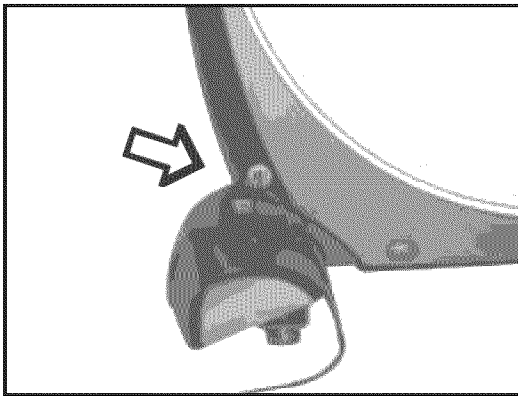

POWER CONNECTOR - FRONT, LEFT SIDE OF UNIT

TRANSPORT INSTRUCTIONS

The elliptical is equipped with two transport wheels which are engaged when the rear of the elliptical is lifted.

E98 ASSEMBLY PACK CHECKLIST

1

HARDWARE STEP 1

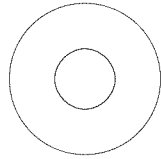

#158. 3/8" x 19 x 1.5T
Flat Washer (2 pcs)

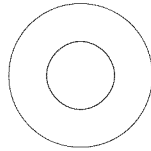

#154. 5/16" x 20 x 1.5T
Flat Washer (4 pcs)

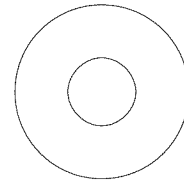

#164. 3/8" x 23 x 2T
Curved Washer (2 pcs)

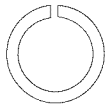

#167. 3/8" x 2T
Split Washer (1 pc)

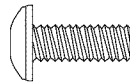

#128. M5 x 10mm
Phillips Head Screw (4 pcs)



#145. 3/8" x 7T
Nylloc Nut (2 pcs)



#166. 5/16" x 1.5T
Split Washer (4 pcs)



#168. 5/16"
Star Washer (4 pcs)

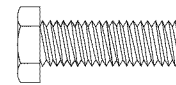

#116. 3/8" x 3/4"
Hex Head Bolt (2 pcs)

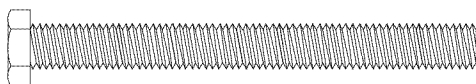

#115. 5/16" x 2-1/4"
Hex Head Bolt (4 pcs)

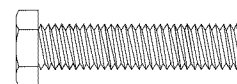

#117. 3/8" x 1-1/2"
Hex Head Bolt (2 pcs)

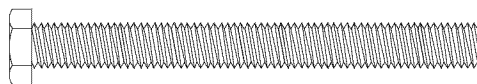

#118. 3/8" x 2-1/4"
Hex Head Bolt (1 pc)

2 HARDWARE STEP 2

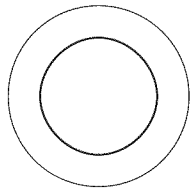

#163. 25mm
Wave Washer (4 pcs)

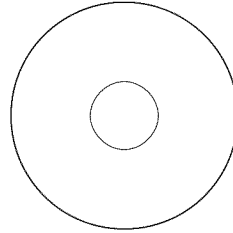

#160. 3/8" x 30 x 2T
Flat Washer (2 pcs)

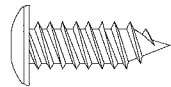

#132. 3.5 x 12mm
Sheet Metal Screw (8 pcs)

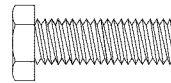

#116. 3/8" x 3/4"
Hex Head Bolt (2 pcs)

3 HARDWARE STEP 3

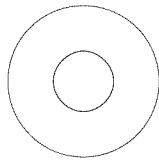

#154. 5/16" x 20 x 1.5T
Flat Washer (2 pcs)



#143. 5/16" x 7T
Nyloc Nut (2 pcs)

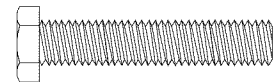

#114. 5/16" x 1-1/4"
Hex Head Bolt (2 pcs)

4 HARDWARE STEP 4

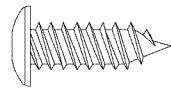

#132. 3.5 x 12mm
Sheet Metal Screw (10 pcs)

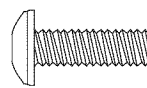

#129. M5 x 15mm
Phillips Head Screw (29 pcs)

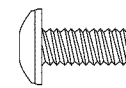

#131. M6 x 10mm
Phillips Head Screw (4 pcs)

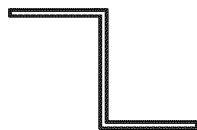

#20. Bracket (2 pcs)

ASSEMBLY TOOLS

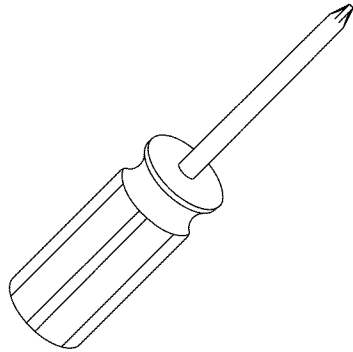

#171. Phillips Head Screwdriver

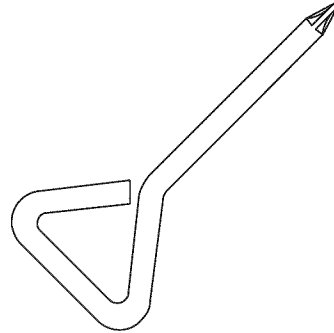

#170. Short Phillips Head Screwdriver

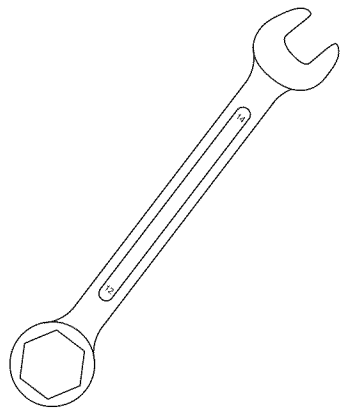

#187. 12/14mm Wrench

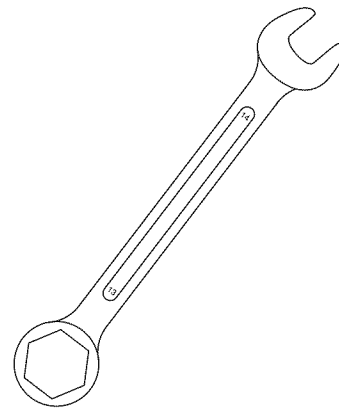

#169. 13/14mm Wrench

E98 ASSEMBLY INSTRUCTIONS

PRE-ASSEMBLY

1. Using a razor knife (Box Cutter) cut the outside, bottom, edge of box along the dotted line. Lift Box over the unit and unpack.
2. Carefully remove all parts from carton and inspect for any damage or missing parts. If damaged parts are found, or parts are missing, contact your dealer immediately.
3. Locate the hardware package. Remove the tools first. Remove the hardware for each step as needed to avoid confusion. The numbers in the instructions that are in parenthesis (#) are the item number from the assembly drawing for reference.

1 INCLINE RAIL & CONSOLE MAST

1. Install the Incline Rail Assembly (2) into the U-channel bracket of the Main Frame (1). Secure with the six bolts & associated hardware as follows: From the sides install two Hex Head Bolts (117) with two Flat Washers (158) and two Nylon Nuts (145). From the top install four Hex Head Bolts (115), four Split Washers (166), four Flat Washers (154), and four Star Washers (168), and tighten with the Wrenches provided (169 & 187).
2. Connect the three Incline Motor Power lines by matching the Red, White and Black color codes of the wires (43) and the 3-pin position Sensor Connector (44). Locate the Console Mast (12) and Console Mast Cover (83) and slide the Cover onto the Mast as far as it will go. Make sure the Console Mast Cover is facing the correct way. At the top opening of the Main Frame of the elliptical is a Computer Cable (45); Secure the free end of the twist tie that exits the bottom of the console mast (12) to this cable. Pull the opposite end of this twist tie up through the console mast (12) until the cable exits the top. Install the Console Mast (12) into the receiving bracket on the top of the Main Frame (1). Pull slightly on the computer cable at the top of the mast while installing. This will ensure the cable does not get pinched and shorted during console mast assembly.
3. Put one Split Washer (167) onto the Long Hex Head Bolt (118) and install through the left side of the receiving bracket into the Console Mast (12). Put the two Curved Washers (164) onto the two Short Hex Head Bolts (116) and install through the front of the console mast. Using Wrench (184), tighten the (116) bolts first, then the (118) bolt, and lastly the fourth bolt, which is pre-installed, firmly. These bolts should be tightened as much as you possibly can. This is the main joint of the unit. If not tightened sufficiently, this could lead to noise and instability issues.
4. Plug the Computer Cable (45) and two Hand pulse Cables (52 & 56) into the back of the console. Secure the Console (40) on the console mounting plate with four Phillips Head Screws (128).

HARDWARE STEP 1

- #158. 3/8" x 19 x 1.5T Flat Washer (2 pcs)
- #154. 5/16" x 20 x 1.5T Flat Washer (4 pcs)
- #164. 3/8" x 23 x 2T Curved Washer (2 pcs)
- #167. 3/8" x 2T Split Washer (1 pc)
- #128. M5 x 10mm Phillips Screw (4 pcs)
- #145. 3/8" x 7T Nylon Nut (2 pcs)
- #166. 5/16" x 1.5T Split Washer (4 pcs)
- #168. 5/16" Star Washer (4 pcs)
- #116. 3/8" x 3/4" Hex Head Bolt (2 pcs)
- #115. 5/16" x 2-1/4" Hex Head Bolt (4 pcs)
- #117. 3/8" x 1-1/2" Hex Head Bolt (2 pcs)
- #118. 3/8" x 2-1/4" Hex Head Bolt (1 pc)

2 HANDLEBAR

1. Install two Washers (163) onto the Left and Right sides of the Handle Bar axle.
2. Slide the Left (10) and Right (11) Handle Bars onto the appropriate side of the axle. The handlebars have a small sticker on them indicating L (left) and R (right). *Make sure the handlebars are facing the correct direction – see illustration.*
3. Install two Flat Washers (160) onto the two Hex Head Bolts (116). Insert and and tighten in the threaded holes at the ends of each axle.
4. Install the Handle Bar Covers (91 to 92) and (93 to 94) over the Console Mast axle connections and secure with the eight Sheet Metal Screws (132).

HARDWARE STEP 2

- #163. 25mm Wave Washer (4 pcs)
- #160. 3/8" x 30 x 2T Flat Washer (2 pcs)
- #132. 3.5 x 12mm Sheet Metal Screw (8 pcs)
- #116. 3/8" x 3/4" Hex Head Bolt (2 pcs)

1 ASSEMBLY STEP 1

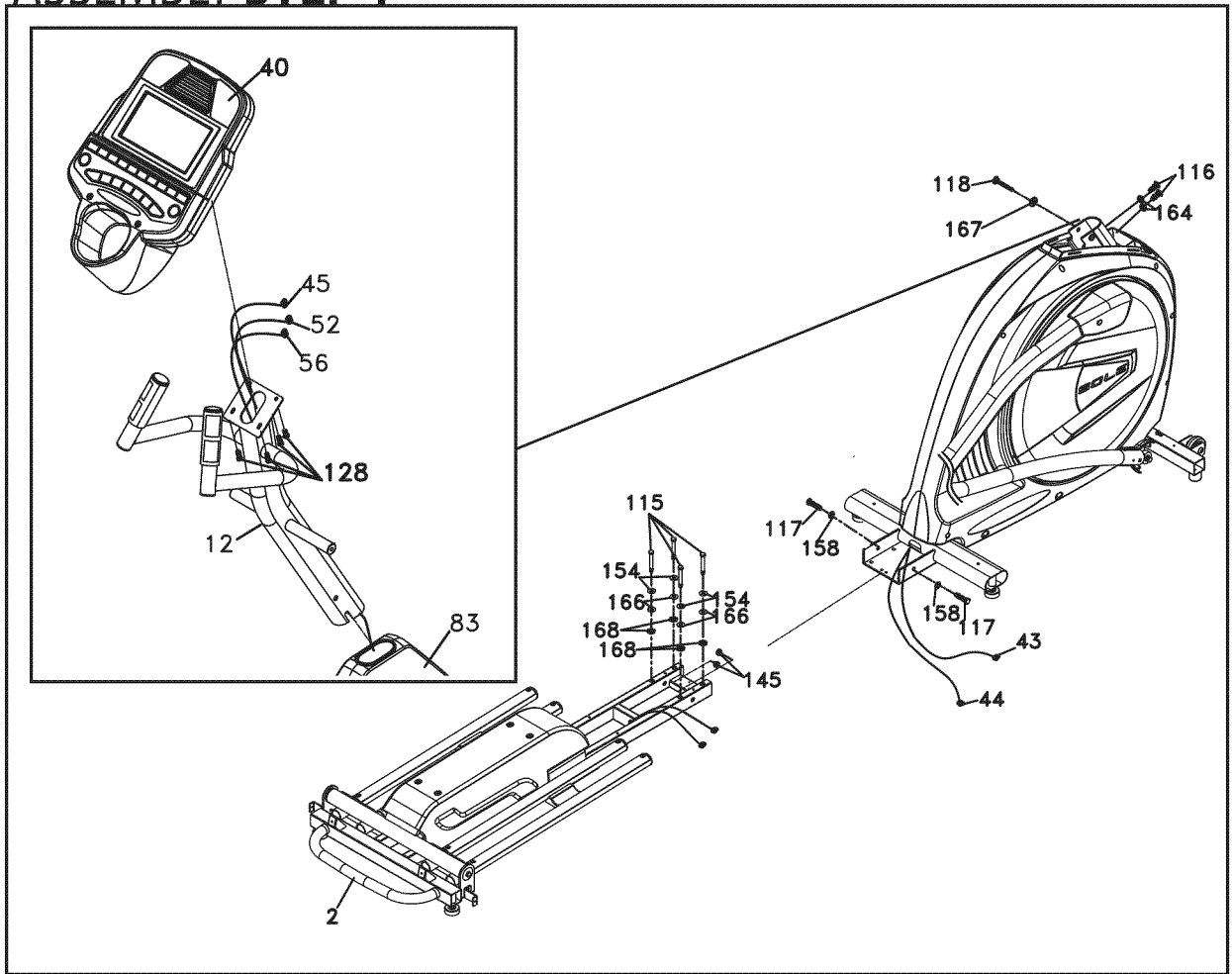

2 ASSEMBLY STEP 2

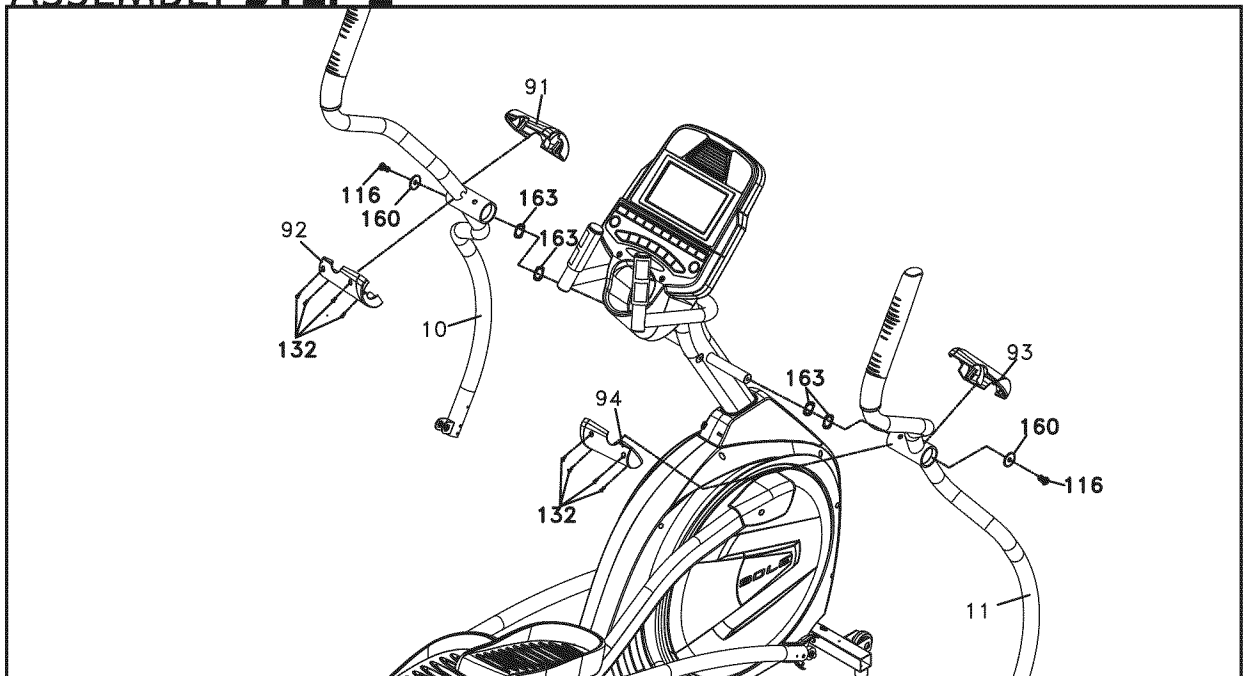

3 CONNECTING ARM

1. Untie the wire holding the Sleeve Spacer (19) in place on the rod-end bushings, located on the ends of the connecting arms (8 & 9). Align the hole in the rod ends with the hole in the brackets of the left and right Handle Bar (10 & 11). The rod end should be on the inside of the Handle Bar bracket. Secure both sides with a Hex Head Bolt (114), Flat Washer (154) and Nyloc Nut (143) by using the wrenches provided (169 & 187).

HARDWARE STEP 3

#154. 5/16" x 20 x 1.5T
Flat Washer (2 pcs)
#143. 5/16" x 7T
Nyloc Nut (2 pcs)
#114. 5/16" x 1-1/4"
Hex Head Bolt (2 pcs)

4 PLASTIC PARTS

1. Match up the console covers (81 & 82) and secure with three Phillips head screws (129) and two Sheet Metal Screws (132) using the short Phillips head screw driver (170). Tighten the Sheet metal screws first.
2. Match up the Connecting Arm Covers (97 & 98-inner covers and 95 & 96 -outer covers). Install the inner covers onto the Left and Right Connecting Arms (8 & 9) and secure each side with two Phillips Head Screws (129) and two Sheet Metal Screws (132) by using the Short Phillips Head Screw Driver (170). Install the outer covers onto the left and right handlebars (10 & 11) and secure each side with two Phillips Head Screws (129) and two Self Tapping Screws (132). Make sure the outer covers are positioned in relation to the arrow on each sticker.
3. Install Sliding Wheel Covers (22) on each side and secure with four Phillips Head Screws (129).
4. Install the two Stabilizer Covers (101 & 102) on the middle stabilizer bar with two Phillips Head Screws (129).
5. Install the Front Stabilizer Cover (90) on the front stabilizer with two Phillips Head Screws (129).
6. Install the two incline Cover brackets (20), with the hole for mounting the plastic cover on the bent tab facing rearward, and secure them on the Incline Rail Assembly (2) with four Phillips Head Screws (131). Install the Rear incline bar cover (100) on the rail base with two Screws (129).
7. Install the Rear Stabilizer Cover (24) on the Rear Stabilizer with four Phillips Head Screws (129).
8. This step to be performed after the elliptical power is plugged in. Run the incline to position 8 and install the incline Rail front cover (99) up against the middle stabilizer tube with four Phillips Head Screws (129).

HARDWARE STEP 4

#132. 3.5 x 12mm Sheet
Metal Screw (10 pcs)
#129. M5 x 15mm
Phillips Head Screw
(29 pcs)
#131. M6 x 10mm
Phillips Head Screw
(4 pcs)
#20. Bracket (2 pcs)

3 ASSEMBLY STEP 3

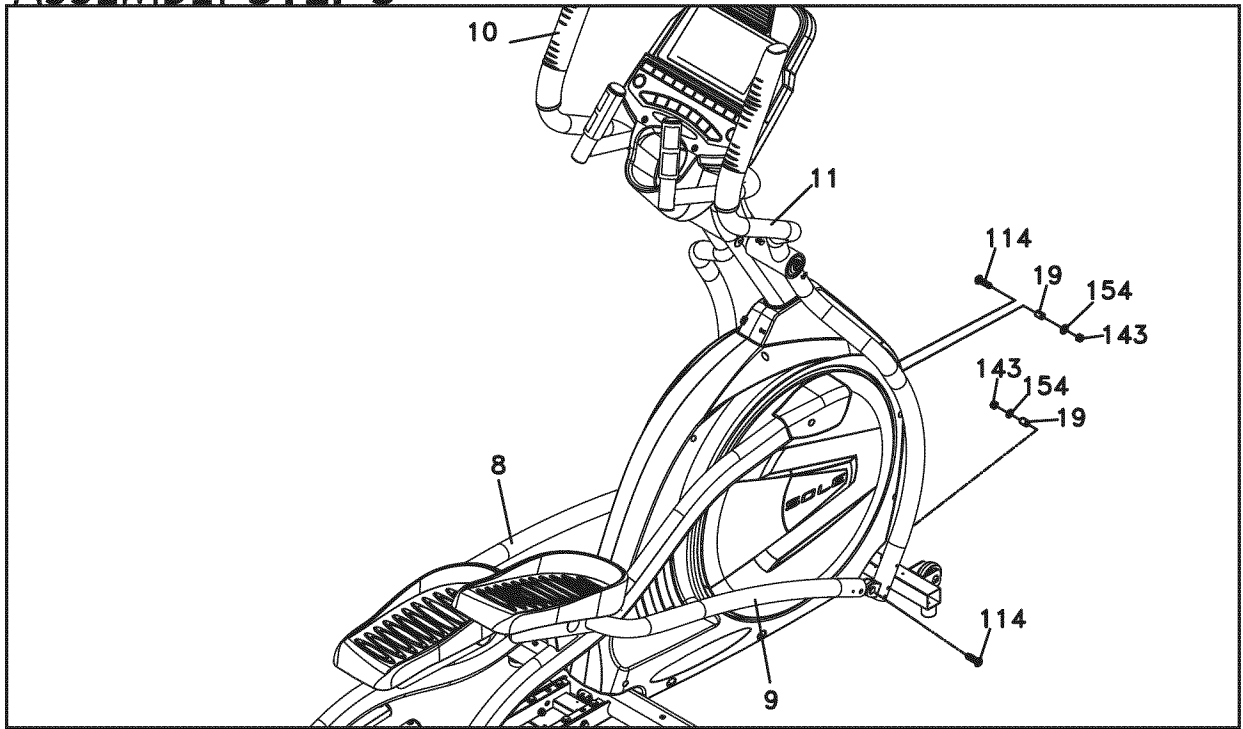

4 ASSEMBLY STEP 4

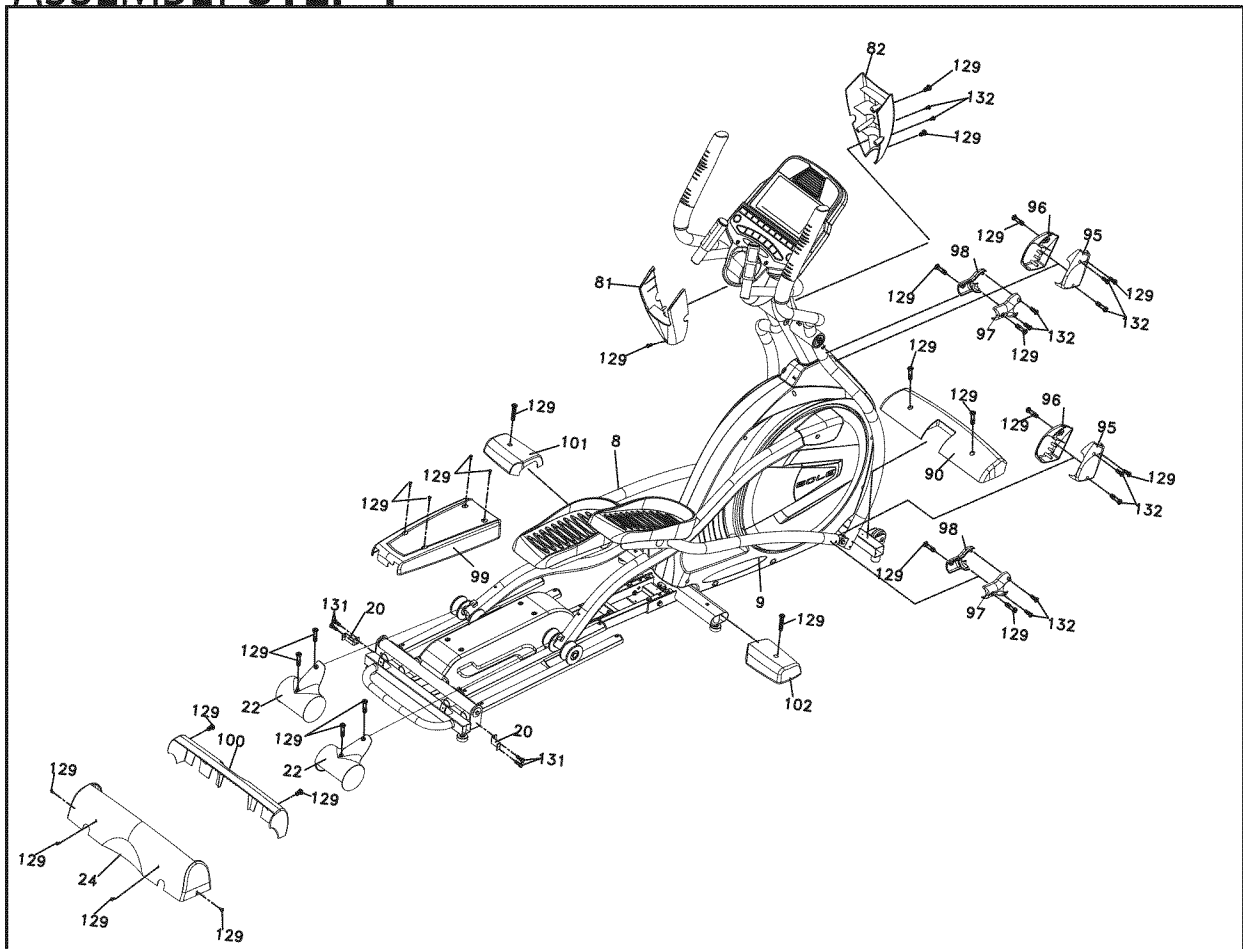

ELLIPTICAL FEATURES

CORRECTLY ALIGNED ORTHOPEDIC FOOT PADS

Through research performed with a leading sports scientist and physical rehabilitation expert; SOLE engineering has developed a breakthrough in pedal design. No other elliptical, at any price, offers this unique feature. The history of elliptical use over the past few years tells us that many users suffer from numb toes while working out on elliptical trainers. Many other users complain of ankle, Achilles tendon, knee and/or hip pain. While researching a solution to these common problems SOLE engineers consulted Richard DeKok, P.T., M.T.C., of St. Bernard's Industrial Rehabilitation Center in Jonesboro Arkansas. Together we identified the inherent problem in elliptical designs and developed a solution to solve the problem. What we found is that when you use an elliptical you tend to push outward during the power stroke and not just straight back. This causes stress on the outer part of the foot and throws off the natural alignment of the joints. Our solution was simple but effective:

- We added a 2-degree inward angle to the footpads. This might sound simple but what it does is puts the users joints back into a neutral alignment. This eases the over stressing of the ankles, knees and hips.

RAMP INCLINE ADJUSTMENT

The E98 has an incline feature that will further increase the variety of your workouts. When the incline is at its lowest position you get a normal elliptical workout. As the incline increases you will feel your knees rise higher with each step; which means you are involving more muscle fibers, due to the increased range of motion.

The E98 has a computer controlled power incline. The power incline is controlled by buttons on the console and will automatically adjust via the incline motor during the built-in workout program.

OPERATION OF YOUR ELLIPTICAL

GETTING FAMILIAR WITH THE CONTROL PANEL

E98 CONSOLE

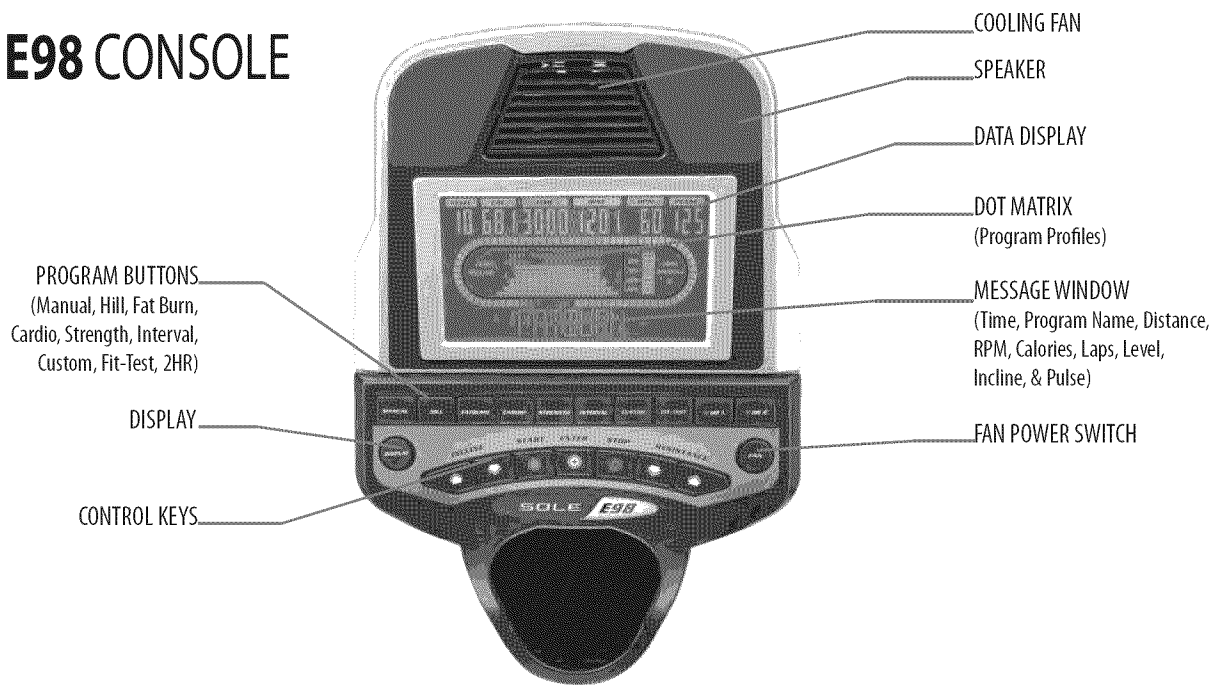

POWER UP

When power is connected to the Elliptical the console will automatically power up. These models are connected directly to 115 VAC and there is a power switch located where the line cord plugs into the unit on the left side near the front (See page 4 for location).

When it is first powered on, the console will perform an internal self-test. During this time all the lights will turn on. When the lights go off, the Message window will show a software version (i.e.: VER 1.0) and the **Calorie** window will display an odometer reading. The odometer reading displays how many virtual miles the elliptical has gone. The **Time** window displays how many hours the elliptical has been used.

The odometer and time will remain displayed for only a few seconds then the console will go to the startup display. The dot matrix display will be scrolling through the different workout profiles and the Message window will be scrolling the start up message. You may now begin to use the console.

!!ATTENTION

Your new elliptical console might come configured in an in-store 'display mode' of operation, where the console will remain powered on unless the main power switch is turned off. If this is the case, follow this procedure to turn it off: To exit the display mode, for normal operation, press and hold the **Stop**, **Enter** and **Display** keys for five seconds; the display will show: **Display Mode - ON**. Use the **Resistance Up** key to change the setting to **OFF** then press **Enter**

CONSOLE OPERATION

QUICK START

This is the quickest way to start a workout. After the console powers up you just press the Start key to begin, this will initiate the Quick Start mode. In Quick Start the Time will count up from zero and the workload and the resistance and incline may be adjusted manually by pressing the Up or Down buttons. The dot matrix display will be showing a track with a blinking dot indicating your progress as it travels around the track.

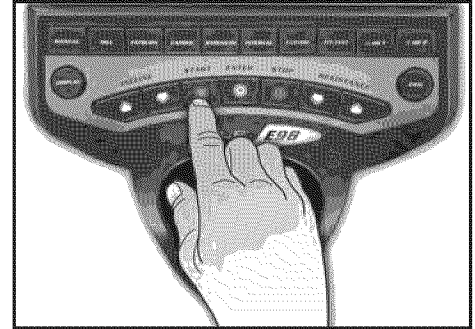

BASIC INFORMATION

The **Message Window** will initially be displaying the Speed in MPH. Each time the **Display Button** - located left of the display - is pressed the next set of information will appear. The information displayed will be: **Speed** in MPH, **Ramp Incline**, **Watts**, **METs** and **Segment Time**. Pressing the **Display Button** one more time will set the display to **Scan** mode where all of the information will be displayed sequentially for 4 seconds each.

When in a program you may change the Dot Matrix profile (Resistance, Incline and Laps) view by pressing the **Enter** button. After scrolling through the two profiles and Laps the Dot Matrix will automatically scroll through the three displays showing each for 4 seconds. The icon associated with each display will light while that view is displayed.

DOT MATRIX CENTER DISPLAY

The Elliptical has a built in heart rate monitoring system. Simply grasping the **Contact Heart Rate Sensors** on the stationary handle bars or wearing the chest strap transmitter (sold separately) will start the heart (see Heart Rate Programs) Icon blinking (this may take a few seconds). The **Pulse Window** will display your heart rate in beats per minute and the HR bar graph will show your current % in relation to projected heart rate maximum. The chest strap is a more accurate and reliable method of heart rate reading. The hand pulse sensors are subject to false readings depending on user physiology and workout habits including how one grips the sensors or how sweaty their hands are.

The **Stop** button actually has several functions. Pressing the **Stop** key once during a program will **Pause** the program for 5 minutes. If you need to get a drink, answer the phone or any of the many things that could interrupt your workout, this is a great feature. To resume your workout during **Pause** just press the **Start** key. If the **Stop** button is pressed twice during a workout the program will end and a **Workout Summary** is displayed. If the **Stop** key is held down for 3 seconds the console will perform a complete Reset. During data entry for a program the **Stop** key performs a Previous Screen function. This allows you to go back one step in the programming each time you press the **Stop** key.

PROGRAMMING THE CONSOLE

Each of the programs can be customized with your personal information and changed to suit your needs. Some of the information asked for is necessary to ensure the readouts are correct. You will be asked for your **Age** and **Weight**. Entering your **Age** is necessary during the Heart Rate control program to ensure the correct settings are entered in the program; entering your exact **Weight** results in a more accurate **Calorie** calculation. Although we cannot provide an exact calorie count we do want to be as close as possible.

A message about Calories: Calorie readings on every piece of exercise equipment, whether it is in a gym or at home, are not accurate and tend to vary widely. They are meant only as a guide to monitor your progress from workout to workout. The only way to measure your calorie burn accurately as in a clinical setting connected to a host of machines. This is because every person is different and burns calories at a different rate.

ENTERING A PROGRAM AND CHANGING SETTINGS

Press each program button to scroll through the program selections. The profile for each program will be displayed in the dot matrix window. The E98 will show the incline profile also when the Display key is pressed. Press the **Enter** key to select a program and begin customizing the settings. If you want to workout without entering new settings, then just press the Start key. This will bypass the programming of data and take you directly to the start of your workout. If you want to change the personal settings, then just follow the instructions in the message window. If you start a program without changing the settings, the default settings will be used.

Note: Age and Weight default settings will change when you enter a new number. So the last Age and Weight entered will be saved as the new default settings. If you enter Age and Weight the first time you use the Elliptical you will not have to enter it every time you work out unless either Age or Weight has changed or someone else enters a different Age and Weight.

PROGRAMMABLE FEATURES

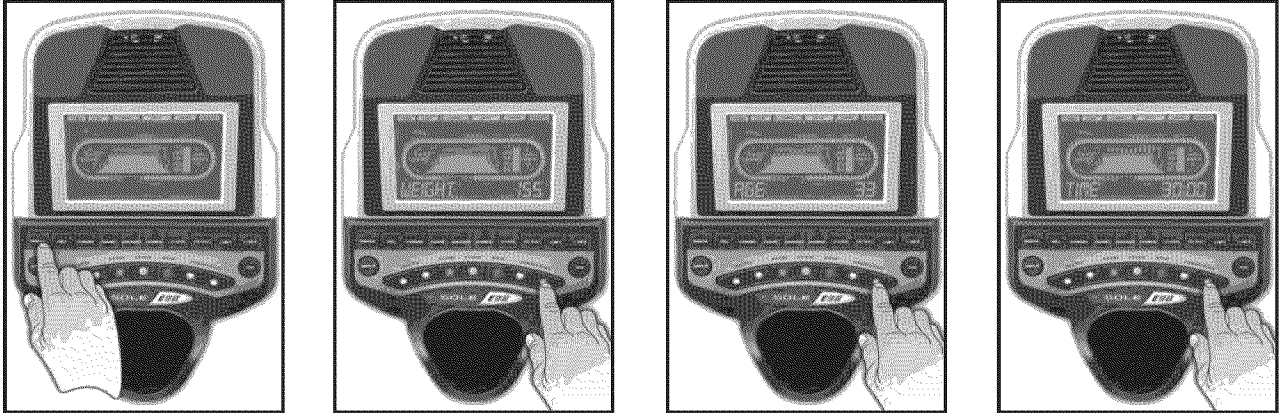

MANUAL PROGRAM

The Manual program works as the name implies, manually. This means that you control the workload yourself and not the computer.

1. Press the **Manual** program button then press the **Enter** key.
2. The Message window will ask you to enter your **Age**. You may adjust the age setting using the **Incline or Resistance** Up and Down keys, then press the **Enter** key to accept the new number and proceed on to the next screen.
3. You are now asked to enter your **Weight**. You may adjust your weight setting using the **Incline or Resistance** Up and Down keys, then press **Enter** to continue.
4. Next is the **Time**. You may adjust the length of **Time** by pressing the Up or Down **Incline or Resistance** keys, then press **Enter** to continue..
5. Now you are finished editing the settings and can begin your workout by pressing the Start key. You can also go back and modify your settings by pressing the Stop key to go back one level of the programming screen.
6. Once the program starts the elliptical will be set to level one. This is the easiest level and it is a good idea to stay at level one for a while to warm up. If you want to increase the workload at any time press the **Resistance** Up key; the **Resistance** Down key will decrease the workload.
7. During the Manual program you will be able to scroll through the data in the message window by pressing the **Display** key.
8. When the program ends the message window will show a summary of your workout. The summary will be displayed for a short time then the console will return to the start-up display.

PRESET PROGRAMS

The Elliptical has five different programs that have been designed for a variety of workouts. These five programs have factory preset work level profiles for achieving different goals.

Hill

The **Hill** program simulates going up and down a hill. The resistance in the pedals will steadily increase and then decrease during the program.

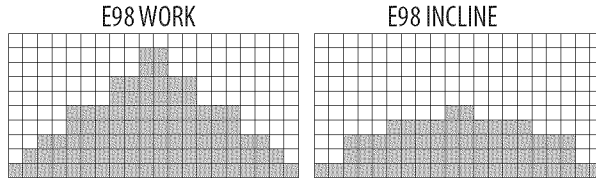

Fat Burn

The **Fat Burn** program is designed, as the name implies, to maximize the burning of fat. There are many schools of thought on the best way to burn fat but most experts agree that a lower exertion level that stays at a steady workload is the best. The absolute best way to burn fat is to keep your heart rate at around 60% to 70% of its maximum potential. This program does not use heart rate but simulates a lower, steady exertion workout.

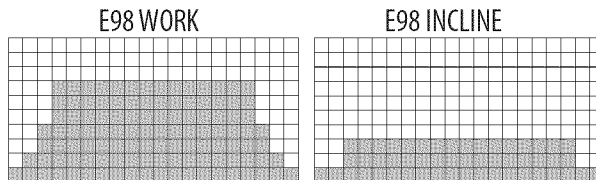

Cardio

The **Cardio** program is designed to increase your cardiovascular function and endurance. This is exercise for your heart and lungs. It will build up your heart muscle and increase blood flow and lung capacity. This is achieved by incorporating a higher level of exertion with slight fluctuations in work.

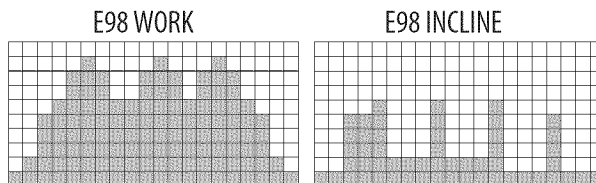

Strength

The **Strength** program is designed to increase muscular strength in your lower body. This program will steadily increase in resistance to a high level and forces you to sustain it. This is designed to strengthen and tone your legs and glutes (muscles of the butt).

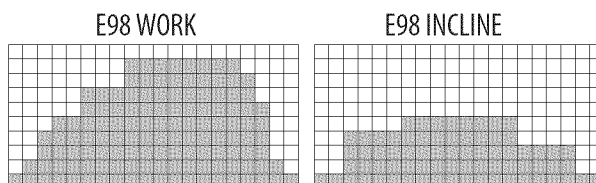

Interval

The **Interval** program takes you through high levels of intensity followed by periods of low intensity. This program increases your endurance by depleting your oxygen level followed by periods of recovery to replenish oxygen. Your cardiovascular system gets programmed to use oxygen more efficiently this way. This program also forces your body to become more efficient due to spikes in heart rate, between recovery periods. This aids in heart rate recovery from intense activities.

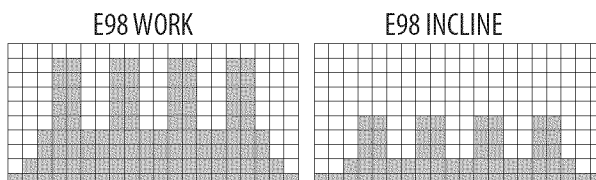

PROGRAMMING PRESET BUTTONS

1. Press the desired program button then press the **Enter** key.
2. The message window will ask you to enter your **Age**. You may adjust the age setting, using the **Incline** or **Resistance** Up and Down keys, then press the **Enter** key to accept the new number and proceed on to the next screen.
3. You are now asked to enter your **Weight**. You may adjust your weight using the **Incline** or **Resistance** Up and Down keys then press **Enter** to continue.
4. Next is **Time**. You may adjust the **Time** and press **Enter** to continue.
5. Now you are asked to adjust the **Max Level**. This is the peak exertion level you will experience during the program (the highest colored segment/box of the program profile). Adjust the level and then press **Enter**.
6. Now you are asked if you want to turn off the incline profile. Use the **Incline** Up or Down keys to turn the **Incline** on or off then press **Enter**.
7. Now you are finished editing the settings and can begin your workout by pressing the **Start** key. You can also go back and modify your settings by pressing the **Stop** key to go back one screen or **Enter** to go back to the beginning.
8. If you want to increase or decrease the resistance or incline at any time during the program press the **Incline** or **Resistance** Up or Down keys.
9. During the program you will be able to scroll through the data in the message window by pressing the **Display** key.
10. When the program ends the message window will show a summary of your workout. The summary will be displayed for a short time then the console will return to the start-up display.

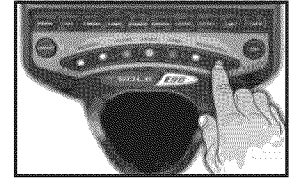

CUSTOM PROGRAM

The customizable User program allows you to build and save your own workout. Follow the instructions below.

1. Select the **Custom** program then press **Enter**. If you have already saved a program, it will be displayed and you are ready to begin. If not or someone else's name is shown, you will have the option of overriding or inputting a username. In the message window, the letter "A" will be blinking. Use the Up and Down **Incline** or **Resistance** buttons to select the appropriate first letter of your name (pressing the Up button will switch to the letter "B"; pressing the Down button will switch to letter "Z"). Press **Enter** when the desired letter is displayed. Repeat this process until all of the characters of your name have been programmed (maximum 7 characters). When finished press **Stop**.
2. If there is a program already stored in **Custom** when you press the key, you will have an option to run the program as it is or delete the program and build a new one. At the welcome message screen, when pressing **Start** or **Enter** you will be prompted: Run Program? Use the Up/Down arrows to select Yes or No. If you select No, you will then be asked if you want to delete the currently saved program. It is necessary to delete the current program if you want to build a new one.
3. The message window will ask you to enter your **Age**. You may enter your weight using the **Incline** or **Resistance** Up and Down keys, then press the **Enter** key to accept the new number and proceed on to the next screen.
4. You are now asked to enter your **Weight**. You may adjust the age number using the **Incline** or **Resistance** Up and Down keys, then press **Enter** to continue.
5. Next is **Time**. You may adjust the **Time** using the **Incline** or **Resistance** Up and Down keys and press **Enter** to continue.
6. Now the first column will be blinking and you are asked to adjust the level for the first segment of the workout. When you finish adjusting the first segment, or if you don't want to change, then press **Enter** to continue to the next segment. The next segment will show the same level as the previously adjusted segment. Repeat the same process as the last segment then press **Enter**. Continue this process until all twenty segments have been set.
7. Now the first column will be blinking again and you are asked to adjust the Incline level for the first segment of the workout. Follow the same procedure for building the Incline profile as you did for the resistance profile.
8. The message window will then tell you to start to begin (and save the program) or **Enter** to modify the program. Pressing **Stop** will exit to the start up screen.
9. If you want to increase or decrease the workload at any time during the program press the **Incline** or **Resistance** Up or Down key. This will only affect the **Incline** or **Resistance** for the present column in the profile. When the profile changes to the next column it will return to the preset work level.
10. During the **Custom** program you will be able to scroll through the data in the message window by pressing the **Display** key.
11. When the program ends the message window will show a summary of your workout. The summary will be displayed for a short time then the console will return to the start-up display.

FITNESS TEST PROGRAM

The fitness test will assess your fitness level and give a score at the end of the test. This score is not a Vo2 max number, but just a number to use as a reference. You can take the test every month and the score should be higher as your level of fitness improves. The test will take anywhere from 6–15 minutes. The test will ask you to maintain a pedal speed of 50 RPM and will automatically make adjustments to the work load depending on your heart rate response to set work levels. The test ends when you reach your target heart rate which is 85% of your maximum heart rate (Max HR = 220 – your age) or if your HR exceeds 110 BPM for 2 consecutive stages.

Fitness Test Programming

1. Press the **Fit-test** button and press **Enter**.
2. The message window will ask you to enter your **Age**. You may adjust the age setting, using the **Resistance** Up and Down keys then press the **Enter** key to accept the new number and proceed on to the next screen.
3. You are now asked to enter your **Weight**. You may adjust the weight number using the **Resistance** Up and Down keys then press enter to continue.
4. Now press **Start** to begin the test or **Enter** to modify your settings.

Before the test

- Make sure you are in good health; check with your physician before performing any exercise if you are over the age of 35 or persons with pre-existing health conditions.
- Make sure you have warmed up and stretched before taking the test.
- Do not take in caffeine before the test.
- Hold the hand grips gently, do not tense up.

During the test

- The console must be receiving a steady heart rate for the test to begin. You may use the hand pulse sensors or wear a heart rate chest strap transmitter.
- You must maintain a steady 50 RPM pedal speed. If your pedal speed drops below 48 RPM or goes above 52 RPM the console will emit a steady beeping sound until you are within this range.
- You may scroll through the various data readings in the message window by pressing the Display button under the message window.
 1. The message window will always display your pedal speed on the right side to help you maintain 50RPM.
 2. The data shown during the test is:
 - a. Work in KGM is actually an abbreviated form of kg-m/min. which is a work measurement of kilogram-force meter/minute
 - b. Work in Watts (1 watt is equal to 6.11829727787 kg-m/min.)
 - c. HR is your actual heart rate; TGT is the target heart rate to reach to end the test.
 - d. Time is the total elapsed time of the test.

After the test

- Cool down for about one to three minutes.
- Take note of your score because the console will automatically return to the start-up mode after a few minutes.

| | | 1st Stage | Level 1 (10W) 60 kgm/min | |
|------------|--------------------------------|--------------------------------|-------------------------------|-------------------------------|
| Heart Rate | HR<80 | HR: 80-90 | HR: 90-100 | HR>100 |
| 2nd Stage | Level 18 (80W) 480 kgm/min | Level 13 (61W) 366 kgm/min | Level 8 (44W) 264 kgm/min | Level 4 (28W) 168 kgm/min |
| 3rd Stage | Level 23 (107W) 642 kgm/min | Level 18 (80W) 480 kgm/min | Level 13 (61W) 366 kgm/min | Level 8 (44W) 264 kgm/min |
| 4th Stage | Level 25 (124W) 744 kgm/min | Level 23 (107W) 642 kgm/min | Level 17 (76W) 456 kgm/min | Level 13 (61W) 366 kgm/min |

HEART RATE PROGRAMS

Before we get started, a word about Heart Rate:

The old motto, "no pain, no gain", is a myth that has been overpowered by the benefits of exercising comfortably. A great deal of this success has been promoted by the use of heart rate monitors. With the proper use of a heart rate monitor, many people find that their usual choice of exercise intensity was either too high or too low and exercise is much more enjoyable by maintaining their heart rate in the desired benefit range.

To determine the benefit range in which you wish to train, you must first determine your Maximum Heart Rate. This can be accomplished by using the following formula: 220 minus your age. This will give you the Maximum Heart Rate (MHR) for someone of your age. To determine the effective heart rate range for specific goals you simply calculate a percentage your MHR. Your Heart rate training zone is 50% to 90% of your maximum heart rate. 60% of your MHR is the zone that burns fat while 80% is for strengthening the cardio vascular system. This 60% to 80% is the zone to stay in for maximum benefit.

For someone who is 40 years old their target heart rate zone is calculated:

$$\begin{aligned} 220 - 40 &= 180 \text{ (maximum heart rate)} \\ 180 \times .6 &= 108 \text{ beats per minute} \\ &\text{(60\% of maximum)} \\ 180 \times .8 &= 144 \text{ beats per minute} \\ &\text{(80\% of maximum)} \end{aligned}$$

So for a 40 year old the training zone would be 108 to 144 beats per minute.

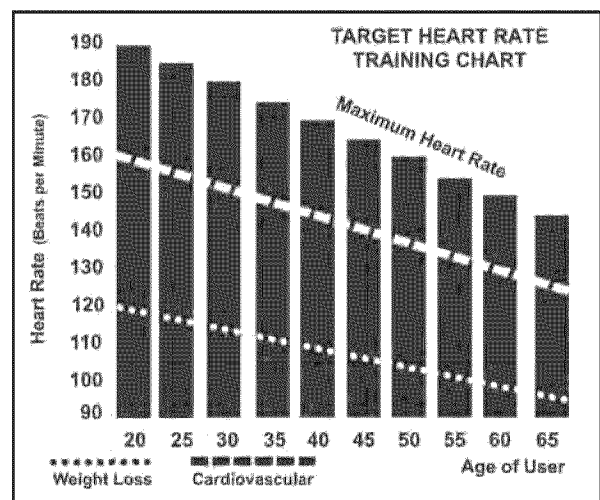

If you enter your age during programming the console will perform this calculation automatically. Entering your age is used for the Heart Rate control programs. After calculating your MHR you can decide upon which goal you would like to pursue.

The two most popular reasons for, or goals, of exercise are cardiovascular fitness (training for the heart and lungs) and weight control. The black columns on the chart above represent the MHR for a person whose age is listed at the bottom of each column. The training heart rate, for either cardiovascular fitness or weight loss, is represented by two different lines that cut diagonally through the chart. A definition of the lines' goal is in the bottom left-hand corner of the chart. If your goal is cardiovascular fitness or if it is weight loss, it can be achieved by training at 80% or 60%, respectively, of your MHR on a schedule approved by your physician. Consult your physician before participating in any exercise program.

With all SOLE Heart Rate Control elliptical machines you may use the heart rate monitor feature without using the Heart Rate Control program. This function can be used during manual mode or during any of the nine different programs. The Heart Rate Control program automatically controls resistance at the pedals.

RATE OF PERCEIVED EXERTION

Heart rate is important but listening to your body also has a lot of advantages. There are more variables involved in how hard you should workout than just heart rate. Your stress level, physical health, emotional health, temperature, humidity, the time of day, the last time you ate and what you ate, all contribute to the intensity at which you should workout. If you listen to your body, it will tell you all of these things.

The rate of perceived exertion (RPE), also know as the Borg scale, was developed by Swedish physiologist G.A.V. Borg. This scale rates exercise intensity from 6 to 20 depending upon how you feel or the perception of your effort.

The scale is as follows:

Rating Perception of Effort

- 6 Minimal
- 7 Very,very light
- 8 Very,very light +
- 9 Very light
- 10 Very light +
- 11 Fairly light
- 12 Comfortable
- 13 Somewhat hard
- 14 Somewhat hard +
- 15 Hard
- 16 Hard +
- 17 Very hard
- 18 Very hard +
- 19 Very,very hard
- 20 Maximal

You can get an approximate heart rate level for each rating by simply adding a zero to each rating. For example a rating of 12 will result in an approximate heart rate of 120 beats per minute. Your RPE will vary depending up the factors discussed earlier. That is the major benefit of this type of training. If your body is strong and rested, you will feel strong and your pace will feel easier. When your body is in this condition, you are able to train harder and the RPE will support this. If you are feeling tired and sluggish, it is because your body needs a break. In this condition, your pace will feel harder. Again, this will show up in your RPE and you will train at the proper level for that day.

USING HEART RATE TRANSMITTER (SOLD SEPARATELY)

How to wear your wireless chest strap transmitter:

1. Attach the transmitter to the elastic strap using the locking parts.
2. Adjust the strap as tightly as possible as long as the strap is not too tight to remain comfortable.
3. Position the transmitter with the logo centered in the middle of your body facing away from your chest (some people must position the transmitter slightly left of center). Attach the final end of the elastic strap by inserting the round end and, using the locking parts, secure the transmitter and strap around your chest.
4. Position the transmitter immediately below the pectoral muscles.
5. Sweat is the best conductor to measure very minute heart beat electrical signals. However, plain water can also be used to pre-wet the electrodes (2 ribbed oval areas on the reverse side of the belt and both sides of the transmitter). It's also recommended that you wear the transmitter strap a few minutes before your work out. Some users, because of body chemistry, have a more difficult time in achieving a strong, steady signal at the beginning. After "warming up", this problem lessens. As noted, wearing clothing over the transmitter/strap doesn't affect performance.
6. Your workout must be within range - distance between transmitter/receiver – to achieve a strong steady signal. The length of range may vary somewhat but generally stay close enough to the console to maintain good, strong, reliable readings. Wearing the transmitter immediately against bare skin assures you of proper operation. If you wish, you may wear the transmitter over a shirt. To do so, moisten the areas of the shirt that the electrodes will rest upon.

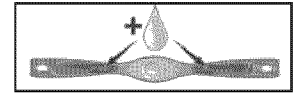
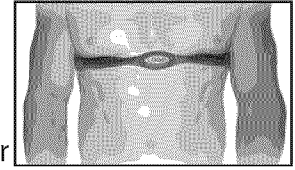

Note: The transmitter is automatically activated when it detects activity from the user's heart. Additionally, it automatically deactivates when it does not receive any activity. Although the transmitter is water resistant, moisture can have the effect of creating false signals, so you should take precautions to completely dry the transmitter after use to prolong battery life (estimated transmitter battery life is 2500 hours). The replacement battery is Panasonic CR2032.

ERRATIC OPERATION

Caution! Do not use this elliptical for Heart Rate Control unless a steady, solid Actual Heart Rate value is being displayed. High, wild, random numbers being displayed indicate a problem.

Areas to look for interference which may cause erratic heart rate:

1. Microwave ovens, TV's, small appliances, etc.
2. Fluorescent lights.
3. Some household security systems.
4. Perimeter fence for a pet.
5. Some people have problems with the transmitter picking up a signal from their skin. If you have problems try wearing the transmitter upside down. Normally the transmitter will be oriented so the logo is right side up.
6. The antenna that picks up your heart rate is very sensitive. If there is an outside noise source, turning the whole machine 90 degrees may de-tune the interference.
7. Another Individual wearing a transmitter within 3' of your machine's console.

If you continue to experience problems contact your dealer.

HEART RATE CONTROL PROGRAM OPERATION

Both programs operate the same, the only difference is that **HR1** is set to 60% and **HR2** is set to 80% of the maximum heart rate. They both are programmed the same way.

To start an **HR** program follow the instructions below or just select the **HR1** or **HR2** program, then the **Enter** button and follow the directions in the message window.

1. Press the **HR1** or **HR2** key then press the **Enter** key.
2. The message window will ask you to enter your **Age**. You may enter your **Age**, using the Up and Down keys, then press the **Enter** key to accept the new number and proceed on to the next screen.
3. You are now asked to enter your **Weight**. You may adjust the **Weight** number using the Up and Down keys, then press **Enter** to continue.
4. Next is **Time**. You may adjust the **Time** and press **Enter** to continue.
5. Now you are asked to adjust your **Target Heart Rate**. This is the heart rate level you will strive to reach and maintain during the program. Adjust the level and then press **Enter**.
NOTE: The heart rate that appears is based on the % you accepted in Step 1. If you change this number it will either increase or decrease the % from Step 1.
6. Now you are finished editing the settings and can begin your workout by pressing the **Start** key. You can also go back and modify your settings by pressing the **Enter** key.
NOTE: At any time during the editing of Data you can press the Stop key to go back one level, or screen.
7. If you want to increase or decrease the workload at any time during the program press the Up or Down key. This will allow you to change your target heart rate at any time during the program.
8. During the **HR1** or **HR2** programs you will be able to scroll through the data in the message window by pressing the adjacent **Display** key.
9. When the program ends you may press **Start** to begin the same program again or Stop to exit the program or you can save the program you just completed as a **Custom Program** by pressing the **Custom** key and following the instructions in the message window.

GENERAL MAINTENANCE

1. Wipe down all areas in the sweat path with a damp cloth after each workout.
2. If a squeak, thump, clicking or rough feeling develops the main cause is most likely one of two reasons:
 - I. The hardware was not sufficiently tightened during assembly. All bolts that were installed during assembly need to be tightened as much as possible. It may be necessary to use a larger wrench than the one provided if you cannot tighten the bolts sufficiently. I cannot stress this point enough; 90% of calls to the service department for noise issues can be traced to loose hardware or the rear rails being dirty.
 - II. Dirt build-up on the rear rails and polyurethane wheels are also a source of noise.Noise from build-up on the rails can cause a thumping sound that you would swear is coming from inside the main body of the machine because noise travels, and is amplified in the tubing of the frame. Clean the rails and wheels with a lint free cloth and rubbing alcohol. Stubborn build-up can be removed with your thumbnail or a non-metallic scraper, like the back edge of a plastic knife. After cleaning, apply a small amount of lubricant on the rails with your fingers or a lint free cloth. You only need a thin coat of lubrication, wipe off any excess.
3. If squeaks or other noises persist, check that the unit is properly leveled before calling the service department.

MAINTENANCE MENU IN CONSOLE SOFTWARE

1. Press and hold the **Start**, **Stop** and **Enter** key at the same time, until the display shows "Maintenance Menu". Press the **Enter** key.
2. You can now scroll through the menu using the **Resistance** Up/Down keys. Use the **Stop** key to return to previous menu selection. The menu selections are:
 - A. **Key Test**
 - B. **Display Test**
 - C. **Functions**
 - I. **Display Mode** - Turn on to have the console power down automatically after 30 minutes of inactivity
 - II. **Pause Mode** - Turned on to allow 5 minutes of pause, turn off to have console pause in definitely
 - III. **ODO Reset** - Resets the Odometer reading to zero
 - IV. **Units** - Choose from English(Imperial) or Metric display readings
 - V. **PWM Test** - For testing the Brake function
 - D. **Factory Settings**
 - E. **Exit**

Incline Calibration: If there is a problem with the incline, try running the calibration. Press the **Incline** Up key and the **Start** key at the same time. Hold them down for 5 seconds and the Incline calibration will start and run automatically. If the problem persists contact Sole service department.

MANUFACTURER'S LIMITED WARRANTY

ELLIPTICAL WARRANTY

Effective January 1, 2011

SOLE warrants all its ellipticals' parts for a period of time listed below from the date of retail sale, as determined by sale receipt, or in the absence of a sales receipt eighteen (18) months from the original factory shipping date. SOLE's responsibilities include providing new or remanufactured parts, at SOLE's option, and technical support to our independent dealers and servicing organizations. In the absence of a dealer or service organization, these warranties will be administered by SOLE directly to a consumer. The warranty period applies to the following components:

COMMERCIAL (5 Hours or less use per day)

| | |
|-------|----------|
| Frame | Lifetime |
| Brake | 5 Years |
| Parts | 3 Years |
| Labor | 1 Year |

RESIDENTIAL

| | |
|---------------|----------|
| Frame & Brake | Lifetime |
| Parts | 5 Years |
| Labor | 2 Years |

NORMAL RESPONSIBILITIES OF THE CONSUMER

This warranty applies only to products in ordinary household use or in a non-dues paying, light commercial facility with 5 hours elliptical use or less per day. The consumer or light commercial facility is responsible for the items listed below:

1. The warranty registration card must be completed and returned to the address listed on the card within 10 days of the original purchase to validate the manufacturer's limited warranty.
2. Proper use of the elliptical in accordance with the instructions provided in this manual
3. Proper installation in accordance with instructions provided with the elliptical and with all local electric codes.
4. Proper connection to a grounded power supply of sufficient voltage, replacement of blown fuses, repair of loose connections or defects in house wiring.
5. Expenses for making the elliptical accessible for servicing, including any item that was not part of the elliptical at the time it was shipped from the factory.
6. Damages to the elliptical finish during shipping, installation or following installation.
7. Routine maintenance of this unit as specified in this manual.

EXCLUSIONS

This warranty does not cover the following:

1. CONSEQUENTIAL, COLLATERAL, OR INCIDENTAL DAMAGES SUCH AS PROPERTY DAMAGE AND INCIDENTAL EXPENSES RESULTING FROM ANY BREACH OF THIS WRITTEN OR ANY IMPLIED WARRANTY.
Note: Some states do not allow the exclusion or limitation of incidental or consequential damages, so this limitation or exclusion may not apply to you.
2. Service call reimbursement to the consumer. Service call reimbursement to the dealer that does not involve malfunction or defects in workmanship or material, for units that are beyond the warranty period, for units that are beyond the service call reimbursement period, for elliptical not requiring component replacement, or elliptical not in ordinary household use.
3. Damages caused by services performed by persons other than authorized SOLE service companies; use of parts other than original SOLE parts; or external causes such as corrosion, discoloration of paint or plastic, alterations, modifications, abuse, misuse, accident, improper maintenance, inadequate power supply, or acts of God.
4. Products with original serial numbers that have been removed or altered.
5. Products that have been: sold, transferred, bartered, or given to a third party.
6. Products that do not have a warranty registration card on file at SOLE. SOLE reserves the right to request proof of purchase if no warranty record exists for the product.
7. THIS WARRANTY IS EXPRESSLY IN LIEU OF ALL OTHER WARRANTIES EXPRESSED OR IMPLIED, INCLUDING THE WARRANTIES OF MERCHANTABILITY AND/OR FITNESS FOR A PARTICULAR PURPOSE.
8. Product use in any environment other than a residential setting.
9. Warranties outside of North America may vary. Please contact your local dealer for details.

SERVICE

Keep your bill of sale. Twelve (12) months from the date on the bill of sale or eighteen (18) months from the date of factory shipping as determined by the serial number establishes the labor warranty period should service be required. If service is performed, it is in your best interest to obtain and keep all receipts. This written warranty gives you specific legal rights. You may also have other rights that vary from state to state. Service under this warranty must be obtained by following these steps, in order:

1. Contact your selling authorized SOLE dealer. OR
2. Submit all service requests including serial number, contact information and a brief description of the problem online at www.soletreadmills.com/technical.php?p=service.
3. If you have any questions about your new product or questions about the warranty contact SOLE Fitness at 1-866-780-SOLE (7653). If you have a technical problem with your new elliptical contact SOLE technical service at 866-MYSOLE1 (697-6531).
4. If no local service is available, SOLE will repair or replace the parts, at SOLE's option, within the warranty period at no charge for parts. All transportation costs, both to our factory and upon return to the owner, are the responsibility of the owner. The owner is responsible for adequate packaging upon return to SOLE. SOLE is not responsible for damages that occur during shipping. Make all freight damage claims with the appropriate freight carrier. DO NOT SHIP ANY UNIT TO OUR FACTORY WITHOUT A RETURN AUTHORIZATION NUMBER. All units arriving without a return authorization number will be refused.
5. For any further information, or to contact our service department by mail, send your correspondence to:

SOLE Fitness
P.O. Box 2037
Jonesboro, AR 72402-2037

Product features or specifications as described or illustrated are subject to change without notice. All warranties are made by SOLE.

SOLE

FITNESS

E98 ELLIPTICAL OWNER'S MANUAL



PLEASE CAREFULLY READ THIS ENTIRE MANUAL BEFORE OPERATING YOUR NEW ELLIPTICAL

TABLE OF CONTENTS

| | |
|----------------------------------|----|
| Product Registration | 1 |
| Important Safety Instructions | 2 |
| Important Electrical Information | 3 |
| Important Operation Instructions | 4 |
| Transport Instructions | 4 |
| E98 Assembly Instructions | 7 |
| Elliptical Features | 12 |
| Operation of Your New Elliptical | 13 |
| Programmable Features | 16 |
| Using Heart Rate Monitor | 22 |
| General Maintenance | 24 |
| Manufacturer's Limited Warranty | 25 |

ATTENTION

THIS ELLIPTICAL IS INTENDED FOR **RESIDENTIAL USE ONLY** AND IS WARRANTED FOR THE APPLICATION. ANY OTHER APPLICATION **VOIDS** THIS WARRANTY IN ITS ENTIRETY.

SOLE

FITNESS

CONGRATULATIONS ON YOUR NEW ELLIPTICAL AND WELCOME TO THE SOLE FAMILY!

Thank you for your purchase of this quality elliptical trainer from **SOLE**. Your new elliptical has been manufactured by one of the leading fitness manufacturers in the world and is backed by one of the most comprehensive warranties available. **SOLE** will do all we can to make your ownership experience as pleasant as possible for many years to come.

If you have any questions about your new product or questions about the warranty contact **SOLE** Fitness at **1-866-780-SOLE (7653)**. If you have a technical problem with your new elliptical contact **SOLE** technical service at **866-MYSOLE1 (697-6531)**.

Please take a moment at this time to record below the name of the dealer, their telephone number, and the date of purchase for easy contact in the future. We appreciate your confidence in **SOLE** and we will always remember that you are the reason that we are in business. Please complete and mail your registration card today and enjoy your new elliptical.

Yours in Health,
SOLE Fitness

Name of Dealer _____

Telephone Number of Dealer _____

Purchase Date _____

PRODUCT REGISTRATION

RECORD YOUR SERIAL NUMBER

Please record the Serial Number of this fitness product in the space provided below.

Serial Number _____

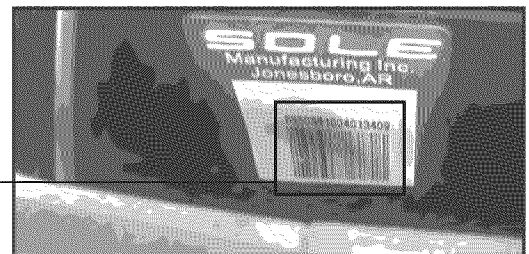

REGISTER YOUR PURCHASE

The self-addressed product registration card must be completed in full and returned to **SOLE**. You can also go to **www.soleellipticals.com** under the support tab to register online.

E98_20101230

IMPORTANT SAFETY INSTRUCTIONS

WARNING - Read all instructions before using this appliance.

DANGER - To reduce the risk of electric shock disconnect your SOLE elliptical from the electrical outlet prior to cleaning and/or service work.

WARNING - To reduce the risk of burns, fire, electric shock, or injury to persons, install the elliptical on a flat level surface with access to a 110-volt, 15-amp grounded outlet with only the elliptical plugged into the circuit.

DO NOT USE AN EXTENSION CORD UNLESS IT IS A 14AWG OR BETTER, WITH ONLY ONE OUTLET ON THE END: DO NOT ATTEMPT TO DISABLE THE GROUNDED PLUG BY USING IMPROPER ADAPTERS, OR IN ANY WAY MODIFY THE CORD SET.

A serious shock or fire hazard may result along with computer malfunctions. See Grounding Instructions, page 3.

- Do not operate elliptical on deeply padded, plush or shag carpet. Damage to both carpet and elliptical may result.
- Keep children away from the elliptical. There are obvious pinch points and other caution areas that can cause harm.
- Keep hands away from all moving parts.
- Never operate the elliptical if it has a damaged cord or plug. If the elliptical is not working properly, call your dealer.
- Keep the cord away from heated surfaces.
- Do not operate where aerosol spray products are being used or where oxygen is being administered. Sparks from the motor may ignite a highly gaseous environment.
- Never drop or insert any object into any openings.
- Do not use outdoors.
- To disconnect, turn all controls to the off position, then remove the plug from the outlet.
- Do not attempt to use your elliptical for any purpose other than for the purpose it is intended.
- The hand pulse sensors are not medical devices. Various factors, including the user's movement, may affect the accuracy of heart rate readings. The pulse sensors are intended only as exercise aids in determining heart rate trends in general.
- Wear proper shoes. High heels, dress shoes, sandals or bare feet are not suitable for use on your elliptical. Quality athletic shoes are recommended to avoid leg fatigue.

SAVE THESE INSTRUCTIONS - THINK SAFETY!

IMPORTANT ELECTRICAL INSTRUCTIONS

WARNING!

NEVER remove any cover without first disconnecting AC power.

If voltage varies by ten percent (10%) or more, the performance of your elliptical may be affected. **Such conditions are not covered under your warranty.** If you suspect the voltage is low, contact your local power company or a licensed electrician for proper testing.

NEVER expose this elliptical to rain or moisture. This product is **NOT** designed for use outdoors, near a pool or spa, or in any other high humidity environment. The operating temperature specification is 40 to 120 degrees Fahrenheit, and humidity is 95% non-condensing (no water drops forming on surfaces).

GROUNDING INSTRUCTIONS

This product must be grounded. If the elliptical should malfunction or breakdown, grounding provides a path of least resistance for electric current, reducing the risk of electric shock. This product is equipped with a cord having an equipment-grounding plug. The plug must be plugged into an appropriate outlet that is properly installed and grounded in accordance with all local codes and ordinances.

DANGER - Improper connection of the equipment-grounding conductor can result in a risk of electric shock. Check with a qualified electrician or serviceman if you are in doubt as to whether the product is properly grounded. Do not modify the plug provided with the product if it will not fit the outlet; have a proper outlet installed by a qualified electrician.

This product is for use on a nominal 110-volt circuit, and has a grounding plug that looks like the plug illustrated below. A temporary adapter that looks like the adapter illustrated below may be used to connect this plug to a 2-pole receptacle as shown below if a properly grounded outlet is not available. The temporary adapter should be used only until a properly grounded outlet, (shown below) can be installed by a qualified electrician. The green colored rigid ear-lug, or the like, extending from the adapter, must be connected to a permanent ground such as a properly grounded outlet box cover. Whenever the adapter is used, it must be held in place by a metal screw.

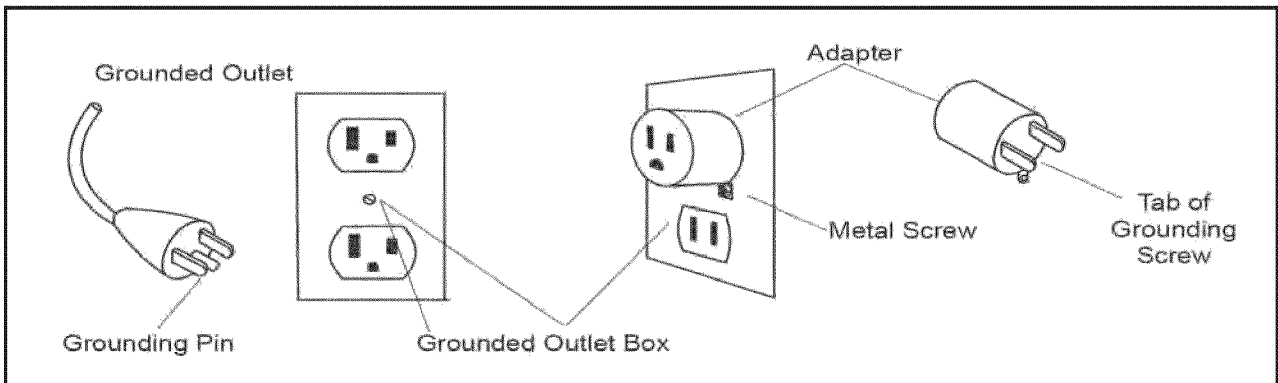

IMPORTANT OPERATION INSTRUCTIONS

- **NEVER** operate this elliptical without reading and completely understanding the results of any operational change you request from the computer.
- Understand that changes in resistance and incline do not occur immediately. Set your desired resistance on the computer console and release the adjustment key. The computer will obey the command gradually.
- **NEVER** use your elliptical during an electrical storm. Surges may occur in your facility or household power supply that could damage elliptical components. Unplug the elliptical during an electrical storm as a precaution.
- Use caution while participating in other activities while pedaling on your elliptical; such as watching television, reading, etc. These distractions may result in serious injury.
- Always hold on to a handrail or hand bar while making control changes (incline, resistance, etc.).
- Do not use excessive pressure on console control keys. They are precision set to function properly with little finger pressure. Pushing harder is not going to make the unit go faster or slower. If you feel the buttons are not functioning properly with normal pressure contact your **SOLE** dealer.

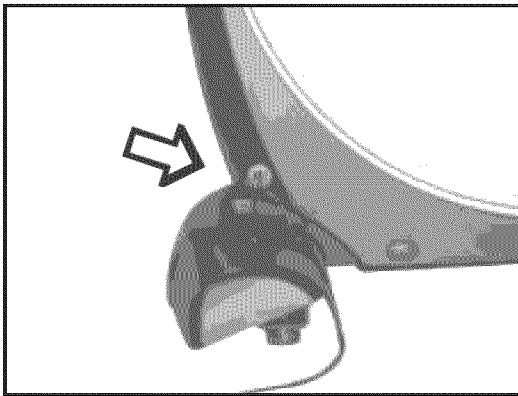

POWER CONNECTOR - FRONT, LEFT SIDE OF UNIT

TRANSPORT INSTRUCTIONS

The elliptical is equipped with two transport wheels which are engaged when the rear of the elliptical is lifted.

E98 ASSEMBLY PACK CHECKLIST

1

HARDWARE STEP 1

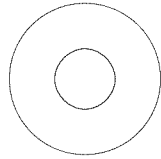

#158. 3/8" x 19 x 1.5T
Flat Washer (2 pcs)

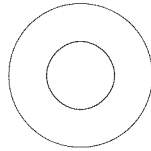

#154. 5/16" x 20 x 1.5T
Flat Washer (4 pcs)

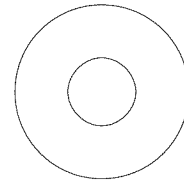

#164. 3/8" x 23 x 2T
Curved Washer (2 pcs)

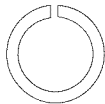

#167. 3/8" x 2T
Split Washer (1 pc)

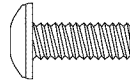

#128. M5 x 10mm
Phillips Head Screw (4 pcs)



#145. 3/8" x 7T
Nylloc Nut (2 pcs)



#166. 5/16" x 1.5T
Split Washer (4 pcs)



#168. 5/16"
Star Washer (4 pcs)

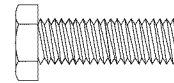

#116. 3/8" x 3/4"
Hex Head Bolt (2 pcs)

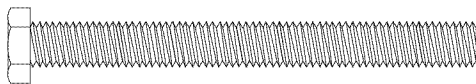

#115. 5/16" x 2-1/4"
Hex Head Bolt (4 pcs)

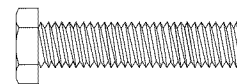

#117. 3/8" x 1-1/2"
Hex Head Bolt (2 pcs)

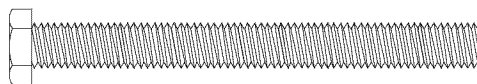

#118. 3/8" x 2-1/4"
Hex Head Bolt (1 pc)

2 HARDWARE STEP 2

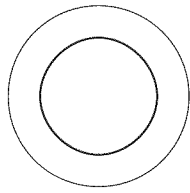

#163. 25mm
Wave Washer (4 pcs)

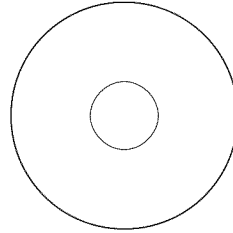

#160. 3/8" x 30 x 2T
Flat Washer (2 pcs)

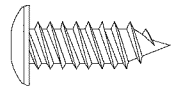

#132. 3.5 x 12mm
Sheet Metal Screw (8 pcs)

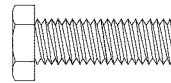

#116. 3/8" x 3/4"
Hex Head Bolt (2 pcs)

3 HARDWARE STEP 3

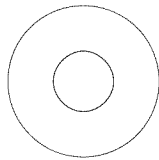

#154. 5/16" x 20 x 1.5T
Flat Washer (2 pcs)



#143. 5/16" x 7T
Nyloc Nut (2 pcs)

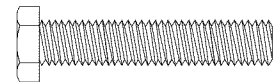

#114. 5/16" x 1-1/4"
Hex Head Bolt (2 pcs)

4 HARDWARE STEP 4

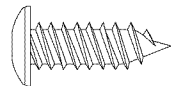

#132. 3.5 x 12mm
Sheet Metal Screw (10 pcs)

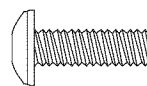

#129. M5 x 15mm
Phillips Head Screw (29 pcs)

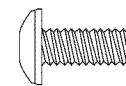

#131. M6 x 10mm
Phillips Head Screw (4 pcs)

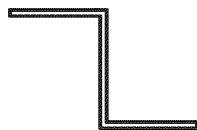

#20. Bracket (2 pcs)

ASSEMBLY TOOLS

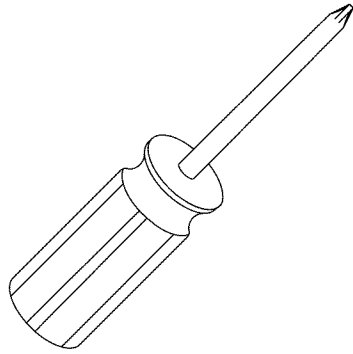

#171. Phillips Head Screwdriver

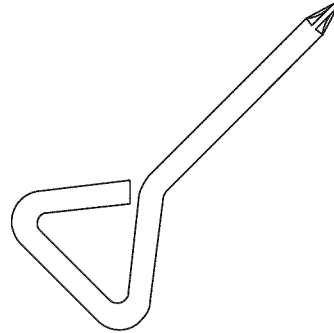

#170. Short Phillips Head Screwdriver

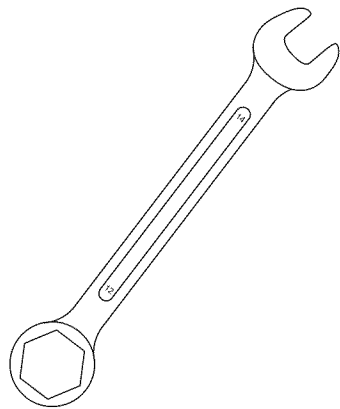

#187. 12/14mm Wrench

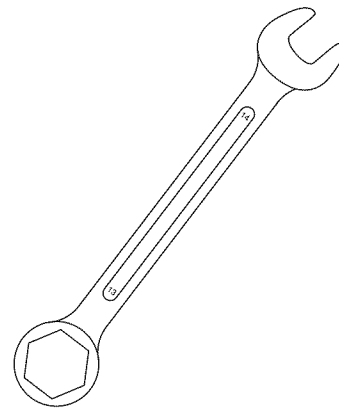

#169. 13/14mm Wrench

E98 ASSEMBLY INSTRUCTIONS

PRE-ASSEMBLY

1. Using a razor knife (Box Cutter) cut the outside, bottom, edge of box along the dotted Line. Lift Box over the unit and unpack.
2. Carefully remove all parts from carton and inspect for any damage or missing parts. If damaged parts are found, or parts are missing, contact your dealer immediately.
3. Locate the hardware package. Remove the tools first. Remove the hardware for each step as needed to avoid confusion. The numbers in the instructions that are in parenthesis (#) are the item number from the assembly drawing for reference.

1 INCLINE RAIL & CONSOLE MAST

1. Install the Incline Rail Assembly (2) into the U-channel bracket of the Main Frame (1). Secure with the six bolts & associated hardware as follows: From the sides install two Hex Head Bolts (117) with two Flat Washers (158) and two Nylon Nuts (145). From the top install four Hex Head Bolts (115), four Split Washers (166), four Flat Washers (154), and four Star Washers (168), and tighten with the Wrenches provided (169 & 187).
2. Connect the three Incline Motor Power lines by matching the Red, White and Black color codes of the wires (43) and the 3-pin position Sensor Connector (44). Locate the Console Mast (12) and Console Mast Cover (83) and slide the Cover onto the Mast as far as it will go. Make sure the Console Mast Cover is facing the correct way. At the top opening of the Main Frame of the elliptical is a Computer Cable (45); Secure the free end of the twist tie that exits the bottom of the console mast (12) to this cable. Pull the opposite end of this twist tie up through the console mast (12) until the cable exits the top. Install the Console Mast (12) into the receiving bracket on the top of the Main Frame (1). Pull slightly on the computer cable at the top of the mast while installing. This will ensure the cable does not get pinched and shorted during console mast assembly.
3. Put one Split Washer (167) onto the Long Hex Head Bolt (118) and install through the left side of the receiving bracket into the Console Mast (12). Put the two Curved Washers (164) onto the two Short Hex Head Bolts (116) and install through the front of the console mast. Using Wrench (184), tighten the (116) bolts first, then the (118) bolt, and lastly the fourth bolt, which is pre-installed, firmly. These bolts should be tightened as much as you possibly can. This is the main joint of the unit. If not tightened sufficiently, this could lead to noise and instability issues.
4. Plug the Computer Cable (45) and two Hand pulse Cables (52 & 56) into the back of the console. Secure the Console (40) on the console mounting plate with four Phillips Head Screws (128).

HARDWARE STEP 1

- #158. 3/8" x 19 x 1.5T Flat Washer (2 pcs)
- #154. 5/16" x 20 x 1.5T Flat Washer (4 pcs)
- #164. 3/8" x 23 x 2T Curved Washer (2 pcs)
- #167. 3/8" x 2T Split Washer (1 pc)
- #128. M5 x 10mm Phillips Screw (4 pcs)
- #145. 3/8" x 7T Nylon Nut (2 pcs)
- #166. 5/16" x 1.5T Split Washer (4 pcs)
- #168. 5/16" Star Washer (4 pcs)
- #116. 3/8" x 3/4" Hex Head Bolt (2 pcs)
- #115. 5/16" x 2-1/4" Hex Head Bolt (4 pcs)
- #117. 3/8" x 1-1/2" Hex Head Bolt (2 pcs)
- #118. 3/8" x 2-1/4" Hex Head Bolt (1 pc)

2 HANDLEBAR

1. Install two Washers (163) onto the Left and Right sides of the Handle Bar axle.
2. Slide the Left (10) and Right (11) Handle Bars onto the appropriate side of the axle. The handlebars have a small sticker on them indicating L (left) and R (right). *Make sure the handlebars are facing the correct direction – see illustration.*
3. Install two Flat Washers (160) onto the two Hex Head Bolts (116). Insert and and tighten in the threaded holes at the ends of each axle.
4. Install the Handle Bar Covers (91 to 92) and (93 to 94) over the Console Mast axle connections and secure with the eight Sheet Metal Screws (132).

HARDWARE STEP 2

- #163. 25mm Wave Washer (4 pcs)
- #160. 3/8" x 30 x 2T Flat Washer (2 pcs)
- #132. 3.5 x 12mm Sheet Metal Screw (8 pcs)
- #116. 3/8" x 3/4" Hex Head Bolt (2 pcs)

1 ASSEMBLY STEP 1

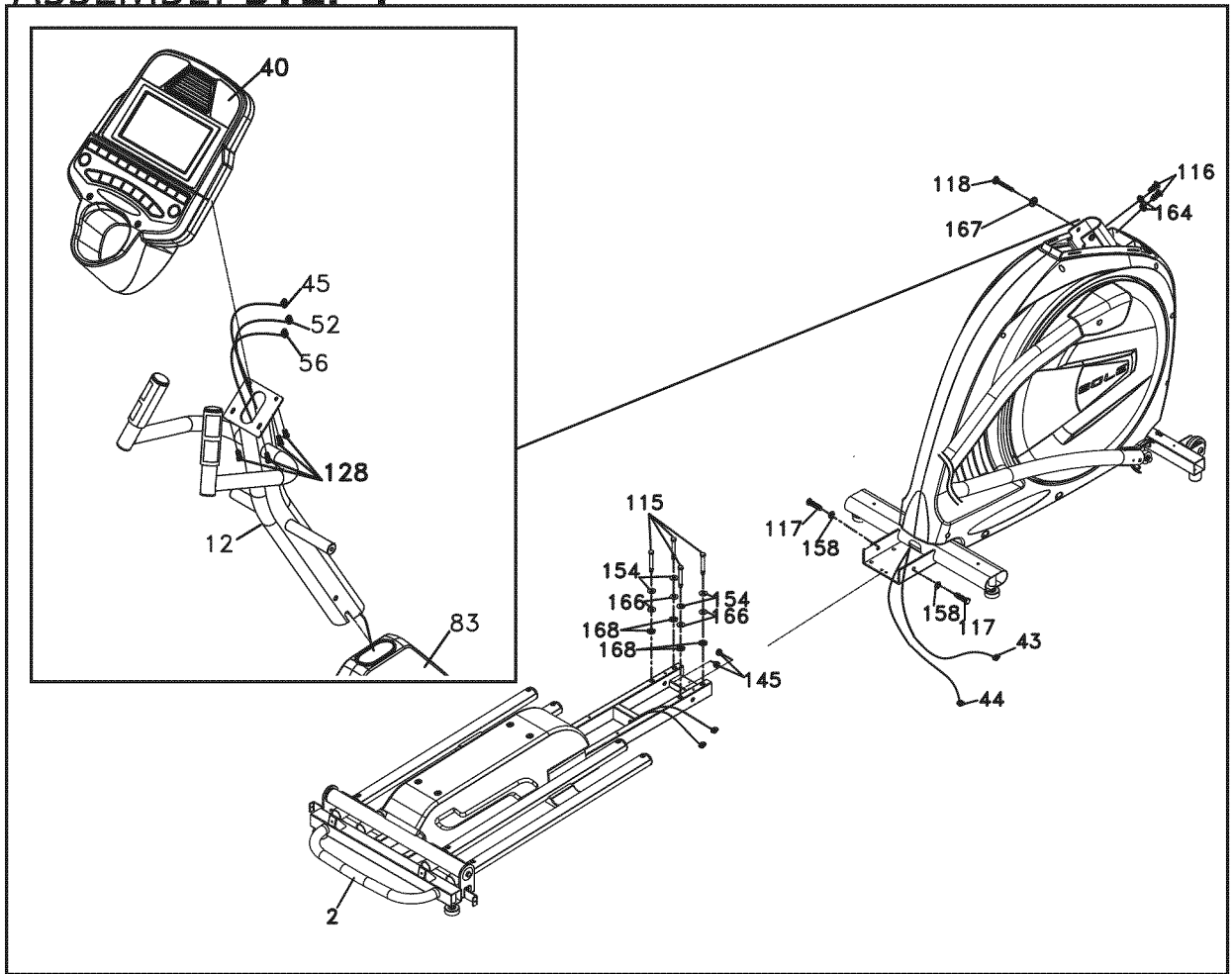

2 ASSEMBLY STEP 2

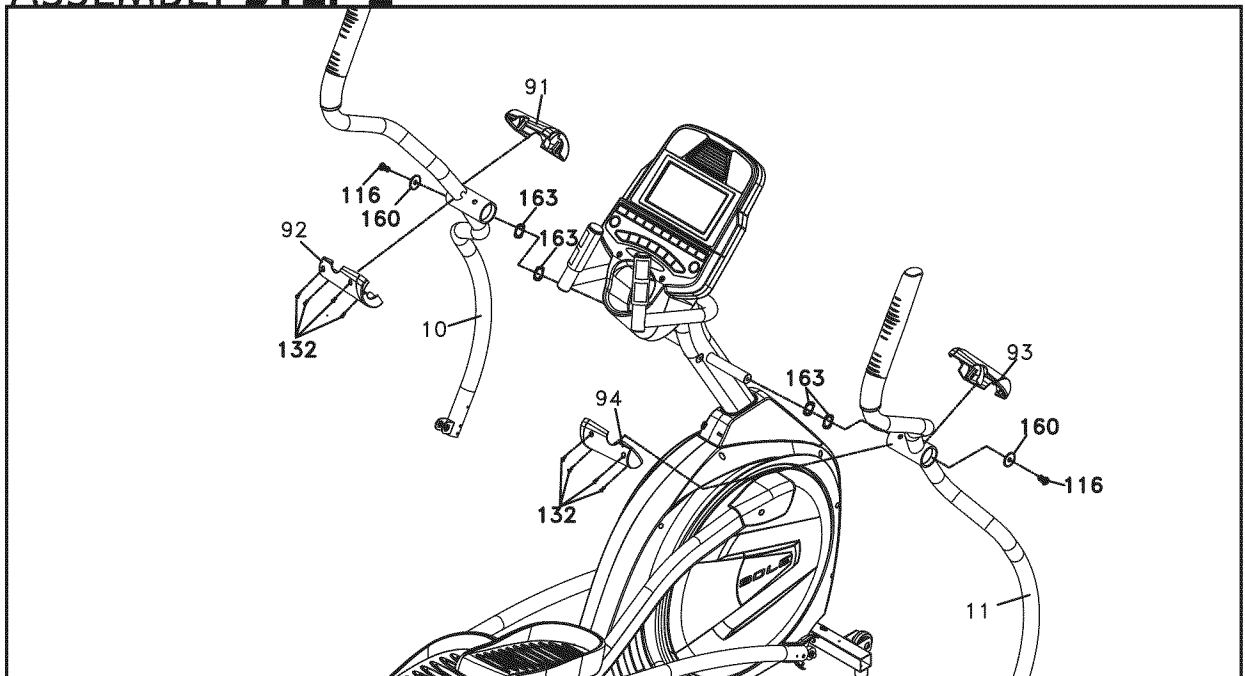

3 CONNECTING ARM

1. Untie the wire holding the Sleeve Spacer (19) in place on the rod-end bushings, located on the ends of the connecting arms (8 & 9). Align the hole in the rod ends with the hole in the brackets of the left and right Handle Bar (10 & 11). The rod end should be on the inside of the Handle Bar bracket. Secure both sides with a Hex Head Bolt (114), Flat Washer (154) and Nyloc Nut (143) by using the wrenches provided (169 & 187).

HARDWARE STEP 3

#154. 5/16" x 20 x 1.5T
Flat Washer (2 pcs)
#143. 5/16" x 7T
Nyloc Nut (2 pcs)
#114. 5/16" x 1-1/4"
Hex Head Bolt (2 pcs)

4 PLASTIC PARTS

1. Match up the console covers (81 & 82) and secure with three Phillips head screws (129) and two Sheet Metal Screws (132) using the short Phillips head screw driver (170). Tighten the Sheet metal screws first.
2. Match up the Connecting Arm Covers (97 & 98-inner covers and 95 & 96 -outer covers). Install the inner covers onto the Left and Right Connecting Arms (8 & 9) and secure each side with two Phillips Head Screws (129) and two Sheet Metal Screws (132) by using the Short Phillips Head Screw Driver (170). Install the outer covers onto the left and right handlebars (10 & 11) and secure each side with two Phillips Head Screws (129) and two Self Tapping Screws (132). Make sure the outer covers are positioned in relation to the arrow on each sticker.
3. Install Sliding Wheel Covers (22) on each side and secure with four Phillips Head Screws (129).
4. Install the two Stabilizer Covers (101 & 102) on the middle stabilizer bar with two Phillips Head Screws (129).
5. Install the Front Stabilizer Cover (90) on the front stabilizer with two Phillips Head Screws (129).
6. Install the two incline Cover brackets (20), with the hole for mounting the plastic cover on the bent tab facing rearward, and secure them on the Incline Rail Assembly (2) with four Phillips Head Screws (131). Install the Rear incline bar cover (100) on the rail base with two Screws (129).
7. Install the Rear Stabilizer Cover (24) on the Rear Stabilizer with four Phillips Head Screws (129).
8. This step to be performed after the elliptical power is plugged in. Run the incline to position 8 and install the incline Rail front cover (99) up against the middle stabilizer tube with four Phillips Head Screws (129).

HARDWARE STEP 4

#132. 3.5 x 12mm Sheet
Metal Screw (10 pcs)
#129. M5 x 15mm
Phillips Head Screw
(29 pcs)
#131. M6 x 10mm
Phillips Head Screw
(4 pcs)
#20. Bracket (2 pcs)

3 ASSEMBLY STEP 3

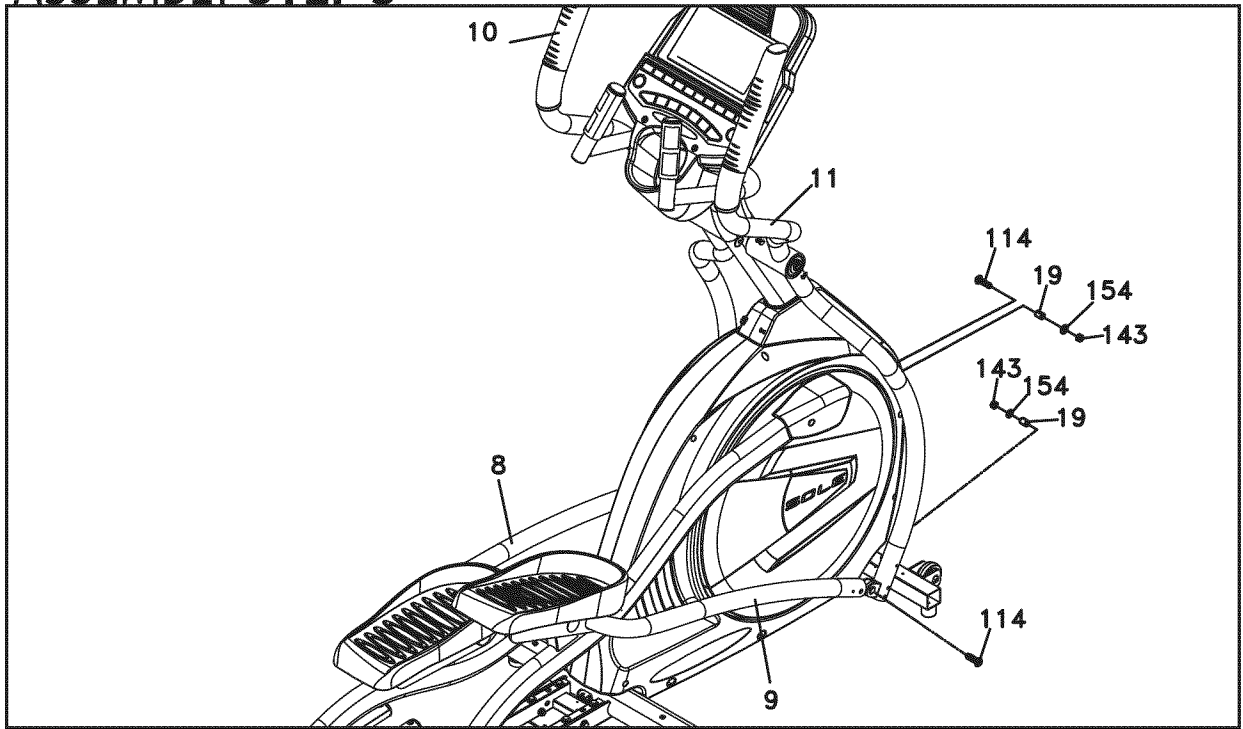

4 ASSEMBLY STEP 4

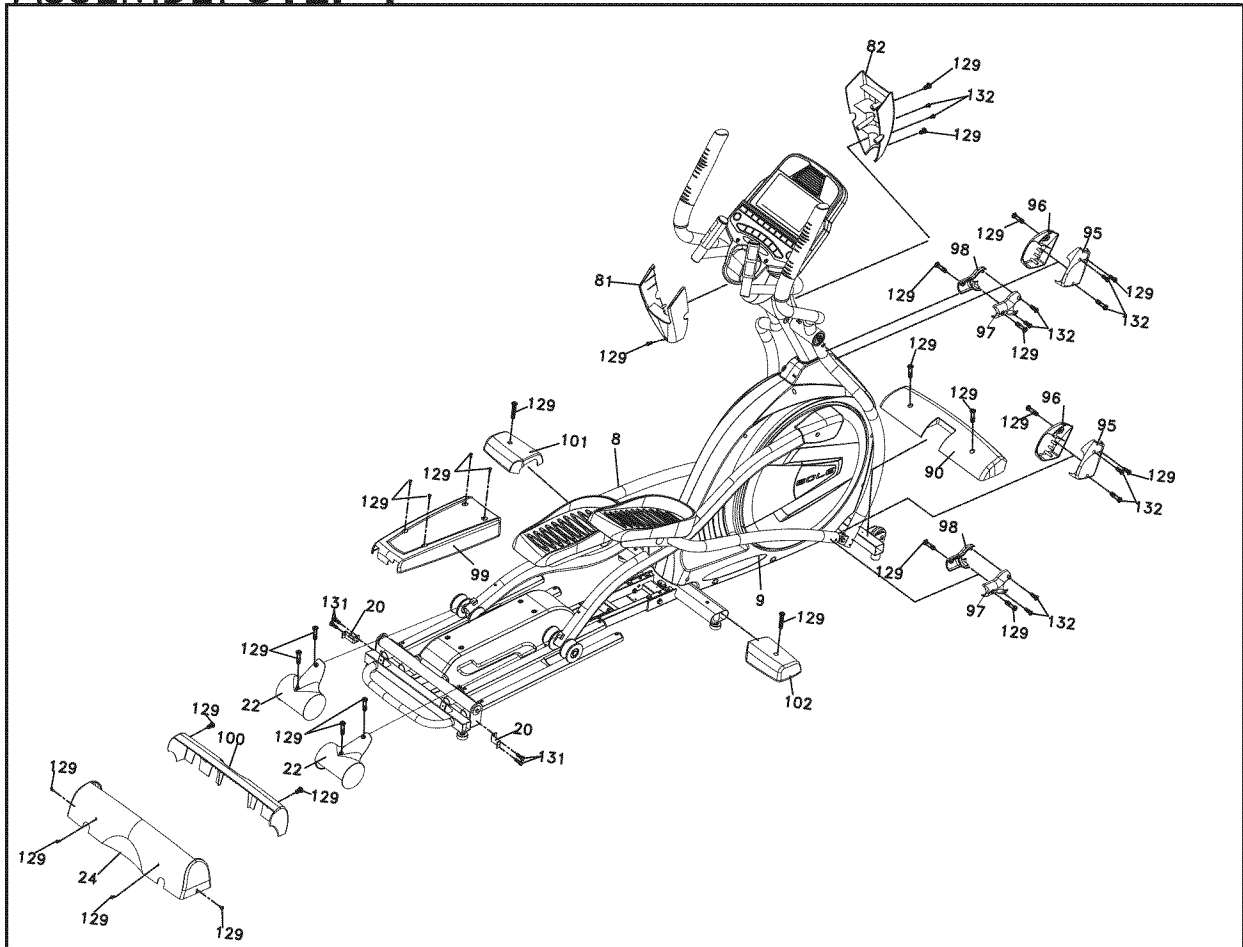

ELLIPTICAL FEATURES

CORRECTLY ALIGNED ORTHOPEDIC FOOT PADS

Through research performed with a leading sports scientist and physical rehabilitation expert; SOLE engineering has developed a breakthrough in pedal design. No other elliptical, at any price, offers this unique feature. The history of elliptical use over the past few years tells us that many users suffer from numb toes while working out on elliptical trainers. Many other users complain of ankle, Achilles tendon, knee and/or hip pain. While researching a solution to these common problems SOLE engineers consulted Richard DeKok, P.T., M.T.C., of St. Bernard's Industrial Rehabilitation Center in Jonesboro Arkansas. Together we identified the inherent problem in elliptical designs and developed a solution to solve the problem. What we found is that when you use an elliptical you tend to push outward during the power stroke and not just straight back. This causes stress on the outer part of the foot and throws off the natural alignment of the joints. Our solution was simple but effective:

- We added a 2-degree inward angle to the footpads. This might sound simple but what it does is puts the users joints back into a neutral alignment. This eases the over stressing of the ankles, knees and hips.

RAMP INCLINE ADJUSTMENT

The E98 has an incline feature that will further increase the variety of your workouts. When the incline is at its lowest position you get a normal elliptical workout. As the incline increases you will feel your knees rise higher with each step; which means you are involving more muscle fibers, due to the increased range of motion.

The E98 has a computer controlled power incline. The power incline is controlled by buttons on the console and will automatically adjust via the incline motor during the built-in workout program.

OPERATION OF YOUR ELLIPTICAL

GETTING FAMILIAR WITH THE CONTROL PANEL

E98 CONSOLE

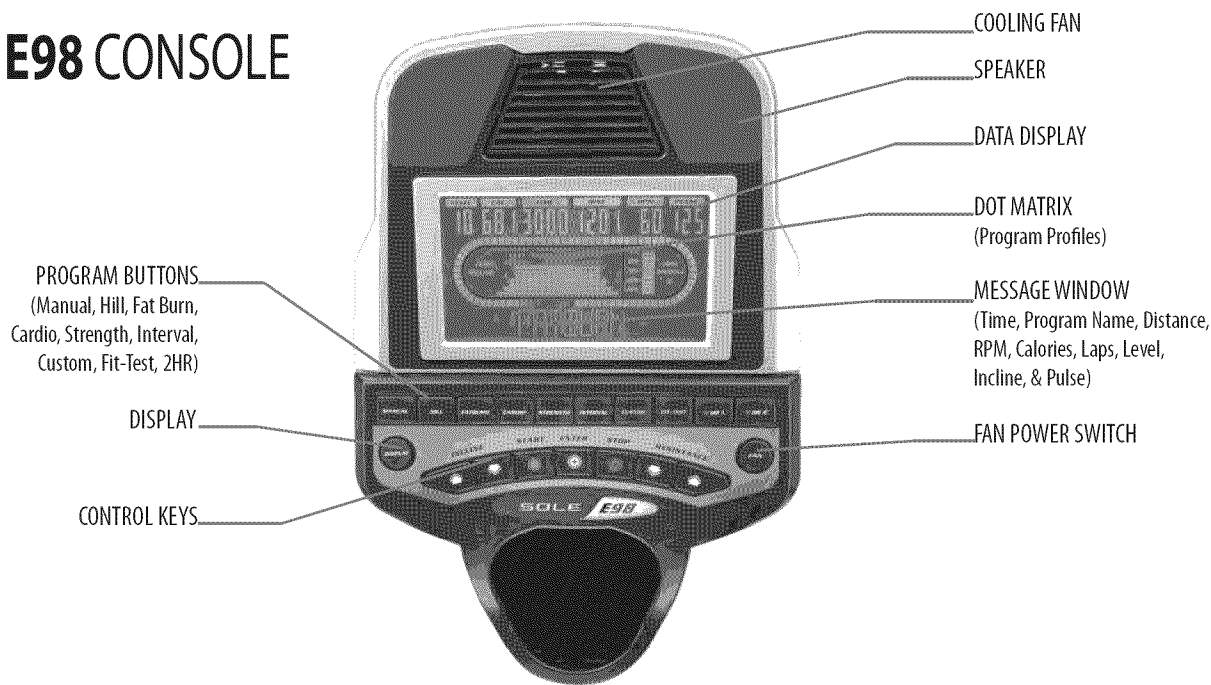

POWER UP

When power is connected to the Elliptical the console will automatically power up. These models are connected directly to 115 VAC and there is a power switch located where the line cord plugs into the unit on the left side near the front (See page 4 for location).

When it is first powered on, the console will perform an internal self-test. During this time all the lights will turn on. When the lights go off, the Message window will show a software version (i.e.: VER 1.0) and the **Calorie** window will display an odometer reading. The odometer reading displays how many virtual miles the elliptical has gone. The **Time** window displays how many hours the elliptical has been used.

The odometer and time will remain displayed for only a few seconds then the console will go to the startup display. The dot matrix display will be scrolling through the different workout profiles and the Message window will be scrolling the start up message. You may now begin to use the console.

!!ATTENTION

Your new elliptical console might come configured in an in-store 'display mode' of operation, where the console will remain powered on unless the main power switch is turned off. If this is the case, follow this procedure to turn it off: To exit the display mode, for normal operation, press and hold the **Stop**, **Enter** and **Display** keys for five seconds; the display will show: **Display Mode - ON**. Use the **Resistance** Up key to change the setting to **OFF** then press **Enter**

CONSOLE OPERATION

QUICK START

This is the quickest way to start a workout. After the console powers up you just press the Start key to begin, this will initiate the Quick Start mode. In Quick Start the Time will count up from zero and the workload and the resistance and incline may be adjusted manually by pressing the Up or Down buttons. The dot matrix display will be showing a track with a blinking dot indicating your progress as it travels around the track.

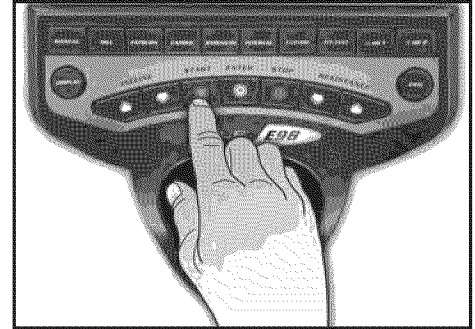

BASIC INFORMATION

The **Message Window** will initially be displaying the Speed in MPH. Each time the **Display Button** - located left of the display - is pressed the next set of information will appear. The information displayed will be: **Speed** in MPH, **Ramp Incline**, **Watts**, **METs** and **Segment Time**. Pressing the **Display Button** one more time will set the display to **Scan** mode where all of the information will be displayed sequentially for 4 seconds each.

When in a program you may change the Dot Matrix profile (Resistance, Incline and Laps) view by pressing the **Enter** button. After scrolling through the two profiles and Laps the Dot Matrix will automatically scroll through the three displays showing each for 4 seconds. The icon associated with each display will light while that view is displayed.

DOT MATRIX CENTER DISPLAY

The Elliptical has a built in heart rate monitoring system. Simply grasping the **Contact Heart Rate Sensors** on the stationary handle bars or wearing the chest strap transmitter (sold separately) will start the heart (see Heart Rate Programs) Icon blinking (this may take a few seconds). The **Pulse Window** will display your heart rate in beats per minute and the HR bar graph will show your current % in relation to projected heart rate maximum. The chest strap is a more accurate and reliable method of heart rate reading. The hand pulse sensors are subject to false readings depending on user physiology and workout habits including how one grips the sensors or how sweaty their hands are.

The **Stop** button actually has several functions. Pressing the **Stop** key once during a program will **Pause** the program for 5 minutes. If you need to get a drink, answer the phone or any of the many things that could interrupt your workout, this is a great feature. To resume your workout during **Pause** just press the **Start** key. If the **Stop** button is pressed twice during a workout the program will end and a **Workout Summary** is displayed. If the **Stop** key is held down for 3 seconds the console will perform a complete Reset. During data entry for a program the **Stop** key performs a Previous Screen function. This allows you to go back one step in the programming each time you press the **Stop** key.

PROGRAMMING THE CONSOLE

Each of the programs can be customized with your personal information and changed to suit your needs. Some of the information asked for is necessary to ensure the readouts are correct. You will be asked for your **Age** and **Weight**. Entering your **Age** is necessary during the Heart Rate control program to ensure the correct settings are entered in the program; entering your exact **Weight** results in a more accurate **Calorie** calculation. Although we cannot provide an exact calorie count we do want to be as close as possible.

A message about Calories: Calorie readings on every piece of exercise equipment, whether it is in a gym or at home, are not accurate and tend to vary widely. They are meant only as a guide to monitor your progress from workout to workout. The only way to measure your calorie burn accurately as in a clinical setting connected to a host of machines. This is because every person is different and burns calories at a different rate.

ENTERING A PROGRAM AND CHANGING SETTINGS

Press each program button to scroll through the program selections. The profile for each program will be displayed in the dot matrix window. The E98 will show the incline profile also when the Display key is pressed. Press the **Enter** key to select a program and begin customizing the settings. If you want to workout without entering new settings, then just press the Start key. This will bypass the programming of data and take you directly to the start of your workout. If you want to change the personal settings, then just follow the instructions in the message window. If you start a program without changing the settings, the default settings will be used.

Note: Age and Weight default settings will change when you enter a new number. So the last Age and Weight entered will be saved as the new default settings. If you enter Age and Weight the first time you use the Elliptical you will not have to enter it every time you work out unless either Age or Weight has changed or someone else enters a different Age and Weight.

PROGRAMMABLE FEATURES

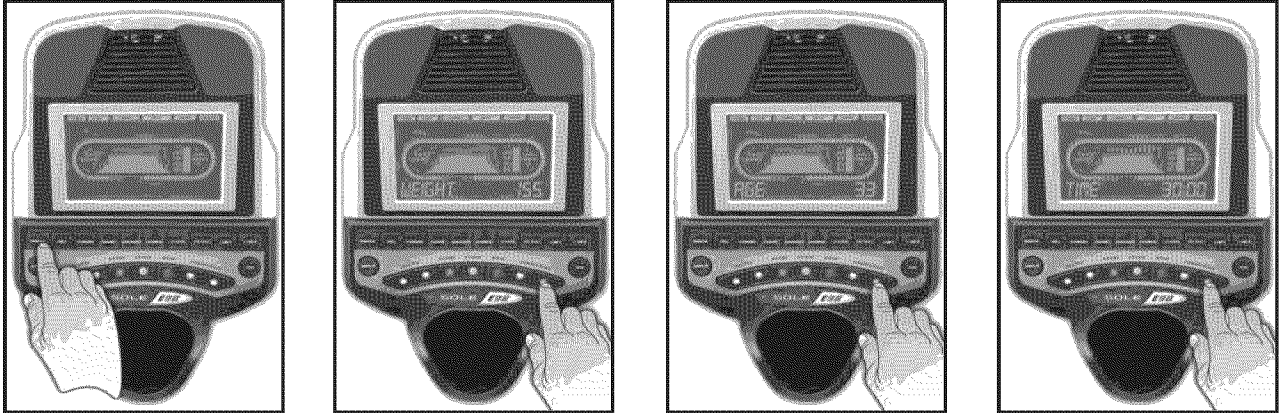

MANUAL PROGRAM

The Manual program works as the name implies, manually. This means that you control the workload yourself and not the computer.

1. Press the **Manual** program button then press the **Enter** key.
2. The Message window will ask you to enter your **Age**. You may adjust the age setting using the **Incline or Resistance** Up and Down keys, then press the **Enter** key to accept the new number and proceed on to the next screen.
3. You are now asked to enter your **Weight**. You may adjust your weight setting using the **Incline or Resistance** Up and Down keys, then press **Enter** to continue.
4. Next is the **Time**. You may adjust the length of **Time** by pressing the Up or Down **Incline** or **Resistance** keys, then press **Enter** to continue..
5. Now you are finished editing the settings and can begin your workout by pressing the Start key. You can also go back and modify your settings by pressing the Stop key to go back one level of the programming screen.
6. Once the program starts the elliptical will be set to level one. This is the easiest level and it is a good idea to stay at level one for a while to warm up. If you want to increase the workload at any time press the **Resistance** Up key; the **Resistance** Down key will decrease the workload.
7. During the Manual program you will be able to scroll through the data in the message window by pressing the **Display** key.
8. When the program ends the message window will show a summary of your workout. The summary will be displayed for a short time then the console will return to the start-up display.

PRESET PROGRAMS

The Elliptical has five different programs that have been designed for a variety of workouts. These five programs have factory preset work level profiles for achieving different goals.

Hill

The **Hill** program simulates going up and down a hill. The resistance in the pedals will steadily increase and then decrease during the program.

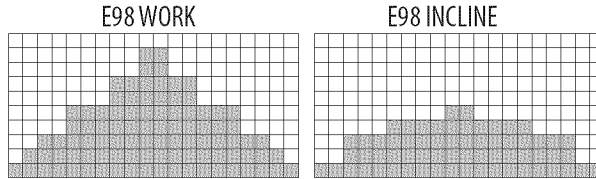

Fat Burn

The **Fat Burn** program is designed, as the name implies, to maximize the burning of fat. There are many schools of thought on the best way to burn fat but most experts agree that a lower exertion level that stays at a steady workload is the best. The absolute best way to burn fat is to keep your heart rate at around 60% to 70% of its maximum potential. This program does not use heart rate but simulates a lower, steady exertion workout.

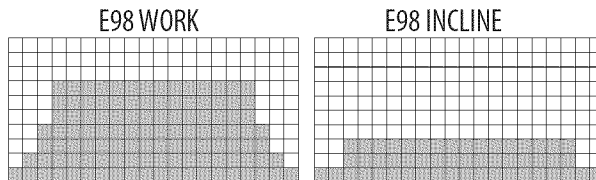

Cardio

The **Cardio** program is designed to increase your cardiovascular function and endurance. This is exercise for your heart and lungs. It will build up your heart muscle and increase blood flow and lung capacity. This is achieved by incorporating a higher level of exertion with slight fluctuations in work.

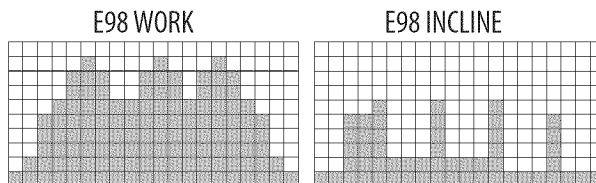

Strength

The **Strength** program is designed to increase muscular strength in your lower body. This program will steadily increase in resistance to a high level and forces you to sustain it. This is designed to strengthen and tone your legs and glutes (muscles of the butt).

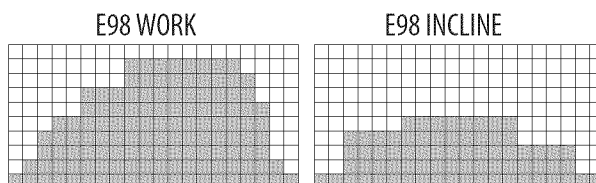

Interval

The **Interval** program takes you through high levels of intensity followed by periods of low intensity. This program increases your endurance by depleting your oxygen level followed by periods of recovery to replenish oxygen. Your cardiovascular system gets programmed to use oxygen more efficiently this way. This program also forces your body to become more efficient due to spikes in heart rate, between recovery periods. This aids in heart rate recovery from intense activities.

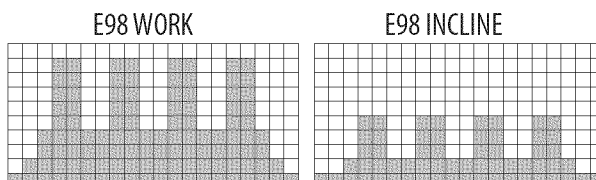

PROGRAMMING PRESET BUTTONS

1. Press the desired program button then press the **Enter** key.
2. The message window will ask you to enter your **Age**. You may adjust the age setting, using the **Incline** or **Resistance** Up and Down keys, then press the **Enter** key to accept the new number and proceed on to the next screen.
3. You are now asked to enter your **Weight**. You may adjust your weight using the **Incline** or **Resistance** Up and Down keys then press **Enter** to continue.
4. Next is **Time**. You may adjust the **Time** and press **Enter** to continue.
5. Now you are asked to adjust the **Max Level**. This is the peak exertion level you will experience during the program (the highest colored segment/box of the program profile). Adjust the level and then press **Enter**.
6. Now you are asked if you want to turn off the incline profile. Use the **Incline** Up or Down keys to turn the **Incline** on or off then press **Enter**.
7. Now you are finished editing the settings and can begin your workout by pressing the **Start** key. You can also go back and modify your settings by pressing the **Stop** key to go back one screen or **Enter** to go back to the beginning.
8. If you want to increase or decrease the resistance or incline at any time during the program press the **Incline** or **Resistance** Up or Down keys.
9. During the program you will be able to scroll through the data in the message window by pressing the **Display** key.
10. When the program ends the message window will show a summary of your workout. The summary will be displayed for a short time then the console will return to the start-up display.

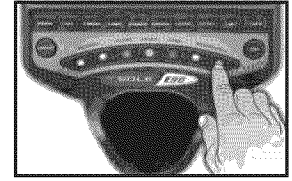

CUSTOM PROGRAM

The customizable User program allows you to build and save your own workout. Follow the instructions below.

1. Select the **Custom** program then press **Enter**. If you have already saved a program, it will be displayed and you are ready to begin. If not or someone else's name is shown, you will have the option of overriding or inputting a username. In the message window, the letter "A" will be blinking. Use the Up and Down **Incline** or **Resistance** buttons to select the appropriate first letter of your name (pressing the Up button will switch to the letter "B"; pressing the Down button will switch to letter "Z"). Press **Enter** when the desired letter is displayed. Repeat this process until all of the characters of your name have been programmed (maximum 7 characters). When finished press **Stop**.
2. If there is a program already stored in **Custom** when you press the key, you will have an option to run the program as it is or delete the program and build a new one. At the welcome message screen, when pressing **Start** or **Enter** you will be prompted: Run Program? Use the Up/Down arrows to select Yes or No. If you select No, you will then be asked if you want to delete the currently saved program. It is necessary to delete the current program if you want to build a new one.
3. The message window will ask you to enter your **Age**. You may enter your weight using the **Incline** or **Resistance** Up and Down keys, then press the **Enter** key to accept the new number and proceed on to the next screen.
4. You are now asked to enter your **Weight**. You may adjust the age number using the **Incline** or **Resistance** Up and Down keys, then press **Enter** to continue.
5. Next is **Time**. You may adjust the **Time** using the **Incline** or **Resistance** Up and Down keys and press **Enter** to continue.
6. Now the first column will be blinking and you are asked to adjust the level for the first segment of the workout. When you finish adjusting the first segment, or if you don't want to change, then press **Enter** to continue to the next segment. The next segment will show the same level as the previously adjusted segment. Repeat the same process as the last segment then press **Enter**. Continue this process until all twenty segments have been set.
7. Now the first column will be blinking again and you are asked to adjust the Incline level for the first segment of the workout. Follow the same procedure for building the Incline profile as you did for the resistance profile.
8. The message window will then tell you to start to begin (and save the program) or **Enter** to modify the program. Pressing **Stop** will exit to the start up screen.
9. If you want to increase or decrease the workload at any time during the program press the **Incline** or **Resistance** Up or Down key. This will only affect the **Incline** or **Resistance** for the present column in the profile. When the profile changes to the next column it will return to the preset work level.
10. During the **Custom** program you will be able to scroll through the data in the message window by pressing the **Display** key.
11. When the program ends the message window will show a summary of your workout. The summary will be displayed for a short time then the console will return to the start-up display.

FITNESS TEST PROGRAM

The fitness test will assess your fitness level and give a score at the end of the test. This score is not a Vo2 max number, but just a number to use as a reference. You can take the test every month and the score should be higher as your level of fitness improves. The test will take anywhere from 6–15 minutes. The test will ask you to maintain a pedal speed of 50 RPM and will automatically make adjustments to the work load depending on your heart rate response to set work levels. The test ends when you reach your target heart rate which is 85% of your maximum heart rate (Max HR = 220 – your age) or if your HR exceeds 110 BPM for 2 consecutive stages.

Fitness Test Programming

1. Press the **Fit-test** button and press **Enter**.
2. The message window will ask you to enter your **Age**. You may adjust the age setting, using the **Resistance** Up and Down keys then press the **Enter** key to accept the new number and proceed on to the next screen.
3. You are now asked to enter your **Weight**. You may adjust the weight number using the **Resistance** Up and Down keys then press enter to continue.
4. Now press **Start** to begin the test or **Enter** to modify your settings.

Before the test

- Make sure you are in good health; check with your physician before performing any exercise if you are over the age of 35 or persons with pre-existing health conditions.
- Make sure you have warmed up and stretched before taking the test.
- Do not take in caffeine before the test.
- Hold the hand grips gently, do not tense up.

During the test

- The console must be receiving a steady heart rate for the test to begin. You may use the hand pulse sensors or wear a heart rate chest strap transmitter.
- You must maintain a steady 50 RPM pedal speed. If your pedal speed drops below 48 RPM or goes above 52 RPM the console will emit a steady beeping sound until you are within this range.
- You may scroll through the various data readings in the message window by pressing the Display button under the message window.
 1. The message window will always display your pedal speed on the right side to help you maintain 50RPM.
 2. The data shown during the test is:
 - a. Work in KGM is actually an abbreviated form of kg-m/min. which is a work measurement of kilogram-force meter/minute
 - b. Work in Watts (1 watt is equal to 6.11829727787 kg-m/min.)
 - c. HR is your actual heart rate; TGT is the target heart rate to reach to end the test.
 - d. Time is the total elapsed time of the test.

After the test

- Cool down for about one to three minutes.
- Take note of your score because the console will automatically return to the start-up mode after a few minutes.

| | | 1st Stage | Level 1 (10W) 60 kgm/min | |
|------------|--------------------------------|--------------------------------|-------------------------------|-------------------------------|
| Heart Rate | HR<80 | HR: 80-90 | HR: 90-100 | HR>100 |
| 2nd Stage | Level 18 (80W) 480 kgm/min | Level 13 (61W) 366 kgm/min | Level 8 (44W) 264 kgm/min | Level 4 (28W) 168 kgm/min |
| 3rd Stage | Level 23 (107W) 642 kgm/min | Level 18 (80W) 480 kgm/min | Level 13 (61W) 366 kgm/min | Level 8 (44W) 264 kgm/min |
| 4th Stage | Level 25 (124W) 744 kgm/min | Level 23 (107W) 642 kgm/min | Level 17 (76W) 456 kgm/min | Level 13 (61W) 366 kgm/min |

HEART RATE PROGRAMS

Before we get started, a word about Heart Rate:

The old motto, "no pain, no gain", is a myth that has been overpowered by the benefits of exercising comfortably. A great deal of this success has been promoted by the use of heart rate monitors. With the proper use of a heart rate monitor, many people find that their usual choice of exercise intensity was either too high or too low and exercise is much more enjoyable by maintaining their heart rate in the desired benefit range.

To determine the benefit range in which you wish to train, you must first determine your Maximum Heart Rate. This can be accomplished by using the following formula: 220 minus your age. This will give you the Maximum Heart Rate (MHR) for someone of your age. To determine the effective heart rate range for specific goals you simply calculate a percentage your MHR. Your Heart rate training zone is 50% to 90% of your maximum heart rate. 60% of your MHR is the zone that burns fat while 80% is for strengthening the cardio vascular system. This 60% to 80% is the zone to stay in for maximum benefit.

For someone who is 40 years old their target heart rate zone is calculated:

$$220 - 40 = 180 \text{ (maximum heart rate)}$$

$$180 \times .6 = 108 \text{ beats per minute}$$

(60% of maximum)

$$180 \times .8 = 144 \text{ beats per minute}$$

(80% of maximum)

So for a 40 year old the training zone would be 108 to 144 beats per minute.

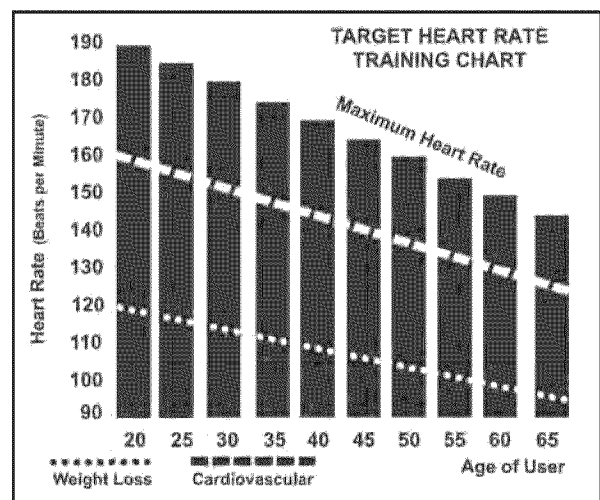

If you enter your age during programming the console will perform this calculation automatically. Entering your age is used for the Heart Rate control programs. After calculating your MHR you can decide upon which goal you would like to pursue.

The two most popular reasons for, or goals, of exercise are cardiovascular fitness (training for the heart and lungs) and weight control. The black columns on the chart above represent the MHR for a person whose age is listed at the bottom of each column. The training heart rate, for either cardiovascular fitness or weight loss, is represented by two different lines that cut diagonally through the chart. A definition of the lines' goal is in the bottom left-hand corner of the chart. If your goal is cardiovascular fitness or if it is weight loss, it can be achieved by training at 80% or 60%, respectively, of your MHR on a schedule approved by your physician. Consult your physician before participating in any exercise program.

With all SOLE Heart Rate Control elliptical machines you may use the heart rate monitor feature without using the Heart Rate Control program. This function can be used during manual mode or during any of the nine different programs. The Heart Rate Control program automatically controls resistance at the pedals.

RATE OF PERCEIVED EXERTION

Heart rate is important but listening to your body also has a lot of advantages. There are more variables involved in how hard you should workout than just heart rate. Your stress level, physical health, emotional health, temperature, humidity, the time of day, the last time you ate and what you ate, all contribute to the intensity at which you should workout. If you listen to your body, it will tell you all of these things.

The rate of perceived exertion (RPE), also know as the Borg scale, was developed by Swedish physiologist G.A.V. Borg. This scale rates exercise intensity from 6 to 20 depending upon how you feel or the perception of your effort.

The scale is as follows:

Rating Perception of Effort

- 6 Minimal
- 7 Very,very light
- 8 Very,very light +
- 9 Very light
- 10 Very light +
- 11 Fairly light
- 12 Comfortable
- 13 Somewhat hard
- 14 Somewhat hard +
- 15 Hard
- 16 Hard +
- 17 Very hard
- 18 Very hard +
- 19 Very,very hard
- 20 Maximal

You can get an approximate heart rate level for each rating by simply adding a zero to each rating. For example a rating of 12 will result in an approximate heart rate of 120 beats per minute. Your RPE will vary depending up the factors discussed earlier. That is the major benefit of this type of training. If your body is strong and rested, you will feel strong and your pace will feel easier. When your body is in this condition, you are able to train harder and the RPE will support this. If you are feeling tired and sluggish, it is because your body needs a break. In this condition, your pace will feel harder. Again, this will show up in your RPE and you will train at the proper level for that day.

USING HEART RATE TRANSMITTER (SOLD SEPARATELY)

How to wear your wireless chest strap transmitter:

1. Attach the transmitter to the elastic strap using the locking parts.
2. Adjust the strap as tightly as possible as long as the strap is not too tight to remain comfortable.
3. Position the transmitter with the logo centered in the middle of your body facing away from your chest (some people must position the transmitter slightly left of center). Attach the final end of the elastic strap by inserting the round end and, using the locking parts, secure the transmitter and strap around your chest.
4. Position the transmitter immediately below the pectoral muscles.
5. Sweat is the best conductor to measure very minute heart beat electrical signals. However, plain water can also be used to pre-wet the electrodes (2 ribbed oval areas on the reverse side of the belt and both sides of the transmitter). It's also recommended that you wear the transmitter strap a few minutes before your work out. Some users, because of body chemistry, have a more difficult time in achieving a strong, steady signal at the beginning. After "warming up", this problem lessens. As noted, wearing clothing over the transmitter/strap doesn't affect performance.
6. Your workout must be within range - distance between transmitter/receiver – to achieve a strong steady signal. The length of range may vary somewhat but generally stay close enough to the console to maintain good, strong, reliable readings. Wearing the transmitter immediately against bare skin assures you of proper operation. If you wish, you may wear the transmitter over a shirt. To do so, moisten the areas of the shirt that the electrodes will rest upon.

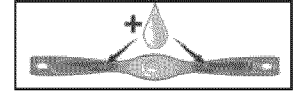
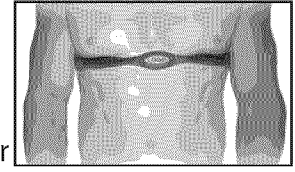

Note: The transmitter is automatically activated when it detects activity from the user's heart. Additionally, it automatically deactivates when it does not receive any activity. Although the transmitter is water resistant, moisture can have the effect of creating false signals, so you should take precautions to completely dry the transmitter after use to prolong battery life (estimated transmitter battery life is 2500 hours). The replacement battery is Panasonic CR2032.

ERRATIC OPERATION

Caution! Do not use this elliptical for Heart Rate Control unless a steady, solid Actual Heart Rate value is being displayed. High, wild, random numbers being displayed indicate a problem.

Areas to look for interference which may cause erratic heart rate:

1. Microwave ovens, TV's, small appliances, etc.
2. Fluorescent lights.
3. Some household security systems.
4. Perimeter fence for a pet.
5. Some people have problems with the transmitter picking up a signal from their skin. If you have problems try wearing the transmitter upside down. Normally the transmitter will be oriented so the logo is right side up.
6. The antenna that picks up your heart rate is very sensitive. If there is an outside noise source, turning the whole machine 90 degrees may de-tune the interference.
7. Another Individual wearing a transmitter within 3' of your machine's console.

If you continue to experience problems contact your dealer.

HEART RATE CONTROL PROGRAM OPERATION

Both programs operate the same, the only difference is that **HR1** is set to 60% and **HR2** is set to 80% of the maximum heart rate. They both are programmed the same way.

To start an **HR** program follow the instructions below or just select the **HR1** or **HR2** program, then the **Enter** button and follow the directions in the message window.

1. Press the **HR1** or **HR2** key then press the **Enter** key.
2. The message window will ask you to enter your **Age**. You may enter your **Age**, using the Up and Down keys, then press the **Enter** key to accept the new number and proceed on to the next screen.
3. You are now asked to enter your **Weight**. You may adjust the **Weight** number using the Up and Down keys, then press **Enter** to continue.
4. Next is **Time**. You may adjust the **Time** and press **Enter** to continue.
5. Now you are asked to adjust your **Target Heart Rate**. This is the heart rate level you will strive to reach and maintain during the program. Adjust the level and then press **Enter**.
NOTE: The heart rate that appears is based on the % you accepted in Step 1. If you change this number it will either increase or decrease the % from Step 1.
6. Now you are finished editing the settings and can begin your workout by pressing the **Start** key. You can also go back and modify your settings by pressing the **Enter** key.
NOTE: At any time during the editing of Data you can press the Stop key to go back one level, or screen.
7. If you want to increase or decrease the workload at any time during the program press the Up or Down key. This will allow you to change your target heart rate at any time during the program.
8. During the **HR1** or **HR2** programs you will be able to scroll through the data in the message window by pressing the adjacent **Display** key.
9. When the program ends you may press **Start** to begin the same program again or Stop to exit the program or you can save the program you just completed as a **Custom Program** by pressing the **Custom** key and following the instructions in the message window.

GENERAL MAINTENANCE

1. Wipe down all areas in the sweat path with a damp cloth after each workout.
2. If a squeak, thump, clicking or rough feeling develops the main cause is most likely one of two reasons:
 - I. The hardware was not sufficiently tightened during assembly. All bolts that were installed during assembly need to be tightened as much as possible. It may be necessary to use a larger wrench than the one provided if you cannot tighten the bolts sufficiently. I cannot stress this point enough; 90% of calls to the service department for noise issues can be traced to loose hardware or the rear rails being dirty.
 - II. Dirt build-up on the rear rails and polyurethane wheels are also a source of noise. Noise from build-up on the rails can cause a thumping sound that you would swear is coming from inside the main body of the machine because noise travels, and is amplified in the tubing of the frame. Clean the rails and wheels with a lint free cloth and rubbing alcohol. Stubborn build-up can be removed with your thumbnail or a non-metallic scraper, like the back edge of a plastic knife. After cleaning, apply a small amount of lubricant on the rails with your fingers or a lint free cloth. You only need a thin coat of lubrication, wipe off any excess.
3. If squeaks or other noises persist, check that the unit is properly leveled before calling the service department.

MAINTENANCE MENU IN CONSOLE SOFTWARE

1. Press and hold the **Start**, **Stop** and **Enter** key at the same time, until the display shows "Maintenance Menu". Press the **Enter** key.
2. You can now scroll through the menu using the **Resistance** Up/Down keys. Use the **Stop** key to return to previous menu selection. The menu selections are:
 - A. **Key Test**
 - B. **Display Test**
 - C. **Functions**
 - I. **Display Mode** - Turn on to have the console power down automatically after 30 minutes of inactivity
 - II. **Pause Mode** - Turned on to allow 5 minutes of pause, turn off to have console pause in definitely
 - III. **ODO Reset** - Resets the Odometer reading to zero
 - IV. **Units** - Choose from English(Imperial) or Metric display readings
 - V. **PWM Test** - For testing the Brake function
 - D. **Factory Settings**
 - E. **Exit**

Incline Calibration: If there is a problem with the incline, try running the calibration. Press the **Incline** Up key and the **Start** key at the same time. Hold them down for 5 seconds and the Incline calibration will start and run automatically. If the problem persists contact Sole service department.

MANUFACTURER'S LIMITED WARRANTY

ELLIPTICAL WARRANTY

Effective January 1, 2011

SOLE warrants all its ellipticals' parts for a period of time listed below from the date of retail sale, as determined by sale receipt, or in the absence of a sales receipt eighteen (18) months from the original factory shipping date. SOLE's responsibilities include providing new or remanufactured parts, at SOLE's option, and technical support to our independent dealers and servicing organizations. In the absence of a dealer or service organization, these warranties will be administered by SOLE directly to a consumer. The warranty period applies to the following components:

COMMERCIAL (5 Hours or less use per day)

| | |
|-------|----------|
| Frame | Lifetime |
| Brake | 5 Years |
| Parts | 3 Years |
| Labor | 1 Year |

RESIDENTIAL

| | |
|---------------|----------|
| Frame & Brake | Lifetime |
| Parts | 5 Years |
| Labor | 2 Years |

NORMAL RESPONSIBILITIES OF THE CONSUMER

This warranty applies only to products in ordinary household use or in a non-dues paying, light commercial facility with 5 hours elliptical use or less per day. The consumer or light commercial facility is responsible for the items listed below:

1. The warranty registration card must be completed and returned to the address listed on the card within 10 days of the original purchase to validate the manufacturer's limited warranty.
2. Proper use of the elliptical in accordance with the instructions provided in this manual
3. Proper installation in accordance with instructions provided with the elliptical and with all local electric codes.
4. Proper connection to a grounded power supply of sufficient voltage, replacement of blown fuses, repair of loose connections or defects in house wiring.
5. Expenses for making the elliptical accessible for servicing, including any item that was not part of the elliptical at the time it was shipped from the factory.
6. Damages to the elliptical finish during shipping, installation or following installation.
7. Routine maintenance of this unit as specified in this manual.

EXCLUSIONS

This warranty does not cover the following:

1. CONSEQUENTIAL, COLLATERAL, OR INCIDENTAL DAMAGES SUCH AS PROPERTY DAMAGE AND INCIDENTAL EXPENSES RESULTING FROM ANY BREACH OF THIS WRITTEN OR ANY IMPLIED WARRANTY.
Note: Some states do not allow the exclusion or limitation of incidental or consequential damages, so this limitation or exclusion may not apply to you.
2. Service call reimbursement to the consumer. Service call reimbursement to the dealer that does not involve malfunction or defects in workmanship or material, for units that are beyond the warranty period, for units that are beyond the service call reimbursement period, for elliptical not requiring component replacement, or elliptical not in ordinary household use.
3. Damages caused by services performed by persons other than authorized SOLE service companies; use of parts other than original SOLE parts; or external causes such as corrosion, discoloration of paint or plastic, alterations, modifications, abuse, misuse, accident, improper maintenance, inadequate power supply, or acts of God.
4. Products with original serial numbers that have been removed or altered.
5. Products that have been: sold, transferred, bartered, or given to a third party.
6. Products that do not have a warranty registration card on file at SOLE. SOLE reserves the right to request proof of purchase if no warranty record exists for the product.
7. THIS WARRANTY IS EXPRESSLY IN LIEU OF ALL OTHER WARRANTIES EXPRESSED OR IMPLIED, INCLUDING THE WARRANTIES OF MERCHANTABILITY AND/OR FITNESS FOR A PARTICULAR PURPOSE.
8. Product use in any environment other than a residential setting.
9. Warranties outside of North America may vary. Please contact your local dealer for details.

SERVICE

Keep your bill of sale. Twelve (12) months from the date on the bill of sale or eighteen (18) months from the date of factory shipping as determined by the serial number establishes the labor warranty period should service be required. If service is performed, it is in your best interest to obtain and keep all receipts. This written warranty gives you specific legal rights. You may also have other rights that vary from state to state. Service under this warranty must be obtained by following these steps, in order:

1. Contact your selling authorized SOLE dealer. OR
2. Submit all service requests including serial number, contact information and a brief description of the problem online at www.soletreadmills.com/technical.php?p=service.
3. If you have any questions about your new product or questions about the warranty contact SOLE Fitness at 1-866-780-SOLE (7653). If you have a technical problem with your new elliptical contact SOLE technical service at 866-MYSOLE1 (697-6531).
4. If no local service is available, SOLE will repair or replace the parts, at SOLE's option, within the warranty period at no charge for parts. All transportation costs, both to our factory and upon return to the owner, are the responsibility of the owner. The owner is responsible for adequate packaging upon return to SOLE. SOLE is not responsible for damages that occur during shipping. Make all freight damage claims with the appropriate freight carrier. DO NOT SHIP ANY UNIT TO OUR FACTORY WITHOUT A RETURN AUTHORIZATION NUMBER. All units arriving without a return authorization number will be refused.
5. For any further information, or to contact our service department by mail, send your correspondence to:

SOLE Fitness
P.O. Box 2037
Jonesboro, AR 72402-2037

Product features or specifications as described or illustrated are subject to change without notice. All warranties are made by SOLE.

