

SOLE

FITNESS



E35
Elliptical



E25
Elliptical

OWNER'S MANUAL

**PLEASE CAREFULLY READ THIS ENTIRE MANUAL BEFORE
OPERATING YOUR NEW ELLIPTICAL!**

Table of Contents

| | |
|---------------------------------------|----|
| Product Registration..... | 2 |
| Important Safety Instructions..... | 3 |
| Important Electrical Information..... | 4 |
| Important Operation Instructions..... | 5 |
| E25 Assembly Instructions..... | 6 |
| E35 Assembly Instructions..... | 15 |
| Operation of Your New Elliptical..... | 25 |
| Maintenance..... | 34 |
| Manufacturer's Limited Warranty..... | 35 |

ATTENTION-THIS ELLIPTICAL IS INTENDED FOR RESIDENTIAL USE ONLY AND IS WARRANTED FOR THAT APPLICATION. ANY OTHER APPLICATION VOIDS THIS WARRANTY IN ITS ENTIRETY.



**CONGRATULATIONS ON YOUR
NEW ELLIPTICAL AND WELCOME
TO THE SOLE FAMILY!**

Thank you for your purchase of this quality elliptical trainer from SOLE. Your new elliptical has been manufactured by one of the leading fitness manufacturers in the world and is backed by one of the most comprehensive warranties available. SOLE will do all we can to make your ownership experience as pleasant as possible for many years to come.

If you have any questions about your new product or questions about the warranty contact SOLE Fitness at 1-866-780-SOLE (7653). If you have a technical problem with your new elliptical contact SOLE technical service at 866-MYSOLE1 (697-6531)

Please take a moment at this time to record the name of the dealer, their telephone number, and the date of purchase below to make any future, needed contact easy. We appreciate your support and we will always remember that you are the reason that we are in business. Please complete and mail your registration card today and enjoy your new elliptical.

Yours in Health,
SOLE Fitness

Name of Dealer _____
Telephone Number of Dealer _____
Purchase Date _____

Product Registration

RECORD YOUR SERIAL NUMBER

Please record the Serial Number of this fitness product in the space provided below.

Serial Number _____

REGISTER YOUR PURCHASE

The self-addressed product registration card must be completed in full and returned to SOLE or visit www.Soletreadmills.com under the support tab to register online.

Important Safety Instructions

WARNING - Read all instructions before using this appliance.

These three warnings paragraphs are for E35 owners:

DANGER - To reduce the risk of electric shock disconnect your SOLE E35 elliptical from the electrical outlet prior to cleaning and/or service work.

WARNING - To reduce the risk of burns, fire, electric shock, or injury to persons, install the elliptical on a flat level surface with access to a nominal 110-volt, 15-amp grounded outlet with only the E35 elliptical plugged into the circuit..

DO NOT USE AN EXTENSION CORD UNLESS IT IS A 14AWG OR BETTER, WITH ONLY ONE OUTLET ON THE END: DO NOT ATTEMPT TO DISABLE THE GROUNDED PLUG BY USING IMPROPER ADAPTERS, OR IN ANY WAY MODIFY THE CORD SET. A serious shock or fire hazard may result along with computer malfunctions. See Grounding Instructions, page 4.

- Do not operate elliptical on deeply padded, plush or shag carpet. Damage to both the carpet and elliptical may result.
- Keep children away from the elliptical. There are obvious pinch points, moving parts and other caution areas that can cause harm.
- Keep hands away from all moving parts.
- Never operate the elliptical if it has a damaged cord or plug. If the elliptical is not working properly, call your dealer.
- Keep the cord away from heated surfaces.
- Do not operate where aerosol spray products are being used or where oxygen is being administered. Sparks from the motor could ignite a highly gaseous environment
- Never drop or insert any object into any openings.
- Do not use outdoors.
- To disconnect, turn all controls to the off position, then remove the plug from the outlet.
- Do not attempt to use your elliptical for any purpose other than for the purpose it is intended.
- The hand pulse sensors are not medical devices. Various factors, including the user's movement, may affect the accuracy of heart rate readings. The pulse sensors are intended only as exercise aids in determining heart rate trends in general.
- Wear proper shoes. High heels, dress shoes, sandals or bare feet are not suitable for use on your elliptical. Quality athletic shoes are recommended to avoid leg fatigue.

SAVE THESE INSTRUCTIONS - THINK SAFETY!

Important Electrical Information

WARNING!

- **NEVER** remove any cover without first disconnecting AC power supply.
- If A.C. voltage varies by ten percent (10%) or more, the performance of your elliptical may be affected. **Such conditions are not covered under your warranty.** If you suspect the voltage is low, contact your local power company or a licensed electrician for proper testing.
- **NEVER** expose this elliptical to rain or moisture. This product is **NOT** designed for use outdoors, near a pool or spa, or in any other environment that may cause the machine to get wet. The maximum operating temperature specification is 40 degrees C (104 F), and humidity is 95% non-condensing (no water drops forming on surfaces).

Grounding Instructions E35 only

This product must be grounded. If the E35's electrical system should malfunction or breakdown grounding provides a path of least resistance for electric current, reducing the risk of electric shock. This product is equipped with a cord having an equipment-grounding plug. The plug must be plugged into an appropriate outlet that is properly installed and grounded in accordance with all local codes and ordinances.

DANGER - Improper connection of the equipment-grounding conductor can result in a risk of electric shock. Check with a qualified electrician or serviceman if you are in doubt as to whether the product is properly grounded. Do not modify the plug provided with the product if it will not fit the outlet; have a proper outlet installed by a qualified electrician.

This product is for use on a nominal 110-volt circuit, and has a grounding plug that looks like the plug illustrated below. A temporary adapter that looks like the adapter illustrated below may be used to connect this plug to a 2-pole receptacle as shown below if a properly grounded outlet is not available. The temporary adapter should be used only until a properly grounded outlet, (shown below) can be installed by a qualified electrician. The green colored rigid ear-lug, or the like, extending from the adapter, must be connected to a permanent ground such as a properly grounded outlet box cover. Whenever the adapter is used, it must be held in place by a metal screw.

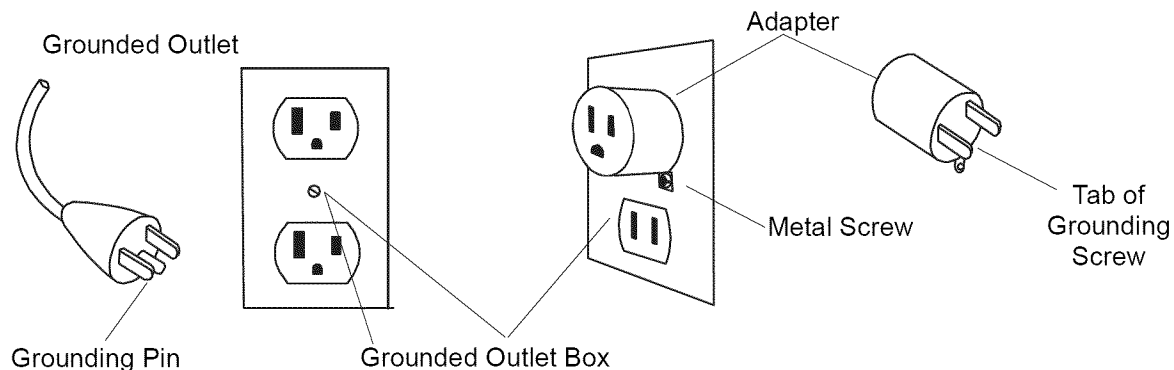

Important Operation Instructions

- **NEVER** operate this elliptical without reading and completely understanding the results of any operational change you request from the computer.
- Understand that changes in resistance do not occur immediately. Set your desired level on the computer console and release the adjustment key. The computer will obey the command gradually.
- **NEVER** use your elliptical during an electrical storm. Surges may occur in your household power supply due to lightening strikes that could damage elliptical components. Unplug the elliptical during an electrical storm as a precaution.
- Use caution while participating in other activities while using your elliptical such as watching television, reading, etc. These distractions may cause you to lose balance which may result in serious injury.
- Always hold on to a handrail or hand bar while making control changes.
Do not use excessive pressure on console control keys. They are precision set to properly function with little finger pressure. If you feel the buttons are not functioning properly with normal pressure, contact your SOLE dealer.

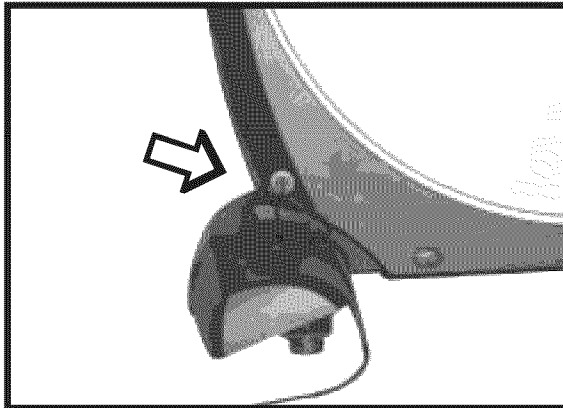

POWER CONNECTOR LOCATED ON FRONT, LEFT HAND SIDE OF UNIT.

Transportation

The elliptical is equipped with two transport wheels which are engaged when rear of the Elliptical is lifted.

Assembly Pack Check List for model E25 only

Step 1

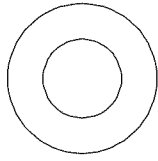

#142. 3/8" x 19 x 1.5T
Flat Washer (2pcs)

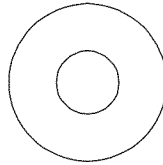

#157. 5/16" x 20x 1.5T
Flat Washer (4 pcs)

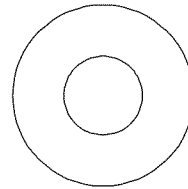

#156. 3/8" x 23 x 2T
Curved Washer (2pcs)

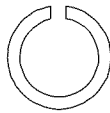

#155. 3/8" x 2T
Split Washer (1pc)

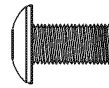

#117. M5 x10mm
Phillips Head Screw (4 pcs)



#134. 3/8" x 7T
Nylon Nut (2 pcs)



#158. ψ 5/16" x 1.5T
Split Washer (4pcs)

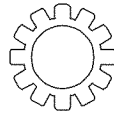

#151. ψ 5/16"
Star Washer (4pcs)

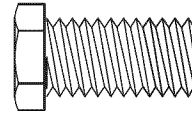

#106. 3/8" x 3/4"
Hex Head Bolt (2pcs)

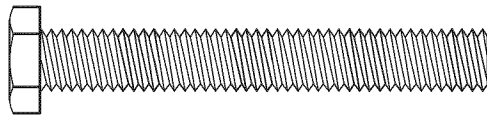

#108. 5/16" x 2-1/4"
Hex Head Bolt (4 pcs)

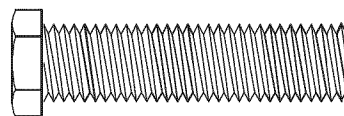

#107. 3/8" x 1-1/2"
Hex Head Bolt (2pcs)

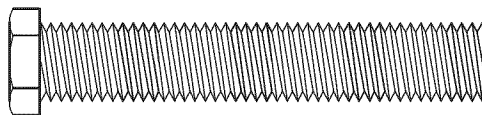

#101. 3/8" x 2-1/4"
Hex Head Bolt (1pc)

Step 2

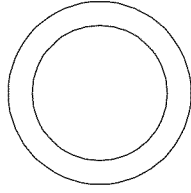

#153. \varnothing 17mm
Wave Washer (2 pcs)

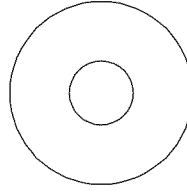

#145. 5/16" x 23 x 1.5T
Flat Washer (2 pcs)

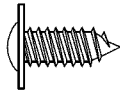

#126. \varnothing 3.5 x 12mm
Sheet Metal Screw (6 pcs)

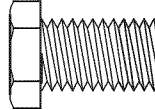

#100. 5/16" x 15mm
Hex Head Bolt (2 pcs)

Step 3

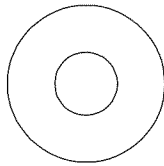

#151. 5/16" x 20 x 1.5T
Flat Washer (2 pcs)



#137. 5/16" x 7T
Nylon Nut (2 pcs)

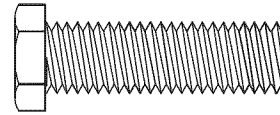

#109. 5/16" x 1-1/4"
Hex Head Bolt (2 pcs)

Step 4

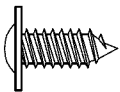

#126. \varnothing 3.5 x 12mm
Sheet Metal Screw (2pcs)

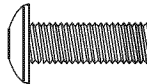

#115. M5 x 15mm
Phillips Head Screw (20 pcs)

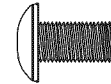

#125. M6 x 10mm
Phillips Head Screw (4 pcs)

Tools

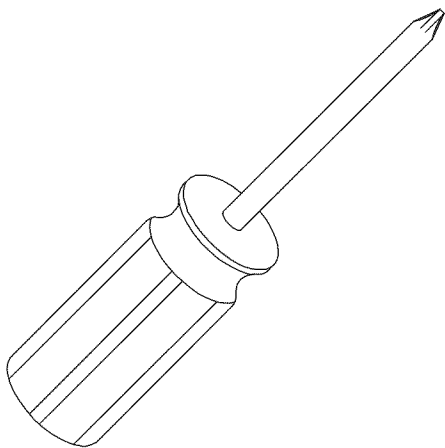

#161. Phillips Screw Driver (1 pc)

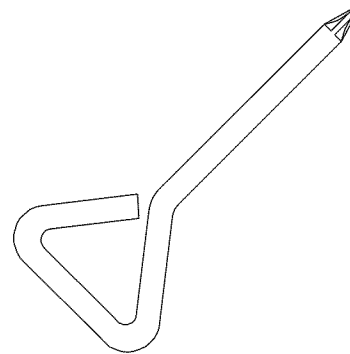

#160. Short Screw Driver (1 pc)

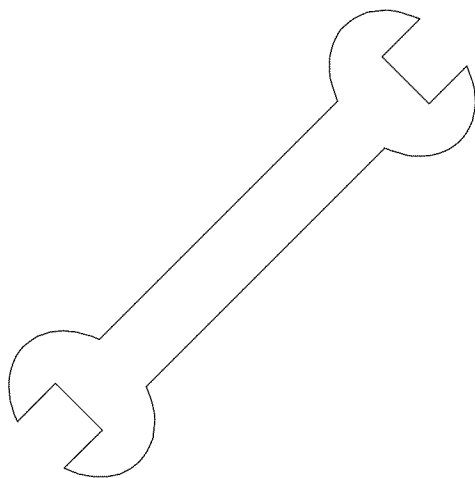

#162. 12/14 mm Wrench (1 pc)

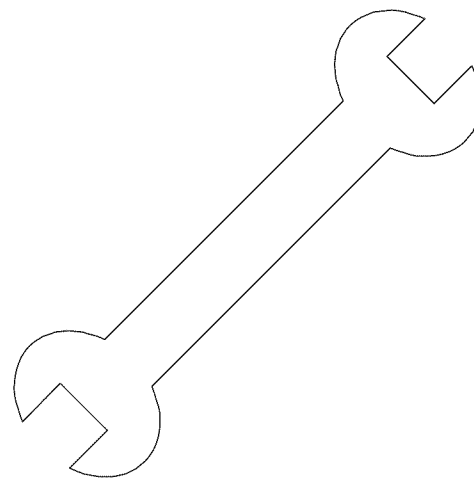

#159. 13/14mm Wrench (1pc)

Assembly Instructions for model E25

■ UNPACKING THE UNIT

1. Using a razor knife (Box Cutter) cut the outside, bottom, edge of box along the dotted Line. Lift Box over the unit and unpack.
2. Carefully remove all parts from carton and inspect for any damage or missing parts. If damaged parts are found, or parts are missing, contact your dealer immediately.
3. Locate the hardware package. The hardware is separated into four steps. Remove the tools first. Remove the hardware for each step as needed to avoid confusion. The numbers in the instructions that are in parenthesis (#) are the item number from the assembly drawing for reference.

STEP 1: Incline Rail Assembly and Console Mast

1. Install the Incline Rail Assembly (2) into the U-channel bracket of the Main Frame (1). Secure with the six bolts & associated hardware as follows: From the sides install two 3/8"x1-1/2" Hex Head Bolts (107) with two 3/8"x19mm Flat Washers (142) and two 3/8"x7T Nylon Nuts (134). From the top install four 5/16"x2-1/4" Hex Head Bolts (108), four 5/16" Split Washers (158), four 5/16"x20 Flat Washers (157) and four Star Washers (151), as shown in figure 1, and tighten with the 13/14 mm Wrench (159) and 12/14 mm Wrench (162).
2. Locate the Console Mast (12) and Console Mast Cover (72) and slide the Cover onto the Mast as far as it will go. Make sure the Console Mast Cover is facing the correct way. At the top opening of the Main Frame of the elliptical is a computer cable (47). Unravel and straighten out the cable and feed it into the bottom of the console mast tube and out of the top opening. Install the Console Mast (12) into the receiving bracket on the top of the Main Frame. Pull slightly on the computer cable at the top of the mast while installing. This will ensure the cable does not get pinched and shorted during console mast assembly.
3. Put one 3/8" x 2T Split Washer (155) onto the 3/8" x 2-1/4" Long Hex Head Bolt (101) and install through the left side of the receiving bracket into the Console Mast (12). Put the two 3/8" x 23 Curved Washers (156) onto the two 3/8" x 3/4" Short Hex Head Bolts (106) and install through the front of the console mast. Using the 13/14m/m Wrench, tighten the three bolts, and the fourth bolt which is pre-installed, firmly. These bolts should be tightened as much as you possibly can.
4. Plug all of the connectors into the back of the console; Computer Cable (47), two Hand pulse Cables (52) and Resistance switch wires (55). Secure the Console (46) on the console mounting plate with four M5x10m/m Phillips Head Screws (117).

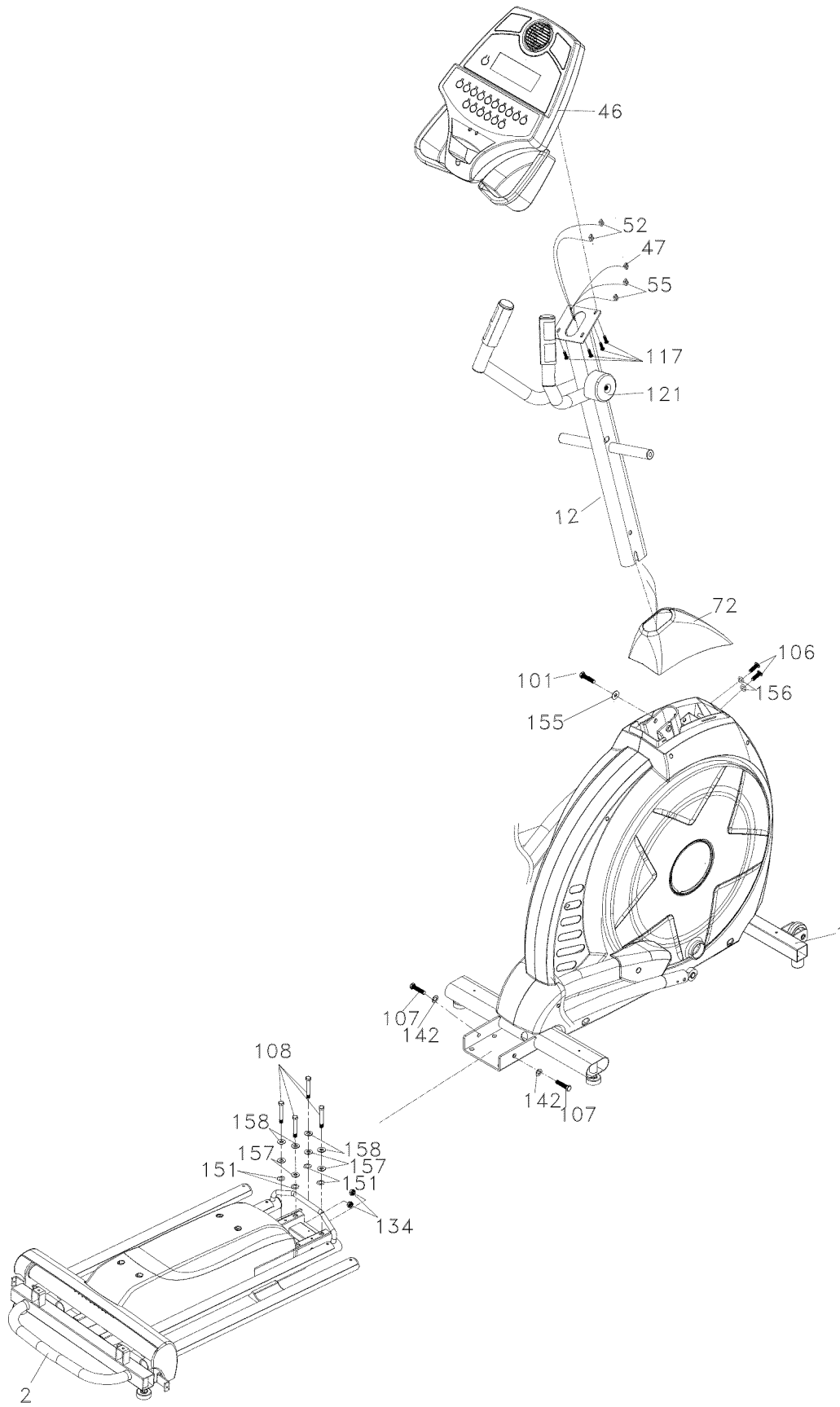

STEP 2: Handlebar Assembly

1. Install the two 17m/m Wave Washers (153) onto the Left and Right side of the Handle Bar axle.
2. Slide the Left (10) and Right (11) Handle Bars onto the appropriate side of the axle. The handlebars have a small sticker on them indicating **L** (left) and **R** (right).
3. Install two 5/16" Flat Washers (145) onto the two 5/16" X 15mm Hex Head Bolts (100) and install and tighten in the threaded holes in the ends of the axle.
4. Install the Front Handle Bar Covers (83 left, 85 right) and Rear Handle Bar Covers (84 left, 86 right) over the Handle Bar axle connections with the six 3.5x12m/m screws (126).

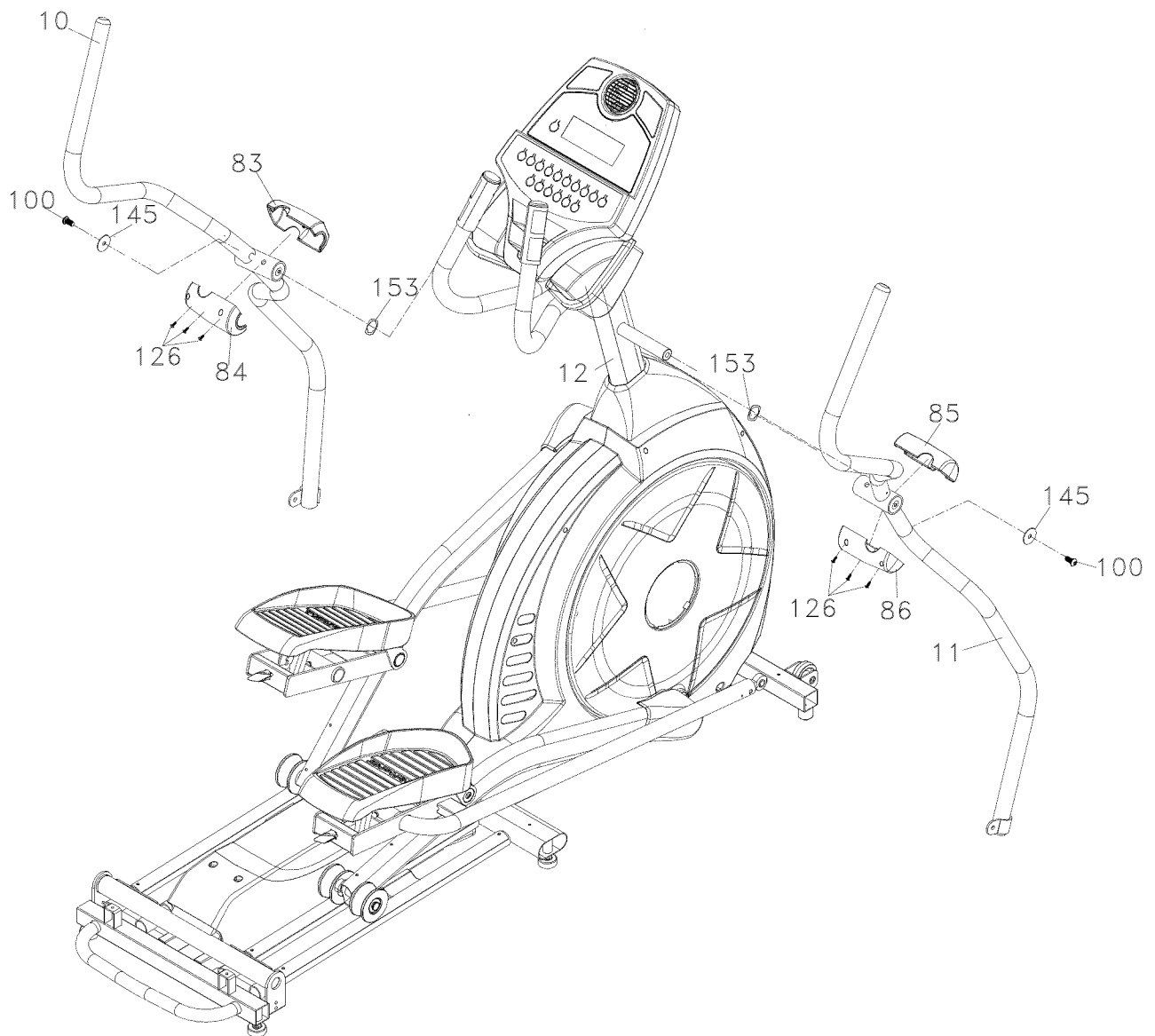

STEP 3: Connecting Arm Assembly

1. Untie the wire holding the Sleeve Spacer (25) in place on the rod-end bearings, located on the ends of the Connecting Arms (8&9). Align the hole in the rod ends with the hole in the brackets of the left and right Handle Bar (10&11). The rod end should be on the inside of the Handle Bar bracket. Secure with a 5/16"x1-1/4" Hex Head bolt (109), 5/16" x 20mm Flat Washer (151) and 5/16" Nylon Nut (137) by using 13/14 mm Wrench (159) and 12/14 mm Wrench (162).

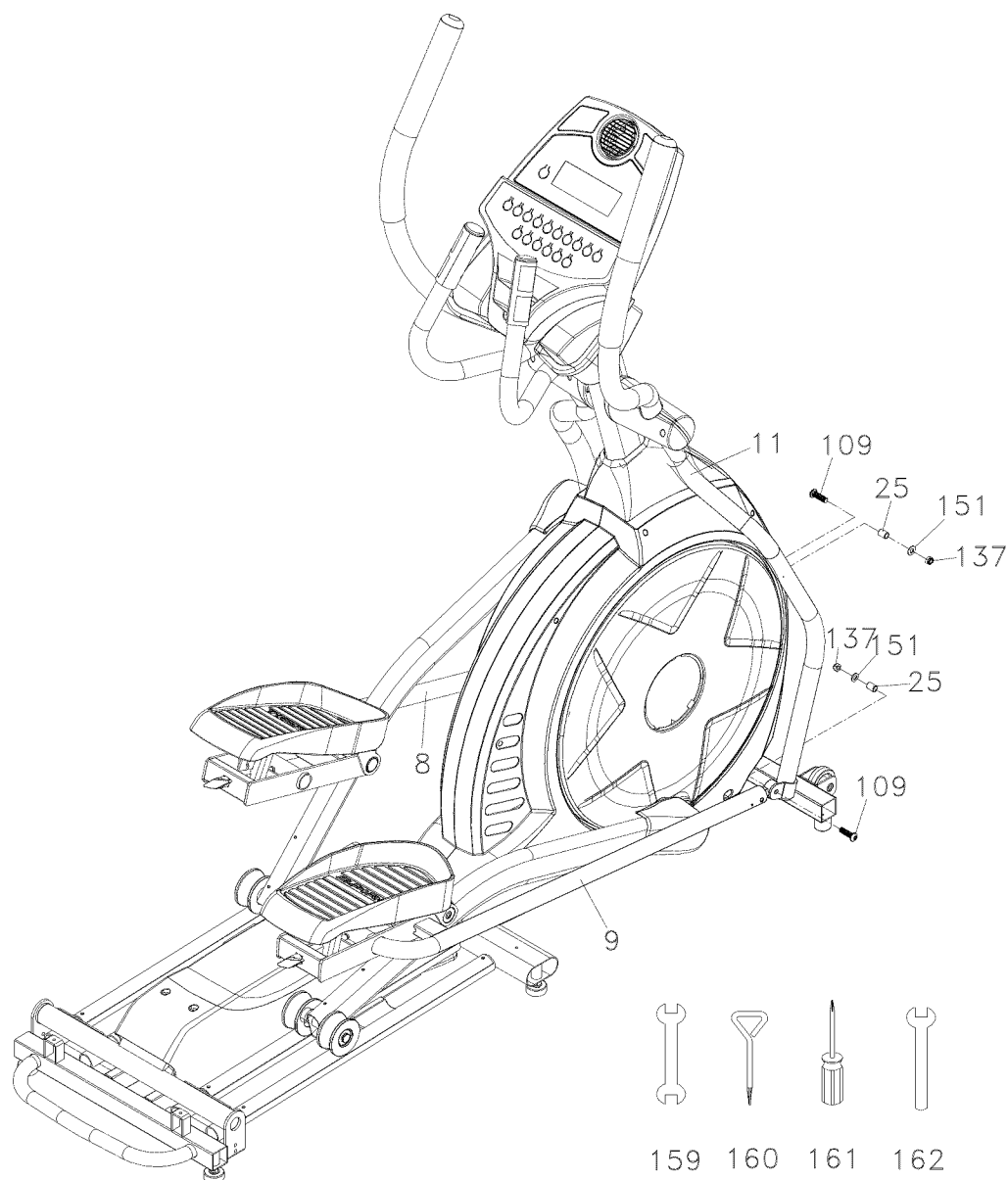

STEP 4: Plastic Parts Assembly

1. Match up the Connecting Arm Covers (71 and 72) and install onto the Left and Right Connecting Arms (8&9) and secure each side with two M5x15mm Phillips Head Screws (115) and one 3.5x12mm Sheet Metal Screws (126) by using Short Phillips Head Screw Driver (160).
2. Install Sliding Wheel Covers (82) on each side and secure with four M5x15mm Phillips Head Screws (115).
3. Install the two Stabilizer Covers (93) and (94) on the middle stabilizer bar with M5x15mm Phillips Head Screws (115).
4. Install the Front Stabilizer Cover (79) on the front stabilizer with two M5x15mm Phillips Head Screws (115).
5. Install the two Incline Cover brackets (27), with the hole for mounting the plastic cover on the bent tab facing rearward, and secure them on the Incline Rail Assembly with four M6x10mm Phillips Head Screws (125). Install the Rear Incline Bar Cover (91) on the rail base with two M5 x 15mm/m Screws (115).
6. Install the Rear Stabilizer Cover (92) on the Rear Stabilizer with four M5x15mm Phillips Head Screws (115).
7. This step to be performed after the elliptical power is plugged in. Run the incline to position 8 and install the incline Rail Front Cover (89) up against the Middle Stabilizer tube with two M5x15mm Phillips Head Screws (115).

Assembly Pack Check List for Model E35 only

Step 1

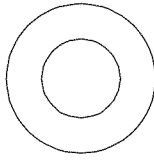

#164. 3/8" x 19 x 1.5T
Flat Washer (2pcs)

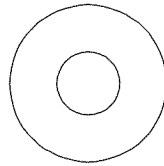

#170. 5/16" x 20x 1.5T
Flat Washer (4 pcs)

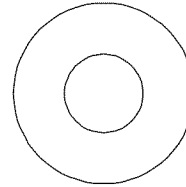

#181. 3/8" x 23 x 2T
Curved Washer (2pcs)

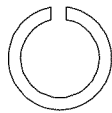

#180. 3/8" x 2T
Split Washer (1pc)

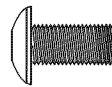

#141. M5x10m/m
Phillips Head Screw (4 pcs)



#157. 3/8" x 7T
Nylon Nut (2 pcs)



#182. ψ 5/16" x 1.5T
Split Washer (4pcs)

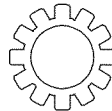

#183. ψ 5/16"
Star Washer (4pcs)

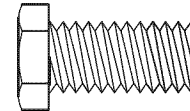

#132. 3/8" x 3/4"
Hex Head Bolt (2pcs)

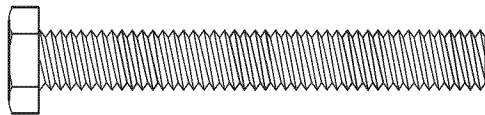

#135. 5/16" x 2-1/4"
Hex Head Bolt (4 pcs)

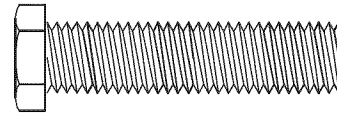

#133. 3/8" x 1-1/2"
Hex Head Bolt (2pcs)

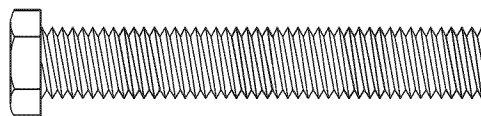

#125. 3/8" x 2-1/4"
Hex Head Bolt (1pc)

Step 2

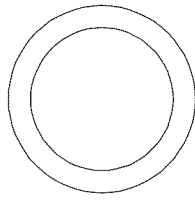

#175. 25 m/m
Wave Washer (2 pcs)

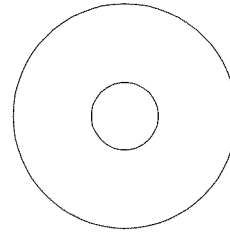

#165. 3/8" x 30 x 2.0T
Flat Washer (2 pcs)

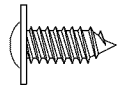

#142. ψ 3.5x12m/m
Sheet Metal Screw (8 pcs)

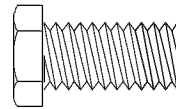

#132. 3/8" x 3/4"
Hex Head Bolt (2pcs)

Step 3

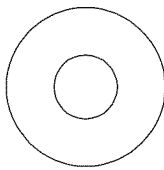

#170. 5/16" x 20 x 1.5T
Flat Washer (2 pcs)



#159. 5/16" x 7T
Nylon Nut (2 pcs)

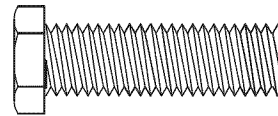

#134. 5/16" x 1-1/4"
Hex Head Bolt (2 pcs)

Step 4

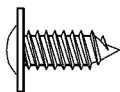

#142. ψ 3.5x12m/m
Sheet Metal Screw (8pcs)

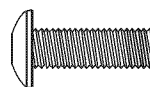

#139. M5 x 15m/m
Phillips Head Screw (24pcs)

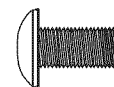

#145. M6 x 10m/m
Phillips Head Screw (4 pcs)

Tools

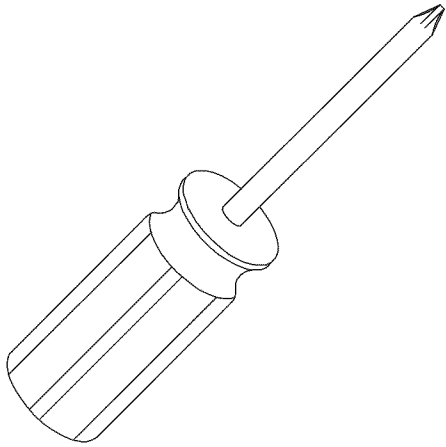

#186. Phillips Screw Driver (1 pc)

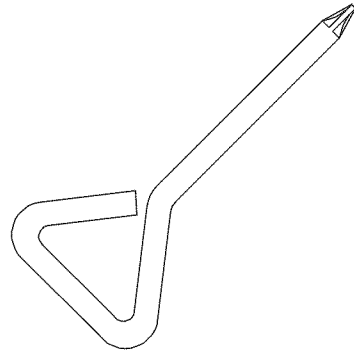

#185. Short Phillips Screw Driver (1 pc)

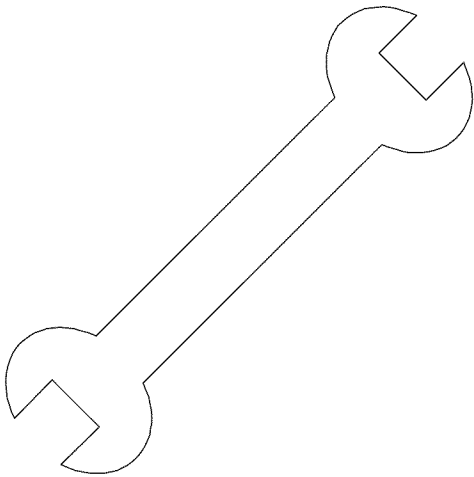

#187. 12 / 14 m/m Wrench (1 pc)

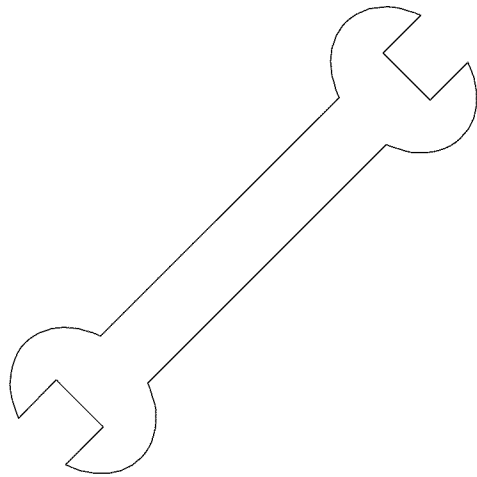

#184. 13 / 14m/m Wrench (1 pc)

Assembly Instructions for model E35

■ UNPACKING THE UNIT

1. Using a razor knife (Box Cutter) cut the outside, bottom, edge of box along the dotted Line. Lift Box over the unit and unpack.
2. Carefully remove all parts from carton and inspect for any damage or missing parts. If damaged parts are found, or parts are missing, contact your dealer immediately.
3. Locate the hardware package. The hardware is separated into four steps. Remove the tools first. Remove the hardware for each step as needed to avoid confusion. The numbers in the instructions that are in parenthesis (#) are the item number from the assembly drawing, for reference.

STEP 1: Incline Rail Assembly and Console Mast

1. Install the Incline Rail Assembly (2) into the U-channel bracket of the Main Frame (1). Secure with the six bolts & associated hardware as follows: From the sides install two 3/8"x1-1/2" Hex Head Bolts (133) with two 3/8"x19mm Flat Washers (164) and two 3/8"x7T Nylon Nuts (157). From the top install four 5/16"x2-1/4" Hex Head Bolts (135), four 5/16" Split Washers (182), four 5/16"x20 Flat Washers (170), and four 5/16" Star Washers (183), as shown in figure 1, and tighten with the 13/14 mm Wrench (184) and 12/14mm Wrench (187).
2. Connect the three Incline Motor Power lines by matching the Red, White and Black color codes of the wires (48) and the 3-pin position Sensor Connector (49). Locate the Console Mast (12) and Console Mast Cover (96) and slide the Cover onto the Mast as far as it will go. Make sure the Console Mast Cover is facing the correct way. At the top opening of the Main Frame of the elliptical is a Computer Cable (50). Unravel and straighten out the cable and feed it into the bottom of the console mast tube and out of the top opening. Install the Console Mast (12) into the receiving bracket on the top of the Main Frame (1). Pull slightly on the computer cable at the top of the mast while installing. This will ensure the cable does not get pinched and shorted during console mast assembly.
3. Put one 3/8" x 2T Split Washer (180) onto the 3/8" x 2-1/4" Long Hex Head Bolt (125) and install through the left side of the receiving bracket into the Console Mast (12). Put the two 3/8" x 23 Curved Washers (181) onto the two 3/8" x 3/4" Short Hex Head Bolts (132) and install through the front of the console mast. Using the 13/14m/m Wrench, tighten the three bolts, and the fourth bolt, which is pre-installed, firmly. These bolts should be tightened as much as you possibly can.
4. Plug all of the connectors into the back of the console; Computer Cable (50), two Hand pulse Cables (57), Resistance switch wire (60) and Incline switch wire (61). Secure the Console (45) on the console mounting plate with four M5x10m/m Phillips Head Screws (144).

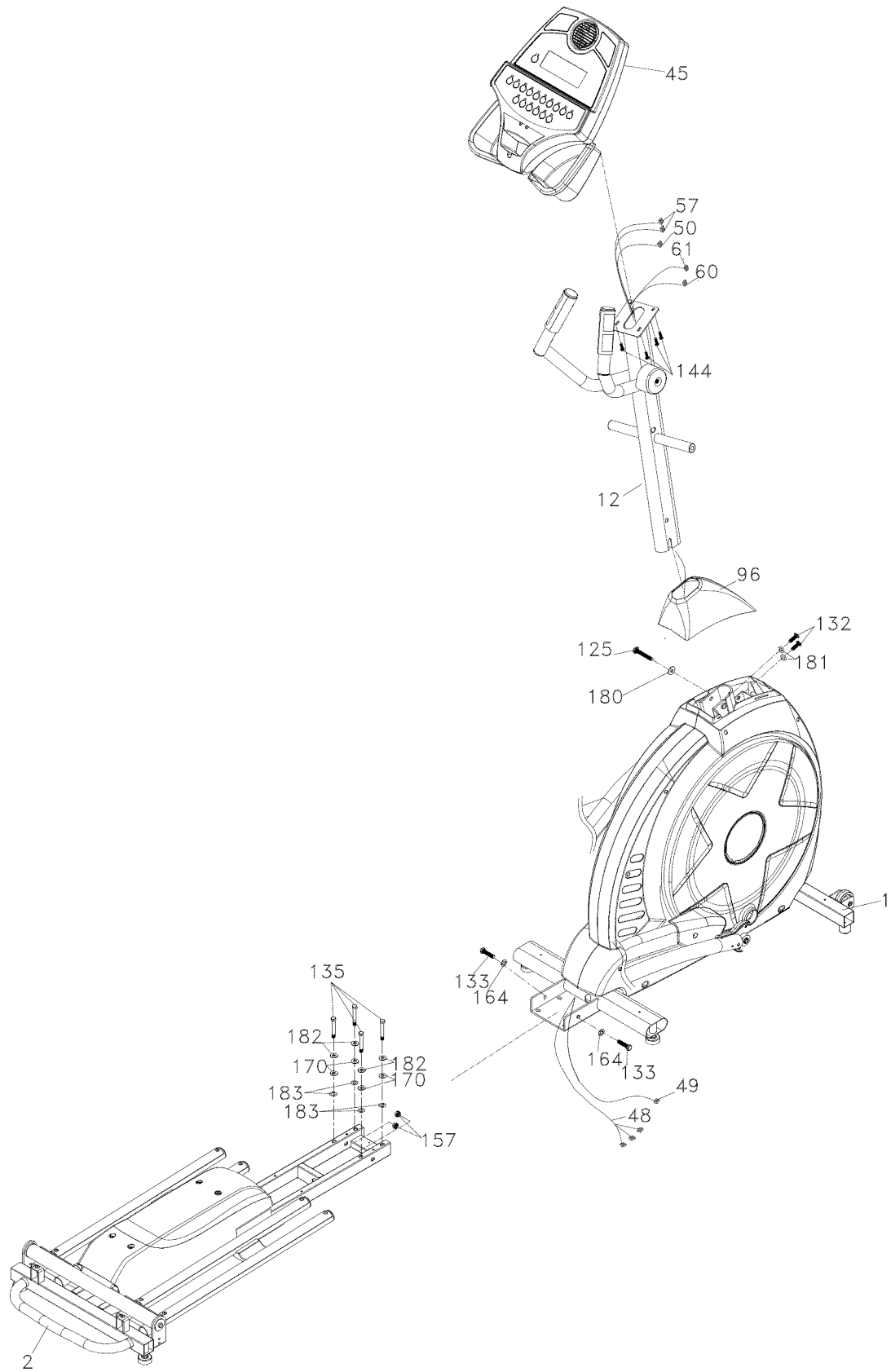

STEP 2: Handlebar Assembly

1. Install the two 25mm Wave Washers (175) onto the Left and Right side of the Handle Bar axle.
2. Slide the Left (10) and Right (11) Handle Bars onto the appropriate side of the axle. The handlebars have a small sticker on them indicating **L** (left) and **R** (right).
3. Install two 3/8 X 30mm Flat Washers (165) onto the two 3/8" X 3/4" Hex Head Bolts (132) and install, and tighten, in the threaded holes in the ends of the axle.
4. Connect the two wires (Left-61 to 63 & Right-60 to 62) on the L&R sides together and store the excess wire, including plastic connectors, back inside the console mast. Place the rubber grommets (75) over the wire and snap it into the hole in the console mast. Install the Front Handle Bar Covers (105 left, 107 right) and Rear Handle Bar Covers (106 left, 108 right) over the Handle Bar axle connections and secure with the eight 3.5x10mm Sheet Metal Screws (142).

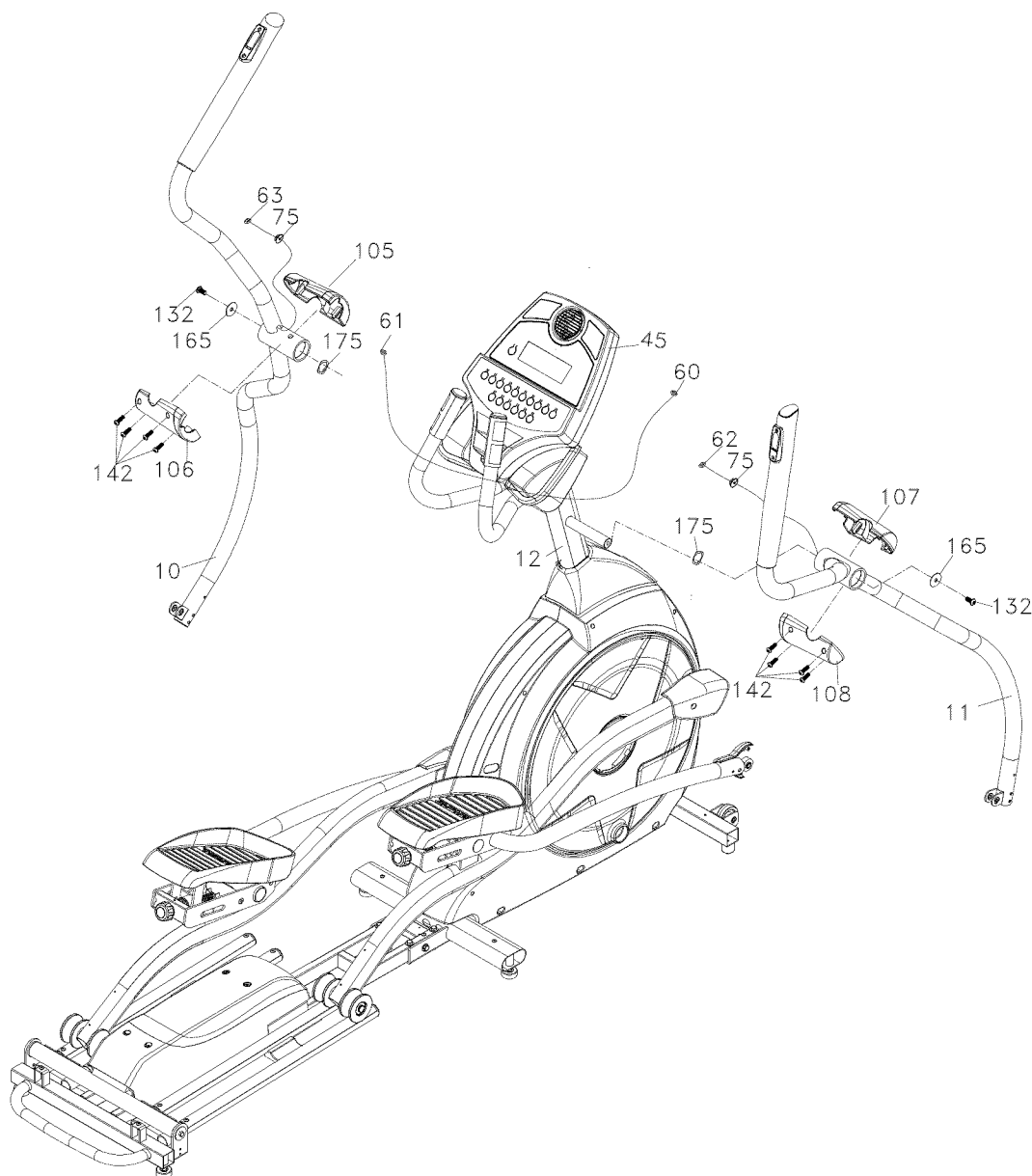

STEP 3: Connecting Arm Assembly

- ⑥ Untie the wire holding the Sleeve Spacer (24) in place on the rod-end bearings, located on the ends of the connecting arms (8&9). Align the hole in the rod ends with the hole in the brackets of the left and right Handle Bar (10&11). The rod end should be on the inside of the Handle Bar bracket. Secure both sides with a 5/16"x1-1/4" Hex Head Bolt (134), 5/16"x20mm Flat Washer (170) and 5/16" Nylon Nut (159) by using 13/14 mm Wrench (184) and 12/14 mm Wrench (187).

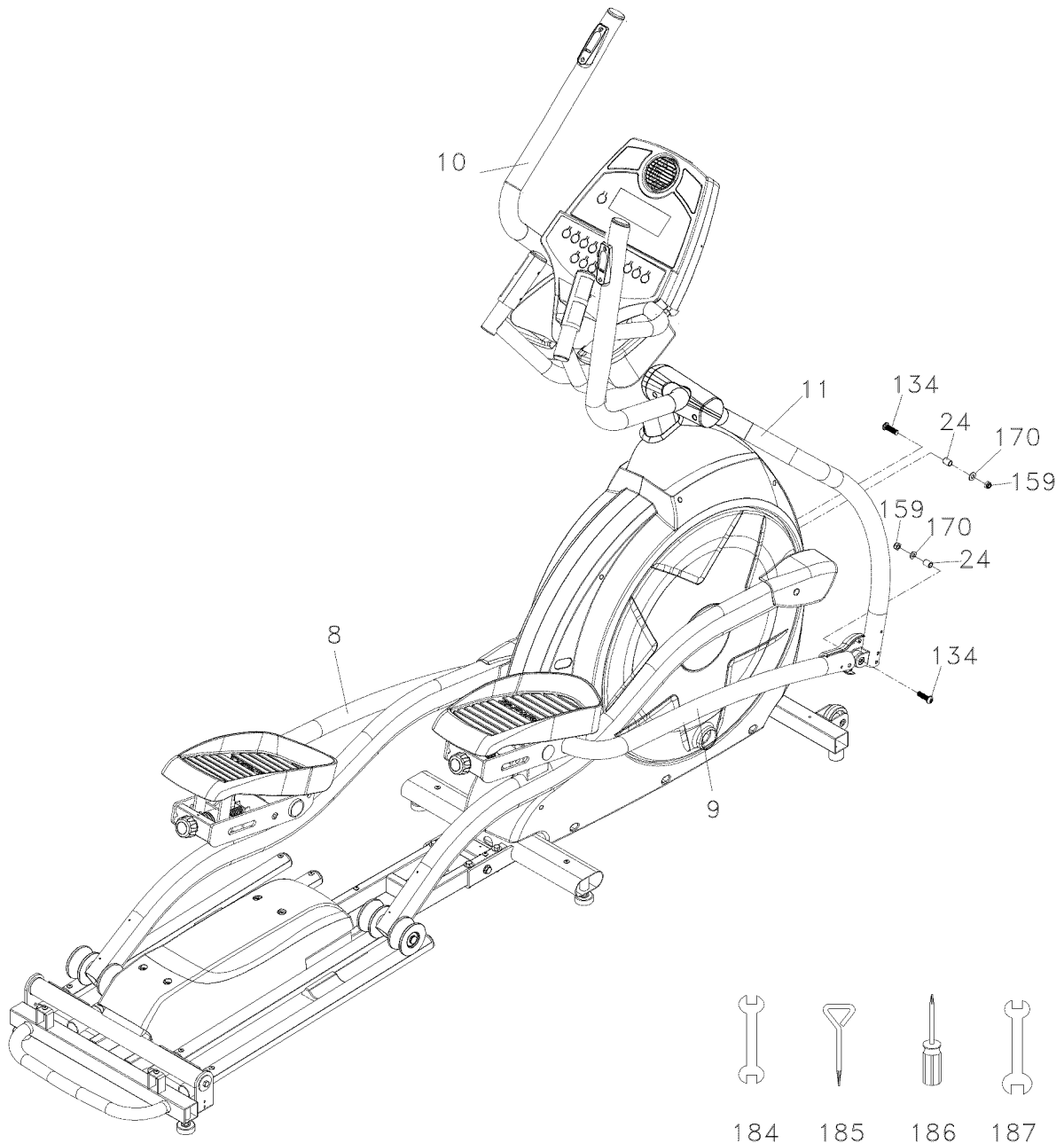

STEP 4: Plastic Parts Assembly

1. Match up the outer Connecting Arm Covers (part # 109&110) with the pre-installed inner connecting arm covers (P/N 111 & 112). Install the outer covers onto the Left and Right Connecting Arms (8&9) and secure each side with one M5x15mm Phillips Head Screw (139) and two 3.5x12mm Sheet Metal Screws (142) by using the Short Phillips Head Screw Driver (185).
2. Install Sliding Wheel Covers (104) on each side and secure with four M5x15mm Phillips Head Screws (139).
3. Install the two Stabilizer Covers (117 and 118) on the middle stabilizer bar with two M5x15mm Phillips Head Screws (139).
4. Install the Front Stabilizer Cover (103) on the front stabilizer with two M5x15mm Phillips Head Screws (139).
5. Install the two incline Cover brackets (25), with the hole for mounting the plastic cover on the bent tab facing rearward, and secure them on the Incline Rail Assembly (2) with four M6x10mm Phillips Head Screws (145). Install the Rear incline bar cover (115) on the rail base with two M5 x 15m/m Screws (139).
6. Install the Rear Stabilizer Cover (116) on the Rear Stabilizer with four M5x15mm Phillips Head Screws (139).
7. This step to be performed after the elliptical power is plugged in. Run the incline to position 8 and install the incline Rail front cover (113) up against the middle stabilizer tube with four M5x15mm Phillips Head Screws (139).

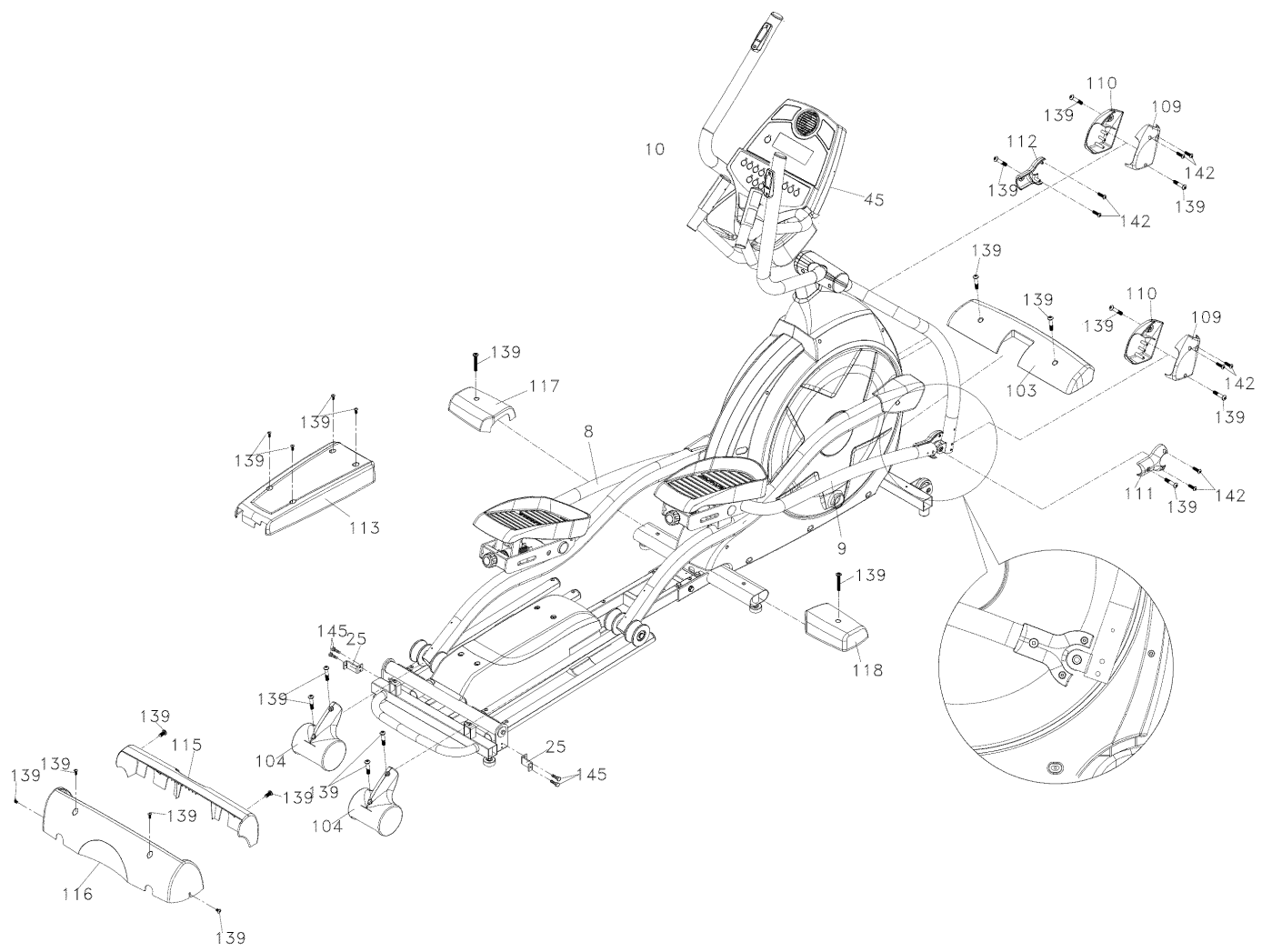

Features

Adjustable foot pedals, and correctly aligned orthopedic foot pads

Through research performed with a leading sports scientist and physical rehabilitation expert; SOLE engineering has developed a breakthrough in pedal design. No other elliptical, at any price, offers these unique features. The history of elliptical use over the past few years tells us that many users suffer from numb toes while working out on elliptical trainers. Many other users complain of ankle, Achilles tendon, knee and/or hip pain. While researching a solution to these common problems SOLE engineers consulted Richard DeKok, P.T., M.T.C., of St. Bernard's Industrial Rehabilitation Center in Jonesboro Arkansas. Together we identified the inherent problem in elliptical designs and developed solutions to solve the problems. What we found is that when you use an elliptical you tend to push outward during the power stroke and not just straight back. This causes stress on the outer part of the foot and throws off the natural alignment of the joints. The second problem we found is that many people tend to stay up on the ball of their foot during the elliptical motion. Our solutions were simple but effective:

- The first solution was to add a 2-degree inward angle to the footpads. This might sound simple but what it does is puts the users joints back into a neutral alignment. This eases the over stressing of the ankles, knees and hips.

The second solution was to make the foot pedal adjustable to the user's style of pedaling the elliptical. We achieved this by adding an adjustment that allows the angle of the footpad to be changed. Because everybody is different, and there are as many styles to pedal an elliptical as there are people, we found there is no one angle that fit every user. Some users would be up on the balls of their feet, resulting in numb toes, so we decided to let the user adjust the back of the foot pad upward to support the heel, taking the pressure off of the nerves in the balls of the feet and the Achilles tendon. The result was no more numb toes. Some users are uncomfortable at this angle so for them we designed in three different adjustable angles so they could find one that feels best for them.

- There are three footpad angle settings available by pulling on the red quick release handle under the rear of each footpad. The lowest setting will set the footpads at zero (0) degrees, or flat, at the bottom of the elliptical stroke. The second position sets the footpad to five (5) degrees and the top position sets the footpads to ten (10) degrees.

Ramp incline adjustment

Both the E25 & E35 Have an exciting new ramp incline feature that will further increase the variety of your workouts. When the incline is at its lowest position you get a normal elliptical workout. As the incline increases you will feel your knees rise higher with each step; which means you are involving more muscle groups.

The E25 has a manual incline, while the E35 has a computer controlled power incline. The E25 incline operates by lifting the bar at the front area of the incline rails. The incline is a ratchet type and will click into place as you raise it. There are 3 positions in total and at the top position, lifting the incline one more click will allow it to go back to the bottom. The E35 power incline is controlled by buttons on the console and swing arms and also automatically controlled during the built-in workout programs.

Operation of Your Elliptical

Getting familiar with the control panel

■ E25 Console

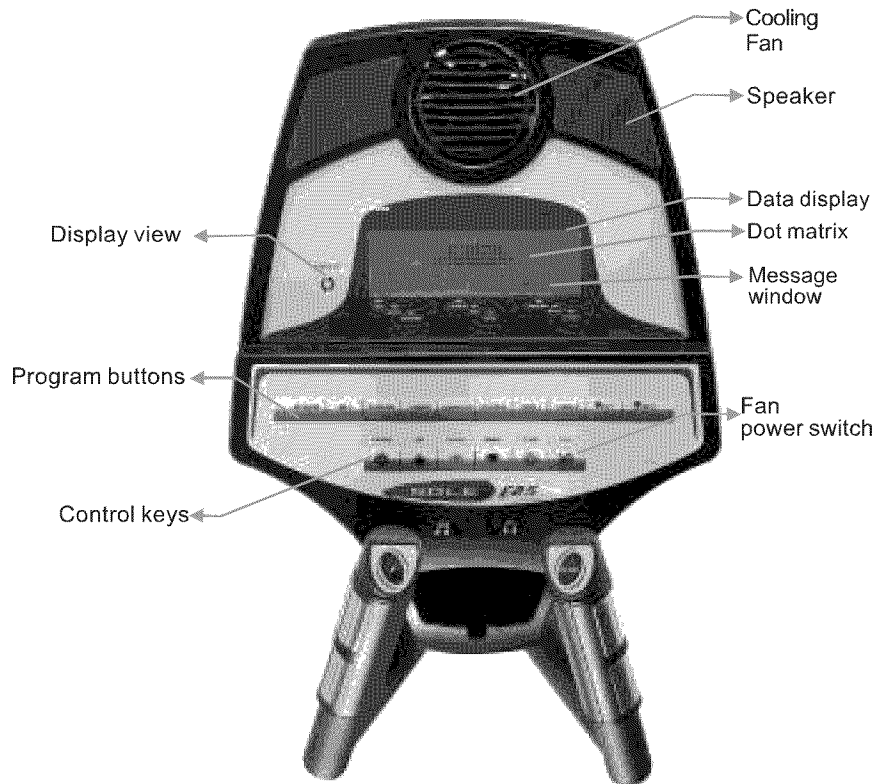

■ E35 Console

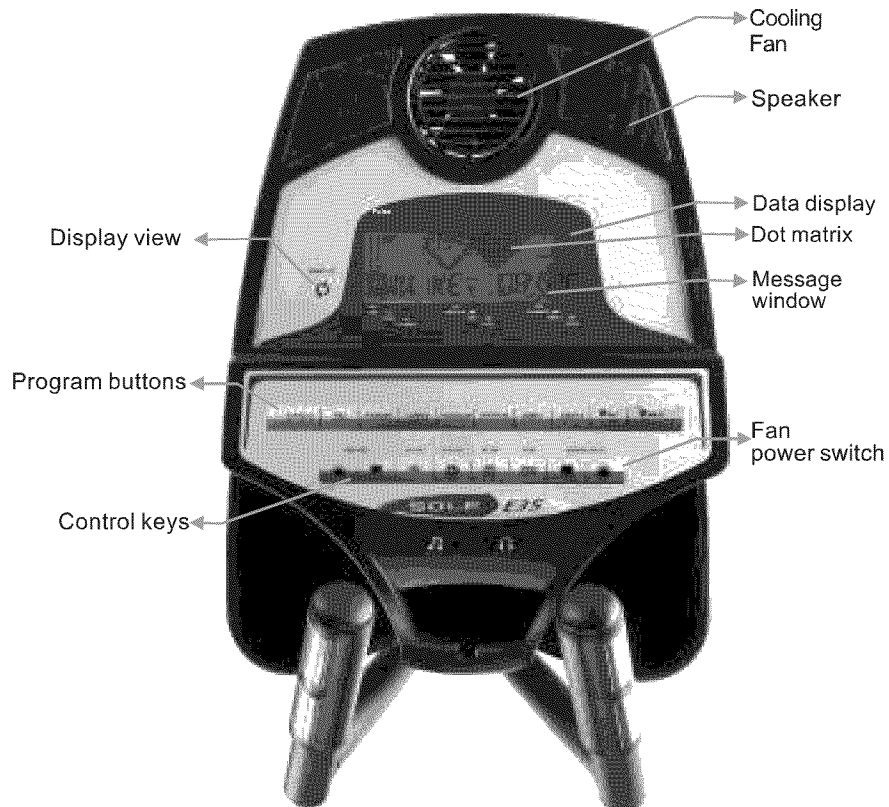

Power up

When power is connected to the Elliptical the console will automatically power up. **The E35** model is connected directly to 115 VAC and there is a power switch located where the line cord plugs into the unit on the left side near the front. **The E25** does not have a power switch. If there is no speed input to the console for 20 minutes the console will go to "Sleep". To turn the console on when it is in sleep mode press any key. When the console is asleep the elliptical draws a tiny amount of electric current; similar to a TV when it is turned off.

When it is first powered on the console will perform an internal self-test. During this time all the lights will turn on. When the lights go off the dot matrix display will show a software version (i.e.: VER 1.0) and the message window will display an odometer reading. The odometer reading displays how many hours the elliptical has been used and how many virtual miles the elliptical has gone. The time in hours will be to the left and the odometer in miles will be displayed to the right.

The odometer will remain displayed for only a few seconds then the console will go to the start up display. The dot matrix display will be scrolling through the different workout profiles and the message window will be scrolling the start up message. You may now begin to use the console.

Console Operation

Quick Start

This is the quickest way to start a workout. After the console powers up you just press the Start key to begin, this will initiate the Quick Start mode. In Quick Start the Time will count up from zero and the workload and incline (E35 only) may be adjusted manually by pressing the Up or Down buttons. The dot matrix display will be showing a track with a blinking dot indicating your progress as it travels around the track.

Basic information

The **Message Window** will initially be displaying the elapsed **Time**, **Program name** and **Distance** (in miles). Each time the **Display button** – located left of the display - is pressed the next set of information will appear. The next set of information displayed will be: **Speed** (in mph), **RPM** (pedaling speed) and **Watts** (indication of work level. A reading of 100 watts means you are doing enough work to light a 100 watt light bulb). The third set of information displayed is: **Calories**, **Level** (work level from 1-20) and **Pulse** (heart rate in beats per minute). Pressing the Display key one more time will set the display the **Incline level (E35 only)** then scan mode where the displayed information will change every 4 seconds.

The Elliptical has a built in **heart rate monitoring system**. Simply grasping the hand pulse sensors on the stationary handle bars or wearing the chest strap transmitter will start the heart icon blinking (this may take a few seconds). The Pulse Display Window will display your heart rate in beats per minute. The chest strap is a more accurate and reliable method of heart rate reading. The hand pulse sensors are subject to false readings depending on user physiology and workout habits including how one grips the sensors or how sweaty their hands are.

The **Stop/Reset** button actually has several functions. Pressing the Stop/Reset key once during a program will **Pause** the program for 5 minutes. If you need to get a drink, answer the phone or any of the many things that could interrupt your workout, this is a great feature. To resume your workout during Pause just press the Start key. If the Stop/Reset button is pressed twice during a workout the program will end and a **Workout Summary** is displayed.

If the Stop/Reset key is held down for 3 seconds the console will perform a complete **Reset**. During data entry for a program the Stop/Reset key performs a **Previous Screen** function. This allows you to go back one step in the programming each time you press the Stop/Reset key.

There is an **Audio Input Jack** on the front of the console and built-in speakers. You may plug any low-level audio source signal into this port. Audio sources include MP3, Ipod, portable radio, CD player or even a TV or computer audio signal. There is also a headphone jack for private listening.

Programming the console

Each of the programs can be customized with your personal information and changed to suit your needs. Some of the information asked for is necessary to ensure the readouts are correct. You will be asked for your **Age** and **Weight**. Entering your **Age** is necessary during the Heart Rate control program to ensure the correct settings are entered in the program; entering your **Weight** aides in calculating a more correct **Calorie** reading. Although we cannot provide an exact calorie count we do want to be as close as possible.

A message about Calories: Calorie readings on every piece of exercise equipment, whether it is in a gym or at home, are not accurate and tend to vary widely. They are meant only as a guide to monitor your progress from workout to workout. The only way to measure your calorie burn accurately is in a clinical setting connected to a host of machines. This is because every person is different and burns calories at a different rate.

Entering a program and changing Settings

Press each program key to scroll through the program selections. The profile for each program will be displayed in the dot matrix window. The E35 model will show the incline profile also when the Display key is pressed. Press the enter key to select a program and begin customizing the settings. If you want to workout without entering new settings then just press the Start key. This will bypass the programming of data and take you directly to the start of your workout. If you want to change the personal settings then just follow the instructions in the message window. If you start a program without changing the settings, the default settings will be used.

NOTE: Age and Weight default settings will change when you enter a new number. So the last Age and Weight entered will be saved as the new default settings. If you enter Age and Weight the first time you use the Elliptical you will not have to enter it every time you work out unless either Age or Weight has changed or someone else enters a different Age and Weight.

Programming: Manual program

The Manual program works as the name implies, manually. This means that you control the workload yourself and not the computer.

1. Press the Manual program button then press the **Enter** key.
2. The message window will ask you to enter your **Weight**. You may adjust the weight setting using the Up and Down keys, then press the Enter key to accept the new number and proceed on to the next screen.
3. You are now asked to enter your **Age**. You may adjust the age setting using the Up and Down keys then press enter to continue.
4. Next is the **Time**. You may adjust the Time and press enter to continue.
5. Now you are finished editing the settings and can begin your workout by pressing the

Start key. You can also go back and modify your settings by pressing the Stop key to go back one level of the programming screen.

6. Once the program starts the elliptical will be set to level one. This is the easiest level and it is a good idea to stay at level one for a while to warm up. If you want to increase the work load at any time press the Up key; the Down key will decrease the workload.
7. During the Manual program you will be able to scroll through the data in the message window by pressing the **Display** key.
8. When the program ends the message window will show a summary of your workout. The summary will be displayed for a short time then the console will return to the start-up display.

Preset Programs

The Elliptical has five different programs that have been designed for a variety of workouts. These five programs have factory preset work level profiles for achieving different goals.

HILL

The **Hill** program simulates going up and down a hill. The resistance in the pedals will steadily increase and then decrease during the program.

Fat Burn

The **Fat Burn** program is designed, as the name implies, to maximize the burning of fat. There are many schools of thought on the best way to burn fat but most experts agree that a lower exertion level that stays at a steady workload is the best. The absolute best way to burn fat is to keep your heart rate at around 60% to 70% of its maximum potential. This program does not use heart rate but simulates a lower, steady exertion workout.

Cardio

The **Cardio** program is designed to increase your Cardio vascular function. This is exercise for your heart and lungs. It will build up your heart muscle and increase blood flow and lung capacity. This is achieved by incorporating a higher level of exertion with slight fluctuations in work.

Strength

The **Strength** program is designed to increase muscular strength in your lower body. This program will steadily increase in resistance to a high level and then keeps you there. This is designed to strengthen and tone your legs and glutes.

Interval

The **Interval** program takes you through high levels of intensity followed by periods of low intensity. This program increases your endurance by depleting your oxygen level followed by periods of recovery to replenish oxygen. Your cardio vascular system gets programmed to use oxygen more efficiently this way.

Programming Preset Programs:

1. Press the desired program button then press the enter key.
2. The message window will ask you to enter your **Weight**. You may adjust the weight setting, using the Up and Down keys, then press the Enter key to accept the new number and proceed on to the next screen.
3. You are now asked to enter your **Age**. You may adjust the age number using the Up and Down keys then press enter to continue.
4. Next is **Time**. You may adjust the Time and press enter to continue.
5. Now you are asked to adjust the **Max Level**. This is the peak exertion level you will experience during the program (at the top of the hill). Adjust the level and then press enter.
6. ***For E35 only:** You can now choose to turn off the incline profile for this program. If you

choose to turn off incline, you can still control the incline manually during your workout, but the automated incline changes will be off. Press the enter key when you are finished selecting.

7. Now you are finished editing the settings and can begin your workout by pressing the Start key. You can also go back and modify your settings by pressing the Stop key to go back one level, or screen.
8. If you want to increase or decrease the workload or incline (E35 only) at any time during the program press the Up or Down keys.
9. During the program you will be able to scroll through the data in the message window by pressing the **Display** key.
10. When the program ends the message window will show a summary of your workout. The summary will be displayed for a short time then the console will return to the start-up display.

Custom User Defined Programs

The customizable **User** programs allow you to build and save your own workout. You can build your own custom program by following the instructions below.

1. Select the **User** program (U1 or U2) then press enter.
2. The message window will ask you to enter your **Weight**. You may enter your weight using the Up and Down keys, then press the Enter key to accept the new number and proceed on to the next screen.
3. You are now asked to enter your **Age**. You may adjust the age number using the Up and Down keys, then press enter to continue.
4. Next is **Time**. You may adjust the Time and press enter to continue.
5. Now the first column will be blinking and you are asked to adjust the level for the first segment of the workout. When you finish adjusting the first segment, or if you don't want to change, then press enter to continue to the next segment.
6. The next segment will show the same level as the previously adjusted segment. Repeat the same process as the last segment then press enter. Continue this process until all twenty segments have been set.
7. **E35 only:** Now the first column will be blinking again and you are asked to adjust the Incline level for the first segment of the workout. Follow the same procedure for building the Incline profile as you did for the resistance profile.
8. The message window will then tell you to start to begin (and save the program) or enter to modify the program. Pressing Stop will exit to the start up screen.
9. If you want to increase or decrease the workload at any time during the program press the Up or Down key. This will only affect the workload for the present position in the profile. When the profile changes to the next column it will return to the preset work level.
10. During the User 1 or User 2 program you will be able to scroll through the data in the message window by pressing the **Display** key.
11. When the program ends the message window will show a summary of your workout. The summary will be displayed for a short time then the console will return to the start-up display.

Heart Rate programs

Before we get started, a word about Heart Rate:

The old motto, “no pain, no gain”, is a myth that has been overpowered by the benefits of exercising comfortably. A great deal of this success has been promoted by the use of heart rate monitors. With the proper use of a heart rate monitor, many people find that their usual choice of exercise intensity was either too high or too low and exercise is much more enjoyable by maintaining their heart rate in the desired benefit range.

To determine the benefit range in which you wish to train, you must first determine your Maximum Heart Rate. This can be accomplished by using the following formula: 220 minus your age. This will give you the Maximum heart rate (MHR) for someone of your age. To determine the effective heart rate range for specific goals you simply calculate a percentage your MHR. Your Heart rate training zone is 50% to 90% of your maximum heart rate. 60% of your MHR is the zone that burns fat while 80% is for strengthening the cardio vascular system. This 60% to 80% is the zone to stay in for maximum benefit.

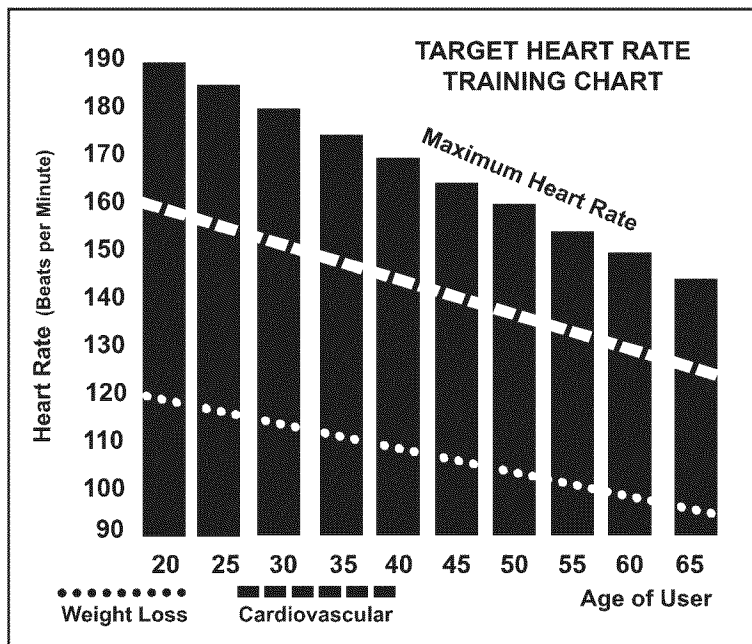

For someone who is 40 years old their target heart rate zone is calculated:

$$\begin{aligned} 220 - 40 &= 180 \text{ (maximum heart rate)} \\ 180 \times .6 &= 108 \text{ beats per minute (60\% of maximum)} \\ 180 \times .8 &= 144 \text{ beats per minute (80\% of maximum)} \end{aligned}$$

So for a 40 year old the training zone would be 108 to 144 beats per minute.

If you enter your age during programming the console will perform this calculation automatically. Entering your age is used for the Heart Rate control programs. After calculating your Maximum Heart Rate you can decide upon which goal you would like to pursue.

The two most popular reasons for, or goals, of exercise are cardiovascular fitness (training for the heart and lungs) and weight control. The black columns on the chart above represent the Maximum Heart Rate for a person whose age is listed at the bottom of each column. The training heart rate, for either cardiovascular fitness or weight loss, is represented by two different lines that cut diagonally through the chart. A definition of the lines' goal is in the bottom left-hand corner of the chart. If your goal is cardiovascular fitness or if it is weight loss, it can be achieved by training at 80% or 60%, respectively, of your Maximum Heart Rate on a schedule approved by your physician. Consult your physician before participating in any exercise program.

With all SOLE Heart Rate Control elliptical machines you may use the heart rate monitor feature without using the Heart Rate Control program. This function can be used during manual mode or during any of the nine different programs. The Heart Rate Control program automatically controls resistance at the pedals.

Rate of Perceived Exertion

Heart rate is important but listening to your body also has a lot of advantages. There are more variables involved in how hard you should workout than just heart rate. Your stress level, physical health, emotional health, temperature, humidity, the time of day, the last time you ate and what you ate, all contribute to the intensity at which you should workout. If you listen to your body, it will tell you all of these things.

The rate of perceived exertion (RPE), also know as the Borg scale, was developed by Swedish physiologist G.A.V. Borg. This scale rates exercise intensity from 6 to 20 depending upon how you feel or the perception of your effort.

The scale is as follows:

Rating Perception of Effort

- 6 Minimal
- 7 Very,very light
- 8 Very,very light +
- 9 Very light
- 10 Very light +
- 11 Fairly light
- 12 Comfortable
- 13 Somewhat hard
- 14 Somewhat hard +
- 15 Hard
- 16 Hard +
- 17 Very hard
- 18 Very hard +
- 19 Very,very hard
- 20 Maximal

You can get an approximate heart rate level for each rating by simply adding a zero to each rating. For example a rating of 12 will result in an approximate heart rate of 120 beats per minute. Your RPE will vary depending up the factors discussed earlier. That is the major benefit of this type of training. If your body is strong and rested, you will feel strong and your pace will feel easier. When your body is in this condition, you are able to train harder and the RPE will support this. If you are feeling tired and sluggish, it is because your body needs a break. In this condition, your pace will feel harder. Again, this will show up in your RPE and you will train at the proper level for that day.

Using a Heart Rate Transmitter

How to wear your wireless chest strap transmitter:

1. Attach the transmitter to the elastic strap using the locking parts.
2. Adjust the strap as tightly as possible as long as the strap is not too tight to remain comfortable.
3. Position the transmitter with the SOLE logo centered in the middle of your body facing away from your chest (some people must position the transmitter slightly left of center). Attach the final end of the elastic strap by inserting the round end and, using the locking parts, secure the transmitter and strap around your chest.
4. Position the transmitter immediately below the pectoral muscles.
5. Sweat is the best conductor to measure very minute heart beat electrical signals. However, plain water can also be used to pre-wet the electrodes (2 black square areas on the reverse side of the belt and either side of transmitter). It's also recommended that you wear the transmitter strap a few minutes before your work out. Some users, because of body chemistry, have a more difficult time in achieving a strong, steady signal at the beginning. After "warming up", this problem lessens. As noted, wearing clothing over the transmitter/strap doesn't affect performance.
6. Your workout must be within range - distance between transmitter/receiver – to achieve a strong steady signal. The length of range may vary somewhat but generally stay close enough to the console to maintain good, strong, reliable readings. Wearing the transmitter immediately against bare skin assures you of proper operation. If you wish, you may wear the transmitter over a shirt. To do so, moisten the areas of the shirt that the electrodes will rest upon.

Note: The transmitter is automatically activated when it detects activity from the user's heart. Additionally, it automatically deactivates when it does not receive any activity. Although the transmitter is water resistant, moisture can have the effect of creating false signals, so you should take precautions to completely dry the transmitter after use to prolong battery life (estimated transmitter battery life is 2500 hours). The replacement battery is Panasonic CR2032.

Erratic Operation:

Caution! Do not use this elliptical for Heart Rate Control unless a steady, solid Actual Heart Rate value is being displayed. High, wild, random numbers being displayed indicate a problem.

Areas to look for interference which may cause erratic heart rate:

- (1) Microwave ovens, TV's, small appliances, etc.
- (2) Fluorescent lights.
- (3) Some household security systems.
- (4) Perimeter fence for a pet.
- (5) Some people have problems with the transmitter picking up a signal from their skin. If you have problems try wearing the transmitter upside down. Normally the transmitter will be oriented so the SOLE logo is right side up.
- (6) The antenna that picks up your heart rate is very sensitive. If there is an outside noise source, turning the whole machine 90 degrees may de-tune the interference.
- (7) Loose treadmill console or bolts in the upright tube could also cause intermittent problems.
- (8) If you continue to experience problems contact your dealer.

Heart Rate Control Program operation

To start the **HRC** program follow the instructions below or just select the HRC program then the Enter button and follow the directions in the message window.

1. Select the **HRC** program then press the **Enter** key.
2. The message window will ask you to enter your **Weight**. You may enter your weight using the Up and Down keys or the numeric key pad, then press the Enter key to accept the new number and proceed on to the next screen.
3. You are now asked to enter your **Age**. You may adjust the age number using the Up and Down keys or the numeric key pad, then press enter to continue.
4. Next is **Time**. You may adjust the Time and press enter to continue.
5. Now you are asked to adjust the **HRC** percent. The default is 70%; you may select 60% or 80% also. Adjust the level and then press enter.
6. You are now asked to select the Target heart rate Level. This is the heart rate level you will experience during the program. Adjust the level and then press enter.
7. Now you are finished editing the settings and can begin your workout by pressing the Start key. You can also go back and modify your settings by pressing the Stop key to go back one level, or screen.
8. If you want to increase or decrease the workload at any time during the program press the Up or Down key. This will allow you to change your target heart rate at any time during the program.
9. During the HRC program you will be able to scroll through the data in the message window by pressing the **Display** key.

When the program ends the message window will show a summary of your workout. The summary will be displayed for a short time then the console will return to the start-up display

Maintenance:

1. Wipe down all areas in the sweat path with a damp cloth after each workout.
2. If a squeak, thump, clicking or rough feeling develops the main cause is most likely one of two reasons:
 - i. The hardware was not sufficiently tightened during assembly. All bolts that were installed during assembly need to be tightened as much as possible. It may be necessary to use a larger wrench than the one provided if you cannot tighten the bolts sufficiently. I cannot stress this point enough; 90% of calls to the service department for noise issues can be traced to loose hardware or the rear rails being dirty.
 - ii. Dirt build-up on the rear rails and polyurethane wheels are also a source of noise. Noise from build-up on the rails can cause a thumping sound that you would swear is coming from inside the main body of the machine because noise travels, and is amplified in the tubing of the frame. Clean the rails and wheels with a lint free cloth and rubbing alcohol. Stubborn build-up can be removed with your thumbnail or a non-metallic scraper, like the back edge of a plastic knife. After cleaning, apply a small amount of lubricant on the rails with your fingers or a lint free cloth. You only need a thin coat of lubrication, wipe off any excess.
3. If squeaks or other noises persist, check that the unit is properly leveled before calling the service department.

Maintenance Menu in console software:

The console has built in maintenance/diagnostic software. The software will allow you to change the console settings from English to Metric and turn off the beeping of the speaker when a key is pressed for example. To enter the Maintenance menu (may be called Engineering mode, depending on version) press and hold down the Start, Stop and Enter keys. Keep holding the keys down for about 5 seconds and the message window will display "Engineering mode". Press the enter button to access the menu below. Press the up and down keys to navigate the menu.

- a. **Key test** (will allow you to test all the keys to make sure they are functioning)
- b. **Functions** (Press enter to access settings, use up/dn keys to scroll)
 - i. **ODO reset** (reset the odometer)
 - ii. **Units** (Set to English or Metric display readings)
 - iii. **Sleep mode** (Turn on to have the console power down automatically after 20 minutes of inactivity)
 - iv. **Motor test** (continually runs the tensioning gear motor)
 - v. **Manual** (Allows stepping of the gear motor)
 - vi. **Key tone** (Turn on or off the beep when a key is pressed)
 - vii. **Calibration** Allows you to calibrate the gear motor that sets the workload. Press enter to calibrate and the motor will reset itself to make sure that level 1 is set to the lowest resistance possible.
- c. **Security** (Allows you to lock the keypad so no unauthorized use is allowed) When the child lock is enabled, the console will not allow the keypad to operate unless you press and hold the Start and Enter buttons for 3 seconds to unlock the console.
- d. **Exit** Select to exit engineering mode

Incline calibration: If there is a problem with the incline, try running the calibration. Press the **Incline up** key and the **Start** key at the same time. Hold them down for 5 seconds and the Incline calibration will start and run automatically. If the problem persists contact service.

Manufacturer's Limited Warranty

Effective January 1, 2008 ELLIPTICAL WARRANTY

SOLE warrants all its elliptical parts for a period of time listed below from the date of retail sale, as determined by sale receipt, or in the absence of a sales receipt eighteen (18) months from the original factory shipping date. SOLE's responsibilities include providing new or remanufactured parts, at SOLE's option, and technical support to our independent dealers and servicing organizations. In the absence of a dealer or service organization, these warranties will be administered by SOLE directly to a consumer. The warranty period applies to the following components:

| E25 | | E35 | |
|----------------------|----------|----------------------|----------|
| Labor | 1 year | Labor | 2 years |
| Frame Weldments | Lifetime | Frame Weldments | Lifetime |
| Brake | Lifetime | Brake | Lifetime |
| All Other Components | 3 years | All other Components | 5 years |

NORMAL RESPONSIBILITIES OF THE CONSUMER

This warranty applies only to products in ordinary household use, and the consumer is responsible for the items listed below:

1. The warranty registration card must be completed and returned to the address listed on the card within 10 days of the original purchase to validate the manufacturer's limited warranty.
2. Proper use of the elliptical in accordance with the instructions provided in this manual
3. Proper installation in accordance with instructions provided with the elliptical and with all local electric codes.
4. Proper connection to a grounded power supply of sufficient voltage, replacement of blown fuses, repair of loose connections or defects in house wiring.
5. Expenses for making the elliptical accessible for servicing, including any item that was not part of the elliptical at the time it was shipped from the factory.
6. Damages to the elliptical finish during shipping, installation or following installation.

EXCLUSIONS

This warranty does not cover the following:

1. CONSEQUENTIAL, COLLATERAL, OR INCIDENTAL DAMAGES SUCH AS PROPERTY DAMAGE AND INCIDENTAL EXPENSES RESULTING FROM ANY BREACH OF THIS WRITTEN OR ANY IMPLIED WARRANTY.

Note: Some states do not allow the exclusion or limitation of incidental or consequential damages, so this limitation or exclusion may not apply to you.

2. Service call reimbursement to the consumer. Service call reimbursement to the dealer that does not involve malfunction or defects in workmanship or material, for units that are beyond the warranty period, for units that are beyond the service call reimbursement period, for elliptical not requiring component replacement, or elliptical not in ordinary household use.
3. Damages caused by services performed by persons other than authorized SOLE service companies; use of parts other than original SOLE parts; or external causes such as alterations, modifications, abuse, misuse, accident, improper maintenance, inadequate power supply, or acts of God.
4. Products with original serial numbers that have been removed or altered.
5. Products that have been: sold, transferred, bartered, or given to a third party.
6. Products that do not have a warranty registration card on file at SOLE. SOLE reserves the right to request proof of purchase if no warranty record exists for the product.
7. THIS WARRANTY IS EXPRESSLY IN LIEU OF ALL OTHER WARRANTIES EXPRESSED OR IMPLIED, INCLUDING THE WARRANTIES OF MERCHANTABILITY AND/OR FITNESS FOR A PARTICULAR PURPOSE.

SERVICE

Keep your bill of sale. Twelve (12) months from the date on the bill of sale or eighteen (18) months from the date of factory shipping as determined by the serial number establishes the labor warranty period should service be required. If service is performed, it is in your best interest to obtain and keep all receipts. This written warranty gives you specific legal rights. You may also have other rights that vary from state to state. Service under this warranty must be obtained by following these steps, in order:

1. Contact your selling authorized SOLE dealer. OR
2. Submit all service requests including serial number, contact information and a brief description of the problem online at www.soletreadmills.com/technical.php?p=service.
3. If you have any questions about your new product or questions about the warranty contact SOLE Fitness at 1-866-780-SOLE (7653). If you have a technical problem with your new elliptical contact SOLE technical service at 866-MYSOLE1 (697-6531).
4. If no local service is available, SOLE will repair or replace the parts, at SOLE's option, within the warranty period at no charge for parts. All transportation costs, both to our factory and upon return to the owner, are the responsibility of the owner. The owner is responsible for adequate packaging upon return to SOLE. SOLE is not responsible for damages in shipping. Make all freight damage claims with the appropriate freight carrier. DO NOT SHIP ANY UNIT TO OUR FACTORY WITHOUT A RETURN AUTHORIZATION NUMBER. All units arriving without a return authorization number will be refused.
5. For any further information, or to contact our service department by mail, send your correspondence to:

**SOLE Fitness
P.O. Box 2037
Jonesboro, AR 72402-2037**

Product features or specifications as described or illustrated are subject to change without notice. All warranties are made by SOLE.