

Nikon

培養倒立顕微鏡

ECLIPSE

TS100/TS100-F

TS100LED MV/TS100LED-F MV

使用説明書

Inverted Microscope

ECLIPSE

TS100/TS100-F

TS100LED MV/TS100LED-F MV

Instructions

Introduction

Thank you for purchasing a Nikon product.

This instruction manual is written for users of the Nikon Inverted Microscope ECLIPSE TS100/TS100-F/TS100LED MV/TS100LED-F MV.

To ensure correct usage, read this manual carefully before operating the product.

- No part of this manual may be reproduced or transmitted in any form without prior written permission from Nikon.
- The contents of this manual are subject to change without notice.
- The equipment described in this manual may differ from the actual product in its appearance.
- Although every effort has been made to ensure the accuracy of this manual, errors or inconsistencies may remain. If you note any points that are unclear or incorrect, please contact your nearest Nikon representative.
- Some of the equipment described in this manual may not be included in the set you have purchased.
- If you intend to use any other equipment with this product, read the manual for that equipment too.
- If the equipment is used in a manner not specified by the manufacturer, the protection provided by the equipment may be impaired.

Training

You can use this product without the need of special training sessions by reading this manual thoroughly before use. Please contact your nearest Nikon representative if you have any questions or find any errors and anything you are aware of.

Contents

Introduction	E-1
Safety Precautions	E-3
WARNING and CAUTION Symbols Used in This Manual	E-3
Meaning of Symbols Used on the Product	E-3
⚠ WARNING and ⚠ CAUTION for Using the TS100/TS100-F	E-4
⚠ WARNING and ⚠ CAUTION for Using the TS100LED MV/TS100LED-F MV	E-8
Notes on Handling the Product	E-10
1 Names of Parts	E-12
2 Names of Operational Parts	E-13
3 Microscopy	E-14
1 Microscopy	E-14
1-1 Phase Contrast Microscopy	E-17
1-2 Modulation Contrast (NAMC) Microscopy	E-19
1-3 Bright-field Microscopy	E-22
4 Operation of Each Part	E-23
1 Aperture Diaphragm	E-23
2 Specimen and Stage	E-24
3 Focusing Device	E-25
4 Filters	E-26
5 Objectives	E-26
6 Modulation Contrast Method	E-29
7 Photomicrography (for TS100-F/TS100LED-F MV only)	E-31
5 Assembly	E-33
1 Assembling the Basic Set	E-33
2 Assembling Components Not Included in the Basic Set	E-36
6 Troubleshooting	E-38
1 Optical	E-38
2 Operational	E-42
3 Electrical	E-44
7 Care and Maintenance	E-46
1 Cleaning the Lenses	E-46
2 Cleaning the Microscope	E-46
3 Disinfecting the Microscope	E-46
4 Storing the Microscope	E-46
5 Regular Inspection (Charged)	E-46
8 Specifications	E-47
1 Microscopy (Principles)	E-47
2 Performance Properties	E-47
3 Physical Properties	E-50



Safety Precautions

To ensure correct and safe operation, read this manual before using the product.

WARNING and CAUTION Symbols Used in This Manual

Although this product is designed and manufactured to be completely safe during use, incorrect usage or failure to follow the safety instructions provided may cause personal injury or property damage. To ensure correct usage, read this manual carefully before using the product. Do not discard this manual and keep it handy for easy reference.



Safety instructions in this manual are marked with the following symbols to highlight their importance. For your safety, always follow the instructions marked with these symbols.

Symbol	Description
 WARNING	Disregarding instructions marked with this symbol may lead to serious injury or death.
 CAUTION	Disregarding instructions marked with this symbol may lead to injury or property damage.

Meaning of Symbols Used on the Product

The symbol appearing on the product indicates the need for caution at all times during use.

Always refer to the instruction manual and read the relevant instructions before manipulating any part to which the symbol has been affixed.

Symbol	Description				
	<p>CAUTION! Biohazard</p> <p>This symbol label attached on the stages reminds you of the following:</p> <ul style="list-style-type: none"> • WARNING: Spillage of a sample from a vessel onto the microscope, presents a biohazard risk. • To avoid biohazard contamination, do not touch the contaminated portion with your bare hands. • Decontaminate the contaminated portion according to the standard procedure of your laboratory. 				
	<p>CAUTION for heat (for TS100/TS100-F only)</p> <p>This symbol label attached on the lamphouse cover reminds you of the following:</p> <ul style="list-style-type: none"> • Lamp and its surrounding areas (including the lamphouse cover) become very hot during and immediately after illumination. • Risk of burns. Do not touch the lamp and its surrounding areas during and immediately after illumination. • When replacing the lamp, wait approximately 30 minutes after turning off the lamp, and make sure that the lamp and its surrounding areas have cooled sufficiently before working. 				
	<p>CAUTION (for TS100/TS100-F only)</p> <p>This symbol label attached near the AC inlet reminds you of the following:</p> <ul style="list-style-type: none"> • Check the input voltage before turning on the microscope. (The input voltage is given on the "nameplate" and on immediate right of the AC inlet.) • The voltage selector on the microscope sent to the United States is set to "120V" at the factory. • If the input voltage shown differs from the local voltage level, do not turn on the microscope. <p>Do the following instead:</p> <table border="0"> <tr> <td>Different voltage on the nameplate:</td> <td>Contact your nearest Nikon representative.</td> </tr> <tr> <td>Different voltage on right of the AC inlet:</td> <td>Change the input voltage setting; refer to P.33.</td> </tr> </table>	Different voltage on the nameplate:	Contact your nearest Nikon representative.	Different voltage on right of the AC inlet:	Change the input voltage setting; refer to P.33.
Different voltage on the nameplate:	Contact your nearest Nikon representative.				
Different voltage on right of the AC inlet:	Change the input voltage setting; refer to P.33.				

⚠️ WARNING and ⚠️ CAUTION for Using the TS100/TS100-F



WARNING

1. Do not disassemble.

Disassembly may cause malfunction and/or electrical shock, and will lead to the forfeiture of all claims against warranty. Do not disassemble any part other than those described in this manual. If you experience any problem with the microscope, contact your nearest Nikon representative.

2. Read the instructions thoroughly.

To ensure safety, thoroughly read this manual and the manuals for other equipment to be used with this product. In particular, be sure to follow the warnings and cautions at the beginning of the manuals.

3. Input voltage

Make sure that the input voltage indicated on two places (on the nameplate and on the immediate right of the AC inlet at the microscope's rear) are the same as your local voltage. Do not use the microscope if the local voltage differs from that required by the microscope. Follow the instructions below if this is the case. Use of the microscope under the incorrect voltage may cause over-heating due to over-current, possibly resulting in a fire and damaging the microscope.

- If the voltage indicated on the nameplate differs from local voltage, do not turn on the power but contact your nearest Nikon representative immediately.
- If the voltage indicated to the immediate right of the AC inlet differs from local voltage, change the input voltage setting as described on P.33 before turning on the power. The following values may be set for the input voltage.
 - If the nameplate reads "100/110/120 V ~", the input voltage may be set to 100, 110 or 120 V AC. (Factory setting: 120 V AC)
 - If the nameplate reads "220/230/240 V ~", the input voltage may be set to 220, 230 or 240 V AC. (Factory setting: 240 V AC)

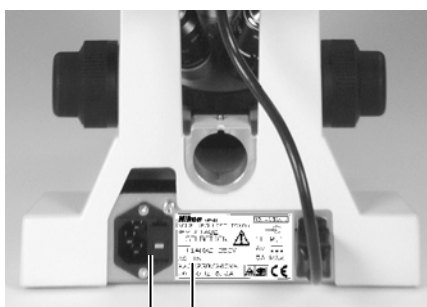

Input voltage indications

4. Use only the specified lamp and fuse.

Use only the specified lamp and fuse. Use of other lamp and fuse may result in damage to the microscope or fire.

- Specified lamp: Halogen lamp 6 V-30 W (PHILIPS 5761)
- Specified fuse: 250V, 1A, time-lag, low-breaking type 5x20 miniature fuse x2

**WARNING****5. Cautions on lamp replacement**

- When replacing the lamp, wait approximately 30 minutes after turning off the lamp, and make sure that the lamp and its surrounding areas have cooled sufficiently before working.
- To prevent electric shock and product damage, turn off the power of the microscope (press the power switch to the "○" position) and unplug the power cord from the wall outlet before replacing the lamp.
- When replacing the lamp, be sure that the lamp socket is not damaged. If it is damaged, it may cause lamp failure or overheating. In addition, install the lamp into the lamp socket until it hits the limit. If the lamp is not properly installed, it may fall off or cause overheating or smoke due to mal-connection.
- After replacing the lamp, be sure to attach the lamphouse cover. Never use the product without the lamphouse cover attached.
- Do not break the used lamp. It should be disposed of as an industrial waste, according to the local regulations and rules.

6. Cautions on the power cord

- If the nameplate reads "100/110/120 V ~":
Be sure to use the provided power cord. Use of other power cords may result in malfunction or fire.
Do not use the provided power cord for other purpose.
See Chapter 8, "Specifications - 2 Performance Properties" for the provided power cord.
- If the nameplate reads "220/230/240 V ~":
Be sure to use the specified power cord. Use of other power cords may result in malfunction or fire.
See Chapter 8, "Specifications - 2 Performance Properties" for the specified power cord.

7. Heat from the light source

Do not touch the lamphouse while the lamp is on and for about 30 minutes after it is turned off as it becomes extremely hot.

- Allow the lamp to cool sufficiently (for at least 30 minutes after being turned off) before replacing the lamp.
- To avoid burns, never touch the lamp and its surrounding areas while the lamp is on and for about 30 minutes after the lamp has been turned off.
- To avoid the risk of fire, do not allow cloth, paper, or highly flammable volatile materials, such as gasoline, petroleum benzine, acetone, thinner or alcohol, to come near the lamp and its surrounding areas while the lamp is on and for about 30 minutes after the lamp has been turned off.



WARNING

8. Notes on handling flammable solvents

The following flammable solvents are used with the product:

- Immersion oil (Nikon immersion oil for oil immersion objectives)
- Absolute alcohol (ethyl alcohol or methyl alcohol for cleaning optical parts)
- Petroleum benzine (for wiping off the immersion oil)
- Medical alcohol (for disinfecting the microscope)

Never hold a flame near these solvents. When using a solvent, thoroughly read the instructions provided by the manufacturer, and handle correctly and safely. Note the following precautions when using solvents with the product.

- Keep solvents away from the lamp, lamphouse cover and any other parts that may become hot.
- Keep solvents away from the product and its surroundings when turning on/off the power switch or plugging/unplugging the power cord.
- Be careful not to spill the solvents.

9. Hazardous sample

This microscope should mainly be used for microscopic observation and micromanipulation of living cells and tissue cultures in Petri dishes, microtiter plates, etc.

When handling a sample, check to determine whether the sample is hazardous.

Handle hazardous samples according to the standard procedure of your laboratory. If the sample is of an infectious nature, wear rubber gloves to avoid infection, and be careful not to spill the sample. In the event of spillage of a sample from a vessel onto the microscope, decontaminate the contaminated portion according to the standard procedure of your laboratory.

**CAUTION****1. Turn off the power when assembling the microscope, replacing lamps and fuses, and plugging or unplugging the power cord.**

To prevent electrical shock and/or fire, always turn off the power of the microscope (press the power switch to the "○" position) before plugging or unplugging the power cord. Also, always turn off the power of the microscope (press the power switch to the "○" position) and unplug the power cord when assembling the microscope, or replacing lamps or fuses.

2. Do not wet the microscope or allow foreign matter to get inside.

If the microscope becomes wet, a short circuit may result that may damage it or make it extremely hot. Similarly, a short may occur if foreign matter gets inside. If you accidentally spill a liquid on the microscope, immediately turn off the power of the microscope (press the power switch to the "○" position) and unplug the power cord. (Take care not to touch the cord with wet hands at this time.) After unplugging the microscope, use a dry cloth to wipe away any moisture.

If liquid spills on the water tray, use tissue paper to absorb it from the groove on the left. Then remove the water tray cover using a hexagonal wrench. Wipe dry the inside if there is any moisture. Check if the lamp cable connector or AC inlet on the rear panel are wet, and if so, wipe them dry.

If any liquid or foreign matter gets inside, do not use the microscope, but contact your nearest Nikon representative.

3. Cautions on carrying the microscope

- Securely hold the microscope at the bottom front and back when transporting it.
- Do not grasp the focus knobs, eyepiece tube, stage, etc. when carrying the microscope. This may cause the part to come off, resulting in damage to the microscope.

4. Cautions on assembling the product

- Take care to avoid pinching your fingers and hands.
- Scratches and dirt (i.e. fingerprints) on optical components such as lenses and filters will degrade the microscope image. When assembling the product, be careful not to scratch or directly touch the optical components.

5. Disposal of the microscope

To avoid biohazard risk, dispose of the microscope as the contaminated equipment according to the standard procedure of your laboratory.

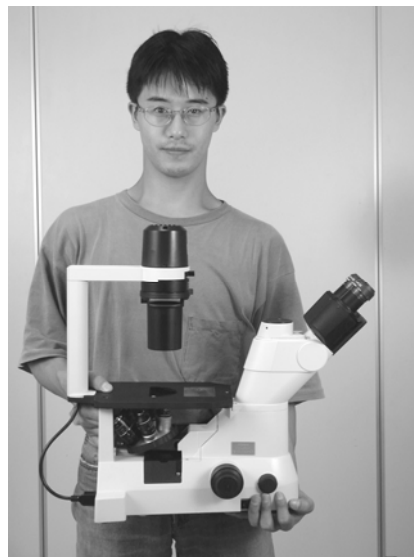

WARNING and **CAUTION** for Using the TS100LED MV/TS100LED-F MV



WARNING

1. Do not disassemble.

Disassembly may cause malfunction and/or electrical shock, and will lead to the forfeiture of all claims against warranty. Do not disassemble any part other than those described in this manual. If you experience any problem with the microscope, contact your nearest Nikon representative.

2. Read the instructions thoroughly.

To ensure safety, thoroughly read this manual and the manuals for other equipment to be used with this product. In particular, be sure to follow the warnings and cautions at the beginning of the manuals.

3. Input voltage

This product can be used with 100 to 240 V AC at 50/60 Hz, and can be used with most wall outlets in the world. However, note that you avoid using the product under an environment where the supply voltage may extremely fluctuate.

4. Cautions on the power cord

Be sure to use the provided (or specified) power cord. Use of other power cords may result in malfunction or fire.

- See Chapter 8, "Specifications - 2 Performance Properties" for the specified power cord.
- To prevent electric shock, turn off the power switch (press the power switch to the "○" position) before connecting or disconnecting the power cord.
- Note that this product is classified as Class I for electric shock protection. Be sure to connect it to a protective earth terminal.

5. Notes on handling flammable solvents

The following flammable solvents are used with the product:

- Immersion oil (Nikon immersion oil for oil immersion objectives)
- Absolute alcohol (ethyl alcohol or methyl alcohol for cleaning optical parts)
- Petroleum benzine (for wiping off the immersion oil)
- Medical alcohol (for disinfecting the microscope)

Never hold a flame near these solvents. When using a solvent, thoroughly read the instructions provided by the manufacturer, and handle correctly and safely. Note the following precautions when using solvents with the product.

- Keep solvents away from any parts that may become hot.
- Keep solvents away from the product and its surroundings when turning on/off the power switch or plugging/unplugging the power cord.
- Be careful not to spill the solvents.

**WARNING****6. Hazardous sample**

This microscope should mainly be used for microscopic observation and micromanipulation of living cells and tissue cultures in Petri dishes, microtiter plates, etc.

When handling a sample, check to determine whether the sample is hazardous.

Handle hazardous samples according to the standard procedure of your laboratory. If the sample is of an infectious nature, wear rubber gloves to avoid infection, and be careful not to spill the sample. In the event of spillage of a sample from a vessel onto the microscope, decontaminate the contaminated portion according to the standard procedure of your laboratory.

**CAUTION****1. Turn off the power when assembling the microscope and plugging or unplugging the power cord.**

To prevent electrical shock and/or fire, always turn off the power of the microscope (press the power switch to the "○" position) before plugging or unplugging the power cord. Also, always turn off the power of the microscope (press the power switch to the "○" position) and unplug the power cord when assembling the microscope.

2. Do not wet the microscope or allow foreign matter to get inside.

If the microscope becomes wet, a short circuit may result that may damage it or make it extremely hot. Similarly, a short may occur if foreign matter gets inside. If you accidentally spill a liquid on the microscope, immediately turn off the power of the microscope (press the power switch to the "○" position) and unplug the power cord. (Take care not to touch the cord with wet hands at this time.) After unplugging the microscope, use a dry cloth to wipe away any moisture.

If liquid spills on the water tray, use tissue paper to absorb it from the groove on the left. Then remove the water tray cover using a hexagonal wrench. Wipe dry the inside if there is any moisture. Check if the lamp cable connector or AC inlet on the rear panel are wet, and if so, wipe them dry.

If any liquid or foreign matter gets inside, do not use the microscope, but contact your nearest Nikon representative.

3. Cautions on carrying the microscope

- Securely hold the microscope at the bottom front and back when transporting it.
- Do not grasp the focus knobs, eyepiece tube, stage, etc. when carrying the microscope. This may cause the part to come off, resulting in damage to the microscope.

4. Cautions on assembling the product

- Take care to avoid pinching your fingers and hands.
- Scratches and dirt (i.e. fingerprints) on optical components such as lenses and filters will degrade the microscope image. When assembling the product, be careful not to scratch or directly touch the optical components.

5. Disposal of the microscope

To avoid biohazard risk, dispose of the microscope as the contaminated equipment according to the standard procedure of your laboratory.

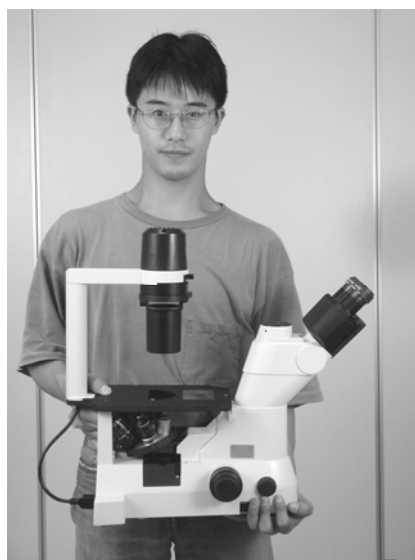

Notes on Handling the Product

1. Handle with care.

The microscope is a precision optical instrument. Handle it carefully and do not subject it to strong physical shocks and vibrations. The accuracy of the objective in particular may be adversely affected by even a weak physical shock.

2. Weak electromagnetic waves

This product emits weak electromagnetic waves. So as to avoid degrading the performance of precision electronic devices, do not install this product near such devices. If TV or radio reception is affected, move the TV or radio further from this product.

3. Installation location and storage location

The product is a precision optical instrument. Use or storage of the product under inappropriate conditions may result in malfunctions or loss of precision. The following conditions must be considered for the installation location and the storage location.

- Install the product in a location with a temperature of 0 to +40°C and a relative humidity of 60% or less (no condensation).
Store the product in a location with a temperature of -20 to +60°C and a relative humidity of 90% or less (no condensation).
Use or storage of the product in a hot or humid location may result in molding of or condensation on the lenses, loss of precision, and malfunctions.
- Install the product in a place with little dust and dirt.
When storing the product, place a cover over the product to protect it from dust.
- Install the product in a place with little vibration.
- Install and store the product on a level and sturdy table or stage that can bear the weight of the product.
Install the product in a location with minimal exposure to hazards in the event of earthquakes and other potential disasters. If necessary, secure the product to the working desk or other heavy and stable items with a strong rope or other means, so as to prevent it from falling.
- Install the product so that the power cord to the microscope can be unplugged immediately from the AC inlet in case of an emergency.
- Avoid placing the product in direct sunlight or immediately under the room lights.
The image quality is degraded in a bright environment due to the extraneous light entering the objective. A room light immediately above the microscope may also enter the objective as extraneous light, especially when using a condenser lens with a longer working distance. In this case, it is recommended that you turn off the room light above the microscope.
- Install the product at least 10 cm away from the surrounding walls.
- Do not install the product in a closed space such as a locker or a cabinet.
- Do not place items on the product.

4. Notes on handling lamps (for TS100/TS100-F only)

- Do not touch the lamp glass with bare hands. This may soil the glass surface, degrade performance, damage the lamp, and/or reduce the life expectancy of the lamp. Wear gloves or use a piece of cloth when handling lamps. If the glass surface becomes dirty, wipe with clean cloth lightly moistened with alcohol.
- Do not subject the lamp to shocks or vibrations as this may damage the lamp or shorten its life expectancy.

5. Notes on handling optical parts

Scratches and dirt (i.e. fingerprints) on optical components such as lenses and filters will degrade the microscope image.

Handle the optical components with care, so as not to damage them. If they require cleaning, refer to Chapter 7, "Care and Maintenance".

6. Focus knobs

Do not rotate the right and left knobs in opposite directions at the same time. Also, do not continue to rotate the coarse focus knob after the stage has reached the upper or lower limit of its motion. These actions will damage the microscope.

7. Objectives

When observing suspended cells in the container, it is necessary to set the objective closer to the container than usual in order to achieve proper focus. If the objective is switched while set this close, it will strike the end of the container. Lower the objective before rotating the revolving nosepiece when it has been set close like this.

Also, before placing large containers on the stage, be sure that the tip of the objective does not stick out farther than the stage surface.

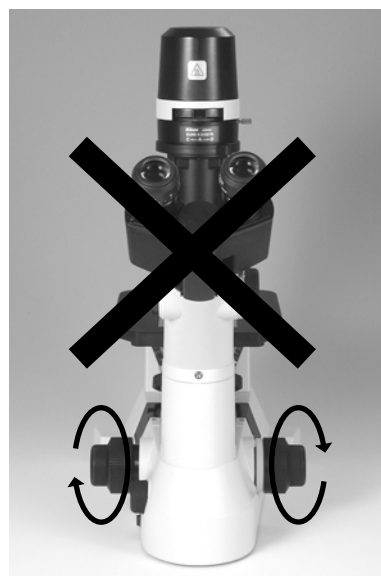

Do not twist in opposite directions.

8. ϕ 35-mm Petri dishes

When using a ϕ 35-mm Petri dish, always attach the supplied round-holed ring to the stage. Using the long-holed ring instead may result in the dish falling through the opening.

9. Oil-immersion observation

Use only a minimum quantity of oil. If too much oil is applied, surplus oil may flow out to the stage and the condenser which may lead to degraded performance.



WARNING

When using petroleum benzine or absolute alcohol to wipe off immersion oil or to clean the lenses, follow the instructions provided by their manufacturers. Absolute alcohol and petroleum benzine are inflammable. Take great care when handling them.

1 Names of Parts

This microscope consists of the parts shown in the figure below.

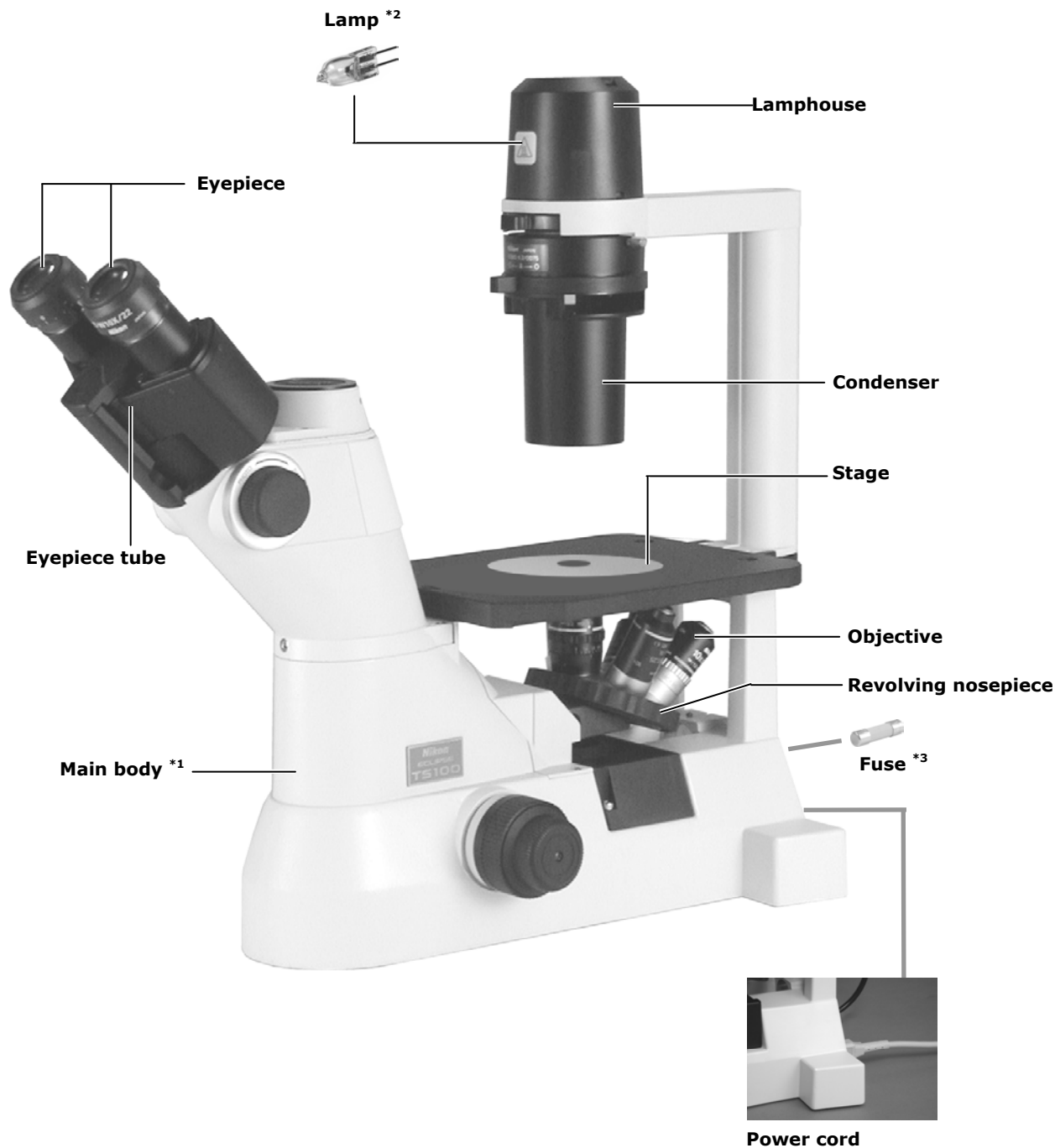

*1 This photo shows an example of ECLIPSE TS100-F with ELWD condenser.

*2 The light source for ECLIPSE TS100/TS100-F is halogen lamp, and the light source for ECLIPSE TS100LED MV/TS100LED-F MV is white LED.

*3 ECLIPSE TS100LED MV/TS100LED-F MV is designed for AC power of 100 to 240 V AC and 50/60 Hz, thus has no fuse.

2

Names of Operational Parts

Filter holder

Holds up to two filters, such as the GIF filter for phase contrast microscopy and NCB filter (for TS100/TS100-F only) for bright-field microscopy. Holds a diffuser as standard for TS100 LED MV/TS100LED-F MV. For filter types, see Chapter 4, "Operation of Each Part - 4 Filters".

Condenser aperture diaphragm lever

Moving the lever to the right opens the aperture and moving the lever to the left closes the aperture. Closing down the aperture allows observation of transparent specimens even under bright-field microscopy though its resolution is reduced. Fully open the aperture diaphragm during phase contrast microscopy. During bright-field microscopy, close the aperture diaphragm to 70% of the numerical aperture of the objective to get a sharp image with good contrast. (The aperture diaphragm lever works the same for NAMC condenser. Fully open the aperture diaphragm during NAMC microscopy.)

Diopter adjustment rings

Adjust independently to compensate for the difference between your right and left eyes. (P.15)

Optical path changeover knob (for TS100-F/TS100LED-F MV only)

Switches the light path between the binocular eyepieces and the vertical tube. PHOTO: 0% to the eyepieces and 100% to the vertical tube. BINO: 100% to the eyepieces and 0% to the vertical tube.

Vertical tube (for TS100-F/TS100LED-F MV only)

Accepts various types of adaptors to allow the attachment of a camera or other photomicrographic equipment.

Brightness adjuster

Turn clockwise to increase voltage to the lamp and to brighten the viewfield. Turn counterclockwise to decrease voltage to the lamp and to darken the viewfield.

Power switch

Press the power switch to the "I" position to turn on the power and to light up the lamp. (The switch also lights.) Press the power switch to the "O" position to turn off the power and to turn off the lamp. (The switch also goes off.)

Lamphouse cover

To remove the cover, press the front and back hem and pull upward. Before replacing the lamp, (1) turn off the power, (2) unplug the power cord, and (3) wait for the lamp to cool.

Illumination pillar

Condenser clamp screw

Slider installation hole

This hole allows the installation of a phase slider. (The NAMC condenser has the hole for installing the NAMC slider.)

Mechanical stage installation screw holes (bottom panel)

Water tray

Water tray cover clamp screw

Fine focus knob

Coarse focus knob

Coarse torque adjustment ring

Adjusts rotation torque of the coarse focus knob. (P.25)

Nameplate

AC inlet

Fuse holder (voltage selector) (for TS100/TS100-F only)

Lamp cable connector

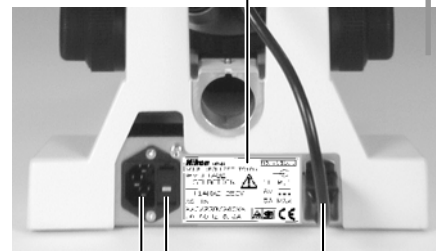
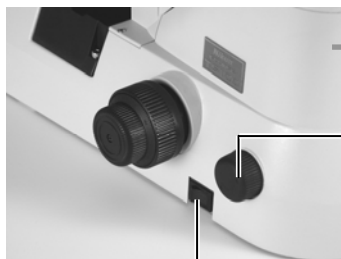

This photo shows an example of ECLIPSE TS100-F with ELWD condenser.

3

Microscopy

1

Microscopy

1 Turn on the lamp.

Turn on the power to the microscope (press the power switch to the "O" position) to turn on the lamp. Adjust the brightness of the viewfield with the brightness adjuster. (Turn clockwise to increase brightness. Turn counterclockwise to decrease brightness.)

When using the TS100-F/TS100LED-F MV, set the optical path changeover knob to BINO before adjusting the brightness of the viewfield.

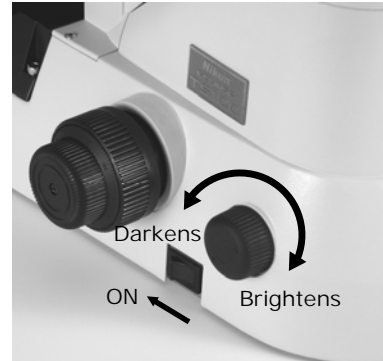

2 Adjust the interpupillary distance.

Looking through the eyepieces, adjust the distance between the binocular tube so that the right and left viewfields overlap to form a single image. (This operation sets the distance between the eyepieces to match that between the operator's eyes.)

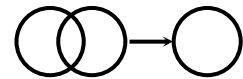

Adjust so the right and left viewfields form a single image.

3 Set the diopter adjustment ring to the reference position.

Turn the diopter adjustment ring on the right eyepiece to align the 0 line with the reference line. Also align the 0 line of the left diopter adjustment ring with the reference line.

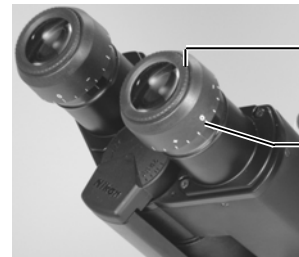

Diopter adjustment ring

Reference line

4 Fully open the aperture diaphragm.

Move the aperture diaphragm lever on the condenser to the full right to fully open the aperture.

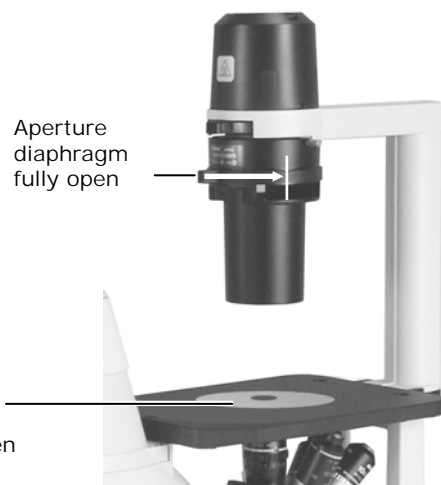

5 Set the specimen in place.

Place a specimen on the stage. Adjust its position so that the center of the container (that has the even thickness) comes under the optical path. When using a ϕ 35-mm Petri dish, always attach the supplied round-holed ring to the stage to prevent the dish from falling off. (See P.24 when using other containers.)

6 Adjust the diopter.

Adjust the diopter adjustment rings of the eyepieces according to the visual power of your right and left eyes. Once this adjustment is complete, full performance of the objectives will be properly achieved, including their parfocality.

- (1) If a phase slider or NAMC slider is set, enter an empty hole into the optical path or remove the slider from the condenser.
- (2) Place the 10x objective in the optical path. Turn the coarse and then the fine focus knob to bring the specimen into focus.
- (3) Place the 40x objective in the optical path, and turn the focus knobs to bring the specimen in focus. (When the 40x objective has a correction ring, adjust it to compensate for the thickness of the container. See P.27 for details.)
- (4) Place the 10x objective in the optical path again. Look through the right eyepiece with your right eye and, without touching the focus knobs, turn the right diopter adjustment ring to bring the specimen into focus.
- (5) Look through the left eyepiece with your left eye and, without touching the focus knobs, turn the left diopter adjustment ring to bring the specimen in focus.
- (6) Repeat steps (3) to (5).
- (7) If a phase slider or NAMC slider was removed, return it to its original position.

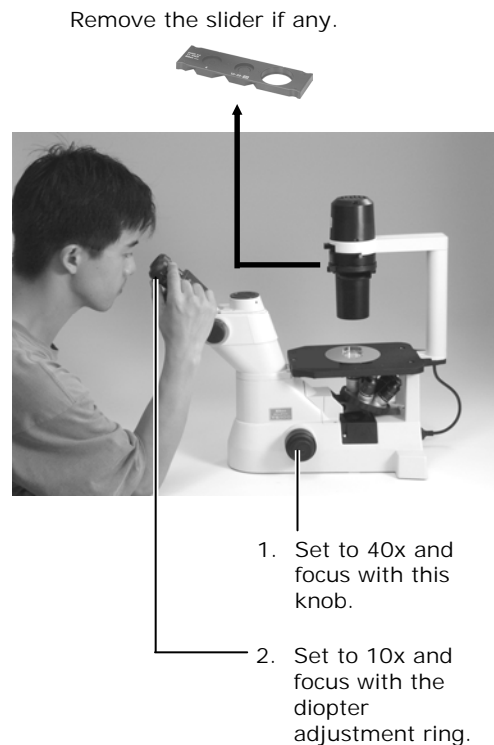

7 Bring the diffuser into the optical path. (for TS100LED MV/ TS100LED-F MV only)

Insert the diffuser into the filter holder and bring it into the optical path. The pearskin finish (rough side) surface of the diffuser should face upwards when attaching it to the filter holder.

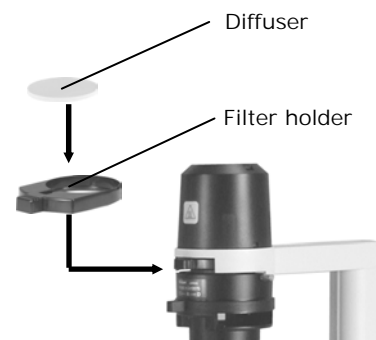

8 Observe the specimen.

Observe the specimen using the optimal microscopy method.

For phase contrast microscopy, go to "1-1 Phase Contrast Microscopy".

For modulation contrast (NAMC) microscopy, go to "1-2 Modulation Contrast (NAMC) Microscopy".

For bright-field microscopy, go to "1-3 Bright-field Microscopy".

9 Turn off the lamp.

Press the power switch to the "○" position to turn off the lamp. After the lamphouse cools, cover the microscope with a vinyl cover to prevent dust.

1-1

Phase Contrast Microscopy

In order to perform phase contrast microscopy, the following items are required: an ELWD condenser, objectives for phase contrast microscopy, a phase slider (either non-centerable or centerable), an annular diaphragm Ph2 (when Ph2 objective is used), a GIF filter and a centering telescope (only when a centerable phase slider is used).

Before proceeding to the following operations, perform steps 1 to 6 in "1 Microscopy".

1 Attach the ELWD condenser.

Attach the ELWD condenser to the illumination pillar.

2 Attach the phase slider.

Insert the phase slider into the condenser.

(When you are planning to use a Ph2 objective, attach the annular diaphragm Ph2 to the slider in advance.)

3 Insert a GIF filter.

Insert a GIF filter into the filter holder and bring it into the optical path. (Voluntary.)

The GIF filter will improve the contrast of the phase contrast image.

4 Fully open the aperture diaphragm.

Move the aperture diaphragm lever on the condenser to the rightmost to fully open the aperture. Always fully open the aperture diaphragm for phase contrast microscopy. If the aperture diaphragm is closed, it will obstruct the annular diaphragm and the phase contrast effects cannot be obtained.

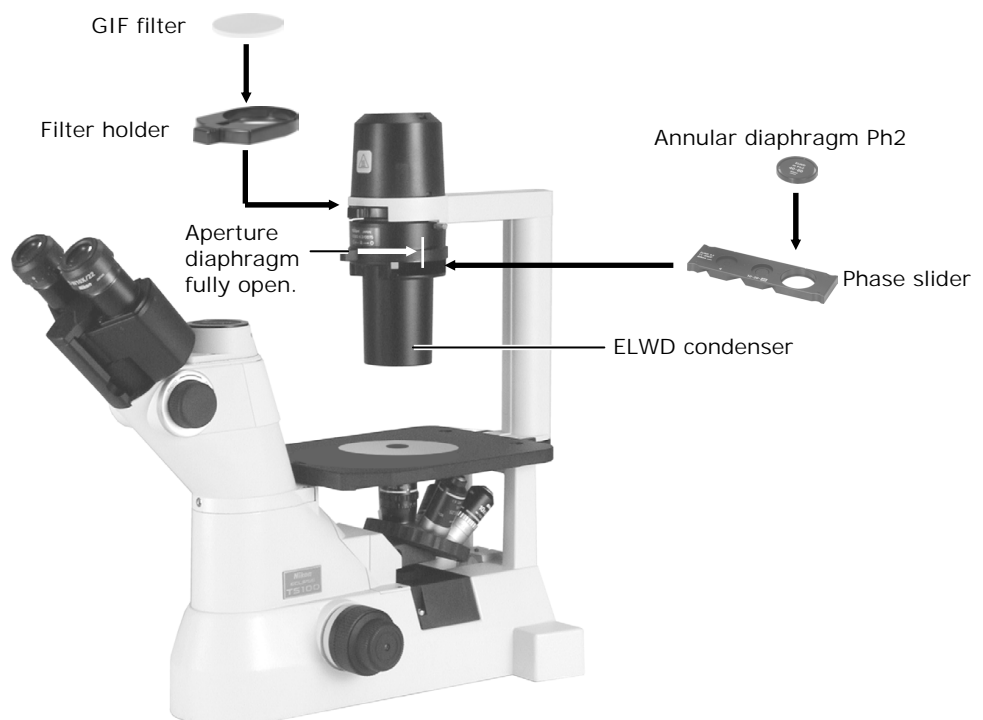

5 Center the annular diaphragm. (Only when using a centerable phase slider.)

Center the annular diaphragm so that it aligns with the phase ring of the objective. Perform this adjustment with the center of the container (having an even thickness) in the optical path. Avoid the periphery of the container.

- (1) Place the 10x phase contrast objective (Ph1) in the optical path.
- (2) Slide the phase slider to place the Ph1 annular diaphragm in the optical path.
- (3) Taking care not to alter the position of the diopter adjustment ring, remove one eyepiece from the eyepiece tube and insert a centering telescope in its place.
- (4) Holding down the flange of the centering telescope, turn the eyepiece of the centering telescope and focus on the objective phase ring.
- (5) Insert two hexagonal screwdrivers into the centering holes on the phase slider and, while looking through the centering telescope, center the Ph1 annular diaphragm image so that it aligns with the phase ring.
- (6) If you are using an objective with a Ph code other than Ph1, place that objective and the annular diaphragm having the same Ph code as that objective in the optical path, and center the annular diaphragm in the same manner described above.

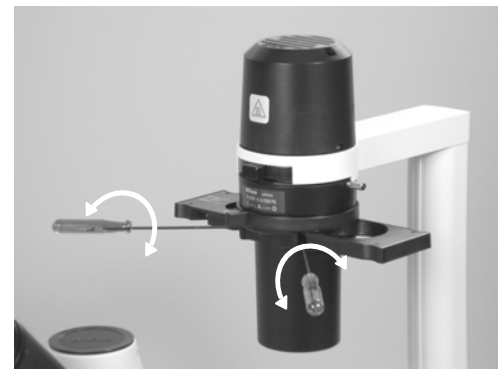
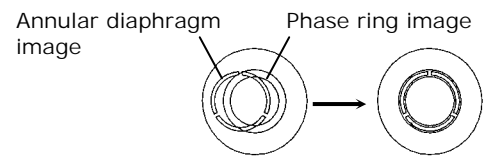
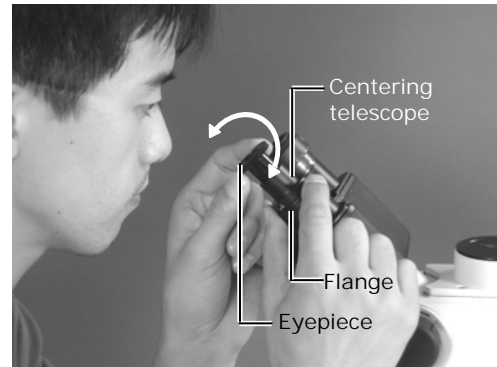

Place the annular diaphragm having the same Ph code as the objective in the optical path.



6 Select the desired phase contrast objective.

Turn the revolving nosepiece and place the phase contrast objective of the desired magnification in the optical path. (Turn the revolving nosepiece until you feel it click in place.)

7 Place the annular diaphragm corresponding to the objective in the optical path.

Place the annular diaphragm having the same Ph code as the objective in the optical path and observe. Since optical conditions worsen by the difference in the thickness of the container depending on the location, the center of the annular diaphragm may become displaced. If the contrast suddenly worsens, check the condition of the setup and, if necessary, center the annular diaphragm again.

8 Adjust the correction ring on the objective.

If the objective has a correction ring, adjust the ring according to the thickness of the container. For details, see P.27.

1-2**Modulation Contrast (NAMC) Microscopy**

In order to perform NAMC microscopy, the following items are required: an NAMC condenser, objectives for NAMC, an NAMC slider (with slit diaphragms), and a centering telescope.

Before proceeding to the following operations, perform steps 1 to 6 in "1 Microscopy".

1 Attach the NAMC condenser.

Attach the NAMC condenser to the illumination pillar.

2 Attach the NAMC slider.

Insert the NAMC slider into the condenser.

(Attach the slit diaphragm to the NAMC slider in advance if the slit diaphragms are removed from the slider. See P.36 for details.)

3 Fully open the aperture diaphragm.

Move the aperture diaphragm lever on the condenser to the rightmost to fully open the aperture. Always fully open the aperture diaphragm for NAMC microscopy. If the aperture diaphragm is closed, it will obstruct the slit diaphragm and the proper image cannot be obtained.

Remove all unwanted filters.

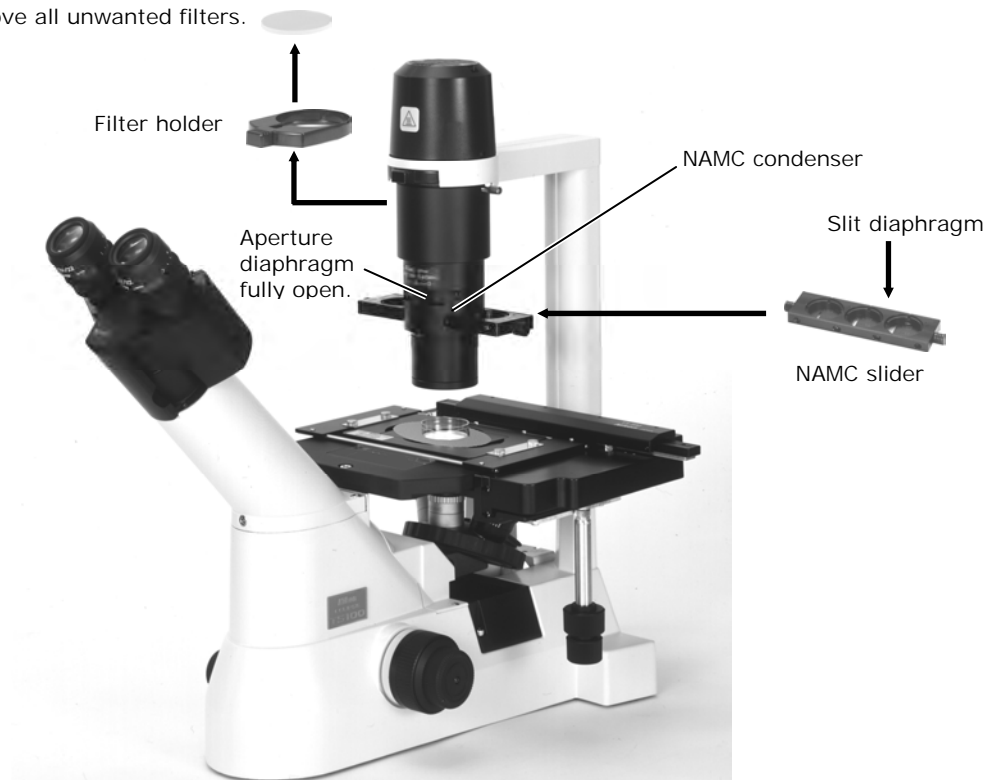

4 Orient the slit diaphragm.

Orient the slit diaphragm so that it properly overlaps the modulator (focal plane pattern) on the NAMC objective.

- (1) Place the 10x NAMC objective (NAMC1) in the optical path.
- (2) Slide the NAMC slider to place the NAMC1 slit diaphragm in the optical path.
- (3) Taking care not to alter the position of the diopter adjustment ring, remove one eyepiece from the eyepiece tube and insert a centering telescope in its place.
- (4) Holding down the flange of the centering telescope, turn the eyepiece of the centering telescope and focus on the objective modulator (focal plane pattern) and slit diaphragm image.
- (5) Taking care not to alter the position of the correction ring on the objective (if any), turn the modulator pattern in the direction in which you wish to apply contrast. Be sure at this time, to closely observe where the slit diaphragm image is located versus the modulator pattern.
- (6) Remove the NAMC1 slit diaphragm from the optical path. Then, using a hexagonal screwdriver, press one of the grooves in the slit diaphragm's circumference and rotate the diaphragm so that the lengthwise direction of the slit image becomes parallel to the modulator's G area. (Re-insert the NAMC1 slit diaphragm in the optical path to check whether or not the two are parallel. For fine adjustment, turn the modulator ring.)
- (7) Insert two hexagonal screwdrivers into the centering holes of the NAMC slider. Then, while looking through the centering telescope, adjust so that the slit diaphragm image perfectly overlaps the modulator's G area.
- (8) If you are using an objective with an NAMC code other than NAMC1, place that objective and the slit diaphragm having the same NAMC code as that objective in the optical path and orient them in the same manner described above.

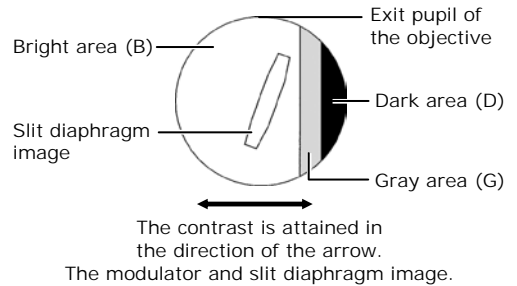
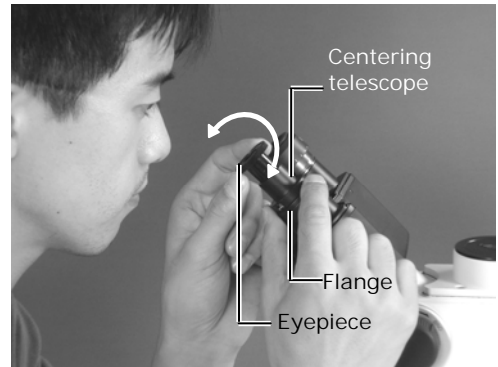

NAMC objective

Modulator ring

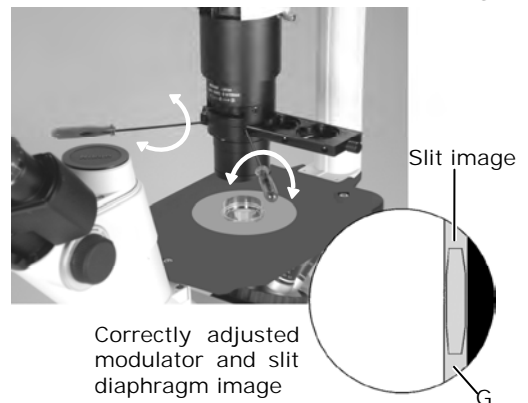
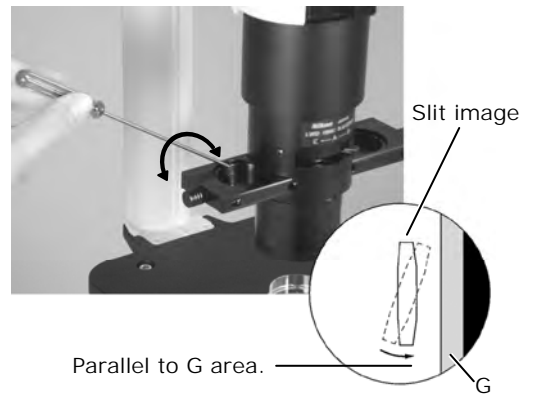

5 Select the desired NAMC objective.

Turn the revolving nosepiece and place the NAMC objective having the desired magnification in the optical path. (Turn the revolving nosepiece until you feel it click in place.)

6 Place the slit diaphragm corresponding to the objective in the optical path.

Place the slit diaphragm having the same NAMC code as the objective in the optical path and observe.

Depending on the specimen, changing the direction of the contrast may make easier observation.

Change the direction of the specimen by rotating the container, or change the direction of the modulator and slit diaphragm as necessary.

7 Adjust the correction ring of the objective.

If the objective has a correction ring, adjust the ring according to the thickness of the container. For details on adjusting this correction ring, see P.27.



Place the slit diaphragm having the same NAMC code as the objective in the optical path.

1-3 Bright-field Microscopy

Before proceeding to the following operations, perform steps 1 to 6 in "1 Microscopy".

1 Remove the annular diaphragm and slit diaphragm from the optical path.

If a phase slider or NAMC slider is set, enter an empty hole into the optical path or remove the slider.

2 Insert an NCB filter. (for TS100/TS100-F only)

Insert an NCB11 filter into the filter holder to change the illumination to the white light. Since the color temperature differs by the lamp voltage, turn the brightness adjuster till the background color becomes white. If the viewfield becomes too bright by this adjustment, add an ND filter to the filter holder.

3 Switch to the desired objective.

Turn the revolving nosepiece to enter the desired objective in the optical path. (Turn the revolving nosepiece until you feel it click in place.)

4 Adjust the aperture diaphragm.

Adjust the size of the aperture diaphragm so that it is 70% to 80% of the numerical aperture of the objective.

For details on adjusting the aperture diaphragm, see P.23.

Note that the aperture diaphragm is attached to the condenser and cannot be adjusted if the condenser has been removed.

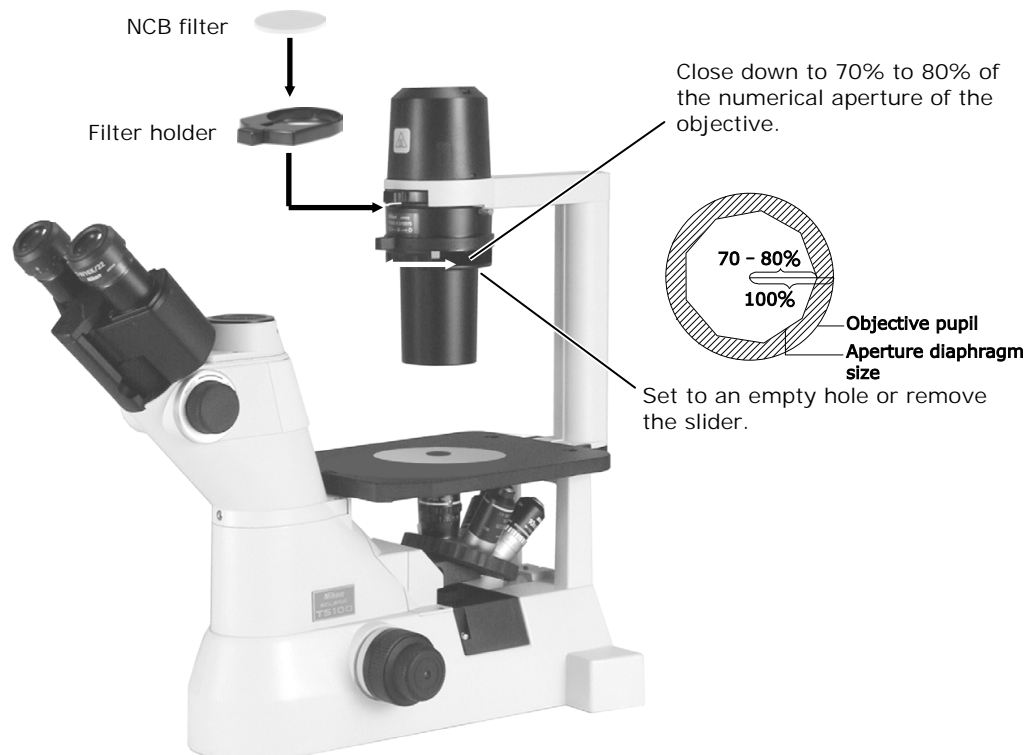

4

Operation of Each Part

1

Aperture Diaphragm

The aperture diaphragm adjusts the numerical aperture (N.A.) of the illumination system.

Aperture of this diaphragm determines optical resolution, brightness, contrast, and depth of focus. Narrowing down the aperture diaphragm decreases resolution and brightness, and increases contrast and depth of focus. Because these characteristics are interrelated and cannot be controlled one by one, the aperture must be adjusted for each specimen and application.

Adjustment of the aperture diaphragm is especially important for bright-field microscopy, differential interference contrast microscopy, and photomicrography. Generally, aperture settings of 70 to 80% of the objective N.A. yield good images of appropriate contrast.

Adjust the aperture of the diaphragm while actually observing the diaphragm image through the eyepiece tube. Leftward rotation of the aperture diaphragm lever stops down the diaphragm. Rightward rotation opens it.

Remove one eyepiece, then insert the centering telescope. Hold the flange of the centering telescope with one hand and rotate its eyepiece for focusing. The images of the objectives exit pupil (appears bright round) and the aperture diaphragm become visible. (If the image of the aperture diaphragm is not seen, stop down the aperture diaphragm further.) While observing these images, adjust the aperture diaphragm lever until the aperture of the diaphragm reaches 70 to 80% of the exit pupil of the objective.

Be sure to always fully open the aperture diaphragm when performing phase contrast microscopy. If the aperture diaphragm is closed, it will obstruct the annular diaphragm and the phase contrast effects cannot be obtained.

Be sure to always fully open the aperture diaphragm when performing NAMC microscopy. If the aperture diaphragm is closed, it will obstruct the slit diaphragm and a proper image cannot be obtained.



Condenser aperture diaphragm lever

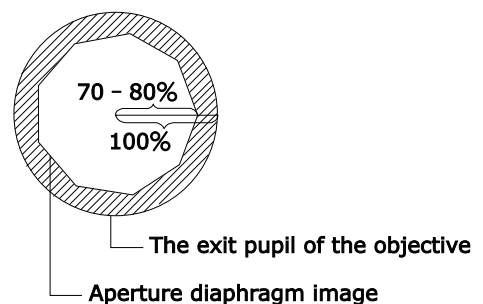
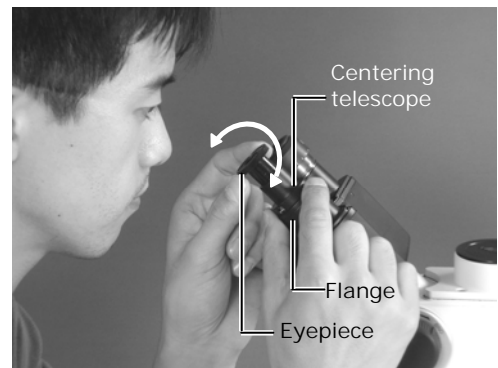

The appropriate size of the aperture diaphragm

2 Specimen and Stage

1 Round-holed and long-holed rings

When using a small container such as ϕ 35-mm Petri dish, always attach the supplied round-holed ring to the stage. Using the long-holed ring instead may result in the dish falling through the opening.

Attach the long-holed ring to the stage when using relatively large containers, such as microplates.

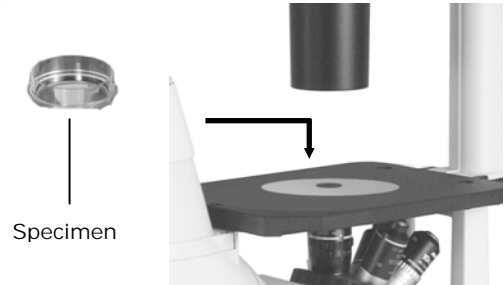

2 Observing suspended cells

When observing suspended cells in the container, it is necessary to set the objective closer to the container than usual in order to achieve proper focus. If the objective is switched while set this close, it may strike the edge of the container. Be sure to first lower the objective before rotating the revolving nosepiece when it has been set close like this.

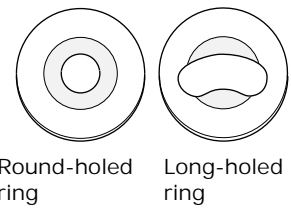

3 Using the mechanical stage

For details on attaching the mechanical stage, see P.37.

Turning the upper knob of the mechanical stage moves the stage back and forth while turning the lower knob moves it right and left. Take care not to bend the specimen holder frame as it is coupled with a thin plate.

96-hole plates can be directly inserted into the specimen holder frame. Insert other containers into the specimen holder frame using the assorted specimen holders.

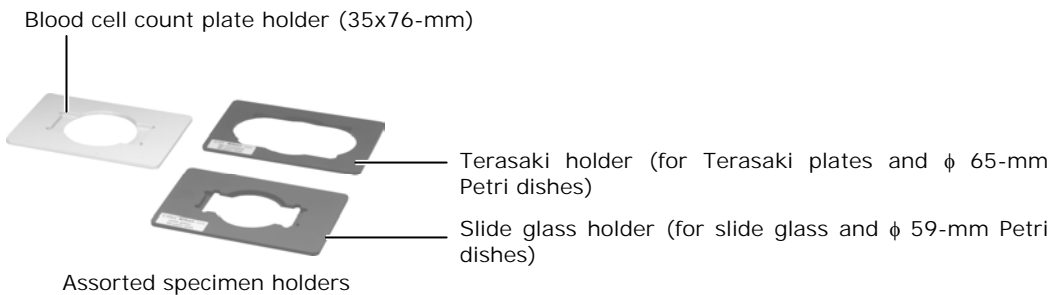
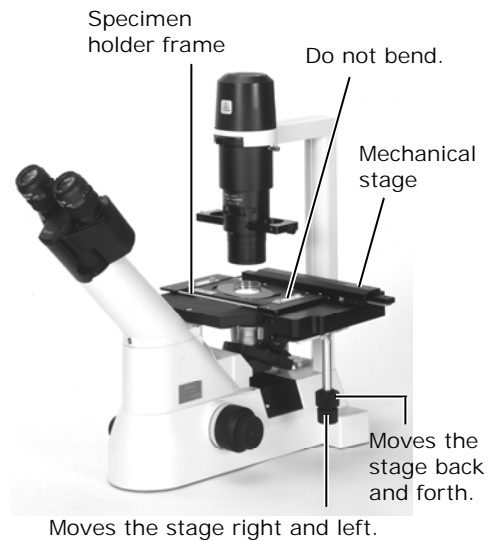

4 Using large containers

When using oblong containers, more stable observations are possible by attaching a sub-stage to the sides of the stage. (For details on attaching the sub-stage, see P.37.)

When using a large, thick container, remove the condenser and place the container on the stage. Note that only simple bright-field microscopy is possible while the condenser is removed.

Before placing a large container on the stage, check that the tip of the objective does not stick out beyond the top surface of the stage.

Remove the condenser for observations when using a large container.

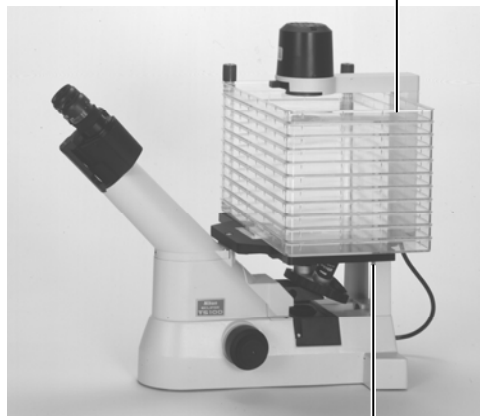

Sub-stage

3 Focusing Device

The arrows in the figure show the directions in which you rotate the focus knob to move the objectives.

The following shows the relationship between rotation of the knobs and movement of objective:

One scale division on the fine focus knob gives 2 μm of objective movement.

One rotation of the fine focus knob gives 0.2 mm of objective movement.

One-tenth rotation of the coarse focus knob gives 3.8 mm of objective movement.

The coarse/fine focus knobs provide a 7-mm upward stroke and 3-mm downward stroke from the reference position.

The torque of the coarse focus knob can be changed by turning the coarse torque adjustment ring located at the base of the coarse focus knob on the right. Turning this adjustment ring counterclockwise increases the torque, while turning it clockwise decreases the torque. The torque of the coarse focus knob is pre-adjusted at the factory, but can be adjusted to taste by the user. Take care not to over-loosen the torque so that the revolving nosepiece does not fall of its own weight.

Do not rotate the right and left focus knobs in opposite directions at the same time or continue turning the coarse focus knob after the stage has reached the limit of its motion as this may result in damage to the equipment.

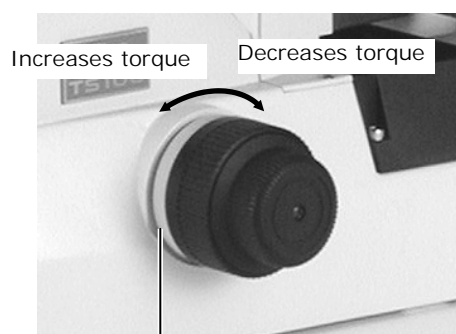
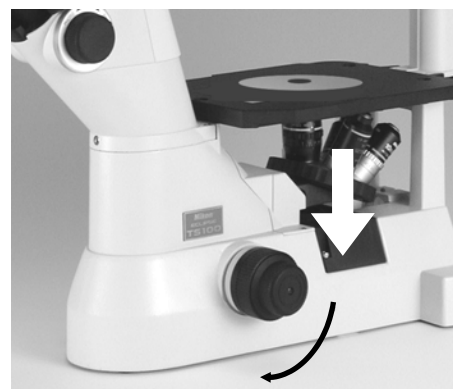

Coarse torque adjustment ring

4

Filters

It is possible to insert up to two filters in the filter holder located under the lamphouse. The following filters are available for use as required by the application.

ND2 filter:	For brightness adjustment on normal microscopy and photomicrography. Reduces light quantity to 1/2. (Approx. 50% transmissivity)
ND8 filter:	For brightness adjustment on normal microscopy and photomicrography. Reduces light quantity to 1/8. (Approx. 12.5% transmissivity)
NCB11 filter:	For correcting the color temperature on normal microscopy and on color photomicrography (day light type). Remove this filter from the optical path when making photomicrography with tungsten type color film or monochrome film.
GIF:	Green interference filter. For improving the contrast in microscopy with monochromatic light and in monochrome photomicrography.
Heat insulation filter:	For reducing the influences of heat rays in the illumination light on the sample. Use the heat insulation filter for a sample quite sensitive to heat, though the microscope has a built-in heat insulation filter.

Diffuser: For TS100LED MV/TS100LED-F MV, as a diffuser is inserted in the filter holder as standard, only one more filter can be inserted.

5

Objectives**1 Ph codes**

A Ph code (PhL, Ph1 or Ph2) is printed on each of the objectives for phase contrast microscopy. Regardless of the magnification of the objective, be sure to insert the annular diaphragm having the same Ph code as the objective in the optical path when performing phase contrast microscopy. (The annular diaphragm must also be centered when using a centerable phase slider before making observations.)

Although Nikon also offers an objective for phase contrast microscopy with a Ph code of Ph3, this objective is for high-magnification applications and cannot be used for phase contrast observation with this microscope.

2 NAMC codes

An NAMC code (NAMC1, NAMC2 or NAMC3) is printed on each of the objectives for NAMC microscopy. Regardless of the magnification of the objective, be sure to insert the slit diaphragm having the same NAMC code as the objective in the optical path when performing NAMC microscopy. (The slit diaphragm position must also be aligned with the NAMC objective modulator before making observations.)

3 Objective with correction ring

An inverted microscope is frequently used to observe specimens through the bottom plate (made of glass or plastic) of a laboratory dish or culture bottle. For such applications, because the bottom plate thickness differs, the normal objectives (for 0.17 mm thick cover glass) may not provide clear images, disabling the microscope from demonstrating its full performances. In such cases, use an objective with a correction ring to compensate for bottom plate thickness. The objectives with correction rings are not intended to compensate for wedge-like changes of thickness at edges of a container. We recommend that they should be used for compensation for even thickness.

Adjusting the correction ring

- (1) Adjust the scale of the correction ring to the thickness of the bottom plate of the container. This thickness should be a measured value or the value stated by the container manufacturer.
- (2) Focus on the specimen with the focus knob.
- (3) Rotate the correction ring clockwise or counterclockwise slightly if the image has poor resolution and/or contrast. When the correction ring is rotated, the specimen image becomes slightly out of focus. Adjust the focus again with the fine focus knob.
- (4) If the resolution and contrast are improved, rotate the correction ring further in the same direction, then adjust the focus again.
If the resolution and contrast are deteriorated, rotate the correction ring in the reverse direction by the amount about double the previous turn, then adjust the focus.
In this way, rotate the correction ring in the same direction if a better image is obtained, or rotate it in the reverse direction if a poor image is obtained. Repeat this operation to find the best point.

The 0 mm position of the correction ring is used for microscopy of a specimen with no cover glass.

We recommend that you take a note of the reading of a well-visible position on the correction ring.

Your note should help when you later use containers having different bottom plate thickness.

4 Cover glass and slide glass thickness

A specified cover glass thickness is indicated on each objective. (" ∞ /0.17" indicates a cover glass thickness of 0.17 mm.)

For an objective with a 0.17 mark, place a specimen so that its cover glass (0.17 mm thick) faces the objective. (For an inverted microscope, set a specimen so that its cover glass faces down.) An objective with a 1.2 mark is for a slide glass with thickness of 1.2 mm. Place a specimen so that its slide glass faces the objective. (For an inverted microscope, set a specimen so that its cover glass faces up.)

When you observe a specimen in a laboratory dish or the like at high magnification through a glass not conforming to the specified thickness, we recommend use of an objective that has a correction ring capable of correcting the glass thickness error.

5 Oil immersion objectives

Objectives which have a black band around the tip and on which "Oil" is printed are oil immersion objectives. Oil immersion objectives are used by filling Nikon immersion oil between the tip of the objective and the specimen. Use non-fluorescent oil when performing fluorescence microscopy with an oil immersion objective intended for fluorescence microscopy.

Take care not to allow air bubbles

When filling with oil, take care that no air bubbles form inside the oil. The presence of air bubbles degrades the viewed image. To check for air bubbles, remove one eyepiece, fully open the aperture diaphragm, and look at the exit pupil of the objective (appears bright round). If it is difficult to see, remove one of the eyepieces, attach a centering telescope in its place, and observe while changing the focus by rotating the eyepiece of the centering telescope.

If there are bubbles in the oil, remove them by one of the following methods:

- Turn the revolving nosepiece slightly, moving the oil-immersed objective back and forth once or twice.
- Add more oil.
- Remove the oil and replace it with new oil.

Handling immersion oil

Use as little oil as possible. If too much oil is applied, the excess will flow onto the stage and other parts.

Any oil remaining on an oil-immersion type of objective or staining on the tip of a dry type of objective has a negative effect on viewing. After using oil, wipe all of it away and make sure that there is no oil on the tips of the other objectives.

To wipe away oil, wipe lightly 3 or 4 times using lens tissue dampened with absolute alcohol (ethyl alcohol or methyl alcohol). Items may be wiped more cleanly by making sure not to wipe with the same part of the tissue more than once. A nice finish may be obtained by wiping again with dry lens tissue.

**WARNING**

When using absolute alcohol, always follow the instructions provided by the manufacturer. Keep these flammable liquids away from fire or sparks.

Precautions when using immersion oil

- Make sure to securely tighten the cap after use. After adding oil to the container, securely tighten the base cap. Since the base cap may become loose by itself after having been used for a long time, periodically check to make sure it is tight. Oil may leak out if the cap is loose.
- Do not press on the container with excessive force. This may cause the oil suddenly spray from the container.
- Wipe off any oil that collects on the outside of the container during the course of use.
- Be careful so that oil does not get in your eyes. Although the Nikon immersion oil is not toxic, apply the first-aid measures listed below if it should come in contact with the skin or enter the eyes.
 - ◆ Contact with skin: Completely wash off with soap and water.
 - ◆ Enters the eyes: Rinse thoroughly with pure water (for at least 15 minutes) and seek medical attention.
- Do not place immersion oil in a location exposed to outside light (or UV light).

6

Modulation Contrast Method**1 Modulation Contrast (NAMC) System**

The Modulation Contrast System offers you a stable relief image which can well be compared to the differential interference contrast microscopy (DIC microscopy). But, unlike the DIC microscopy, you can observe the specimen inside the plastic containers since this system does not require its illumination to be polarized.

The Modulation Contrast System for the TS100 series is made up of two components; a pattern called "modulator" (placed at the back focal plane of the NAMC objective) and a slit diaphragm (to be installed in the NAMC slider). (The NAMC system for the TS100 series is a fixed contrast system and thus a polarized plate is not used.)

Modulators (objectives) and slit diaphragms come in pairs. Check that the NAMC codes (NAMC1, NAMC2 or NAMC3) displayed on both the modulator and the slit diaphragm are the same before using. Note that a correct image cannot be obtained if the NAMC codes do not match.

2 Principles of Modulation Contrast

Since human eyes, cameras, and films capture objects by perceiving differences in light intensity and/or color, they cannot see (or sense) the colorless, transparent cells or bacteria. These colorless transparent objects are called "phase objects" since they only change the phase of the light when the light passes through them.

The phase objects can be made visible by dyes, but their life will be deprived. In order to observe the living phase objects, differential interference contrast and phase contrast microscopy are invented, and modulation contrast microscopy likewise. The modulation contrast microscopy adopts the same optical system as the ordinary microscopes, but with some additional parts that convert the transparent specimen into the variation of light intensity. These additional parts modulate the amplitude of the light that passed through the specimen, thus changing the intensity of the light making up the visible image.

(In differential interference contrast and phase contrast microscopy, the phase objects are converted into the variations of light intensity by the phase change that occurs when the light passes through the specimen.)

Let's now think of a light that passes through a specimen. Since a phase object has the different refractive index as its surroundings, the light will be refracted at its border. (See figure 1 showing refracted light on trapezoidal phase object.) The same thing happens to every specimen.

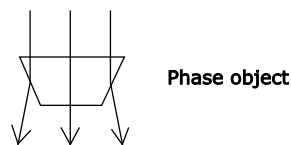

Fig. 1

6 Modulation Contrast Method

See figure 2 for the principle of the modulation contrast. There is a slit diaphragm on the condenser aperture, and modulator inside the NAMC objective. (The modulator is a density filter placed at the exit pupil of the NAMC objective. It divides the exit pupil into three regions, dark, half-dark and transparent.) If there is nothing on the specimen surface, the light passes through the half-dark region of the modulator and appears half-dark. If the light is refracted by the phase object, it passes either the dark or the bright region according to the difference in the refracted angle. The light then appears dark or bright according to the region the light passed through. In this way, the phase object is made visible. In modulation contrast microscopy, the image appears in relief just like the differential interference contrast microscopy. The notable point is that there is no influence of double refraction, thus enabling you to observe the specimen without double refraction.

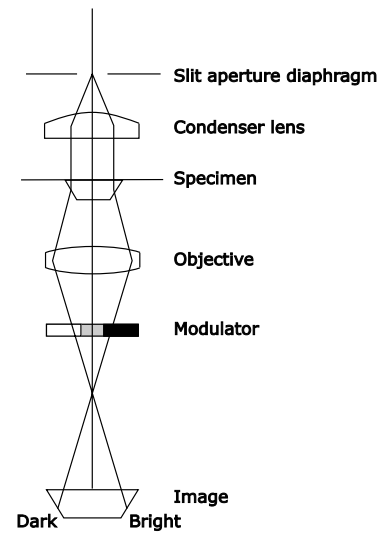

Fig. 2

7

Photomicrography (for TS100-F/TS100LED-F MV only)

When using the TS100-F/TS100LED-F MV, it is possible to attach a camera or photomicrographic equipment to the vertical tube for taking photographs or observing images on a TV monitor. See the operation manuals accompanying any cameras or photomicrographic equipment to be used for details on proper handling.

1 TV cameras and digital cameras

- (1) Connect a C-mount camera having a camera head weighing 1 kg or less (to prevent the microscope falling down).
- (2) Connect the other equipment required such as a TV monitor and video printer according to the instructions given in the camera's operation manual.



2 Photomicrographic equipment

The following items are required in order to take photographs using 35-mm film with photomicrographic equipment. Assemble in the numerical order given.



CAUTION

Do not use a large camera back on the photomicrographic equipment since the center of gravity becomes high and the microscope become unstable most likely to fall down.

- <1> Photomicrographic vertical tube (secured by two clamp screws)
- <2> PL lens (large projection lens)
- <3> Photomicrographic equipment
- <4> 35-mm film

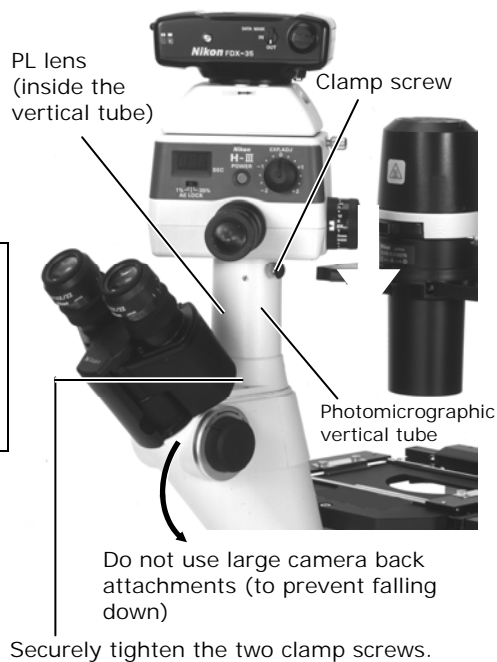

7 Photomicrography (for TS100-F/TS100LED-F MV only)

- (1) Look for the sample and make sure that illumination is even. (If illumination is uneven, make the proper adjustments.) When using an NCB11 or color correction filter with color film under diascope illumination, turn the brightness adjuster to obtain proper color and adjust the light level using ND filters.
- (2) Switch the optical path to the vertical tube. (Set the optical path changeover knob to PHOTO.)
- (3) For bright-field microscopy, adjust the aperture diaphragm on the condenser.
- (4) Turn on the power of the photomicrographic equipment.
- (5) Looking through the photomicrographic equipment's viewfinder, determine the composition of the image and bring the image into focus.
- (6) Set the light level to obtain the proper exposure time.
- (7) Press the shutter button (remote release).

3 Single lens reflex cameras

The following items are required in order to take photographs with a single lens reflex camera. Assemble in the numerical order given.

<1> Photomicrographic vertical tube (secured by two clamp screws)

<2> PL lens (large projection lens)

<3> TMS-F mount adaptor

<4> Nikon single lens reflex camera body

(Note that photometric feature of some models may not function on the TS100-F.)

<5> Eyepiece cap for camera

<6> Camera release

- (1) Look for the sample and make sure that illumination is even. (If illumination is uneven, make the proper adjustments.)
- (2) Switch the optical path to the vertical tube. (Set the optical path changeover knob to PHOTO.)
- (3) For bright-field microscopy, adjust the aperture diaphragm on the condenser.
- (4) Turn on the power of the camera.
- (5) Looking through the camera's viewfinder, determine the composition of the image and bring the image into focus.
- (6) Set the exposure time. Set the shutter dial to the position appropriate for the reading on the exposure meter when taking photographs manually or to "A" when taking photographs using automatic exposure.
To prevent vibration during mirror up of the camera, adjust the light level so that the shutter speed is 1/8 of a second or less. Extending the exposure time eliminates the photographing of vibrating images.
- (7) To prevent external light from entering, attach the eyepiece cap to the camera's viewfinder.
- (8) Click the shutter. Use the release if vibrations are a concern.

5

Assembly

Be sure to read the "Safety Precautions" and "Notes on Handling the Product" at the beginning of this manual and follow all instructions given there before assembling the microscope. In order to prevent electrical shock, also be sure to press the power switch to the "O" position to turn the power off before assembly.

1

Assembling the Basic Set

The following steps 1 to 3 are required for the TS100/TS100-F.
For the TS100LED MV/TS100LED-F MV, start from the step 4.

1 Confirming the input voltage (for TS100/TS100-F only)



WARNING

Make sure that the input voltage indicated on both the nameplate on the rear panel of the microscope and to the immediate right of the AC inlet are the same as your local voltage. Do not use the microscope if the local voltage differs from that required by the microscope. Follow the instructions below if this is the case. Use of the microscope under the incorrect voltage may cause over-heating due to over-current, possibly resulting in a fire and damaging the microscope.

- If the voltage indicated on the nameplate differs from local voltage, do not turn on the power but contact your nearest Nikon representative immediately.
- If the voltage indicated to the immediate right of the AC inlet differs from local voltage, change the input voltage setting as described below before turning on the power. The following values may be set for the input voltage.
 - If the nameplate reads "100/110/120 V ~", the input voltage may be set to 100, 110 or 120 V AC.
 - If the nameplate reads "220/230/240 V ~", the input voltage may be set to 220, 230 or 240 V AC.

Switching the voltage

Tools needed: Flathead screwdriver

- (1) Press the power switch to the "O" position to turn off the power. Unplug the power cord if it is connected.
- (2) Remove the fuse holder using a precision flathead screwdriver. (Use the tip of the minus driver to push the two lock plates toward the center of the fuse holder. The fuse holder pops out from the AC inlet.)
- (3) Remove the fuses and pull out the voltage selector inside the fuse holder.
- (4) Set the voltage selector so that the voltage displayed in the window of the fuse holder is the same as the local voltage to be used.
- (5) Re-attach the fuses and fuse holder in their original locations.

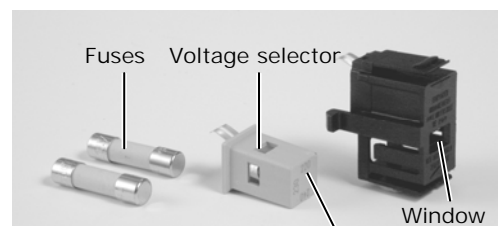
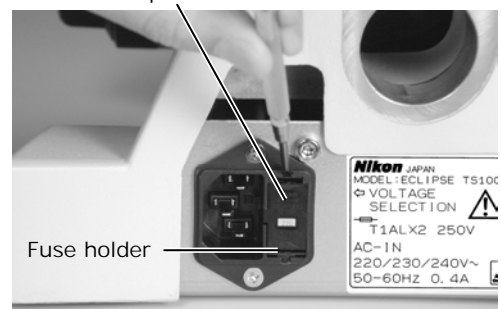
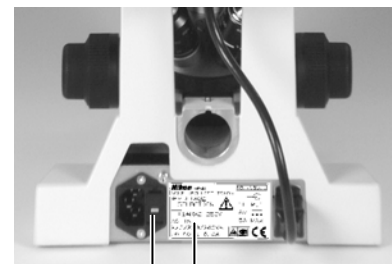

Voltage display

2 Replacing fuses (for TS100/TS100-F only)



WARNING

In order to prevent electrical shock and/or damage to equipment, be sure to turn off the microscope's power (press the power switch to the "O" position) and unplug the power cord before replacing fuses.

Use only the specified fuses. Use of other fuses may result in malfunction or fire.

Specified fuse: Two 250-V, 1-A time-lag, low-breaking 5x20 miniature fuses

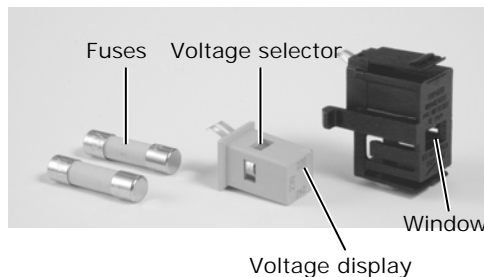

- (1) Press the power switch to the "O" position and unplug the power cord if it is connected.
- (2) Remove the fuse holder using a flathead screwdriver. (See P.33.)
- (3) Remove the fuses and replace with new fuses.
- (4) Check that the voltage displayed in the fuse holder window matches the actual input voltage. (If it differs, change the voltage selector setting according to instructions on P.33.)
- (5) Re-attach the fuse holder in its original location.

3 Attaching (replacing) a lamp (for TS100/TS100-F only)



WARNING

In order to prevent burn injury and/or electrical shock when replacing a lamp, be sure to turn off the power (press the power switch to the "O" position), unplug the power cord, and allow the lamp and its surrounding areas to cool sufficiently before opening the lamphouse cover.

Use only the specified lamp. Use of another type of lamp may result in malfunction or fire.

Specified lamp: 6 V-30 W halogen lamp (PHILIPS 5761)

- (1) Remove the lamphouse cover by lightly pressing on the front and rear hem and pulling upward.
- (2) Handling the lamp using gloves or piece of cloth, firmly plug the lamp into the socket pin holes as far as it will go.
- (3) Return the lamphouse cover to its original position.
- (4) Plug the lamp cable connector into the socket on the rear of the microscope.



4 Attaching a condenser

Slide on the condenser to the illumination pillar and secure it by a clamp screw.

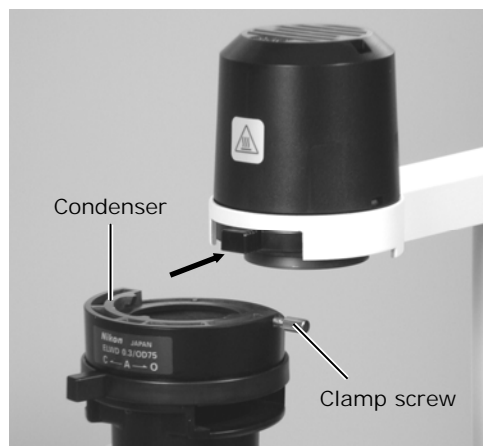

5 Attaching objectives

Objectives are screwed into the revolving nosepiece from the top of the stage. Attach objectives so that the magnification increases as the revolving nosepiece is turned clockwise as viewed from above.

6 Attaching eyepieces

Remove the caps from the binocular tube and insert eyepieces. Be sure to attach eyepieces with the same magnification.

7 Attaching a diffuser (for TS100LED MV/TS100LED-F MV only)

Insert the diffuser into the filter holder and bring it into the optical path. The pearskin finish (rough side) surface of the diffuser should face upwards when attaching it to the filter holder.



8 Connecting the power cord



WARNING

Be sure to use the provided or specified power cord which matches the power supply voltage in your local area. Use of other power cords may result in malfunction or fire.

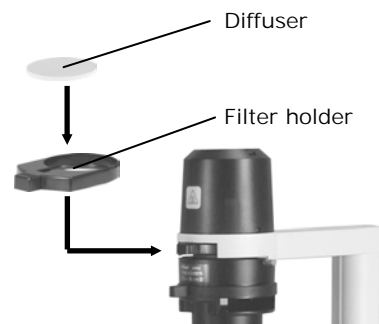

■For TS100/TS100-F

- (1) Turn off the power of the microscope (press the power switch to the "O" position).
- (2) Check the input voltage indication on the rear of the microscope and connect the correct power cord.
Make sure that the power cord is securely connected.
 - If the nameplate reads "100/110/120 V ~":
Connect the socket of the provided power cord to the AC inlet on the rear of the microscope and connect the plug to an AC electrical outlet.
 - If the nameplate reads "220/230/240 V ~":
Connect the socket of the specified power cord to the AC inlet on the rear of the microscope and connect the plug to an AC electrical outlet.

■ **For TS100LED MV/TS100LED-F MV**

- (1) Turn off the power of the microscope (press the power switch to the “O” position).
- (2) Connect the socket of the specified power cord to the AC inlet on the rear of the microscope and connect the plug to an AC electrical outlet.
Make sure that the power cord is securely connected.

This ends the assembly of the basic set.

2

Assembling Components Not Included in the Basic Set

1 Components for phase contrast microscopy

An ELWD condenser, objective for phase contrast microscopy, phase slider (either centerable or non-centerable), annular diaphragm Ph2 (when Ph2 objectives are used), GIF filter and centering telescope (only when a centerable phase slider is used) are required in order to perform phase contrast microscopy.

Attach the condenser and objectives in the same manner as described for the basic set. For details on the centering telescope, please see the description given in Chapter 3, “Microscopy”.

Insert the annular diaphragm Ph2 to the slider if you are planning to use an objective having a Ph2 indication.

Insert the slider with annular diaphragm attached into the condenser slider attachment hole.

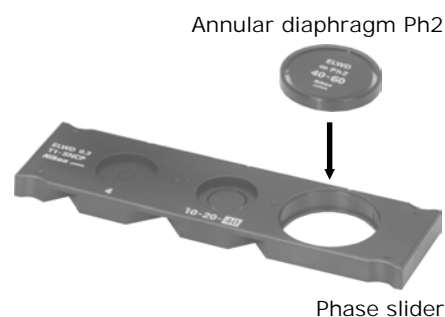

2 Components for NAMC microscopy

An NAMC condenser, objectives for NAMC, NAMC slider, slit diaphragms, and centering telescope are required in order to perform NAMC microscopy.

Attach the condenser and objectives in the same manner as described for the basic set. For details on the centering telescope, please see the description given in Chapter 3, “Microscopy”.

To remove a slit diaphragm already inserted, first sufficiently loosen the centering screws, and lift by holding the inside of the circumference. Take care not to press on the slit area.

Remove the tab on one side of the slider and insert into the condenser slider attachment hole.

Re-attach the tab in its original location.

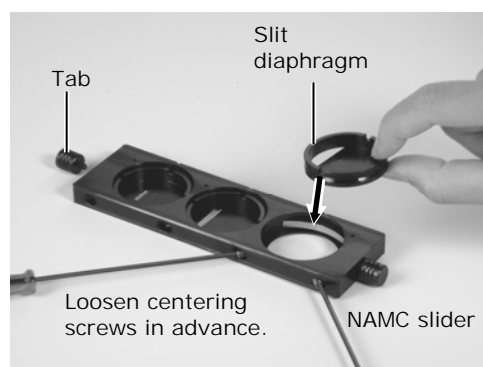

3 Mechanical stage

- (1) Remove the round-holed or long-holed ring from the stage if any is attached.
- (2) Peel off the securing tapes for transportation (at two locations).
- (3) Loosen the bolts fixing the shipping clamp for three turns.
- (4) Place the mechanical stage on top of the microscope stage and secure from the bottom of the stage using two hexagonal socket head bolts.
- (5) Remove the shipping clamp from the mechanical stage.

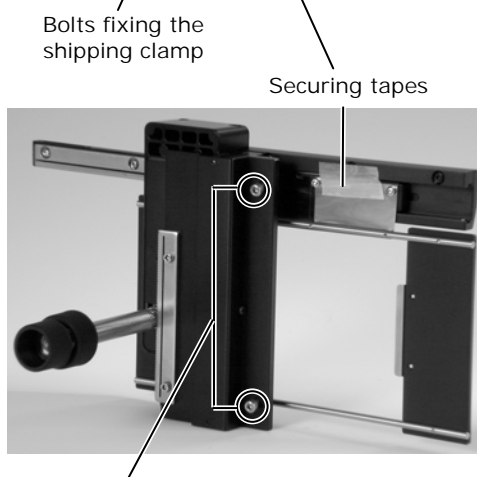
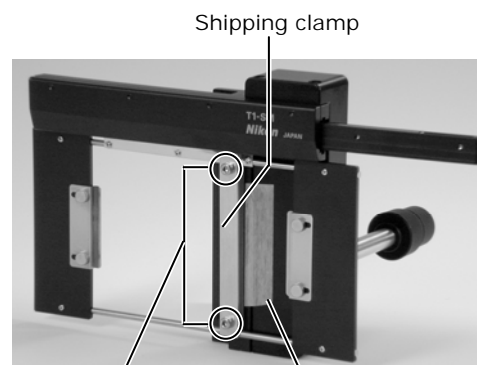

4 Sub-stages

Sub-stages are secured to the microscope's stage using the screw holes for attaching a mechanical stage.

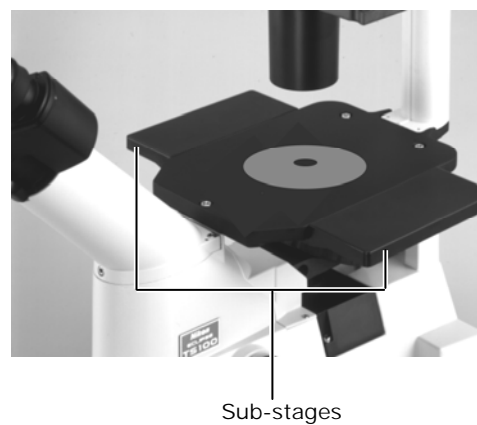

6

Troubleshooting





Misuse of this product may adversely affect performance, even if this product is properly functional. If any of the following problems occurs, be sure to check the following table for possible causes before requesting service.

If you detect problems that are not listed below or the problem still persists after measures are taken, turn off the device and contact your nearest Nikon representative.



1

Optical

Dirt or dust in viewfield.

Causes		Corrective Measures
<p>■ Dirt or dust rotates when eyepiece is turned:</p>		
Eyepiece is dirty.		Clean the eyepiece. (P.46)
<p>■ Dirt or dust does not rotate when eyepiece is turned: (1) to (4)</p>		
(1) The specimen is dirty if dirt or dust moves when specimen is moved on stage.		Clean the specimen.
(2) Objective is dirty if dirt or dust disappears when the objective is switched.		Clean the objective. (P.46)
(3) Condenser lens is dirty.		Clean the condenser. (P.46)
(4) Aperture diaphragm is too closed.		Open the aperture diaphragm to an appropriate size. (P.23)

Dirt or dust is displayed on the monitor.

Causes		Corrective Measures
<p>Dirt or dust on the monitor moves when camera is turned:</p>		
Lenses or specimen are dirty.		Check and clean by following the procedure in "Dirt or dust does not rotate when eyepiece is turned" in "Dirt or dust in viewfield."
<p>Dirt or dust on the monitor does not move when camera is turned:</p>		
Camera is dirty.		Detach the camera and clean it by following the instruction manual of the camera.

Poor image quality (No effect of phase contrast; poor contrast or resolution)

Causes	Corrective Measures
(For phase contrast microscopy:) No annular diaphragm is in optical path.	Use an annular diaphragm that matches the objective. (P.18)
(For phase contrast microscopy:) Ph codes of objective and annular diaphragm do not match.	Use an objective and annular diaphragm having the same Ph code.
(For phase contrast microscopy:) Annular diaphragm image is not centered on phase ring.	Center the annular diaphragm. (P.18)
(For phase contrast microscopy:) Aperture diaphragm is closed.	Fully open the aperture diaphragm. (P.17)
(For NAMC microscopy:) No NAMC objective is in optical path.	Place an NAMC objective in optical path.
(For NAMC microscopy:) NAMC codes of objective and slit diaphragm do not match.	Use an objective and slit diaphragm having the same NAMC code.
(For NAMC microscopy:) Slit diaphragm image is not adjusted to be contained in G area of modulator.	Adjust the position of the slit diaphragm. (P.20)
Condenser position is wrong.	Check for proper attachment to illumination pillar.
A specimen of culture container bottom thickness (slide glass thickness) or cover glass thickness specified on the objective is not used. Or the specimen is upside down.	Place a culture container (slide glass) thickness of around 1.2 mm and cover glass thickness of 0.17 mm. Place a specimen of the specified thickness faces the objective. (P.27)
Correction ring of objective is not in right position (when using objectives with correction rings).	Adjust the correction ring to match container thickness. (P.27)
Lens is dirty. (Condenser, objective, or eyepiece)	Clean the lens. (P.46)
No immersion oil is applied to the tip of an oil-immersion objective.	Apply the Nikon immersion oil. (P.27)
The Nikon immersion oil is not used.	Use the Nikon immersion oil.
The immersion oil contains air bubbles.	Remove the air bubbles. (P.28)
Immersion oil adhering to the tip of the dry-type objective. (especially, 40x objective.)	Clean it as appropriate. (P.28)

Field of view is too bright.

Causes	Corrective Measures
Lamp voltage is too high.	 Turn the brightness adjuster to attain a suitable brightness. (P.14)

Field of view is too dark.









Causes	Corrective Measures
Lamp voltage is too low.	 Turn the brightness adjuster to attain a suitable brightness. (P.14)
Aperture diaphragm is too closed.	 Open the aperture diaphragm to an appropriate size. (P.23)
Optical path is not switched to the binocular eyepieces 100%. (for TS100-F/TS100LED-F MV only)	 Switch the optical path changeover knob to "BINO" position. (P.13)
The lamp has reached the end of its product life. (for TS100/TS-100F)	 Replace the lamp. (P.34)
Input voltage is wrong.	 Set voltage selector to match the local voltage. (P.33)

Image is yellowish or very bluish. (for TS100/TS100-F only)

Causes	Corrective Measures
An NCB11 filter is not inserted.	 Insert the NCB11 filter. (P.22)
Lamp voltage is too low or too high.	 Turn the brightness adjuster to attain a suitable brightness. (P.14)

Viewfield vignetting, viewfield only partially visible, uneven brightness, or dark image

Causes	Corrective Measures
Revolving nosepiece is not in click-stop position (Objective is not in optical path).	 Rotate revolving nosepiece to click-stop position to place an objective in optical path.

1 Optical









Condenser is not installed properly.		Install the condenser correctly. (P.35)
Lamp is not installed properly. (for TS100/TS100-F only)		Install the lamp correctly. (P.34)
Dirt or dust on lens (condenser, objective, eyepiece).		Clean the lens. (P.46)
Specimen holder on the stage is in optical path.		Move the holder.
Phase slider (or NAMC slider) is in midway position.		Slide to click-stop position.
Provided diffuser is not inserted. (for TS100LED MV/TS100LED-F MV only)		Insert the diffuser into the filter holder. (P.15)
Filter is not inserted properly.		Insert the filter correctly. (P.17)
Unwanted filter is in the optical path.		Remove all unwanted filters from the optical path.
Optical path changeover knob position is wrong. (for TS100-F/TS100LED-F MV only)		Select optical path to be used. (P.13)

Image dark on one side. (One side of the viewfield (up, down, right, or left) is not focused.)



Causes		Corrective Measures
Revolving nosepiece is not in click-stop position.		Rotate to click-stop position.

Image shifts during focus. (Becomes asymmetrically defocused when moving the focal point.)

Causes		Corrective Measures
Revolving nosepiece is not in click-stop position.		Rotate to click-stop position.

2

Operational**Cannot focus even by moving objective to upper limit.**

Causes	Corrective Measures
Specimen surface is too far from stage surface.	Locate closer to stage surface.

Cannot focus with 20x or 40x objective.

Causes	Corrective Measures
Culture container is too thick.	Use a culture container of thickness 2-mm or less.



A focal deviation is high when switching over objectives.

Causes	Corrective Measures
Diopter adjustment has not been performed.	Perform diopter adjustment. (P.15)
An objective is attached incorrectly.	Screw the objective all the way in. (P.35)

Binocular images not integrated.

Causes	Corrective Measures
Interpupillary adjustment has not been performed.	Perform interpupillary adjustment. (P.14)
Diopter adjustment has not been performed.	Perform diopter adjustment. (P.15)

Eyes get tired during observations.

Causes	Corrective Measures
Interpupillary adjustment has not been performed.	 Perform interpupillary adjustment. (P.14)
Diopter adjustment has not been performed.	 Perform diopter adjustment. (P.15)
Brightness is inadequate.	 Turn the brightness adjuster to attain a suitable brightness. (P.14)







Loses focus over time.

Causes	Corrective Measures
Torque of coarse focus knob is too loose.	 Turn coarse torque adjustment ring to tighten torque so the revolving nosepiece does not fall on its own weight. (P.25)





3

Electrical



Lamp does not turn on even when power switch is on.

Causes		Corrective Measures
No electricity.		Insert the power cord into an electrical outlet. (P.35)
Power cord is not connected to the microscope main body.		Insert the power cord into the AC inlet. (P.35)
Lamp is not installed. (for TS100/TS100-F only)		Install the lamp. (P.34)
Lamp is burnt out. (for TS100/TS100-F only)		Replace the lamp. (P.34)
Not using the specified lamp. (for TS100/TS100-F only)		Use the specified lamp. (P.34)
Fuses are blown. (for TS100/TS100-F only)		Replace the fuses. (Use only the specified type.) (P.34)
Lamp cord is disconnected.		Connect to connector on rear of microscope. (P.34)

Lamp flickers. Brightness is unstable.

Causes		Corrective Measures
Lamp is about to burn out. (for TS100/TS100-F only)		Replace the lamp. (P.34)
Bad connection.		Secure all connections.
Fuse holder is not attached securely. (for TS100/TS100-F only)		Attach the holder securely. (P.34)
Room voltage is fluctuating erratically. (for TS100/TS100-F only)		Use an AC power supply with stable current meeting local safety regulations.
Lamp is not securely inserted in socket. (for TS100/TS100-F only)		Insert the lamp securely. (P.34)

Lamps burn out quickly. (for TS100/TS100-F only)

Causes		Corrective Measures
Not using the specified lamp.		Use the specified lamp. (P.34)
Input voltage is wrong.		Set voltage selector to match the local voltage. (P.33)

7

Care and Maintenance

1

Cleaning the Lenses

- Dust is best removed with a soft brush or gauze.
- More persistent dirt, such as fingerprints, grease and oil, may be removed with soft cotton, lens tissue, or gauze lightly moistened with absolute alcohol (ethyl alcohol or methyl alcohol).
- Do not use any solvents other than absolute alcohol as they may damage the lens adhesion surfaces. Especially avoid petroleum benzine when cleaning parts such as filters or the secondary objective.
- Absolute alcohol is extremely flammable. Keep this flammable liquids away from fire or sparks and when setting the power switch on and off.
- Always follow the instructions provided by the manufacturer when using absolute alcohol.

2

Cleaning the Microscope

- We recommend that you use a silicon cloth to clean the microscope.
- For persistent dirt, dampen a piece of gauze with neutral detergent and wipe lightly.
- Using organic solvent may result in discoloration of the plastic parts.

3

Disinfecting the Microscope

- We recommend that you use 70% medical alcohol for normal disinfection of the microscope.
- In case of spillage of a sample onto the microscope, determine whether the sample is hazardous. If the sample is hazardous, follow the standard procedure of your laboratory.
- Using organic solvent may result in discoloration of the plastic parts.

4

Storing the Microscope

- When the microscope is not in use, cover it with the vinyl cover, and store it in a dry place not subject to mold.
- Before covering the microscope with the vinyl cover, turn off the microscope (press the switch to the "O" position) and unplug the power cord, then wait for more than 30 minutes until the lamp and its surrounding areas cool sufficiently.
- We especially recommend that the objectives and eyepieces be kept in a container (such as a desiccator) with desiccant in it.

5

Regular Inspection (Charged)

- Regular inspection of this microscope is recommended to maintain peak performance.
- Contact your nearest Nikon representative for details about regular inspection.

1

Microscopy (Principles)

Manipulate the lever or handle of the microscope to move the observation position or change the magnification and observe or capture an image of a sample on a slide, or in a vessel such as a Petri dish or microplate.

- **Intended application of the product (for medical care)**

This microscope is intended mainly for use in microscopic observation and in the micromanipulation of living cells and tissue using diascopic (transmitted) and episcopic (reflected) illumination.

It is designed for the main purposes of experimentation and observation, in hospitals or other laboratories, of such cells and tissue within the fields of genetics, immunology, physiology, pharmacology, neurology, cellular biology, and molecular biology.

- **Intended user**

It is intended for the medical professional and those who work on experimentations in the field of genetics, immunology, physiology, pharmacology, neurology, cellular biology and molecular biology.

2

Performance Properties

(1) Model name	ECLIPSE TS100 ECLIPSE TS100-F ECLIPSE TS100LED MV ECLIPSE TS100LED-F MV
(2) Optical system	CFI60 (Infinity-corrected CF optical system)
(3) Eyepieces	10x field number: 22 15x field number: 16
(4) Microscope magnification	1×
(5) Diascopic illuminators	ELWD condenser: N.A. = 0.3, Physical distance = 75 mm NAMC condenser: N.A. = 0.4, Physical distance = 44 mm Without condenser: Physical distance = 190 mm
(6) Phase contrast microscopy equipment	PhL, Ph1, Ph2 exclusive for ELWD condenser lenses
(7) Adjustable range for interpupillary distance	50 mm to 75 mm
(8) Revolving nosepiece	5 holes

2 Performance Properties

- (9) Focusing mechanism**
- Fine focus knob graduation: 2 μm per graduation
 Fine focus knob travel: 0.2 mm up or down per turn
 Coarse focus knob travel: About 37.7 mm up or down per turn
 Vertical travel range for revolving nosepiece:
 7 mm up and 2 mm down
 from the reference position (stage surface)
- (10) Photomicrographic equipment (for TS100-F/TS100LED-F MV only)**
- Vertical tube: Accepts C-mount direct vertical tube attachments and photomicrographic vertical tube
- Optical path changeover knob: PHOTO position
 (observation 0% : vertical tube 100%)
 BINO position
 (observation 100% : vertical tube 0%)
- (11) Accepts episcopic-fluorescent attachment**
- (12) Illumination light source**
- TS100/TS100-F**
- Lamp Rating: 6 V-30 W halogen lamp (PHILIPS 5761)
 Average lamp lifetime: 100hrs
 Output Rating: 6 V 5 A max.
- TS100LED MV/TS100LED-F MV**
- White LED
- (13) Input ratings**
- TS100/TS100-F (Model for 100, 110 and 120V AC areas)**
- Input voltage: Select from 100 V, 110 V or 120 V AC by relocating the fuse holder in the AC inlet.
 - Frequency: 50/60 Hz
 - Rated current: 0.8 A or less
 - Voltage fluctuation: $\pm 10\%$
 - Fuse rating: 250 V, 1 A time-lag, low-breaking type 5x20 miniature fuse x2
- TS100/TS100-F (Model for 220, 230 and 240 V AC areas)**
- Input voltage: Select from 220 V, 230 V or 240 V AC by relocating the fuse holder in the AC inlet.
 - Frequency: 50/60 Hz
 - Rated current: 0.4 A or less
 - Voltage fluctuation: $\pm 10\%$
 - Fuse rating: 250 V, 1 A time-lag, low-breaking type 5x20 miniature fuse x2
- TS100LED MV/TS100LED-F MV**
- 100 to 240 VAC, 50/60 Hz, 0.1 A or less

(14) Power Cord**■TS100/TS100-F (Model for 100, 110 and 120V AC areas)**

- UL listed detachable power cord set.
3-conductor grounding Type SVT, No.18 AWG,
3 m long maximum, rated at 125 V AC minimum.

Use the above power supply cord only. Using the wrong power cord may result in danger or fire.

The protection class I equipment should be connected to PE (protective earth) terminal.

■TS100/TS100-F (Model for 220, 230 and 240 V AC areas)

- Approved according to EU/EN standards,
3 conductor grounding Type H05VV-F,
3 m long maximum, rated at 250 V AC minimum.

Use the above power supply cord only. Using the wrong power cord may result in danger or fire.

The protection class I equipment should be connected to PE (protective earth) terminal.

■TS100LED MV/TS100LED-F MV**• When used in 100-120 V region, outside Japan**

UL listed detachable power cord set, 3 conductor grounding
(3 conductor grounding Type SVT, No.18 AWG,
3 m long maximum, rated at 125 V AC minimum.)

• When used in 220-240 V region

Detachable power cord set approved according to EU/EN standard,
3 conductor grounding
(3 conductor grounding Type H05VV-F,
3 m long maximum, rated at 250 V AC minimum.)

• When used inside Japan

PSE approved detachable power cord set, 3 conductor grounding
(3 conductor grounding Type VCTF 3 x 0.75 mm²,
3 m long maximum, rated at 125V AC minimum.)

3 Physical Properties

(1) Model name

ECLIPSE TS100
 ECLIPSE TS100-F
 ECLIPSE TS100LED MV
 ECLIPSE TS100LED-F MV

(2) Dimension and Weight

ECLIPSE TS100:	228(W) x 517(D) x 480(H) mm,	7.5 kg
ECLIPSE TS100-F:	228(W) x 517(D) x 480(H) mm,	8.1 kg
ECLIPSE TS100LED MV:	228(W) x 507(D) x 480(H) mm,	8.5 kg
ECLIPSE TS100LED-F MV:	228(W) x 507(D) x 480(H) mm,	9.0 kg

(3) Operating Environmental Conditions

Temperature:	0 to +40°C
Humidity:	60% RH max. (no condensation)
Altitude:	2,000 m max.
Pollution:	Degree 2
Installation category: (Overvoltage category)	Category II
Electrical shock protection class:	Class I
Indoor use only	

(4) Storage and Transport Environmental Conditions

Temperature:	-20 to +60°C
Humidity:	90% RH max. (no condensation)

(5) Safety Standards Compliance

- UL listed product. (C-UL US Listing Mark approved)
- This product meets FCC Part 15 Subpart B Class A requirements:
This equipment has been tested and found to comply with the limits for a Class A digital device, pursuant to Part 15 of the FCC Rules.
These limits are designed to provide reasonable protection against harmful interference when the equipment is operated in a commercial environment.
This equipment generates, uses, and can radiate radio frequency energy and, if not installed and used in accordance with the instruction manual, may cause harmful interference to radio communications.
Operation of this equipment in a residential area is likely to cause harmful interference in which case the user will be required to correct the interference at his own expense.
- This product complies with Canadian EMI. (ICES-003 Class A)
This Class A digital apparatus complies with Canadian ICES-003.
Cet appareil numérique de classe A est conforme à la norme NMB-003 du Canada.
- CE marking
 - This product meets EU IVD Directive requirements.
(GM-approved: in vitro diagnostic medical device)
 - This product meets EU Low Voltage Directive requirements.
 - This product meets EU EMC Directive requirements. (EN61326-1, EN61326-2-6)
- This product complies with Australian EMI. (AS/NZS CISPR11 Class B)



En **Symbol for separate collection applicable in European countries**

This symbol indicates that this product is to be collected separately. The following apply only to users in European countries.

- This product is designated for separate collection at an appropriate collection point. Do not dispose of as household waste.
- For more information, contact the retailer or the local authorities in charge of waste management.

No **Symbol for kildesortering i europeiske land**

Dette symbolet indikerer at produktet skal kildesorteres. De nedenstående punktene gjelder for alle europeiske brukere.

- Dette produktet skal kildesorteres og innleveres til dedikerte innsamlingspunkter. Må ikke kastes med normalt husholdningsavfall.
- For mer informasjon, ta kontakt med din forhandler eller lokale myndigheter.

De **Symbol für getrennte Wertstoff-/Schadstoffsammlung in europäischen Ländern**

Dieses Symbol zeigt an, dass dieses Produkt separat entsorgt werden muss.

Folgendes gilt für Verbraucher in europäischen Ländern:

- Dieses Produkt darf nur separat an einer geeigneten Sammelstelle entsorgt werden. Eine Entsorgung im Hausmüll ist unzulässig.
- Wenden Sie sich für nähere Informationen bitte an Ihren Händler oder die örtlich für Abfallentsorgung zuständigen Behörden.

Se **Symbol för separat upphämtning i europeiska länder**

Den här symbolen anger att produkten måste hämtas separat. Följande gäller bara användare i europeiska länder.

- Den här produkten är avsedd för separat upphämtning vid ett lämpligt uppsamlingsställe. Produkten får inte kastas i hushållsavfall.
- För mer information, kontakta återförsäljaren eller de lokala myndigheter som ansvarar för avfallshantering.

Fr **Symbole pour la collecte sélective applicable aux pays européens**

Ce symbole indique que ce produit doit être collecté séparément. Les mesures suivantes concernent uniquement les utilisateurs européens.

- Ce produit doit être jeté séparément dans un point de collecte approprié. Ne jetez pas ce produit dans une poubelle réservée aux ordures ménagères.
- Pour plus d'information, contactez le détaillant ou les autorités locales responsables de la gestion des ordures.

Fi **Erillisen keräyksen merkki Euroopan maissa**

Tämä merkki osoittaa, että tuote kerätään erikseen. Приведенная ниже информация касается только пользователей из стран Европы.

- Tämä tuote kerätään erikseen asianmukaisista keräyspisteistä. Älä hävitä tuotetta talousjätteen mukana.
- Lisätietoja saat jälleenmyyjältä tai paikallisista jätehuoltoviranomaisista.

Es **Simbolo para recogida separada aplicable en países Europeos**

Este símbolo indica que este producto se recogerá por separado. Lo siguiente sólo se aplicará en países Europeos.

- Este producto ha sido designado para su recogida en un punto de almacenamiento apropiado. No lo tire como un deshecho doméstico.
- Para más información, contacte con el vendedor o autoridades locales al cargo de la gestión de residuos.

Ru **Символ сортировки мусора, использующийся в европейских странах**

Данный символ означает, что этот продукт должен утилизироваться отдельно от других. Приведенная ниже информация касается только пользователей в странах Европы.

- Данный продукт должен утилизироваться отдельно от других в соответствующих приемных пунктах. Не выбрасывайте данный продукт вместе с бытовым мусором.
- Дополнительную информацию Вы можете получить у продавца или у местных властей, отвечающих за утилизацию мусора.

Dk **Symbol for special bortskaffelse af denne type produkter i de europæiske lande**

Dette symbol angiver, at dette produkt skal bortskaffes specielt. Det efterfølgende er kun til forbrugere i de europæiske lande.

- Dette produkt skal bortskaffes på fx en genbrugsplads el. lign. Det må ikke smides væk som normalt husholdningsaffald.
- For yderligere information kontakt din forhandler eller de lokale myndigheder, som fx teknisk forvaltning.

Gr **Σύμβολο για την ξεχωριστή αποκομιδή απορριμμάτων στις Ευρωπαϊκές χώρες**

Αυτό το σύμβολο υποδηλώνει ότι η αποκομιδή αυτού του προϊόντος πρέπει να γίνει ξεχωριστά. Τα κάτωθι απευθύνονται μόνο σε Ευρωπαίους χρήστες.

- Αυτό το προϊόν είναι σχεδιασμένο έτσι ώστε να γίνεται η αποκομιδή του σε ειδικά σημεία. Μην το πετάτε μαζί με τα υπόλοιπα απορρίμματα.
- Για περισσότερες πληροφορίες, επικοινωνήστε με τον διανομέα του προϊόντος ή με τις υπεύθυνες τοπικές αρχές για θέματα διαχείρισης απορριμμάτων.

Nl **Symbol voor gescheiden inzameling zoals dat wordt gebruikt in Europese landen**

Dit symbool betekent dat dit product apart moet worden ingezameld. Het volgende is alleen van toepassing op gebruikers in Europa.

- Dit product dient gescheiden ingezameld te worden op een daartoe bestemd inzamelingspunt. Niet wegwerpen bij het normale huisvuil.
- Neem voor meer informatie contact op met het verkooppunt, of met de lokale instantie die verantwoordelijk is voor het verwerken van afval.

Pl **Symbol oznaczający segregowanie odpadów, stosowany w krajach Europy**

Ten symbol oznacza, że produkt musi być wyrzuczony oddzielnie. Ponizej uwagi mają zastosowanie tylko dla użytkowników z Europy.

- Ten produkt jest przeznaczony do oddzielnej utylizacji i powinien być dostarczony do odpowiedniego punktu zbierającego odpady. Nie należy go wyrzucać z odpadami gospodarstwa domowego.
- Aby uzyskać więcej informacji, należy skontaktować się z przedstawicielem przedsiębiorstwa lub lokalnymi władzami odpowiedzialnymi za zarządzanie odpadami.

Pt **Simbolo para recolha de resíduos em separado utilizado nos países Europeus**

Este símbolo indica que este produto é para ser recolhido separadamente.

Esta norma aplica-se só para os utilizadores nos países Europeus.

- Este produto está designado para recolha de resíduos em separado num recipiente apropriado. Não deitar no caixote do lixo doméstico.
- Para mais informações, contactar o revendedor ou as autoridades locais responsáveis pela gestão dos resíduos.

Hu **Európai országokban érvényes "Elkülönített hulladékgyűjtés" jelzése**

Ez a jelzés azt jelenti, hogy ezt a terméket elkülönítve kell gyűjteni. Az alábbiak csak az európai országokban élő felhasználókra érvényesek.

- Ezt a terméket a megfelelő hulladékgyűjtőhelyen, elkülönítve kell gyűjteni. Ne dobja ki háztartási hulladékként.
- További információkért forduljon a forgalmazóhoz, vagy a helyi hatóság hulladékgyűjtésért felelős részlegéhez.

It **Simbolo per la raccolta differenziata applicabile nei paesi europei**

Questo simbolo indica che il prodotto va smaltito separatamente. La normativa che segue si applica soltanto agli utenti dei paesi europei.

- Il prodotto è designato per lo smaltimento separato negli appositi punti di raccolta. Non gettare insieme ai rifiuti domestici.
- Per maggiori informazioni, consultare il rivenditore o gli enti locali incaricati della gestione dei rifiuti.

Cz **Symbol pro oddělený sběr odpadu platný v evropských zemích**

Tento symbol znamená, že tento produkt se má odkládat odděleně. Následující pokyny platí pro uživatele z evropských zemí.

- Tento produkt se má odkládat na místě sběru k tomuto účelu určeném. Neodhazujte spolu s domácími odpady.
- Více informací o způsobu zacházení s nebezpečným odpadem vám podá příslušná místní instituce.

15

This symbol is provided for use in the People's Republic of China, for environmental protection in the fields of electronic information products.

このマークは、中国のお客様に向けたもので、電子情報製品分野における環境保護を目的としています。

jp **ヨーロッパにおける廃棄物個別回収のシンボルマーク**

このシンボルマークは本製品が個別に回収されなければならないことを示しています。

次項は本製品をヨーロッパ（EU）で使用する場合にのみ適用されます。

- 本製品は指定された収集場所で個別に回収されるように定められています。家庭ゴミとして廃棄しないでください。
- 詳細については販売代理店または地域の廃棄物処理機関にご連絡ください。

住所 / ADDRESS

産業機器 / Industrial Instruments

株式会社ニコン
〒100-8331
東京都千代田区有楽町 1-12-1 新有楽町ビル
インストルメンツカンパニー 営業統括部 営業部 産業機器営業課
電話: (03) 3216-2384
インストルメンツカンパニー 営業統括部 営業戦略部 産業機器課
電話: (03) 3216-2371

株式会社ニコンインステック
本 社
〒100-0006
東京都千代田区有楽町 1-12-1 (新有楽町ビル 4F)
電話: (03) 3216-9163 (バイオサイエンス)
電話: (03) 3216-9171 (産業機器)

札幌営業所
〒060-0051
札幌市中央区南 1 条東 2-8-2 (SR ビル 8F)
電話: (011) 281-2535 (バイオサイエンス・産業機器)

名古屋営業所
〒465-0093
名古屋市名東区一社 3-86 (クエストビル 2F)
電話: (052) 709-6851 (バイオサイエンス・産業機器)

関西支店
〒532-0003
大阪市淀川区宮原 3-3-31 (上村ニッセイビル)
電話: (06) 6394-8801 (バイオサイエンス)
電話: (06) 6394-8802 (産業機器)

九州支店
〒913-0034
福岡市東区多の津 1-4-1
電話: (092) 611-1111 (バイオサイエンス・産業機器)

NIKON INSTRUMENTS INC.
1300 Walt Whitman Road, Melville, N.Y. 11747-3064, U.S.A.
tel. +1-631-547-8500

NIKON INSTRUMENTS EUROPE B.V.
Laan van Kronenburg 2, 1183 AS Amstelveen, The Netherlands
tel. +31-20-44-96-300

NIKON INSTRUMENTS(SHANGHAI)CO.,LTD.
tel. +86-21-6841-2050

NIKON SINGAPORE PTE LTD
tel. +65-6559-3618

NIKON MALAYSIA SDN BHD
tel. +60-3-7809-3688

NIKON INSTRUMENTS KOREA CO.,LTD.
tel. +82-2-2186-8410

NIKON INDIA PRIVATE LIMITED
tel. +91-124-4688500

NIKON CANADA INC.
tel. +1-905 602 9676

NIKON FRANCE S.A.S.
tel. +33-1-4516-45-16

NIKON GMBH
tel. +49-211-941-42-20

NIKON INSTRUMENTS S.p.A.
tel. +39-055-300-96-01

NIKON AG
tel. +41-43 277-28-67

NIKON UK LTD.
tel. +44-208-247-1717

NIKON GMBH AUSTRIA
tel. +43-1-972-6111-00

NIKON BELUX
tel. +32-2-705-56-65

NIKON METROLOGY, INC.
12701 Grand River Avenue, Brighton, MI 48116 U.S.A.
tel. +1-810-220-4360
sales_us@nikonmetrology.com

NIKON METROLOGY EUROPE NV
Geldemaaksebaan 329, 3001 Leuven, Belgium
tel. +32-16-74-01-00
sales_europe@nikonmetrology.com

NIKON METROLOGY GMBH
tel. +49-6023-91733-0
sales_germany@nikonmetrology.com

NIKON METROLOGY SARL
tel. +33-1-60-86-09-76
sales_france@nikonmetrology.com

NIKON METROLOGY UK LTD.
tel. +44-1332-811-349
sales_uk@nikonmetrology.com

バイオサイエンス / Bio Science

株式会社ニコン
〒100-8331
東京都千代田区有楽町 1-12-1 新有楽町ビル
インストルメンツカンパニー 営業統括部 営業部 バイオサイエンス営業課
電話: (03) 3216-2375
インストルメンツカンパニー 営業統括部 営業戦略部 バイオサイエンス課
電話: (03) 3216-2360

株式会社ニコンインステック
本 社
〒100-0006
東京都千代田区有楽町 1-12-1 (新有楽町ビル 4F)
電話: (03) 3216-9163 (バイオサイエンス)

札幌営業所
〒060-0051
札幌市中央区南 1 条東 2-8-2 (SR ビル 8F)
電話: (011) 281-2535 (バイオサイエンス・産業機器)

名古屋営業所
〒465-0093
名古屋市名東区一社 3-86 (クエストビル 2F)
電話: (052) 709-6851 (バイオサイエンス・産業機器)

関西支店
〒532-0003
大阪市淀川区宮原 3-3-31 (上村ニッセイビル)
電話: (06) 6394-8801 (バイオサイエンス)

九州支店
〒913-0034
福岡市東区多の津 1-4-1
電話: (092) 611-1111 (バイオサイエンス・産業機器)

NIKON INSTRUMENTS INC.
1300 Walt Whitman Road, Melville, N.Y. 11747-3064, U.S.A.
tel. +1-631-547-8500

NIKON INSTRUMENTS EUROPE B.V.
Laan van Kronenburg 2, 1183 AS Amstelveen, The Netherlands
tel. +31-20-44-96-300

NIKON INSTRUMENTS(SHANGHAI)CO.,LTD.
tel. +86-21-6841-2050

NIKON SINGAPORE PTE LTD
tel. +65-6559-3618

NIKON MALAYSIA SDN BHD
tel. +60-3-7809-3688

NIKON INSTRUMENTS KOREA CO.,LTD.
tel. +82-2-2186-8410

NIKON INDIA PRIVATE LIMITED
tel. +91-124-4688500

NIKON CANADA INC.
tel. +1-905 602 9676

NIKON FRANCE S.A.S.
tel. +33-1-4516-45-16

NIKON GMBH
tel. +49-211-941-42-20

NIKON INSTRUMENTS S.p.A.
tel. +39-055-300-96-01

NIKON AG
tel. +41-43 277-28-67

NIKON UK LTD.
tel. +44-208-247-1717

NIKON GMBH AUSTRIA
tel. +43-1-972-6111-00

NIKON BELUX
tel. +32-2-705-56-65