

Motic[®]

**Polarizing Microscope
BA310 Pol
Instructions Manual**

WWW.MOTIC.COM

MOTIC INCORPORATION LTD.

We are constantly endeavouring to improve our instruments and to adapt them to the requirements of modern research techniques and testing methods. This involves modification to the mechanical structure and optical design of our instruments.

Therefore, all descriptions and illustrations in this instruction manual, including all specifications are subject to change without notice.

Although every effort has been made to ensure the accuracy of this instruction manual, if you note any points that are unclear or inaccurate, please contact Motic agency or our Technical Service directly.

Introduction

Polarizing microscopes are used in the study of thin sections of minerals and rocks as well as other anisotropic materials (fibers, plastics, etc.). The optical system is similar to that of modern compound microscopes.

The most distinctive features of a polarizing microscope are the rotatable stage, polarizer and analyzer, Bertrand lens system as well as mica plate, gypsum plate and quartz wedge. This special equipment allows the evaluation of properties and characteristics of materials that cannot be measured by other microscope methods.

Table of contents

1. Nomenclature	5
2. Setting Up The Instrument	9
3. Assembling the microscope	10
3.1 Verifying input voltage	10
3.2 Halogen lamp	11
3.3 Specimen clip	11
3.4 Attachable mechanical stage (optional)	11
3.5 Objectives	11
3.6 Condenser	11
3.7 Intermediate tube	12
3.8 Analyser slider	12
3.9 Compensators	12
3.10 Eyepiece tube	12
3.11 Eyepieces	12
3.12 Filters	13
3.13 Power cord	13
4. Microscopy	14
Manipulation of each component	
4.1 Coarse and fine focusing	14
A. Coarse focus torque adjustment	14
B. Coarse focus lock	14
4.2 Stage upper limit stop adjustment	15
4.3 Beam split slider	15
4.4 Interpupillary distance adjustment	15
4.5 Diopter adjustment	16
4.6 Centering the condenser	16
4.7 Use of aperture diaphragm	17
4.8 Use of field diaphragm	17
4.9 Brightness and contrast adjustment	18
4.10 Orientation of polarizer and analyzer	18
4.11 Focusing and centering the bertrand lens	19

4.12 Compensators	20
A. $1/4\lambda$ -plate	20
B. 1λ -plate	20
C. Quartz Wedge	20
4.13 Centering the Objectives	21
5. Photomicrographic procedure	22
6. Terminology	23
7. Troubleshooting table	25
8. Care and maintenance	27
9. Warning labels	29

1. Nomenclature

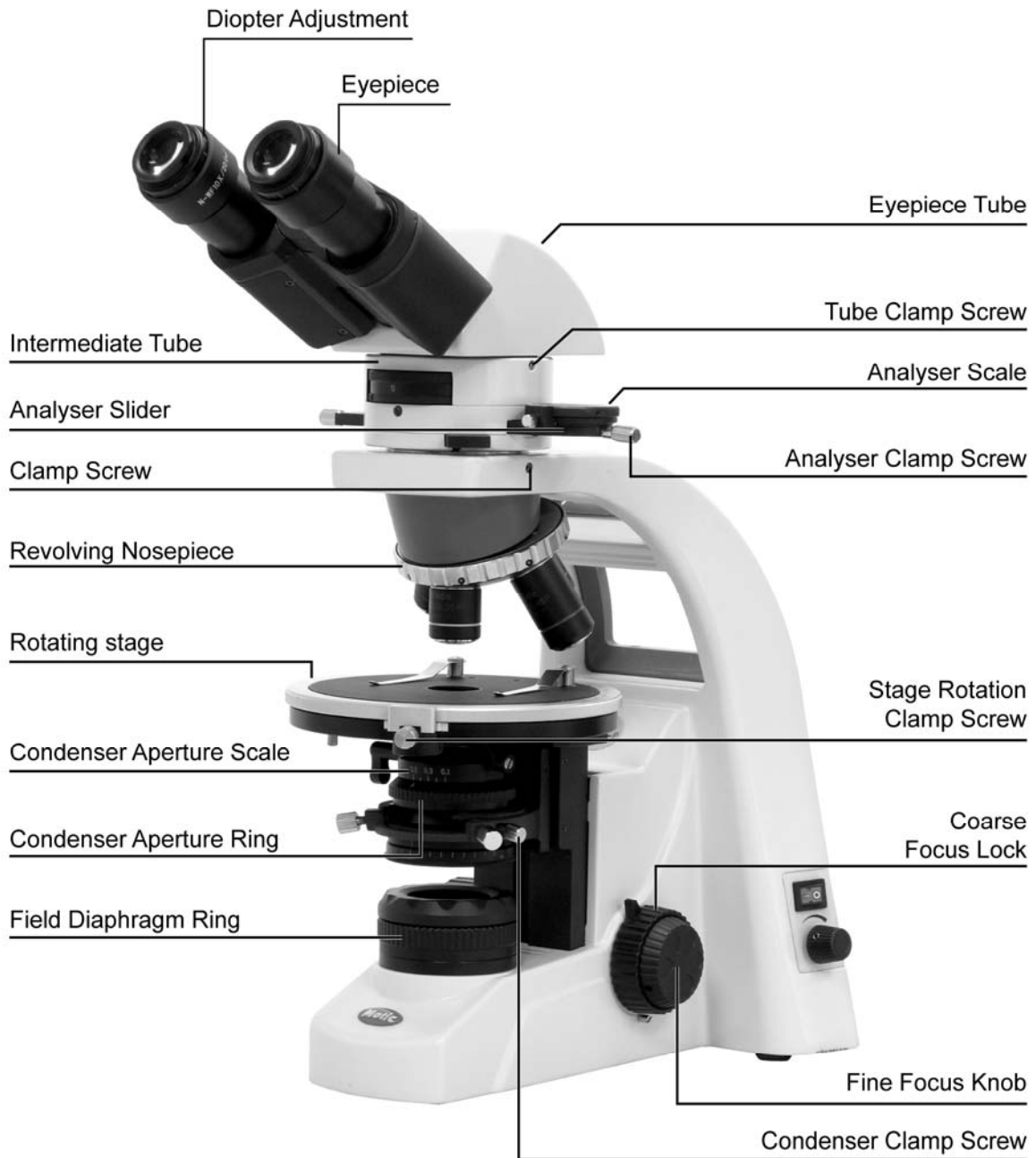

BA310 Pol

Bertrand Lens
Centering Screw

Compensator Slot

Compensator

Analyser Scale



Intermediate tube

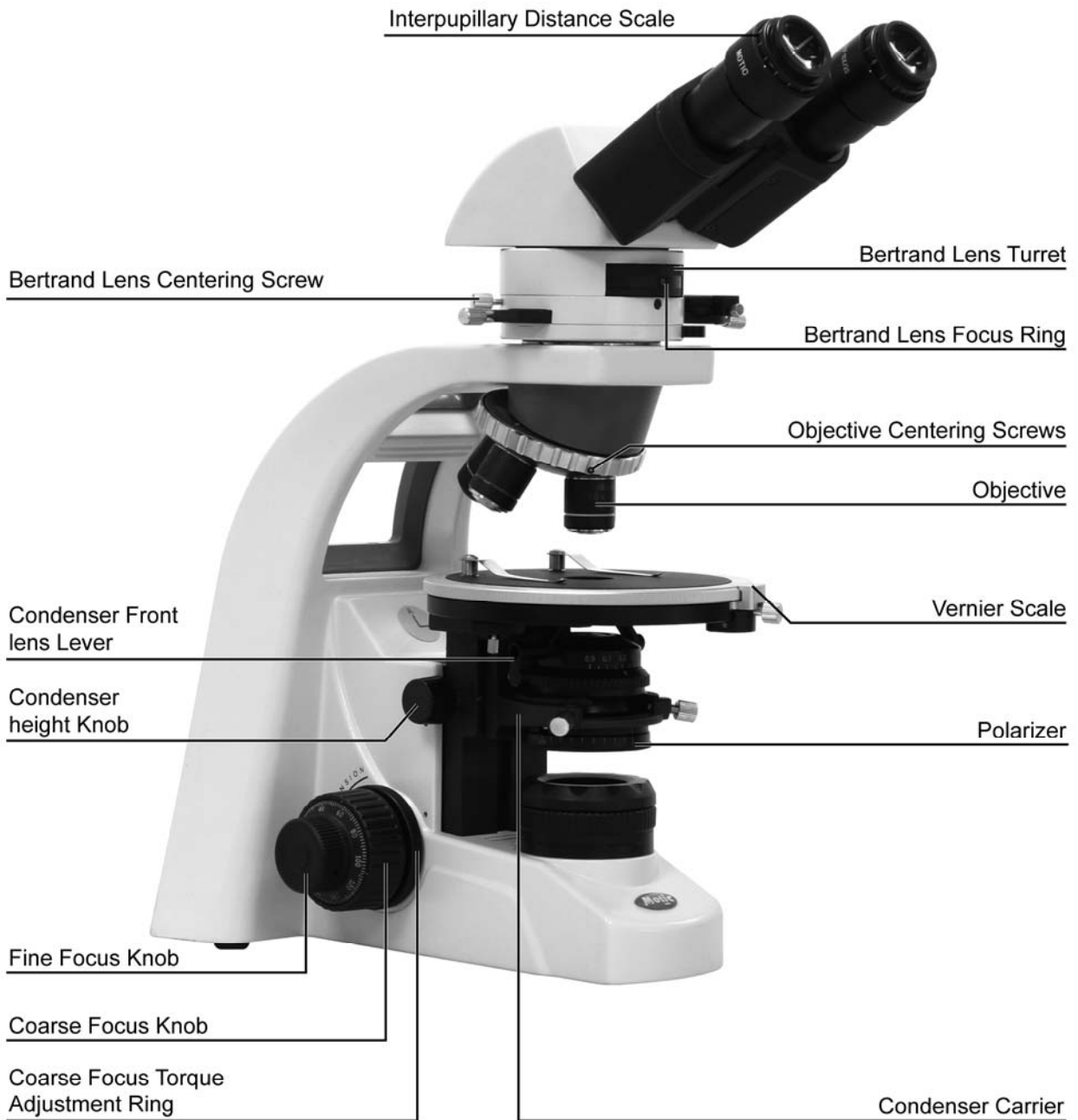

BA310Pol

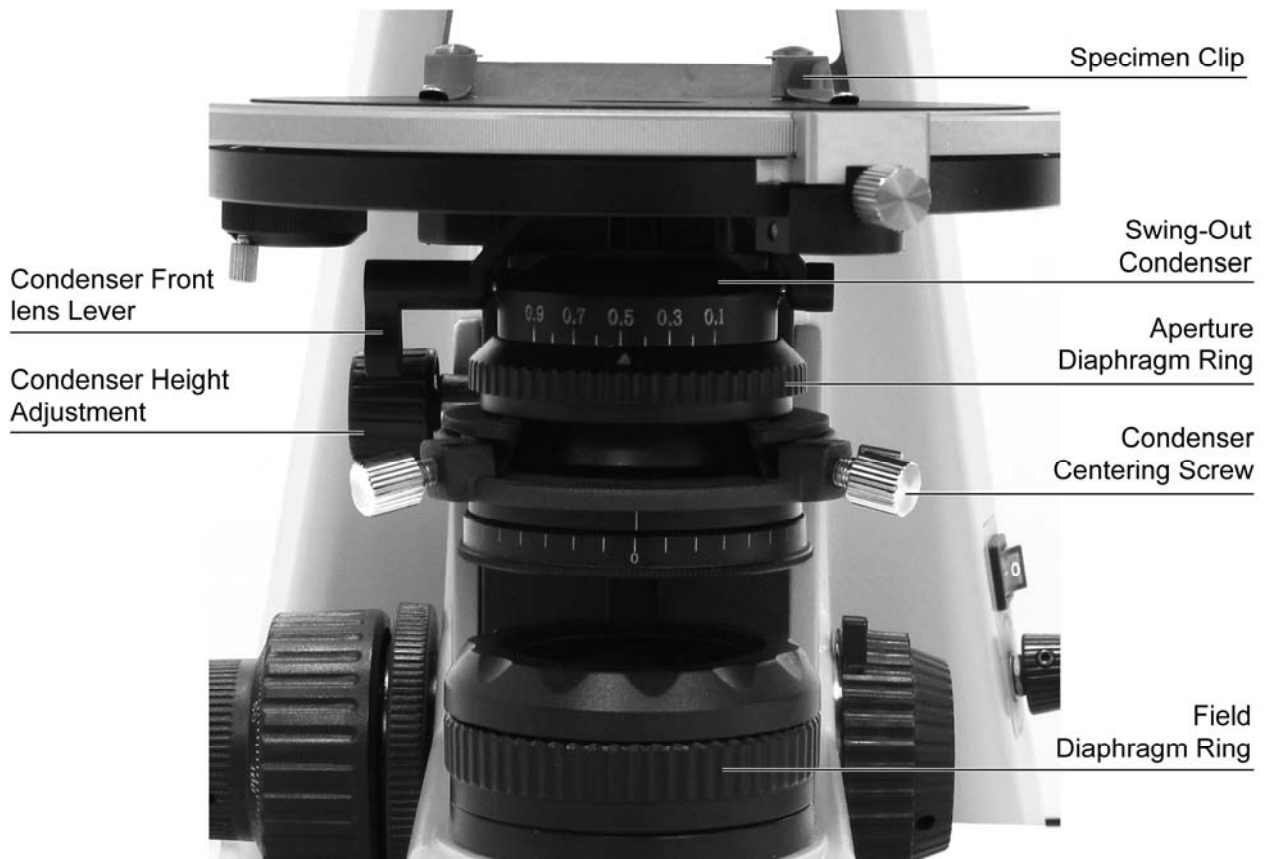

2. Setting up the Instrument

Avoid placing the instrument in locations exposed to direct sunlight, dust, vibration, high temperature, high humidity and where it is difficult to unplug the power supply cord.

Operating environment

- Indoor use
- Altitude: Max 2000 meters
- Ambient temperature: 15°C to 35°C
- Maximum relative humidity: 75% for temperature up to 31°C decreasing linearly to 50% relative humidity at 40°C
- Supply voltage fluctuations: Not to exceed $\pm 10\%$ of the normal voltage
- Pollution degree: 2 (in according with IEC60664)
- Installation / Overvoltage category: 2 (in according with IEC60664)
- Air Pressure of 75kPa to 106kPa
- Avoid frost, dew, percolating water, and rain

3. Assembling the microscope



3.1 Verifying input voltage

- The automatic voltage selection works with a broad range of settings. However, always use a power cord that is rated for the voltage used in your area and that has been approved to meet local safety standards. Using the wrong power cord could cause fire or equipment damage.
- When using an extension cord, only use a power supply cord with a protective earth (PE) wire.
- In order to prevent electric shock, always turn the switch on the power supply **off** before connecting the power cord.

- Electrical Specifications:

Halogen

Input: 90-240V~, 80VA, 50-60Hz

Lamp: 6V --- 30W Halogen

Fuse: 250V T2.5A (If the original fuse is blown, please replace with specified fuse)

3.2 Halogen lamp

- Tungsten-halogen lamps operate at very high temperatures and may cause serious burn injuries if handled while hot.
- When replacing these lamps, always allow them to cool down before removing them from the lamp socket.
- Avoid handling the bulb directly because fingerprints will be burned into the glass, often initiating premature lamp failure.
- The Halogen lamp bulb comes packed in protective plastic bags to avoid handling problems.
- Use a pair of scissors to cut the bag near the tungsten pins, insert the lamp into its holder while it still remains in the bag.
- Remove the bag, when the lamp is properly positioned in the lamp socket.

3.3 Specimen clip

- Insert two specimen clips into the holes on the circular graduated stage surface.

3.4 Attachable mechanical stage (optional)

- Mount the attachable mechanical stage onto the rotating stage, while inserting the two positioning pins of the mechanical stage into the holes of the stage surface.
- Tighten the clamp screws.

3.5 Objectives

- Lower the stage completely.
- Screw the objectives into the revolving nosepiece starting with the reference position (without centering option) so that a clockwise rotation of the nosepiece brings the next higher magnification objective into position.

Note: The BA310 Polarizing microscope allows you to center three objective positions in relation to the reference objective position.

3.6 Condenser

- Raise the stage by turning the coarse focus knob clockwise.
- Lower the condenser carrier by turning the condenser focus knob anti-clockwise.
- Insert the condenser in the dovetail mount with aperture scale facing the front.
- Secure the condenser with the clamp screw.
- Turn the condenser focus knob to raise the condenser as far as it will go.

3.7 Intermediate tube

- To mount the intermediate tube, start loosening the intermediate tube clamp screw on the microscope arm.
- Insert the intermediate tube into the round dovetail mount on the microscope arm.
- The orientation pin on the lower side of the intermediate tube has to fit to the receiving groove on the microscope arm.
- Secure in position with the clamp screw.

A built-in depolarizer unit inside the intermediate tube provides equalized colours in the eyepiece tube and the photo port. (See Microscope Terminology)

3.8 Analyser slider

- Unscrew the analyser slider knob located on the side of the slider.
- Insert the slider into the slot of the intermediate tube with the analyser scale positioned on the right hand side.
- Secure the slider by relocating the slider knob in the related thread hole.

3.9 Compensators

- Compensators will be inserted into the compensator slot of the intermediate tube.
- The compensator slot is oriented at 45° to the cross-lines of the eyepiece.

3.10 Eyepiece tube

- Loosen the eyepiece tube clamp screw. Insert the eyepiece tube on the dovetail mount on top of the intermediate tube.
- Make sure the location pin on the lower side of the eyepiece tube matches the pin groove of the intermediate tube.
- Secure the eyepiece tube in position with the clamp screw.

3.11 Eyepieces

- Place the eyepieces into the sleeves of the binocular eyepiece tube with a slightly turning move.
- The sleeve of the right eyepiece tube has positioning slots for either 90° and 45° orientation
- Install the correct eyepiece by aligning the positioning pin of the eyepiece with positioning slot of the eyepiece sleeve.
- Slide the rubber eyecups onto each eyepiece.

3.12 Filters

- Place the chosen filter in the filter holder located above the field lens by removing the filter holder ring. Avoid polluting filter and lens surfaces with dust, dirt or finger prints.

Filter options:

Filter	Function
ND2 (Transmission=50%)	For brightness adjustment in photomicrography
ND4 (T=25%)	
ND16 (T=6.25%)	
Blue Filter (Colour Balancing Filter)	For routine microscopy and photomicrography
Green Interference (546nm)	For retardation measurement and contrast adjustment

3.13 Power cord

- Connect the socket of the of the power cord to the AC inlet on the rear of the microscope. Plug in the other end of the cord to an AC outlet with ground conductor.

4. Microscopy

Manipulation of each component

4.1 Coarse and fine focusing

- Focusing is carried out with the coarse and fine focus knobs at the left and right side of the microscope stand.
- The direction of vertical movement of the stage corresponds to the turning direction of the focus knobs.
- One complete rotation of the fine focus knob moves the stage 0.2mm. The graduation on the fine focus knob is 2 microns.

Never attempt either of the following actions, since doing so will damage the focusing mechanism:
Rotate the left or right knob while holding the other.
Turning the coarse and fine focus knobs further than their limit.

A. Coarse focus torque adjustment

- To increase the torque, turn the torque adjustment ring located behind the left-hand coarse focus knob in the direction indicated by the arrow. To reduce the torque, turn the ring in the opposite direction.

B. Coarse focus knob lock

- The coarse focus knob lock (on right side of microscope) can fix the upper stage position at any height.
- With the specimen in focus, turn the handle to fix the knob.
- When the coarse focus knob lock is in position, the stage cannot be raised from that position.

4.2 Stage upper limit stop adjustment:

(The upper Stage Limit is preset at the factory; please only adjust if necessary)

- The Stage Upper Limit stop marks the uppermost stage position. This is to prevent damage of the objectives while focussing. If the correct preset has been changed accidentally during transport, please perform the following procedure:
 - Loosen the Stage upper Limit Stop.
 - Focus the specimen carefully.
 - Fix the Stage upper Limit Stop.
- When the stage upper limit stop is in position, the Stage cannot be raised above that position. However, the fine focus knob can be moved without raising the stage.



4.3 Beam split slider

- The beam split slider of the trinocular eyepiece tube can be used to select the light distribution between the eyepiece tube and the vertical phototube.
- When the slider is pushed in, 100% of the light enters the eyepieces. When the prism slider is pulled out, 100% of light will enter the phototube.

4.4 Interpupillary distance adjustment

- Before adjusting the interpupillary distance, bring a specimen into focus using the 10x objective.
- Adjust the interpupillary distance so that both the right and left field of view become one.
- This adjustment will enable the user to observe the specimen with both eyes.

4.5 Diopter adjustment

- Every human eye is different, so only the adjustment of the eyepieces will bring the microscope to its best performance.
- Set the diopter on both eyepieces to the “0” position.
- Change to 10x magnification and focus the image of the specimen with one eye only.
- Use the eye which is most convenient for first focussing.
- When the best focus position is reached, close this eye and use the other eye for the following steps.
- Correct the focus for the second eye by using only the Diopter Ring, do not use the coarse / fine focusing knob!
- Change to a higher magnification to verify the result and if necessary repeat the procedure. Higher magnification objectives do have a smaller depth of focus, so the adjustment will be more precise.
- Keep this final diopter position for all magnification / lenses. The diopter position for each user can be read from the scale, so it can easily be reset.

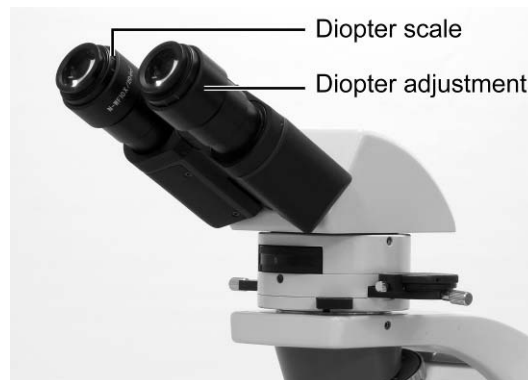

4.6 Centering the condenser

- Fully open the field of view diaphragm and condenser aperture diaphragm.
- Set the specimen on the stage with the cover glass facing up.
- Bring the specimen image into focus, using the 10X objective.
- Switch in the condenser head.
- Close the field diaphragm by 50%.
- Turn the condenser focus knob to bring the field diaphragm image into focus of the specimen plane. The border of the light spot should be as sharp as possible.
- By using the condenser centering screws, bring the light spot into the middle of the field.
- For each objective this procedure should be repeated. Finally open the field diaphragm so that it is just outside the field of view.

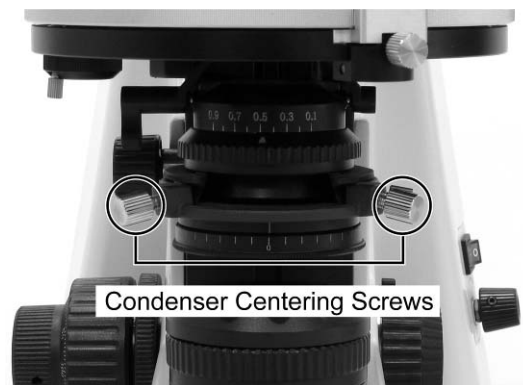

4.7 Use of aperture diaphragm

- The condenser aperture diaphragm is provided for adjusting the numerical aperture (N.A.) of the illumination system of the microscope. It determines the resolution of the image, contrast, depth of focus and brightness.
- Stopping down will lower the resolution and brightness but increase the contrast and depth of focus.
- An image with appropriate contrast in most cases can be obtained with an aperture diaphragm closed down to $\frac{2}{3}$ of the maximum value.
- To get this aperture diaphragm position:
 - adjust the condenser aperture diaphragm ring referring to the condenser aperture scale, or
 - by observing the diaphragm image visible on the exit pupil inside the eyepiece tube (the eyepiece has to be removed for that), or
 - by using a centering telescope after removing one of the eyepieces and focusing on the aperture diaphragm.
- When swinging-out the top lens of the condenser for low magnification objectives, open the condenser aperture diaphragm completely.

4.8 Use of field diaphragm

- The field diaphragm determines the illuminated area on the specimen. Turning the field diaphragm ring changes the size of the field diaphragm. For normal observation, the diaphragm is set slightly larger than the field of view. If a larger than required area is illuminated, stray light will enter the field of view. This will create a flare in the image and lower the contrast.
- The thickness of the glass slide must be 1mm, otherwise the field diaphragm may not be focused on the specimen plane.
- When the condenser top lens is swung out of the optical path, fully open the field diaphragm, as the N.A. of the illuminating system will be reduced if the diaphragm is excessively stopped down.

4.9 Brightness and contrast adjustment

- Neutral density filters are used for brightness adjustment in routine microscopy and photomicrography without affecting the colour temperature.
- The Green interference filter (546nm) is used in combination with the quartz wedge.

4.10 Orientation of polarizer and analyzer

- Push in the brightfield position of the analyzer slider
- Focus on the specimen.
- Take the specimen out of the optical path.
- Bring the analyzer into the optical path.
- Set the analyser to the “0” position by loosening the analyzer clamp screw and rotating the analyser dial (the rotation angle of the analyser can be read in the range between 0° to 360° in increments of 0.1° by the Vernier scale).

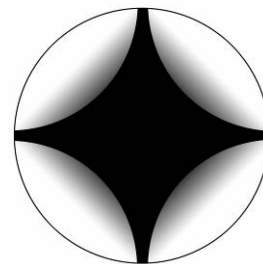
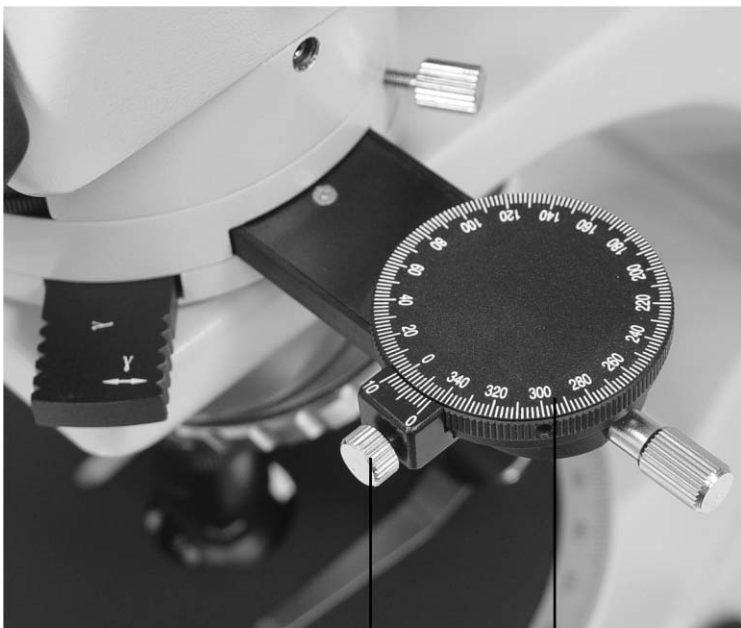

Dark cross image is formed on the exit pupil of the objective

Analysers rotating dial

Analyzer clamp screw

- Rotate the Bertrand lens turret to “B” position and bring the Bertrand lens in the optical path to enable the exit pupil of the objective to be seen through the eyepiece. Rotate the polarizer so that a dark cross image is formed on the exit pupil as shown in the figure above.

4.11 Focusing and centering the Bertrand lens

- Rotate the Bertrand lens turret to “B” position and bring the Bertrand lens in the optical path.
- Bring 40x Objective into optical path.
- Use the Bertrand lens focus ring under the Bertrand lens turret to focus on the image of the condenser aperture diaphragm that is stopped down to 70 – 80% of the numerical aperture of the objective.
- Use the Bertrand lens centering screws to bring the image of the condenser aperture to the center of the field of view.
- The centering procedure is the same as that for the condenser except that the condenser aperture diaphragm image is used instead of the field diaphragm image.

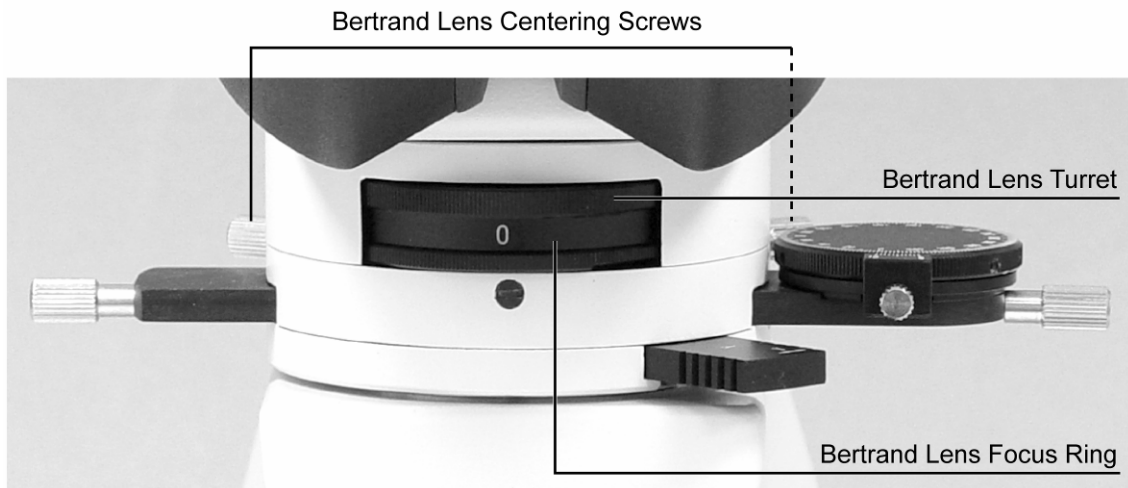

4.12 Compensators

- All polarizing microscopes are equipped with a compensator in the optical beam path between polarizer and analyzer.
 - Compensators are sections of optically anisotropic material which, when inserted in the microscope between crossed polarizers, produce a defined optical path difference of mutually perpendicular plane-polarized light waves.
- A. $1/4\lambda$ -plate** - The $1/4\lambda$ -plate is also called mica plate and has an optical path difference around 140nm (yellow light has $\lambda = 580\text{nm}$, therefore $1/4\lambda = 580/4 = 145\text{nm}$).
- B. 1λ -plate (sensitive tint or first-order red)** - The 1λ -plate is a gypsum plate of a thickness to give 1λ optical path difference for green light of 550 nm. This wavelength is therefore extinguished with the resulting interference colour having the typical tint of the first-order red/violet. This magenta colour is sometimes named 'sensitive tint'.
- C. Quartz Wedge** – This device has a range of 4 orders and is commonly employed for qualitative retardation measurements of petrographic specimens or other birefringent materials whose retardation value falls within the wedge limit.

Measuring Retardation from 1λ to 4λ

- **Observing extinction position**
 - Observe the position where the part of the specimen to be measured becomes darkest by rotating the stage under crossed polars.
- **Observing subtraction position**
 - Rotate the stage 45° to the diagonal position; here the specimen appears to be at it's brightest. Insert the appropriate compensator into the slot; verify the interference colour of the part to be measured. Rotate the stage another 90° to get the associated colour. With those 2 observed colours, the +/- position of the sample can be determined.

- **Measuring retardation**

- Slide the quartz wedge along the length of the slot, and the interference colour will change.
- Stop sliding the quartz wedge where the dark band covers the part of the specimen to be measured. Remove the specimen and compare the interference colour (at the same position without the specimen) with the Interference Colour Chart to ascertain the amount of retardation.
- Measuring the retardation or ascertaining by interference colour should be done with field of view diaphragm stopped down to the part to be measured.

Note: With monochromatic light the coloured fringes are seen as alternating dark and bright bands.

4.13 Centering the objective

- The BA310 Polarizing microscope allows for centering of three objectives in relation to a reference objective.
- Before centering the objectives, look through the binocular tube at the field of view, pick out an easily recognizable target and move the target in the middle to the cross line by moving the sample.
- Rotate the stage
- The target now rotates in a circle while touching at one point the intersection of the cross lines. Rotate the stage until the target is farthest away from the intersection. By means of the centering screws bring it half way to the intersection point. Move the target again to the intersection point by moving the slide. Repeat the procedure until the target rotates on the intersection point.

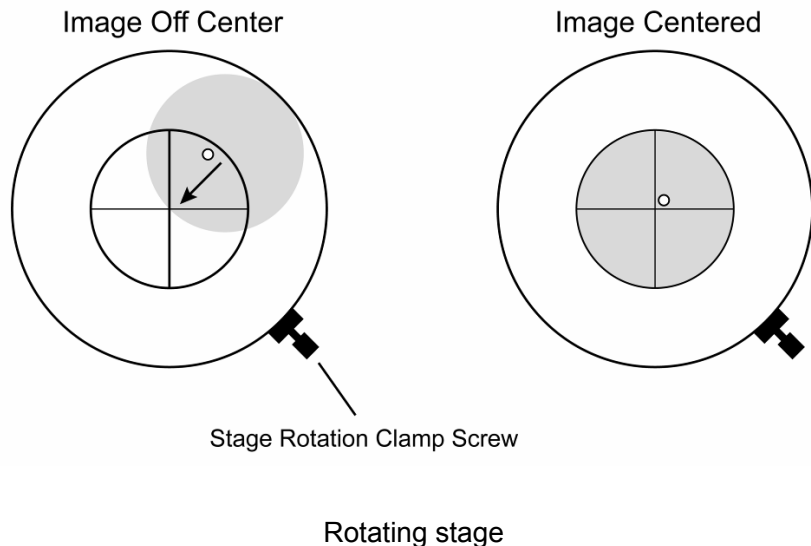

5. Photomicrographic Procedure

- To ensure vibration free operation, set the microscope on a sturdy vibration free table or a bench with a vibration proof device.
- Pull the beam split lever of the trinocular eyepiece tube all the way out to the limit, the ratio of light entering the phototube will be 100%
- To ensure optimal illumination, check the position and centering of the lamp and position of the condenser.
- Select a blue filter for routine application.
- Adjustment of the field diaphragm is important for the purpose of limiting extraneous light that may cause flare and lower the contrast. Stop down the diaphragm to achieve an illuminated area slightly larger than that of the field of view.
- A change to depth of focus, contrast and resolution of the image is attainable with an aperture setting that is $\frac{2}{3}$ of the objective N.A.
- For photomicrographic procedures, refer to the manual of the specific camera being used.

Note: The correlation between the position of the polarizing plate and photomicrographic devices should not be of any concern to the user, given that the intermediate tube contains a built-in depolarizer.

6. Terminology

Aperture, Numerical (N.A.)

The numerical aperture is an important factor determining the resolution power of the condenser and objective. It is calculated by the formula:

(N.A. = $n \sin \alpha$), where n is the refractive index of a medium (air, water, immersion oil etc.) between the objective and the specimen, and α is half of the maximum angle at which light enters the lens from a focused object point on the optical axis.

Anisotropic

Quality of a transparent material having different refractive indices depending on the vibration direction of the transmitted light.

Axis - Optical

A straight line joining the centers of curvature of lens surfaces.

Bertrand Lens

An intermediate lens, which transfers an image of the back focal plane of the objective into the primary image plane. Mostly used for conoscopic observation in polarized light microscopy.

Cover Glass Thickness

Transmitted light objectives are designed to image specimens that are covered by a thin cover glass (cover slip). The thickness of these small glass pieces is now standardized at 0.17 mm for most applications.

Diaphragm, Condenser

A diaphragm, which controls the effective size of the condenser opening angle and thus the illumination aperture.

Diopter Adjustment

The adjustment of the eyepiece of an instrument to provide accommodation for the eyesight differences of individual observers.

Epi-Illumination

Illumination is accomplished by means of a vertical illuminator placed above the objective.

Focusing Eyepiece

An eyepiece with a device for focusing a graticule mounted within it and coinciding with the primary image plane.

Michel Levy Scale

Colour chart-plotting thickness of the anisotropic specimen, its birefringence ($n_1 - n_2$) and its retardation in nanometers. Any one of the three variables can be determined if the other two are known.

Micrometer: μm

A metric unit of length measurement = 1×10^{-6} meters or 0.000001 meters

<p>Conoscopic Observation The study of the back focal plane of the objective is called conoscopic as the observations are associated with the cone of light furnished by the condenser and viewed by the objective. This study is accomplished by inserting a Bertrand lens or by using a phase telescope.</p> <p>Crossed Polars The condition in which the vibration directions of polarizers and analysers are mutually perpendicular.</p> <p>Depolarizer Depolarizers change plane polarization into a mix of polarization states, which resemble un-polarized light.</p> <p>Nanometer: nm A metric unit of length measurement= 1×10^{-9} meters or 0.000000001 meter.</p>	<p>Orthoscopic Observation This is the normal way of viewing an object through a microscope. With Koehler illumination, the image of the field diaphragm is projected by the condenser into the specimen plane.</p> <p>Stage Micrometer The graduated scale used as a standard on the stage of a light microscope for calibrating an eyepiece micrometer.</p> <p>x-axis In a plane Cartesian coordinate system, the horizontal axis, or axis in the left to right direction.</p> <p>y-axis In a plane Cartesian coordinate system, the vertical axis orthogonal to the x-axis.</p>
---	--

7. Troubleshooting Table

As you use your microscope, you may occasionally experience a problem.

The troubleshooting table below contains the majority of frequently encountered problems and the possible causes.

Problem	Possible Cause
Vignetting or uneven brightness in the field of view or field of view only partially visible	Analyser slider in intermediate position
	Compensator slider in midway position
	Bertrand lens in optical path
	Condenser not mounted correctly
	Condenser is not centered
	Condenser is set too low
	Condenser top lens not fully swung in or out
	Field diaphragm closed too far
	Aperture diaphragm closed too far
	Revolving nosepiece not clicked into position
	Trinocular eyepiece tube beam splitter lever in intermediate position
Dust or dirt in the field of view	Aperture diaphragm closed too far
	Condenser is set too low
	Dust or dirt on specimen surface
	Dust or dirt on field lens, filter
Poor image (low contrast or resolution) Uneven focus	Condenser is set too low
	Aperture diaphragm closed too far
	No cover glass
	Too thick or thin cover glass
	Immersion oil not used on immersion procedure
	Air bubbles in immersion oil
	Specified immersion oil used not used
	Immersion oil on dry objective
	Greasy residue on eye lens
	Incorrect illumination
	Specimen holder not fixed securely on stage
Specimen not secured in position	

Image tinged yellow	Lamp voltage is set too low
	Blue filter is not in
Focusing is not possible with high magnification objectives	Slide is upside down
	Cover glass is too thick
High magnification objectives strike the specimen when changing over from low to high magnification	Slide is upside down
	Cover glass is too thick
	Eyepiece diopter not adjusted
No cohesion of binocular image	Magnification or field of view of left and right eyepieces differ
	Interpupillary distance not adjusted
	Eyepiece diopter not adjusted
Eye strain or fatigue	Interpupillary distance not adjusted
	Diopter adjustment not made
	Field of view of left and right eyepiece differ
	Inadequate illumination

Electrical

Problem	Possible Cause
Lamp does not light	Power supply not plugged in
	Lamp not installed
	Lamp burnt out
Inadequate brightness	Specified lamp not being used
Lamp blows out immediately	Specified lamp not being used
Lamp flickers	Connectors are not securely connected
	Lamp near end of service life
	Lamp not securely plugged into socket

8. Care and Maintenance

A. Do not disassemble

1. Disassembly may significantly affect the performance of the instrument, and may result in electric shock or injury and will void the terms of the warranty.
2. Never attempt to dismantle any parts other than described in this manual. If you notice any malfunction, contact your nearest Motic representative.

B. Cleaning the microscope

- Do not use organic solvents such as ether; alcohol or paint thinner on painted surfaces or plastic components. Doing so could result in discolouration of painted or plastic surfaces.
- When cleaning lenses do not use any solvents other than absolute alcohol as, they may damage lens bonding cement.
- Do not use petroleum benzene when cleaning components such as filters or lenses.
- Absolute alcohol and petroleum benzene are highly flammable. Keep away from open flames and when turning the power switch on or off.
- For stubborn dirt, dampen a piece of gauze with diluted neutral detergent and wipe lightly.

C. Disinfecting the microscope

- Follow the standard procedures for your laboratory.

D. When not in use

- When not in use, cover the instrument with vinyl dust cover and store in a place low in humidity where mould is not likely to form.
- Store the objectives, eyepieces and filters in a container or desiccator with drying agent.
- Proper handling of the microscope will ensure years of trouble free service.
- If repair become necessary, please contact your Motic agency or our Technical Service direct.

Note:

- If equipment is used in a manner not specified by the manufacturer, the protection provided by the equipment may be impaired.
- To avoid getting wet, do not use the microscope near water.

E. Bulb replacement



The bulb and the lamphouse become very hot during and after a period of operation.





Risk of burn – Do not touch the bulb during or immediately after period of operation.

Make sure the bulb has cooled sufficiently before attempting to replace the bulb.

- The applicable halogen bulbs are the 6V 30HAL high-intensity bulb
- In order to prevent electric shock always turn the power switch off and unplug the power cord before installing or replacing the bulb.
- Place the microscope on its back and pull back the lamp cover plate.
- Firmly insert the bulb into the socket pinholes until it reaches the limit. Be careful not to tilt the bulb when mounting.
- When installing the bulb, do not touch the glass surface of the bulb with bare fingers. Doing so will cause fingerprints, grease, etc., to burn onto the bulb surface, reducing the illumination provided by the bulb. If the surface is contaminated, wipe it clean using lens tissue.
- Close lamp cover plate and secure until it snaps into position.

9. Warning labels

The following warning labels (or symbols) are found on the microscope, study the meaning of the warning labels (or symbols) and always use the equipment in the safest possible manner.

Warning Label / Symbol	Explanation
	Indicates that the surface becomes hot, and should not be touched with bare hands.
	Indicates that the main switch is ON.
	Indicates that the main switch is OFF.
	Indicates alternating current.
	CAUTION! Risk of danger. Please consult documentation in all cases where this symbol is used.

The lamp and the lamphouse become very hot during and after a period of operation.

Risk of burn – Do not touch the lamp during or immediately after period of operation.

Make sure the lamp has cooled sufficiently before attempting to replace the lamp.

Don't pick up from the bottom during equipment operation.

Proper handling of the microscope will ensure years of trouble free service.

If repair become necessary, please contact your Motic agency or our Technical Service directly.

Motic®

NO.: 1300901106681

Motic Incorporation Ltd. (Hong Kong)

Rm 2907-8, Windsor House, 311 Gloucester Road, Causeway Bay, Hong Kong Tel: 852-2837 0888 Fax: 852-2882 2792

Motic Instruments Inc. (Canada)

130-4611 Viking Way, Richmond, B.C., V6V 2K9, Canada Tel: 1-877-977 4717 Fax: 1-604-303 9043

Motic Deutschland GmbH (Germany)

Christian-Kremp-Strasse 11, D-35578 Wetzlar, Germany Tel: 49-6441-210 010 Fax: 49-6441-210 0122

Motic Spain, S.L. (Spain)

Poligon Industrial Les Corts, Camí del Mig, 112 08349 Cabrera de Mar, Barcelona Spain Tel: 34-93-756 6286 Fax: 34-93-756 6287

Website: <http://www.motic.com>

E-mail: info@speedfair.com

Motic China Group., Ltd. (China)

Motic Building, Torch Hi-Tech Industrial, Development Zone, Xiamen P.R.C. Tel: 86-0592-562 7866 Fax: 86-0592-562 7855

©2007-2008 Motic China Group Co., Ltd. All rights reserved. Motic is a registered trademark and service mark of Motic China Group Co., Ltd. Microsoft Windows logo is a registered trademark of Microsoft Corporation. All other trademarks are the property of their respective owners.

Design Change: The manufacturer reserves the right to make changes in instrument design in accordance with scientific and mechanical progress, without notice and without obligation.