

Dr. meter Non-Contact Infrared Thermometer

Model: IR-60

User Manual

Safety Information

- Please read this user manual carefully before using the thermometer.
- Do not clean the thermometer with any solvents.
- Safety symbols:

 Important notices against hazards

 Compliant with European CE safety directive

This thermometer complies with the standards provided below:

- EN61326-1
- EN60825-1

Warning!

Do not point the thermometer's laser at anyone's eyes, or let the beam strike the eyes from any reflective surface.

Important Notices

- When introducing the thermometer to a new environment, allow the unit 30 minutes to adjust to temperature changes before usage. Temperature measurement can only resume when the meter's temperature is consistent with the new environment temperature.
- Keep the unit away from EMF (electro-magnetic fields) and induction heaters.
- Do not point the unit's laser directly at eyes.
- Do not leave the unit on or near objects with high temperatures.
- Do not use this unit in areas where explosive gas, steam, dust and smog are present to ensure uninterrupted measurement results.
- Keep the thermometer's lens cone free from frost, oil and dirt to ensure accurate temperature readings.

Product Illustration

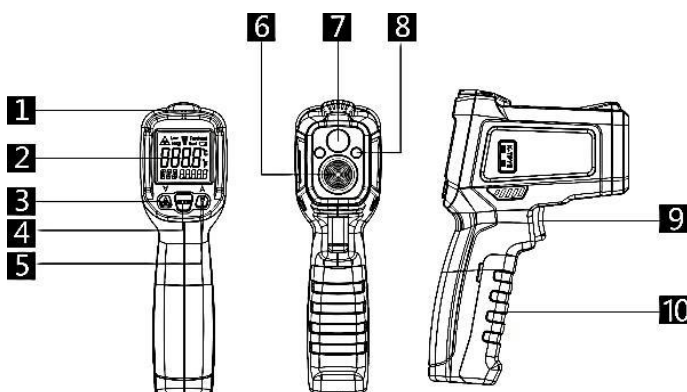

- ① Alarm indicator
- ② LCD Display
- ③ Laser /numeric decrease button
- ④ Mode button
- ⑤ Backlight/numeric increase button
- ⑥ Infrared sensor
- ⑦ Laser indicator
- ⑧ Backlight
- ⑨ Trigger button
- ⑩ Battery cover

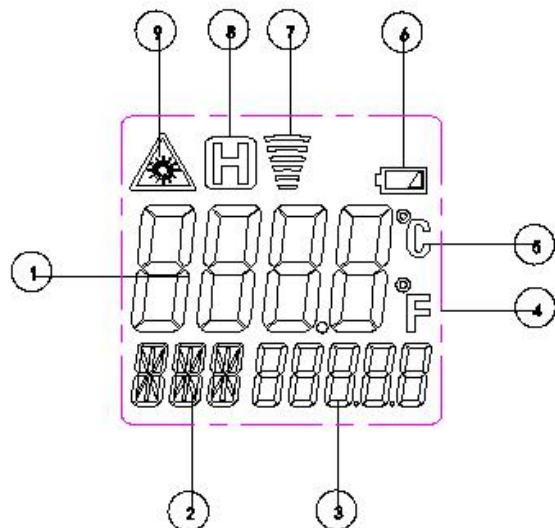

- ① Primary display panel: displays measured temperature.
- ② Functional indication: displays Max, HAL(high alarm level), LAL(low alarm level), E(emissivity)
- ③ Secondary display panel
- ④ Fahrenheit unit
- ⑤ Celsius unit
- ⑥ Low battery indicator
- ⑦ Temperature measurement indicator
- ⑧ Data hold
- ⑨ Laser on indicator (indicates that the laser is on)

Operating the Thermometer

1. Set the upper/lower limit values for alarms

Hold the trigger and mode button simultaneously to adjust the upper/lower limits set for the alarm. The functional indication display will show the HAL/LAL options, and the secondary display will show the upper/lower limits for the alarm. Press ▲/▼ key to increase or decrease the alarm value. A long hold on the ▲/▼ key will speed up the increase or decrease functions for the set value.

The default upper limit alarm value for this instrument is 5°C, and the default lower limit value is -5°C.

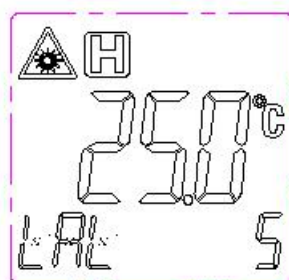

2. Set the emissivity

Press the trigger button to power up the device. The functional indication area will display the E symbol. Press the mode button to set the emissivity for the instrument. The functional indication area will display the ϵ symbol. Press the ▲/▼ buttons to increase or decrease the emissivity value. A long hold on the ▲/▼ key will speed up the increase or decrease functions in the set value.



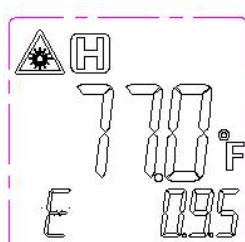
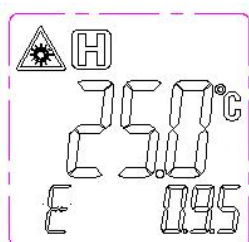

3. Set the temperature scale unit

Press the mode button for 2s to switch the temperature scale unit between Fahrenheit and Celsius.



4. Enable/disable laser

Press the  button to enable or disable laser. The instrument will display the  symbol on the display panel to indicate whether the laser is switched on or off

5. Turn on/off backlight

Press the  button to turn on or off the display screen's backlight.

6. Non-contact temperature measurement

Direct the thermometer at an object and hold the trigger button to carry out continuous temperature measurement. After the temperature reading has stabilized, release the trigger button to hold a temperature reading.

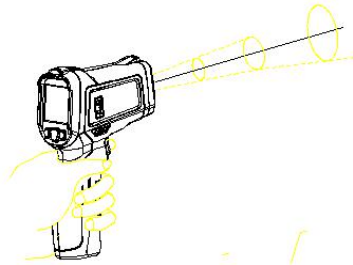

Upon pressing the trigger button,, the instrument's secondary display panel will first show the set emissivity, and then display the maximum temperature measured .

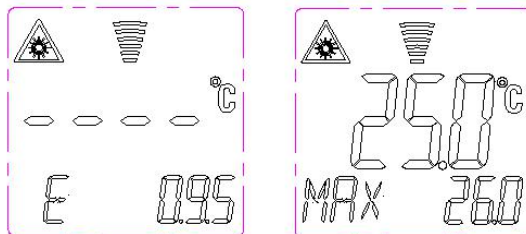

When the measured value is greater than the ambient temperature + HAL value, or the measured value is less than the ambient temperature + LAL value, the red LED indicator of the instrument will turn on. Otherwise, the green indicator will turn on.

7. Proportion between the distance from probe to object and the diameter of the object to be measured (D:S)

The thermometer has a specific field of view, as shown in the diagram below:

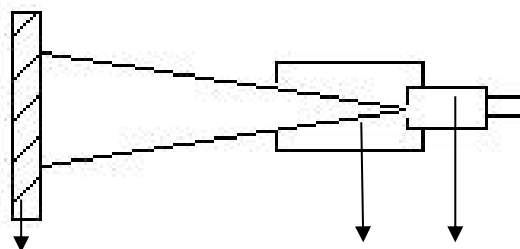

The object to be measured

Lens photosensitive cone element

Ensure that the object to be measured is placed within the field of view to get an accurate temperature reading. If the object is located outside the field, the thermometer will not be able to detect the object's temperature. The size of the object is proportionate to the distance required – the bigger the object is in size, the further it has to be placed away from the thermometer. Inversely, the smaller the object is in size, the nearer it has to be placed to the thermometer for accurate measurement. As the distance (D) from the object increases, the spot size (S) of the area measured by the unit increases, and has a ratio of 12:1, as shown in the diagram below:

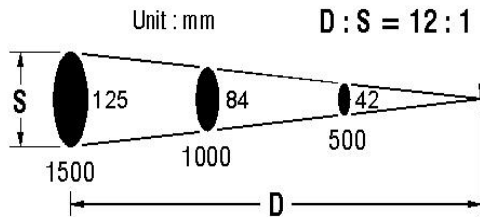

When the laser mode is on, the thermometer will project a circle of infrared dots on the target surface. The temperature reading displayed on the thermometer is read from the area inside the circle. While measuring an object, the instrument will emit an indicative ring. The measured temperature of the surface is the internal temperature of the ring.

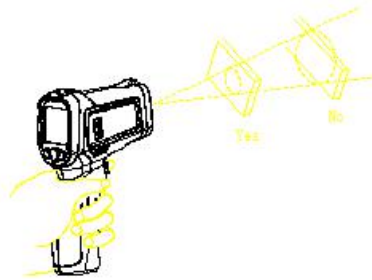

8. Emissivity

Emissivity refers to the ability of an object to emit infrared energy. Emissivity is determined by the object's composition and surface area. The emissivity of most organic materials or oxidized surfaces of metals falls within the range of 0.85~0.98. The default emissivity of this thermometer is 0.95. The thermometer's emissivity should be set to be consistent with that of the object to be measured..

The diagram provided below is a reference table for the emissivity of various surfaces:

Surface measured		Emissivity
Aluminum Metal	Oxidized	0.2~0.4
	A3003 Alloy	0.3
	A3003 Alloy Rough	0.1~0.3
Brass	Polished	0.3
	Oxidized	0.5
Copper	Oxidized	0.4~0.8
	Electronic terminal Board	0.6
Hastelloy		0.3~0.8
Chromium-Nickel-Iron Alloy	Oxidized	0.7~0.95
	Sandblast	0.3~0.6

	Electro-Polished	0.15
Iron	Oxidized	0.5~0.9
	Rusted	0.5~0.7
Iron(Cast)	Oxidized	0.6~0.95
	Non-oxidized	0.2
	Melt & cast	0.2~0.3
Iron(Forged) Passivated		0.9
Lead	Rough	0.4
	Oxidized	0.2~0.6
Mo Oxidized		0.2~0.6
Nickel Oxidized		0.2~0.5
Platinum Black		0.9
Steel	Cold rolled	0.7~0.9
	Polished plate	0.4~0.6
	Polished plate	0.1
Zinc	Oxidized	0.1
Asbestos		0.95
Asphalt		0.95
Basalt stone		0.7
Carbon		0.8~0.9
Non-oxidized		0.7~0.8
Graphite		0.9
Silicon Carbide		0.95
Clay		0.95
Concrete		0.95
Fabric		0.95
Glass plate		0.85
Sand-gravel		0.95
Gypsum		0.8~0.95
Ice		0.98
Limestone		0.98
Paper		0.95
plastic		0.95
Soil		0.9~0.98
Water		0.93
Wood (natural)		0.9~0.95

9. Battery replacement

When the battery's power is low, the top right corner will display  .

To replace the battery, open the battery cover and replace the old battery with a new 9V battery as shown in the illustration below:

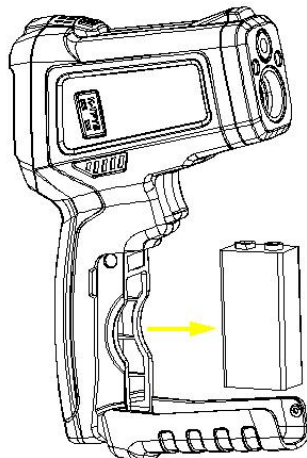

Specifications

Temperature range	-50°C ~ 550°C (-58°F ~ 1022°F)
Accuracy	0°C~550°C (32°F~1022°F): ±(1.5% reading + 2°C) -50°C~0°C(-58°F~32°F): ±3°C
LCD	Color LCD
D:S	12:1
Spectral response	8-14 um
Laser	<1mW /630-670nm Level 2
Response time	<0.5S
Automatic shutdown	15S
Operating temperature	0°C ~40°C
Storage temperature	-10°C ~ 60°C
Power	9V 6F22 battery