

Nutsetters



EAN:	4013288118158	Size:	50x20x20 mm
Part number:	05071225001	Weight:	41 g
Article number:	3869/4	Country of origin:	CZ
		Customs tariff number:	82042000

- Solution to the extraneous rust problem: fasten stainless screws with stainless tools
- Nutsetter for hexagon head screws
- Non-magnetic, with retaining spring, stainless steel against extraneous rust
- 1/4" hexagon drive (Wera connecting series 4)

High quality nutsetter out of stainless steel for hexagon head screws. Stainless to prevent the risk of extraneous rust. Non-magnetic design with retaining spring. 1/4" hexagon, suitable for holders as per, DIN ISO 1173-F 6.3.

Web link

https://products.wera.de/en/bits_holders_adaptors_and_sets_the_range_of_bits_nutsetters_3869_4.html

Wera - 3869/4
05071225001 - 4013288118158

Wera Werkzeuge GmbH
Korzerter Straße 21-25
D-42349 Wuppertal
Tel: +49 (0)2 02 / 40 45-0
E-Mail: info@wera.de

Nutsetters

Extraneous rust

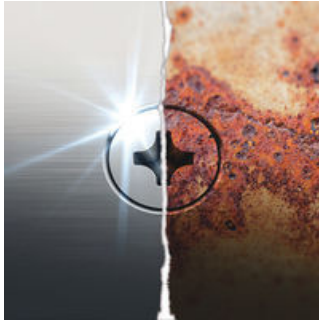

Stainless steel has the property of not rusting. However, if tools made out of conventional steel are used for stainless steel components or screws, the particles left behind from these tools can adhere to the surface and then rust. This effect - known as extraneous rust - can impair the visual appearance and even cause structural damage that may result in expensive repair work. The wear particles that cause this rust effect can be prevented by using stainless steel tools.

Screw stainless steel together with stainless steel!







Solution to the rust problem: screwdriving stainless steel together with stainless steel! Wera stainless steel tools are manufactured out of stainless steel so unsightly rust can be avoided.

Vacuum ice-hardened



The stainless steel tools from Wera are vacuum ice-hardened and have the hardness and strength needed for screw connections. There are no limitations to the industrial applications they are suitable for.

Further versions in this product family:

	 mm	 inch	 mm	 mm
05071222001	7.0	-	50.0	12.5
05071223001	8.0	-	50.0	14.0
05071224001	10.0	-	50.0	16.0
05071225001	13.0	-	50.0	19.5
05071228001	-	3/8"	50.0	16.0

Web link

https://products.wera.de/en/bits_holders_adaptors_and_sets_the_range_of_bits_nutsetters_3869_4.html

Wera - 3869/4
05071225001 - 4013288118158

Wera Werkzeuge GmbH
Korzter Straße 21-25
D-42349 Wuppertal
Tel: +49 (0)2 02 / 40 45-0
E-Mail: info@wera.de