

DIAMANTE

Studio Eurolinea Design, 2016



COLLECTION

www.interracontract.com
info@interracontract.com
O: 949.497.0277



FINISHES

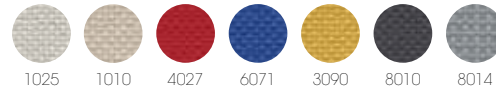

Diamante acoustic system is characterized by the large sizes of the sound absorbing panels, which can be located on walls, ceilings, floor screens or around desks.

BRACKET FINISHES

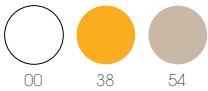

AVAILABLE VERSIONS

DIAMANTE

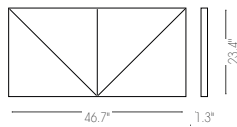
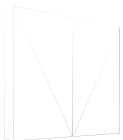

DIAMANTE DOUBLE

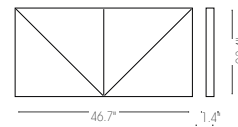

DIAMANTE SPOTLIGHT X2

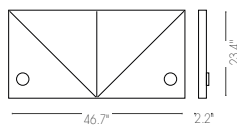
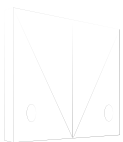

DIAMANTE SPOTLIGHT X4

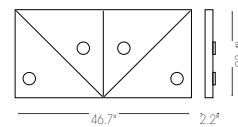

ACCESSORIES

VERTICAL SUSPENSION

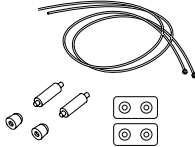

HORIZONTAL SUSPENSION

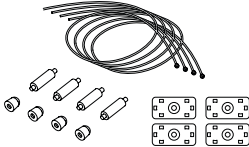

PEDESTAL

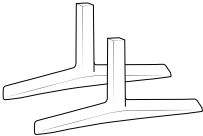

PARTITION LEG



WALL FIXING

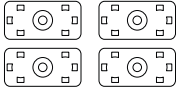

LIGHTING SYSTEM

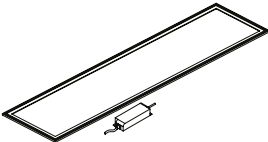

PARTITIONS

PARTITION A

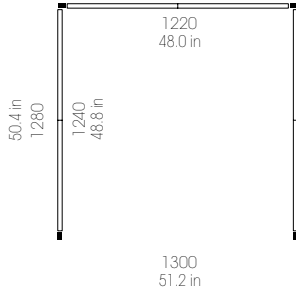

PARTITION B

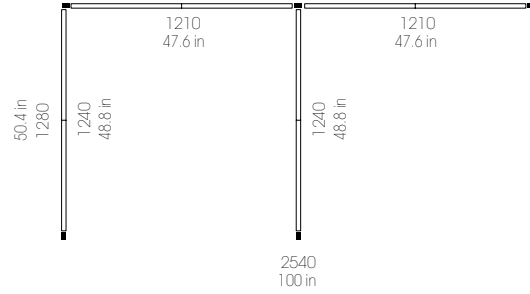

PARTITION C

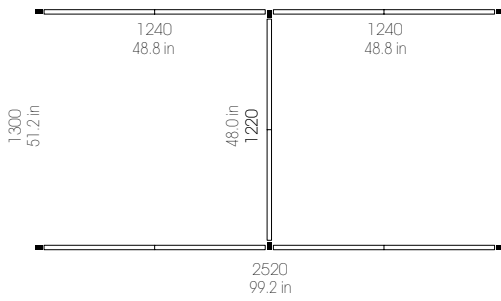

PARTITION D

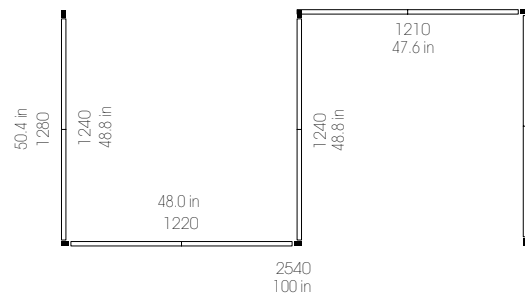

PARTITION E

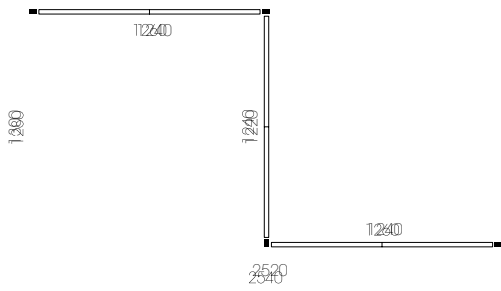

PARTITION F

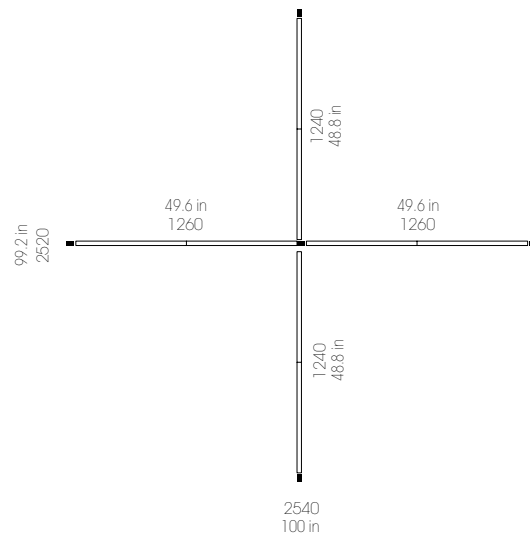

PARTITIONS

PARTITION A2

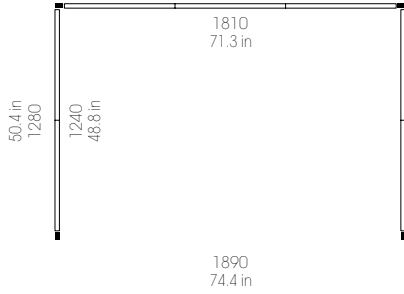

PARTITION B2

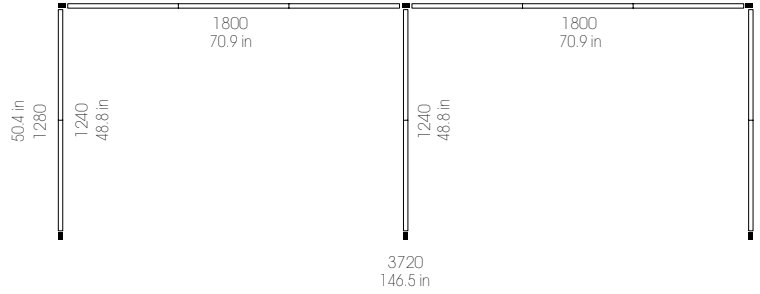

PARTITION C2

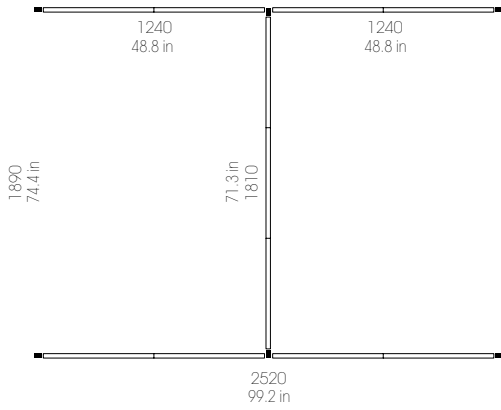

PARTITION D2

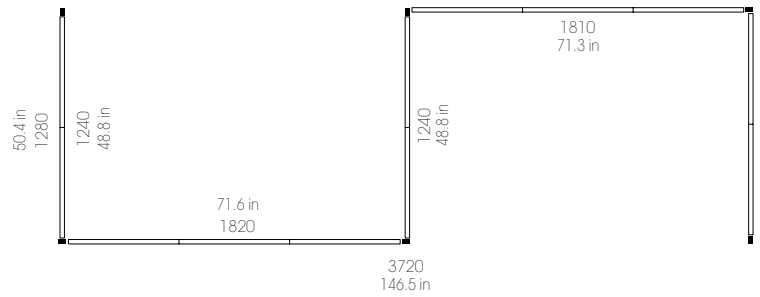

QUALITY IN THE NATURAL RESPECT

100% Demountable product
100% Recyclable material
100% Made in Italy

Collection certified UNI EN ISO 354:2003, sound absorption A Class following UNI EN ISO 11654:1998.

TECHNOPOLYMER

Gaber production employs exclusively high-tech thermoplastic materials, which are 100% recyclable. Gaber produces plastic injected materials without added chemicals. These materials are purchased within the European Union, so Gaber is exempted from registration with ECHA agency (European Agency for Chemicals Substances), in the complete respect of "Reach Regulation".

COVERINGS

Covering polyester materials follows fire retardant international standards.

I materiali di rivestimento adempiono alle più importanti normative antincendio internazionali.

UNI 9174 - 8456 Class C1, DIN 4102 Class B1, NF 92501-7 Class M1, Class AM18, EN 1021-1 & 2, BS Crib 5, BS 7176 Class Medium Hazard, IMO A 652 (16) Part 8 Upholstery

CARTON BOXES

Corrugated paperboard carton boxes, printed with environmentally friendly inks, are made of 90% recycled and recyclable materials. Packaging is sized in order to optimize storage and transport requirements, both helping the environment and saving on transport costs.