

Our selection

REPRESENTED BY:



ALMA

Abbiamo selezionato dal nostro catalogo i prodotti che più rappresentano la nostra anima e il nostro stile. Sedie, poltrone, sgabelli, tavoli e tavolini che interpretano al meglio lo spirito libero e sognatore di Alma, in nuove combinazioni di colori e finiture.

We have selected from our catalogue the products that best represent our soul and our style. Chairs, armchairs, stools, tables, and coffee tables that best interpret the free and dreamer spirit of Alma, in new combinations of colours and finishes.

ALMA[®]

Indice

About us

p. 5

A dream come true

p. 8

Finiture / Finishes

p. 258

Rivestimenti/ Materials

p. 264

Designer / Designers

p. 276

Collection

p. 278

Prodotti / Products

Sedie e poltroncine / Chairs and small armchairs

| | |
|----------|-------------|
| p. 74 | Agata |
| p. 144 | Amy |
| p. 204 | Estrosa |
| p. 96 | Jo Cuoietto |
| p. 186 | Jo |
| p. 152 | Julie |
| p. 80 | Lips |
| p. 162 | Marlene |
| p. 64 | Marnie |
| p.182 | Pepper Soft |
| p. 26-38 | Scala |
| p. 124 | Y Armchair |
| p. 128 | X Chair |

Sgabelli / Stools

| | |
|--------|---------|
| p. 194 | 2525 |
| p. 198 | Anouk |
| p. 204 | Estrosa |
| p. 188 | Jo |
| p. 42 | Scala |
| p. 132 | X Stool |

Poltrone e divani / Armchairs and sofas

| | |
|-------------|------------|
| p. 88 | Amarcord |
| p. 174 | Meg |
| p. 18-30-34 | Scala |
| p. 119 | X Big |
| p. 122 | X Big Too |
| p. 119 | X Pouf |
| p. 140 | X Big Foot |

Tavolini / Coffee tables

| | |
|----------|----------|
| p. 88 | Amarcord |
| p. 60 | Magenta |
| p. 220 | Malèna |
| p. 241 | Mojito |
| p. 180 | Pepper |
| p. 22-32 | Scala |
| p. 121 | X Table |

Panche / Benches

| | |
|--------|---------|
| p. 209 | Estrosa |
| p. 135 | X Beam |

Tavoli / Tables

| | |
|--------|------------|
| p. 170 | Bistrò |
| p. 234 | Ciak |
| p. 112 | Clint |
| p. 210 | Edward |
| p. 246 | Ice Table |
| p. 220 | Malèna |
| p. 66 | Marnie |
| p. 240 | Mojito |
| p. 108 | Paloalto |
| p. 228 | People |
| p. 254 | Priscilla |
| p. 43 | Scala |
| p. 250 | Set-up |
| p. 214 | Virna |
| p. 100 | Woodbridge |
| p. 121 | X Table |

Tappeti / Rugs

| | |
|-------|-------------|
| p. 54 | Raja e Lana |
|-------|-------------|



Francesca Mazzoleni, COO & Sales Manager
Alessandra Marchina, CEO

About us

Alma è un'azienda italiana che progetta e produce sedute, tavoli, imbottiti e complementi d'arredo dal design fresco e innovativo. Il suo nome è un nome di donna – una scelta istintiva per un'azienda al femminile, che ha saputo trasformare questa casualità in una delle sue peculiarità.

Alma is an Italian company that designs and produces chairs, tables, upholstered furniture and accessories with a fresh and innovative design. Alma is a feminine name – an instinctive choice for a women-run company, which has been able to transform this chance into one of its unique features.

Giovane perché nata nel 2007, Alma affonda le radici nella tradizione industriale del Made in Italy. Attenzione alla funzionalità e qualità senza compromessi sono un'eredità di famiglia, su cui si innesta un approccio estroverso e la passione per il design, tradotta in un'estetica riconoscibile fatta di semplicità e spensieratezza. Realtà solida e affidabile, Alma progetta in Franciacorta e produce nei migliori distretti italiani, realizzando arredi trasversali che arrivano nelle case, negli uffici e nei luoghi del contract di tutto il mondo.

Founded in 2007, Alma has roots in the industrial tradition of the "Made in Italy". Attention to functionality together with an uncompromised quality are a family inheritance: an extrovert attitude and a design passion are the key aspects of our company, whose recognisable styling made of simplicity and lightheartedness are unquestionable highlights. Alma - a solid and reliable reality - develops its products in the area of Franciacorta and has its suppliers network producing in the most known Italian districts, creating different elements for the residential market as well as for the worldwide contract one.

Alma

Estetica e funzionalità sono le linee guida della migliore progettazione e Alma le ha fatte proprie anche nella nuova sede aziendale di Passirano, in provincia di Brescia. Headquarters e showroom sono ospitati all'interno di un elegante volume color antracite. Progettato da Mario Mazzer Architects, è al contempo un ambiente dove è piacevole lavorare e un luogo accogliente per entrare in contatto con il mondo di Alma e i suoi prodotti. Sensibile al tema della sostenibilità, Alma opera nel rispetto e nella salvaguardia dell'ambiente, utilizzando processi produttivi puliti e materiali riciclabili.

Aesthetics and functionality represent our design guidelines. Our headquarters and showroom are located in Passirano, in the Province of Brescia. Headquarters and showroom are hosted in an elegant anthracite grey building. Planned by Mario Mazzer Architects, it is both a comfortable place to work in and a pleasant building to get in touch with Alma and its products. Sensitive to sustainability concept, Alma respects and safeguards the environment using clean manufacturing processes and recyclable materials.

About us



Azienda con sistema di gestione qualità certificato ISO 9001:2015. / Company with quality system ISO 9001:2015.



Famiglia

Il cuore di Alma sono Alessandra, Francesca e Lorenza, madre e figlie alla guida di un'azienda che a sua volta prende origine da un'impresa familiare, produttrice da due generazioni di componenti in tubo metallico per il mondo dell'arredo. La famiglia è un valore e una realtà: comprende le persone che lavorano per Alma, quasi tutte donne; i partner che, ciascuno secondo la sua specialità, contribuiscono all'eccellenza del prodotto; i designer che negli anni hanno condiviso progetti e successi.

Family

Alma's heart are Alessandra, Francesca and Lorenza, mother and daughters at the head of a company originating from a family business which has been producing - for two generations' time - tube items for the furniture world. Family is a value and a reality: it comprehends people who work for Alma, nearly all women; partners who contribute to the excellence of the product, each one for its peculiarities; designers who in these last years have shared their products and success.

Alma

Design

Il design per Alma è un connubio di tecnica ed estetica. La tecnica è funzionalità, eccellenza nelle lavorazioni, attenzione alla qualità dei materiali. L'estetica si esprime attraverso la freschezza della semplicità e del colore. Quasi un manifesto d'intenti e di stile, il primo prodotto presentato da Alma si chiamava Estrosa: la più grande matrice di estrusione mai realizzata dà vita a una sedia innovativa, colorata ed evocativa.

Design

Alma's design is the perfect combination of technique and aesthetics. Technique means functionality, excellence in the processing, attention to the quality of materials. Aesthetics expresses itself through fresh colours and simplicity. Almost a manifesto of intent and style, the first product presented by Alma was named Estrosa: the greatest matrix of extrusion ever realized gives birth to an innovative, colorful and evocative chair.



A dream come true



Italianità

Sedie, tavoli e complementi di Alma sono profondamente Made in Italy. Sono realizzati nei migliori distretti produttivi del Nord Italia da aziende specializzate. Una struttura produttiva snella e affidabile che offre la massima flessibilità, espressione di un'abilità artigianale unica, frutto dell'esperienza e di una cultura del lavoro che considera fondamentale la qualità dei materiali e la perfezione dei dettagli.

Italianity

Chairs, stools and all other elements are totally Made in Italy. They are made in the best production areas of the North of Italy from specialized firms. A fast and reliable production structure that offers the best flexibility, expression of a unique handmade ability, result of the experience of a culture of work that considers as fundamental points materials quality and details perfection.



Prodotti
Products

Scala

Indoor Outdoor

La collezione Scala è un tributo a Milano, città di cultura e di storia, capitale della moda e del design. La collezione è progettata per offrire un'esperienza di living completa e una sinergia inedita tra interno ed esterno. Linee sinuose che si fondono con l'ambiente circostante per coordinare indoor e outdoor che, oggi più che mai, si integrano e si compenetrano l'uno con l'altro dando origine a soluzioni ricercate e sofisticate in termini di stile, colore e materiali per soddisfare esigenze di arredo influenzate dal design e dalla moda. La struttura in metallo, che accomuna le proposte indoor e outdoor, restituisce leggerezza ed eleganza a tutti gli elementi. La collezione Scala Indoor è composta da poltrona, divano a due posti, coffee table, sedia, sgabello e tavolo fisso e allungabile. La collezione Scala Outdoor comprende poltroncina, poltrona, divano a due posti, coffee table e tavolo fisso.

The Scala collection is a tribute to Milan, a city of culture and history, capital of fashion and design. The collection is designed to offer a total living experience and an original synergy between indoor and outdoor. Soft lines that blend in with the surroundings to harmonize indoor and outdoor spaces that, now more than ever, interact and communicate with each other, creating a refined solution in terms of style, color and materials, inspired by haute couture and capable of meeting every design need. The metal structure, which brings the indoor and outdoor offerings together, conveys lightness and elegance to all the elements. The Scala Indoor Collection includes an armchair, a two-seat sofa, a coffee table, a chair, a stool, fixed and extendable table. The Scala Outdoor collection features chair, armchair, two-seat sofa, coffee table and fixed table.

Designer
Marco Piva

Armchair

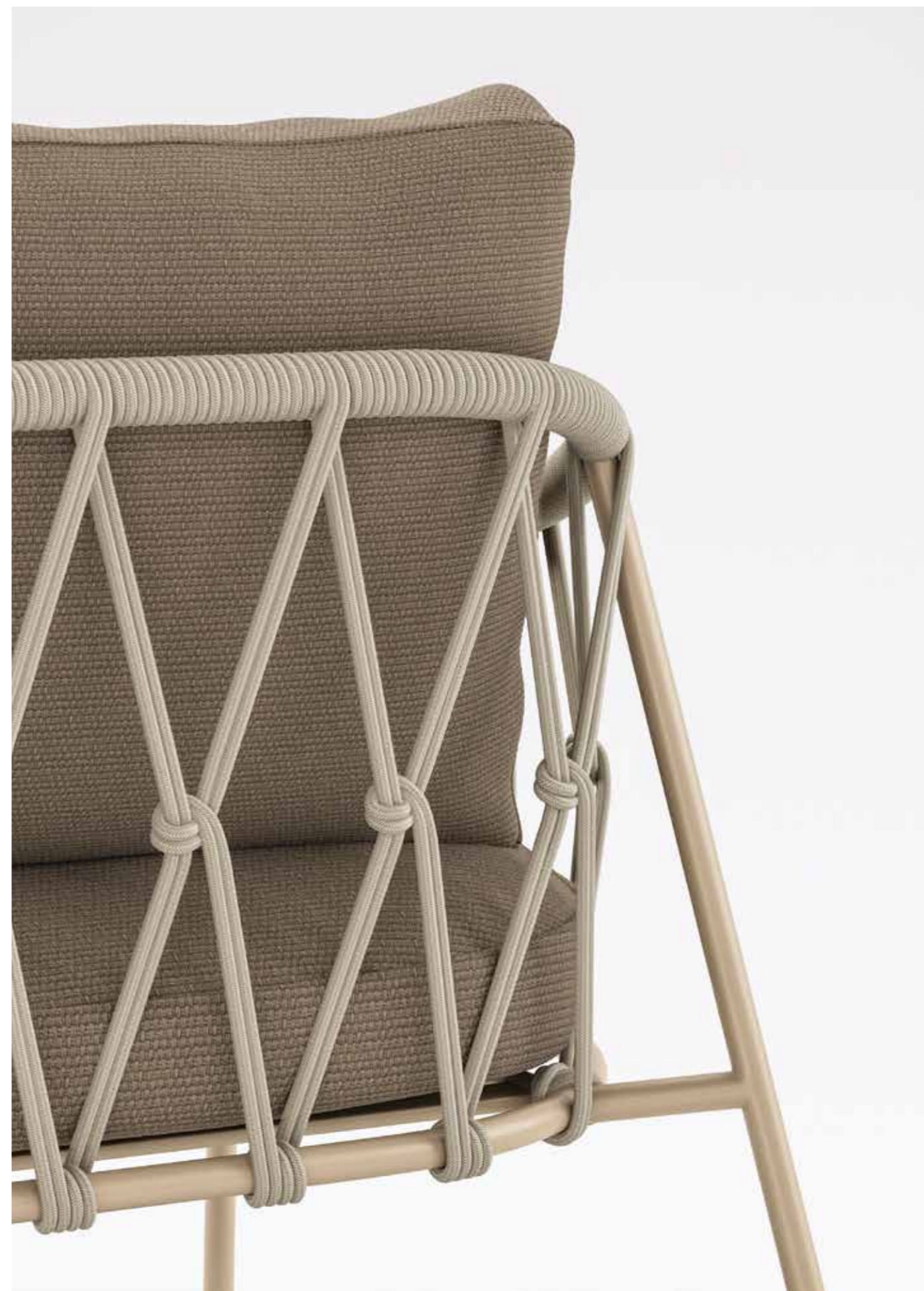

Divano e poltrone Scala con struttura in acciaio verniciato antracite e intreccio in corda polipropilene vinaccia. Cuscini divano in tessuto Tropea, cuscini poltrone in tessuto Tropea e Salina.

Scala sofa and armchairs with anthracite painted steel frame, polypropylene burgundy rope. Sofa cushions in Tropea fabric, armchairs cushions in Tropea and Salina fabric.



Divano e poltrona Scala con struttura in acciaio verniciato antracite e intreccio in corda polipropilene antracite, cuscini in tessuto Tropea. Tavolini con struttura in acciaio verniciato antracite, ovale in HPL color lava opaco e tondo in HPL antracite. Tappeto Raja in poliestere riciclato.

Scala sofa and armchair with anthracite painted steel structure and polypropylene anthracite rope, cushions in Tropea fabric. Scala coffee tables with anthracite painted steel frame, oval HPL top in matt lava color, round HPL top in anthracite color. Raja rug in recycled polyester.



Divano e poltrona Scala con struttura in acciaio verniciato sabbia e intreccio in corda polipropilene sabbia, cuscini in tessuto Fortezza. Tavolino con struttura in acciaio verniciato sabbia piano tondo in HPL color sabbia.

Tappeto Raja in poliestere riciclato.

Scala sofa and armchair with sand painted steel structure and polypropylene sand rope, cushions in Fortezza fabric. Scala coffee tables with sand painted steel frame, round HPL top sand color.

Raja rug in recycled polyester.

Poltroncine Scala con telaio in acciaio verniciato bianco, intreccio in corda di polipropilene sabbia, cuscino con tessuto Itaca. Tavolo Scala con struttura in acciaio verniciato bianco e piano in HPL color calacatta.

Scala small armchairs white painted steel frame, polypropylene sand rope, cushions Itaca fabric. Scala table with white painted steel frame and HPL top calacatta color.



Scala



Poltroncine Scala, con struttura in acciaio verniciato bianco intreccio in corda di polipropilene sabbia e cuscino con tessuto Fortezza; con struttura in acciaio verniciato antracite, intreccio in corda di polipropilene antracite e cuscino con tessuto Fortezza.

Scala small armchairs, with white painted steel frame sand polypropylene rope and cushions in Fortezza fabric; with anthracite painted steel frame, anthracite polypropylene rope and cushions in Fortezza fabric.

Chair



Scala



Poltrona Scala con struttura in acciaio verniciato bronzo e seduta in pelle.
Tavolino Scala basso con struttura in acciaio verniciato bronzo e piano in MDF laccato rosso ossido.

Scala armchair with bronze painted steel structure and leather seat.

Scala low coffee table with structure in bronze painted steel and red oxide lacquered MDF top.

Armchair, coffee table

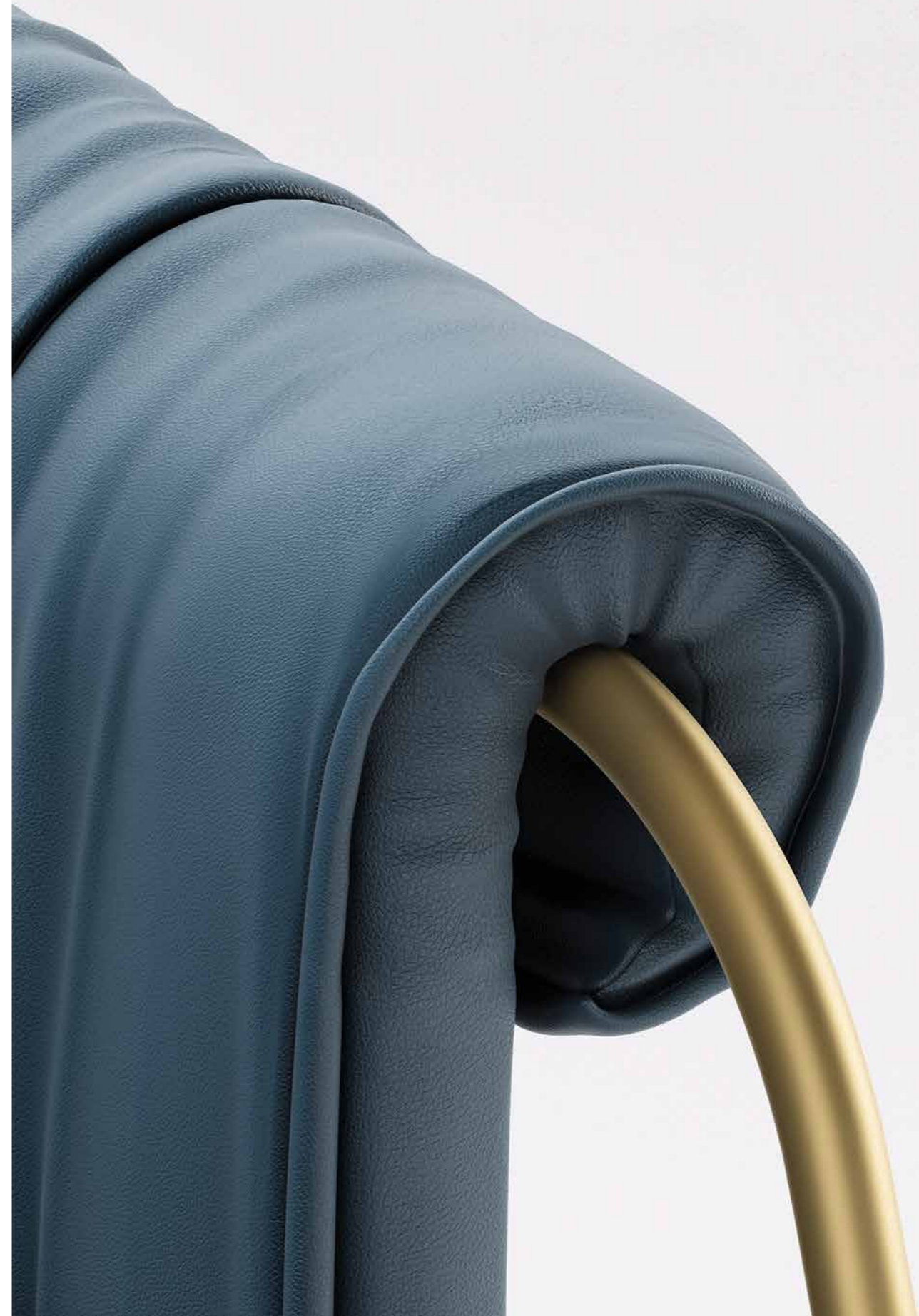

Tavolini Scala con struttura in acciaio verniciato bronzo e piano in MDF laccato bianco; con struttura in acciaio verniciato nero e piano in MDF laccato bianco; con struttura in acciaio verniciato bronzo e piano in MDF laccato rosso ossido.

Scala coffee tables with bronze painted steel structure and white lacquered MDF top; with structure in black painted steel and white lacquered MDF top; with structure in bronze painted steel and red oxide lacquered MDF top.



Scala

Divani Scala con struttura in acciaio verniciato bronzo e rivestimento Stone Velvet e velluto Luna.
Tappeto Lana, bouclé misto lana e viscosa.
*Scala sofas with steel painted bronze frame, upholstered in Stone Velvet and velluto Luna.
Lana rug, bouclé in wool and viscose.*



Sofa



Poltrona e divano Scala con struttura in acciaio verniciato nero rivestiti in ecopelle Touch; tavolino ovale con struttura in acciaio verniciato nero e piano HPL color Impero Nero opaco.

Tappeto Lana, bouclè misto lana e viscosa.

Scala armchair and sofa with black painted steel frame, upholstered in ecoleather Touch; oval coffee table, black painted steel frame and HPL top matt Black Imper color. Lana rug, bouclè in wool and viscose.



Scala

Sedie Scala con struttura in acciaio verniciato nero rivestite in ecopelle Touch; tavolo Scala allungabile con struttura in acciaio verniciato nero e piano in laminato nero.

Tappeto Lana, bouclé misto lana e viscosa.

Scala chairs with black painted steel frame upholstered in Touch ecoleather;

Scala extendable table in black painted steel frame and laminate black top.

Lana rug, bouclé in wool and viscose.

Chair



Scala



Chair

Sedie Scala con struttura in acciaio verniciato bronzo rivestite in ecopelle Touch.

Scala chairs with bronze painted steel frame upholstered with Touch ecoleather.



Scala

Sgabelli Scala con struttura in acciaio verniciato bronzo rivestito con Stone velvet.
Scala stools with bronze painted steel structure upholstered with Stone velvet.



Stool, table

Tavolo allungabile Scala con struttura in acciaio verniciato bronzo, meccanismo in alluminio verniciato nero, piano in HPL d.1200 mm brown lucido, prolunga centrale in laminato nero da 400 mm.

Scala extendable table with bronze painted steel frame, black painted aluminium mechanism, HPL top d.1200 mm shiny brown colour, central extension in black laminate 400 mm.



Tavoli Scala con struttura in acciaio verniciato bronzo: allungabile con piano in HPL brown lucido e prolunga in laminato nero; fisso con piano da 2000x1000 mm in HPL color Impero Nero opaco.

Scala tables with bronze painted steel frame: extendable with HPL shiny brown and extensions in black laminate; fix top version with 2000x1000 mm HPL top matt Black Imper color.

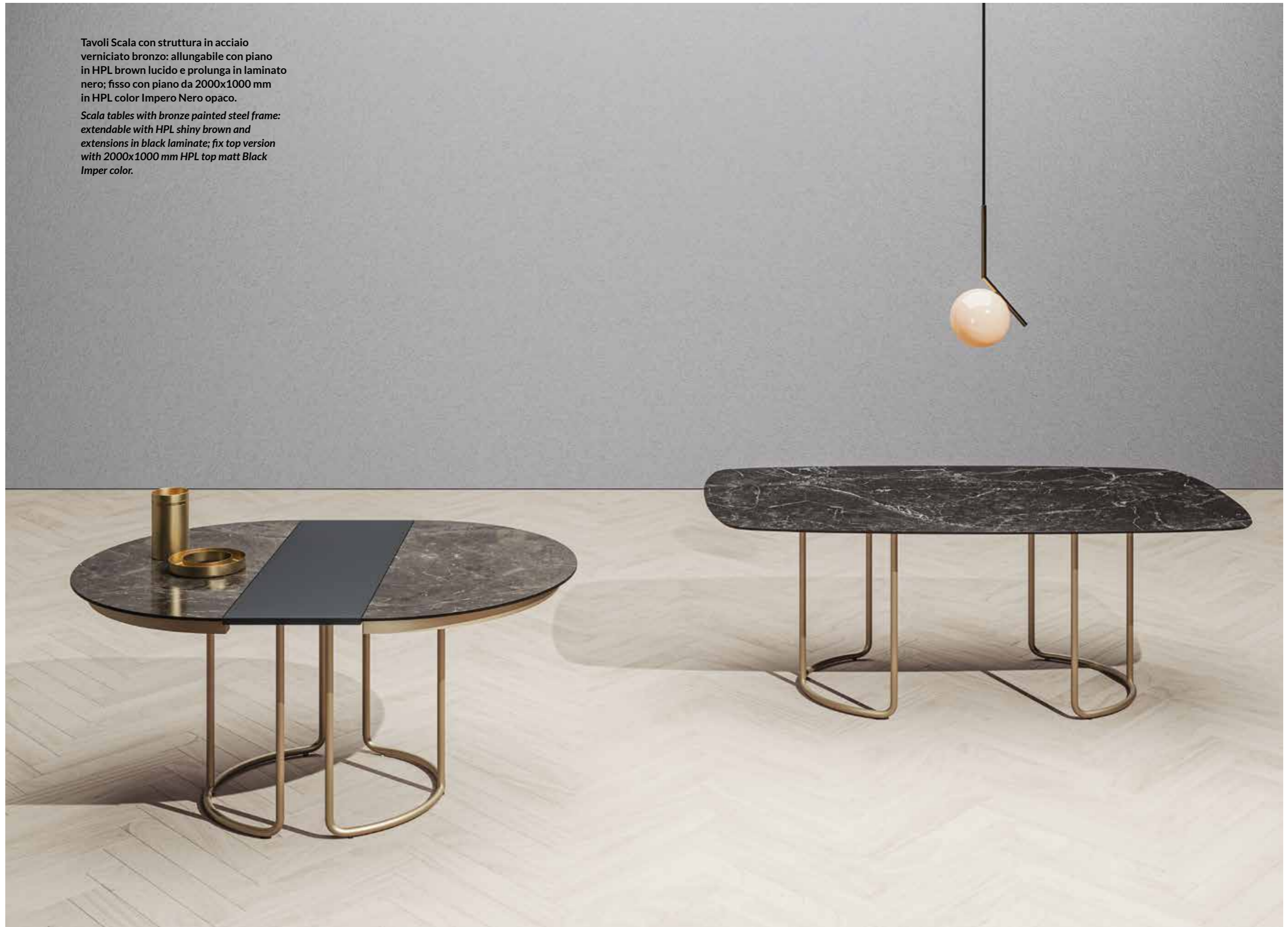

Scala armchair, sofa

Varianti / Versions



A – 2140

Poltrona outdoor con struttura in acciaio verniciato, corda in polipropilene e cuscini imbottiti. / Outdoor armchair with painted steel frame, polypropylene rope and upholstered cushions.



B – 7140

Divano outdoor a 2 posti con struttura in acciaio verniciato, corda in polipropilene e cuscini imbottiti. / Outdoor 2 seats sofa with painted steel frame, polypropylene rope and upholstered cushions.

Dimensioni / Dimensions

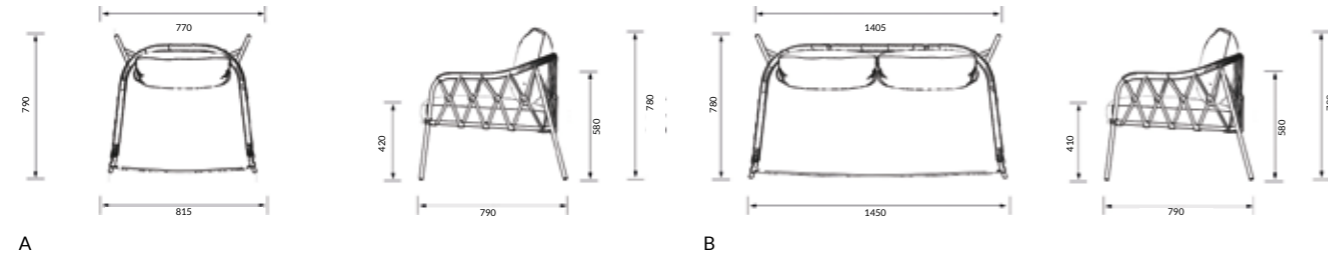

A

B

Struttura / Frames

Metalli / Metals



VB Verniciato bianco
White painted
VS Verniciato sabbia
Sand painted
VT Verniciato antracite
Anthracite painted

Corda / Rope



TR001 Sabbia
Sand
TR002 Antracite
Anthracite
TR003 Vinaccia
Bordeaux

Rivestimenti / Materials

CAT C Fortezza - Itaca
CAT D Tropea
CAT E Salina

Scala chair

Varianti / Versions



A – 2150

Poltroncina outdoor con struttura in acciaio verniciato, corda in polipropilene e cuscino imbottito. / Outdoor little armchair with painted steel frame, polypropylene rope and upholstered cushion.

Dimensioni / Dimensions

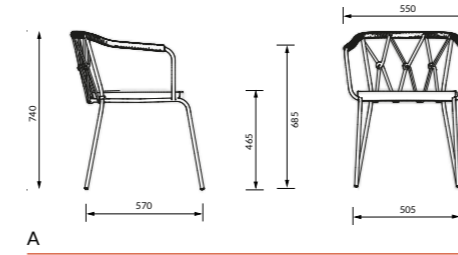

A

Struttura / Frames

Metalli / Metals



VB Verniciato bianco
White painted
VS Verniciato sabbia
Sand painted
VT Verniciato antracite
Anthracite painted

Corda / Rope



TR001 Sabbia
Sand
TR002 Antracite
Anthracite
TR003 Vinaccia
Bordeaux

Rivestimenti / Materials

CAT C Fortezza - Itaca
CAT D Tropea
CAT E Salina

Scala armchair, sofa

Varianti / Versions



A – 2130

Poltrona imbottita con struttura in acciaio verniciato. / Upholstered armchair with steel painted frame.



B – 7130

Divano imbottito con struttura in acciaio verniciato. / Upholstered sofa with painted steel structure.

Dimensioni / Dimensions

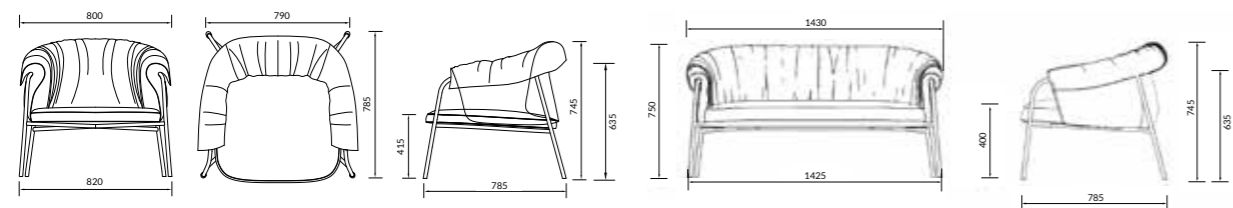

A

B

Struttura / Frames

Metalli / Metals



VAG
Bronzo
Bronze

VNO
Verniciato nero
Black polished

Rivestimenti / Materials

CAT A Spalmato - Touch
CAT B Stone Velvet - Origami - Jojo
CAT C Capri
CAT D Plush - Velluto Luna
CAT E Hero
CAT PE Pelle Miami
CAT PE1 Pelle Lotus

Scala chair indoor, Scala stool

Varianti / Versions



A – 1130

Sedia imbottita con struttura in acciaio verniciato. / Upholstered chair with painted steel structure.



B – 4130

Sgabello imbottito con struttura in acciaio verniciato. / Upholstered stool with painted steel structure.

Dimensioni / Dimensions

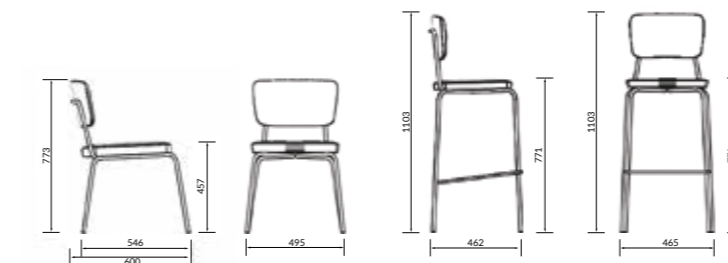

A

B

Struttura / Frames

Metalli / Metals



VAG
Bronzo
Bronze

VNO
Verniciato nero
Black polished

Rivestimenti / Materials

CAT A Spalmato - Touch
CAT B Stone Velvet - Origami - Jojo
CAT C Capri
CAT D Plush - Velluto Luna
CAT E Hero
CAT PE Pelle Miami
CAT PE1 Pelle Lotus

Scala fixed table

Varianti / Versions



A – 3770T12

Tavolo tondo con struttura in acciaio verniciato H 728/738 con piano in hpl/laminato Ø 1190.
/ Round table with painted steel frame H 728/738 with hpl/laminated Ø 1190 top.



B – 3770T14

Tavolo tondo con struttura in acciaio verniciato H 728/738 con piano in hpl/laminato Ø 1390.
/ Round table with painted steel frame H 728/738 with hpl/laminated Ø 1390 top.



C – 3770O16

Tavolo ovale con struttura in acciaio verniciato H 728/738 e piano in hpl/laminato 1590x1090.
/ Oval table with painted steel frame H 728/738 with hpl/laminated 1590x1090 top.



D – 3770O20

Tavolo ovale con struttura in acciaio verniciato H 728/738 e piano in hpl/laminato 1990x1090.
/ Oval table with painted steel frame H 728/738 with hpl/laminated 1990x1090 top.

Dimensioni / Dimensions

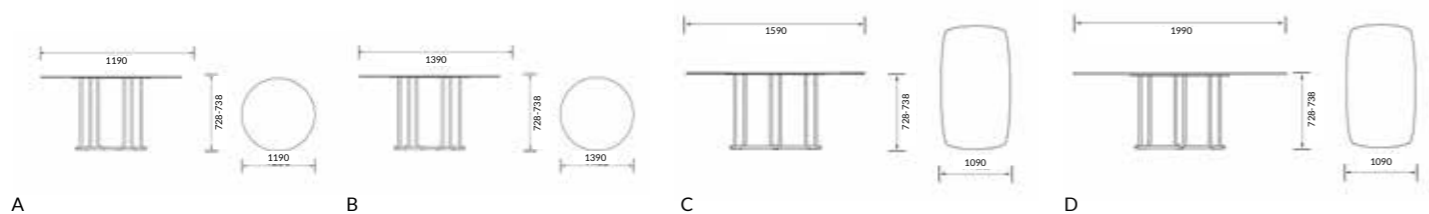

Colori piano / Top colors

Hpl / Hpl

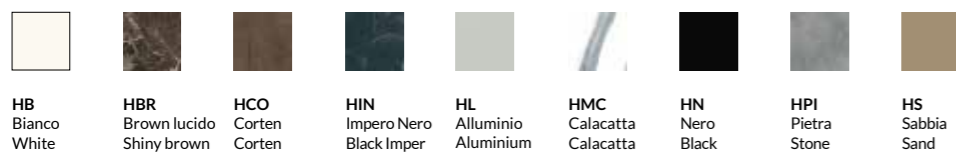

HB Bianco White
HBR Brown lucido Shiny brown
HCO Corten Corten
HIN Impero Nero Black Imper
HL Alluminio Aluminium
HMC Calacatta Calacatta
HN Nero Black
HPI Pietra Stone
HS Sabbia Sand

Laminato / Laminated

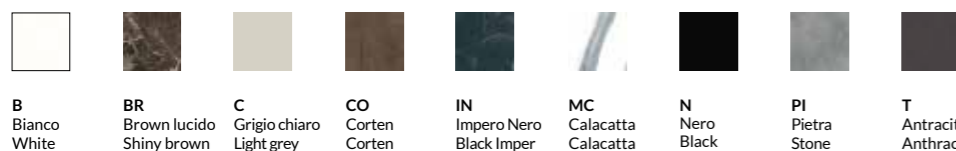

B Bianco White
BR Brown lucido Shiny brown
C Grigio chiaro Light grey
CO Corten Corten
IN Impero Nero Black Imper
MC Calacatta Calacatta
N Nero Black
PI Pietra Stone
T Antracite Anthracite

Struttura / Frames

Metalli per indoor / Metals for indoor



VAG Bronzo Bronze
VNO Verniciato nero Black polished

Metalli per outdoor / Metals for outdoor

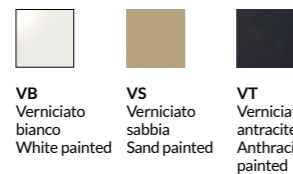

VB Verniciato bianco White painted
VS Verniciato sabbia Sand painted
VT Verniciato antracite Anthracite painted

Scala extending table

Varianti / Versions



A – 3771T12

Tavolo allungabile con struttura in acciaio verniciato H 760/770 e piano in hpl/laminato diam.1190+400. Prolunghe in laminato. / Extendable table with painted steel frame H 760/770 and hpl/laminated top diam.1190+400. Extendable part in laminated.

Dimensioni / Dimensions

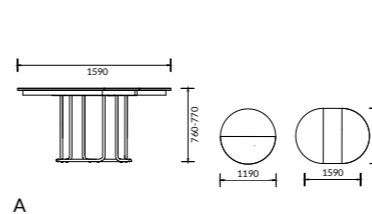

Colori piano / Top colors

Hpl / Hpl

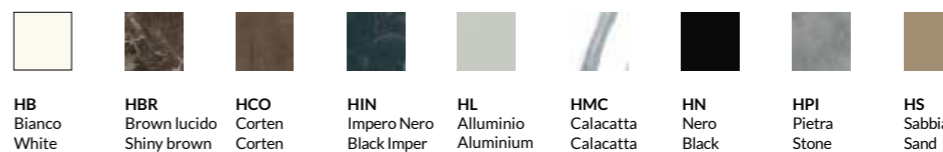

HB Bianco White
HBR Brown lucido Shiny brown
HCO Corten Corten
HIN Impero Nero Black Imper
HL Alluminio Aluminium
HMC Calacatta Calacatta
HN Nero Black
HPI Pietra Stone
HS Sabbia Sand

Laminato / Laminated

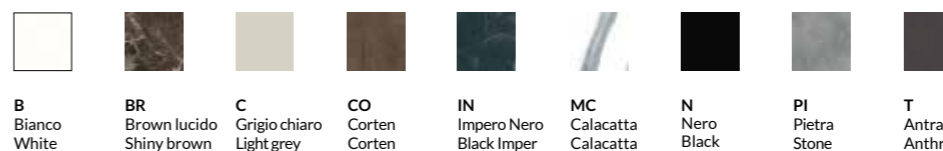

B Bianco White
BR Brown lucido Shiny brown
C Grigio chiaro Light grey
CO Corten Corten
IN Impero Nero Black Imper
MC Calacatta Calacatta
N Nero Black
PI Pietra Stone
T Antracite Anthracite

Struttura / Frames

Metalli per indoor / Metals for indoor

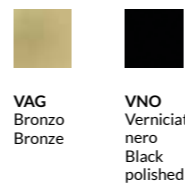

VAG Bronzo Bronze
VNO Verniciato nero Black polished

Scala Coffee table

Varianti / Versions



A – 3760H4

Tavolino con struttura in acciaio verniciato H 400 e piano MDF Ø 400. / Coffee table painted steel frame H 400 with MDF Ø 400 top.



B – 3760H5

Tavolino con struttura in acciaio verniciato H 505 e piano MDF Ø 500. / Coffee table painted steel frame H 505 with MDF Ø 500 top.



C – 3760H6

Tavolino con struttura in acciaio verniciato H 600 e piano MDF Ø 360. / Coffee table painted steel frame H 600 with MDF Ø 360 top.

Dimensioni / Dimensions

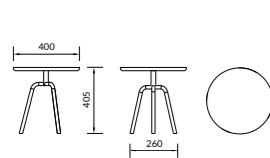

A

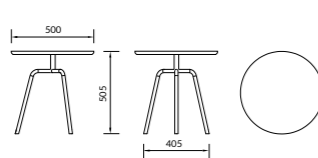

B

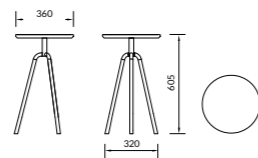

C

Colori Piano / Top colors

Mdf / Mdf



LE05B Laccato bianco freddo / Cold white lacquered
LE07 Laccato nero / Black lacquered
LE25 Laccato grigio ghiaia / Pebble grey lacquered
LE26 Laccato rosso ossido / Red oxide lacquered

Struttura / Frames

Metalli / Metals



VAG Bronzo / Bronze
VNO Verniciato nero / Black polished

Scala Coffee table

Varianti / Versions



A – 3761T

Tavolino con struttura in acciaio verniciato H 345/367 mm con piano Ø 750 in hpl/mdf. / Coffee table with painted steel frame H 345/367 mm with Ø 750 hpl/mdf top.



B – 3761O

Tavolino con struttura in acciaio verniciato H 345/367 mm con piano ovale da 990/1000x690 in hpl/mdf. / Coffee table with painted steel frame H 345/367 mm with 990/1000x690 hpl/mdf oval top.



C – 3762T

Tavolino in acciaio verniciato H 490/512 mm con piano Ø 390/400 in hpl/mdf. / Coffee table with painted steel frame H 490/512 mm with Ø 390/400 hpl/mdf top.

Dimensioni / Dimensions

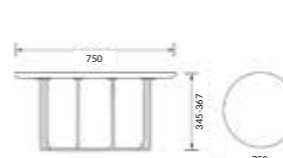

A

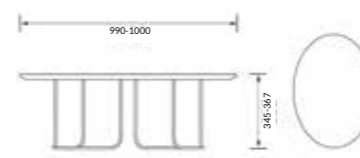

B

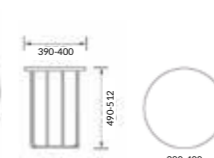

C

Colori piano / Top colors

Mdf / Mdf



LE05B Laccato Bianco freddo / Cold white lacquered
LE07 Laccato nero / Black lacquered
LE25 Laccato grigio ghiaia / Pebble grey lacquered
LE26 Laccato rosso ossido / Lacquered oxide red

Hpl / Hpl



HB Bianco / White
HBR Brown lucido / Shiny brown
HCO Corten / Corten
HIN Impero Nero / Black Imper
HL Alluminio / Aluminium
HMC Calacatta / Calacatta
HN Nero / Black
HPI Pietra / Stone
HS Sabbia / Sand

Struttura / Frames

Metalli per indoor / Metals for indoor



VAG Bronzo / Bronze
VNO Verniciato nero / Black polished

Metalli per outdoor / Metals for outdoor



VB Verniciato bianco / White painted
VS Verniciato sabbia / Sand painted
VT Verniciato antracite / Anthracite painted

Ad arricchire la proposta total living di Alma la nuova collezione di tappeti per indoor e outdoor. I modelli Lana da interno sono interamente annodati a mano con effetto bouclé a nodi in rilievo. Tappeti morbidi e a nodi fissi altamente resistenti all'usura, composti al 40% da lana e al 60% da viscosa che gli conferisce un effetto luminoso.

In un'ottica ecosostenibile i tappeti Raja da esterno sono realizzati completamente in poliestere riciclato, una fibra tessile sintetica che si ottiene fondendo la plastica e rifilandola in una nuova fibra di poliestere, che consente di dare una seconda vita a dei materiali non biodegradabili.

The new collection of indoor and outdoor rugs enriches Alma's Total Living offerings.

Lana indoor rugs are entirely hand-knotted with a raised knot bouclé effect. Soft, fixed-knot, and highly wear-resistant rugs, composed of 40% wool and 60% viscose, which gives them a shiny finish.

Environmentally conscious, Raja outdoor rugs are entirely made by recycled polyester, a synthetic textile fiber obtained by re-melting plastic into a new polyester fiber, giving non-biodegradable materials a second life.

Designer
Alma

Tappeto Raja in melange blu e tappeto Lana color nature.

Raja rug melange blu and Lana rug in nature colour.



Tappeto Lana, bouclè misto lana e viscosa.
Poltrona e divano Scala con struttura
in acciaio verniciato nero rivestiti in
ecopelle Touch; tavolino ovale con struttura
in acciaio verniciato nero e piano HPL color
lava opaco.

*Lana rug, bouclè in wool and viscose.
Scala armchair and sofa with black painted
steel frame, upholstered in ecoleather Touch;
oval coffee table, black painted steel frame
and HPL top matt lava colour.*





Tappeto Raja in poliestere riciclato.
Divano e poltrona Scala con struttura
in acciaio verniciato antracite e intreccio
in corda poliestere antracite, cuscini in
tessuto Tropea. Tavolini con struttura in
acciaio verniciato antracite, ovale in HPL
color lava opaco e tondo in HPL antracite.

*Raja rug in recycled polyester.
Scala sofa and armchair with anthracite
painted steel structure and polyester
anthracite rope, cushions in Tropea fabric.
Scala coffee tables with anthracite painted
steel frame, oval HPL top in matt lava color,
round HPL top in anthracite colour.*

Varianti / Versions



A – 8010

Tappeto da outdoor Raja con
intreccio in poliestere riciclato.
/ Raja outdoor rug with recycled
polyester interweaving.



B – 8020

Tappeto Lana annodato a mano
con effetto bouclé a nodi in rilievo.
/ Hand-knotted rug with bouclé
effect with raised knots.

Dimensioni / Dimensions

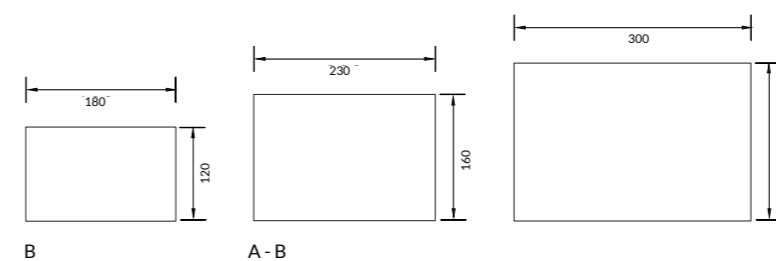

B

A - B

Colori / Colors

Outdoor / Outdoor



RA01
Melange
nature
Nature
melange

RA02
Melange blu
Blue Melange

Indoor / Indoor



LA01
Nature
Nature

LA02
Marrone
Brown

LA03
Grigio
Grey

Magenta

Magenta è un colore, ma è soprattutto una delle vie storiche di Milano, ancora oggi tra le più caratteristiche. E proprio le atmosfere eleganti e ricercate delle residenze milanesi del centro hanno ispirato i tavolini della collezione Magenta, realizzata con materiali che richiamano gli anni Cinquanta e rappresentano un omaggio alla stagione d'oro del design italiano.

Magenta is a colour, but also one of the most ancient and characteristic streets in Milan. Exactly those elegant and prestigious features of the buildings in the city-centre have inspired for the Magenta collection tables, made with materials that recall the 50's and represent a tribute to the golden season of the Italian design.

Designer
Marco Piva

Coffee table

Tavolini Magenta con struttura in metallo verniciato nero e piano in marmo nero marquina e con struttura in metallo verniciato nero e piano in marmo Carrara lucido.

Magenta coffee tables with structure in black painted metal and top in black marquina marble with structure in black painted metal and top in glossy Carrara marble.



Tavolino Magenta H 520 mm con piano tondo d.525 mm in marmo nero marquina con particolare lavorazione del bordo.

Magenta coffee table H 520 mm with black marquina marble top, d.525 mm, edge detail.



Varianti / Versions



A – 3750H35

Tavolino H 365 con piano ovale 1220x820. / *Coffee table H 365 oval shape 1220x820.*



B – 3750H55

Tavolino H 520 con piano tondo Ø 525. / *Coffee table H 520 with top Ø 525.*

Dimensioni / Dimensions

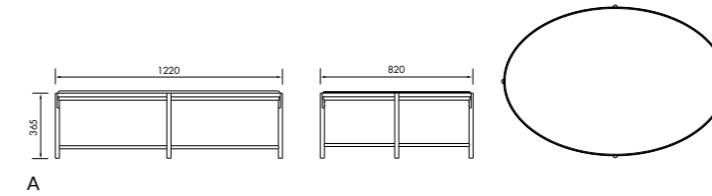

A

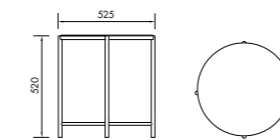

B

Colori Piano / Top colors

Mdf / Mdf



LE05B
Laccato bianco
White
laquered



LE07
Laccato nero
Black
laquered



LE25
Laccato grigio
ghiaia
Pebble grey
laquered



LE26
Laccato rosso
ossido
Red oxide
laquered

Marmo / Marble



MCL*
Marmo
Carrara
lucido
Carrara
marble
polished



MNM*
Nero
marquina
Black
marquina

**La tonalità delle superfici in pietra naturale può variare su ognuno dei pezzi prodotti. / The nuance of the surfaces in natural stone may change on every piece produced.*

Struttura / Frames

Metalli / Metals



VNO
Verniciato
nero
Black
polished

Marnie è una collezione di sedie e tavoli che si contraddistingue per la struttura in frassino che coniuga la solidità del legno alla leggerezza. Merito della particolare lavorazione di sciancratura dei masselli, che rende braccioli e schienali delle sedie e gambe dei tavoli affusolati e dunque visivamente più sottili, come arbusti di un bosco. La sedia, che ha il sedile imbottito, è disponibile anche con schienale imbottito; il tavolo con piano tondo, rettangolare o quadrato, sempre con angoli stondati.

Marnie is a unique collection of chairs and tables with a frame in ashwood, so as to be strong and light at the same time. Armrests and backrests, as well as table legs, are processed by lumps sidecut, so as to result as thin as bushes of a wood. The chair has a padded seat, and is also available with a padded backrest; the table is available with circular, rectangular, or squared top, always with rounded angles.

Designer
Daniele Lo Scalzo Moscheri



Sedie Marnie in frassino naturale con sedile in tessuto Plush; in frassino tinto noce con sedile in tessuto Plush; in frassino tinto nero con sedile e schienale imbottiti in tessuto Plush.

Marnie chairs in natural ash-wood with Plush fabric; in walnut-painted ash-wood with Plush fabric seat; in black painted ash-wood with seat and back upholstered in Plush fabric.

Tavolo Marnie tre gambe in frassino naturale con piano tondo in MDF laccato bianco.
Sedie Marnie in frassino naturale con sedile e schienale imbottiti in tessuto Jojo.
Tappeto Lana, bouclé misto lana e viscosa.

*Three-leg Marnie table in natural ash-wood with round top in MDF white laquered. Marnie chairs in natural ash-wood with seat and back upholstered in Jojo fabric.
Lana rug, bouclé in wool and viscose.*



Tavoli Marnie quattro gambe in frassino tinto noce con piano rettangolare in MDF laccato bianco; quattro gambe in frassino naturale con piano rettangolare in MDF laccato bianco; quattro gambe in frassino tinto nero con piano quadrato in MDF laccato bianco; quattro gambe in frassino naturale con piano quadrato in MDF laccato bianco; tre gambe in frassino tinto noce con piano tondo in MDF laccato bianco.

Marnie tables four-leg version in walnut-painted ash-wood with rectangular top in white lacquered MDF; four-leg version in natural ash-wood with rectangular top in white lacquered MDF; four-leg version in black painted ash-wood with square top in white lacquered MDF; four-leg version in natural ash-wood with square top in white lacquered MDF; three-leg version in walnut-colored ash-wood with round top in white lacquered MDF.



Sedia Marnie in frassino tinto noce con sedile e schienale imbottiti in tessuto Jojo.
Marnie chair in walnut painted ash-wood with seat and back upholstered in Jojo fabric.



Varianti / Versions



A – 2030
 Sedia in frassino a sezione tonda. / *Round section ash chair.*



B – 2031
 Sedia in frassino a sezione tonda con schienale imbottito. / *Round section ash-wood chair with upholstered back.*

Dimensioni / Dimensions

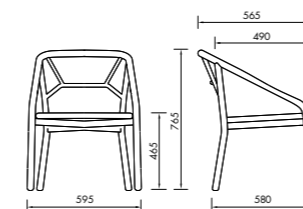

A – B

Struttura / Frames

Legno / Wood



- | | | |
|---|--|---|
| LE11 Frassino naturale Ash | LE12 Frassino tinto noce Ash stained walnut | LE16 Frassino tinto nero Ash stained black |
|---|--|---|

Rivestimenti / Materials

- CAT A Spalmato - Touch
- CAT B Stone Velvet - Origami - Jojo
- CAT C Capri
- CAT D Plush - Velluto Luna
- CAT E Hero
- CAT PE Pelle Miami
- CAT PE1 Pelle Lotus

Marnie

Varianti / Versions



A – 3650

Tavolo 3 gambe in frassino
con piano in MDF laccato sp. 25. /
3-leg ash-wood table with MDF
laquered top th 25.

Dimensioni / Dimensions

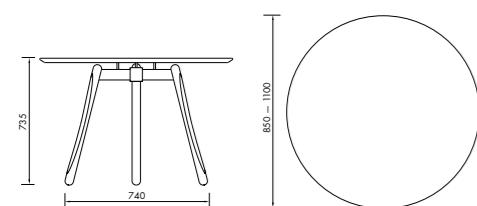

A

Colori piano / Top colors

Mdf / Mdf



LE05B
Laccato bianco
freddo
Cold white
laquered

Struttura / Frames

Legno / Wood



LE11
Frassino
naturale
Ash



LE12
Frassino tinto
noce
Ash stained
walnut



LE16
Frassino tinto
nero
Ash stained
black

Table

Varianti / Versions



B – 3651

Tavolo 4 gambe in frassino
con piano in MDF laccato sp. 25. /
4-leg ash-wood table with MDF
laquered top th 25.



C – 3652 / 3653

Tavolo 4 gambe in frassino
con piano in MDF laccato sp. 25. /
4-leg ash-wood table with MDF
laquered top th 25.

Dimensioni / Dimensions

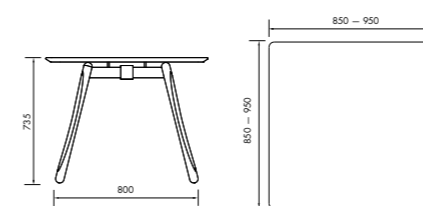

B

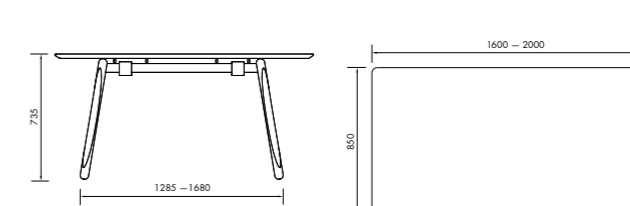

C

Colori piano / Top colors

Mdf / Mdf



LE05B
Laccato bianco
freddo
Cold white
laquered

Struttura / Frames

Legno / Wood



LE11
Frassino
naturale
Ash



LE12
Frassino tinto
noce
Ash stained
walnut



LE16
Frassino tinto
nero
Ash stained
black

Agata è la reinterpretazione della classica poltrona a pozzetto. Morbida e accogliente, è riccamente imbottita e rivestita con tessuti e pelli di pregio. La struttura a vista è in massello di frassino, con gambe che si assottigliano rivelandone l'intrinseca eleganza. Preziosa come la pietra di cui porta il nome, Agata è un esempio di alta artigianalità al servizio della funzionalità e dell'ergonomia.

Agata is the re-interpretation of the classic chair in the cockpit. Soft and comfortable, it is highly upholstered and covered with luxurious fabrics and leathers. The visible frame is in ash-wood, with legs that becomes thinner showing its inner elegance. Precious as the stone that gives it its name, Agata is an example of high craftsmanship at the service of functionality and ergonomics.

Designer
MrSmith Studio

Poltroncine Agata in frassino naturale con seduta in tessuto Tsunami.

Agata armchairs in natural ash-wood seat in Tsunami fabric.



Agata



Armchair

Poltroncine Agata in frassino naturale con seduta in pelle e tavoli Virna in faggio naturale con piano tondo in nobilitato bianco e bordo ABS faggio.

Agata small armchairs in natural ash-wood leather seat and Virna tables in natural beech-wood round top in white melamine with beech-wood ABS edge.





Poltroncine Agata in frassino naturale con sedile e schienale in tessuto *Tsunami*.
Agata armchair with natural ash-wood, seat and back in *Tsunami* fabric.

Varianti / Versions



A – 2020

Poltroncina imbottita in frassino. /
Ash-wood upholstered armchair.

Dimensioni / Dimensions

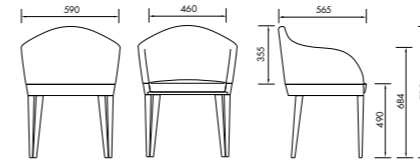

A

Struttura / Frames

Legno / Wood



LE11
Frassino
naturale
Ash



LE12
Frassino tinto
noce
Ash stained
walnut

Rivestimenti / Materials

CAT A Spalmato - Touch
CAT B Stone Velvet - Origami - Jojo
CAT C Capri
CAT D Plush - Velluto Luna
CAT E Hero
CAT PE Pelle Miami
CAT PE1 Pelle Lotus

Lips

Indoor

Dalla combinazione di due elementi curvi, avvolgenti come un guscio, nasce la poltroncina Lips. Una solida struttura in legno curvato accoglie l'imbottitura, rivestita in un'ampia gamma di tessuti, pelli ed ecopelli. Confortevole come una poltroncina, Lips è versatile come una sedia: con gambe in legno, si adatta infatti a qualsiasi contesto – salotto domestico, camera di hotel o sala di un ristorante.

Lips armchair is born from the combination of two curved elements, enveloping like a shell. A solid wood frame in bent wood hosts the upholstery, covered by a wide range of fabrics, faux leather as well as real leather. Extremely comfortable, Lips is as versatile as a chair: with wooden legs, it fits to manifold locations – living rooms, hotel rooms and restaurant halls, too.

Designer
Mario Mazzer

Armchair



Poltrona Lips con gambe e seduta in frassino naturale e rivestimento in ecopelle touch.
Lips armchair with legs and seat in natural and ecoleather touch upholstery.

Poltrone Lips con gambe e seduta in frassino tinto noce e rivestimento in velluto Stone Velvet; con gambe e seduta in frassino naturale e rivestimento in tessuto Jojo; con gambe e seduta in frassino tinto nero e rivestimento in velluto Stone Velvet; con gambe e seduta in frassino naturale e rivestimento in tessuto Jojo.

Lips armchairs with legs and seat in walnut-stained ash-wood and Stone Velvet upholstery; with legs and seat in natural ash-wood and Jojo fabric upholstery; with legs and seat in black painted ash-wood and Stone Velvet upholstery; with legs and seat in natural ash-wood and Jojo fabric upholstery.



Poltrone Lips con gambe e seduta in frassino color noce e rivestimento in tessuto Spalmato. Tavolo Clint con struttura in acciaio calamina e piano in multistrato di frassino color noce.

Lips armchairs with legs and seat walnut stained ashwood and Spalmato fabric upholstery. Clint table with calamine steel structure and walnut ash-wood multilayer top.



Lips

Poltrona Lips con gambe e seduta in frassino naturale e rivestimento in tessuto Jojo.

Lips armchair with seat and back in natural ash-wood, upholstered with Jojo fabric.



Armchair

Varianti / Versions



A – 2070

Poltroncina imbottita con gambe e seduta in frassino. / Upholstered armchair with legs and seat in ash-wood.

Dimensioni / Dimensions

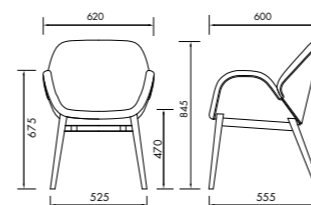

A

Scocca / Shell

Legno / Wood



LE11
Frassino naturale
Ash



LE12
Frassino tinto noce
Ash stained walnut



LE16
Frassino tinto nero
Ash stained black

Struttura / Frames

Legno / Wood



LE11
Frassino naturale
Ash



LE12
Frassino tinto noce
Ash stained walnut



LE16
Frassino tinto nero
Ash stained black

Rivestimenti / Materials

CAT A Spalmato - Touch
CAT B Stone Velvet - Origami - Jojo
CAT C Capri
CAT D Plush - Velluto Luna
CAT E Hero
CAT PE Pelle Miami
CAT PE1 Pelle Lotus

La collezione Amarcord è un omaggio al modernismo. La poltrona ha un design semplice ed essenziale: la seduta, ampia e confortevole, la rende ideale come lounge per sale d'attesa o zone relax. La scocca è disponibile completamente imbottita o in rovere con cuscino imbottito, mentre la base è a slitta in acciaio cromato o verniciato. La poltrona si accompagna all'omonimo tavolino.

Amarcord collection is a tribute to modernism. The armchair has a simple and essential design: the seat, wide and comfortable, makes it suitable as lounge for waiting rooms and relax areas. The seat is available completely upholstered or in oak-wood with a padded pillow, while the cantilever base is in chromed or painted steel. The armchair completes the family with its homonymous table.

Designer
Nicola Cacco

Armchair, coffee table

Poltrona lounge Amarcord con telaio a slitta in acciaio verniciato bianco e scocca rivestita in tessuto King L Kat e tavolino Amarcord con base in acciaio verniciato bianco e piano in MDF laccato bianco.

Amarcord lounge chair with white painted steel cantilever frame and shell upholstered in King L Kat fabric and Amarcord coffee table with white painted steel base and white lacquered MDF top.



Poltrone lounge Amarcord con telaio a slitta in acciaio cromato, scocca in rovere con cuscino o completamente rivestite in lana cotta Hero, tavolini Amarcord con base in acciaio cromato e piano in MDF laccato nero.

Amarcord lounge armchairs with cantilever frame in chromed steel and oak-wood shell with cushion or completely upholstered in Hero boiled wool, Amarcord coffee tables with chromed steel base and top in black lacquered MDF.



Poltrona lounge Amarcord con telaio a slitta in acciaio verniciato nero, scocca in rovere con cuscino rivestito in lana cotta Hero.

Amarcord lounge armchair with cantilever frame in black painted steel and oak-wood shell with cushion upholstered in Hero boiled wool.

Varianti / Versions



A – 2012

Poltrona con base in acciaio e scocca imbottita. / *Armchair with steel base and upholstered shell.*



B – 2011

Poltrona con base in acciaio e scocca in rovere naturale con cuscino imbottito. / *Armchair with steel base and natural oak-wood seat with upholstered cushion.*

Dimensioni / Dimensions

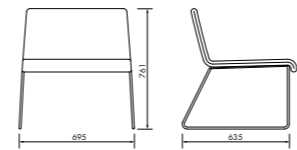

A – B

Seduta / Seat

Legno / Wood



LE01
Rovere
Oak

Struttura / Frames

Metalli / Metals



CR
Cromato
Chromed



VB
Verniciato
bianco
Painted white



VNO
Verniciato
nero
Black
polished

Rivestimenti / Materials

CAT A Spalmato - Touch - Roccia - King L Kat
CAT B Stone Velvet - Origami - Jojo
CAT C Capri
CAT D Plush - Velluto Luna
CAT E Hero
CAT PE Pelle Miami

Amarcord

Varianti / Versions



A – 3060

Tavolino H 256 con piano in MDF laccato opaco. / Coffee table H 256 with MDF top matt lacquered.



B – 3061

Tavolino H 495 con piano in MDF laccato opaco. / Coffee table H 495 with MDF top matt lacquered.

Dimensioni / Dimensions

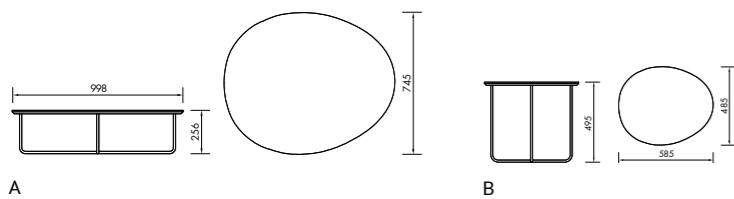

Colori piano / Top colors

Mdf / Mdf



LE05B Laccato bianco / White laquered
LE07 Laccato nero / Black laquered

Struttura / Frames

Metalli / Metals



CR Cromato / Chromed
VB Verniciato bianco / White polished
VNO Verniciato nero / Black polished



Jo Cuoietto

Indoor

Morbida e accogliente, la poltroncina Jo Cuoietto ha un design giocoso dovuto alla particolare bombatura delle gambe e dell'elemento schienale. La sua particolare lavorazione in cuoio, ideale negli spazi indoor sia di luoghi collettivi sia di spazi residenziali, rappresenta la massima espressione dell'artigianalità italiana.

Soft and comfortable, Jo Cuoietto armchair has a fancy design due to its particular legs and backrest crowning. Covered in hard leather, ideal for indoor spaces in both for public and private places, is the best example of our italian handcraft ability.

Designer
Mario Mazzer

Chair

Poltroncina Jo rivestita in cuoio bulgaro e bordeaux.

Jo small armchair in hard leather bulgaro and bordeaux.





Varianti / Versions



A – 2040

Poltroncina in cuoio. / *Armchair in hard leather.*

Dimensioni / Dimensions

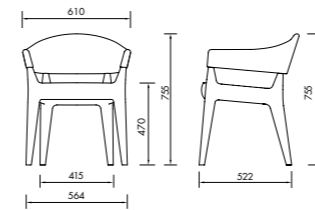

A

Rivestimenti / Materials

Cat CU Cuoio / *Hard leather*

Woodbridge

Indoor

Ispirato all'estetica orientale, che richiama nel design della struttura simile a un ideogramma, Woodbridge è un tavolo in frassino semplice e poetico. È disponibile in due altezze che si accompagnano rispettivamente a sedie o sgabelli. Diverse le finiture disponibili, che danno al tavolo uno stile classico o nordico.

Inspired by the Oriental aesthetics - that recalls in the frame design similar to an ideogram, Woodbridge is a simple and poetic ashwood table. It is available in two heights which match respectively to chairs and stools. Available in different finishes, Woodbridge is a table with a classic or a nordic style.

Designer
Mario Mazzer

Table



Tavolo Woodbridge in frassino tinto noce e poltroncine Agata in frassino tinto noce con seduta in tessuto King L Kat.
Woodbridge table in walnut stained ash-wood and Agata armchairs in walnut stained ash-wood with King L Kat fabric seat.



Woodbridge



Table

Tavolo Woodbridge altezza sgabello in frassino naturale.
Woodbridge stool height version in natural ash-wood.



Tavolo Woodbridge altezza sgabello in frassino tinto nero.
Woodbridge stool height version in black painted ash-wood.



Woodbridge



Il piede del tavolo è ottenuto con un elegante incrocio del frassino massello in sezione tonda.

Foot detail of Woodbridge table, created with an elegant intersection between round shape massive ash-wood elements.

Table

Varianti / Versions



A – 3720H7

Tavolo in frassino H 750 con piano in multistrato dai bordi massellati sp. 40. / Ash-wood table H 750, with multilayer top with solid wood edges th 40.



B – 3720H1

Tavolo in frassino H 1100 con piano in multistrato dai bordi massellati sp. 40. / Ash-wood table H 1100, with multilayer top with solid wood edges th 40.

Dimensioni / Dimensions

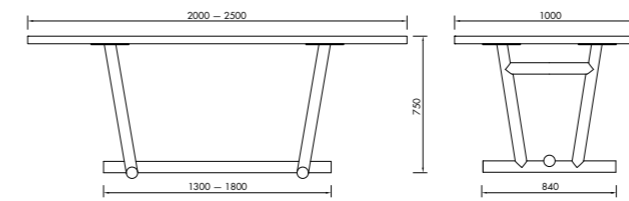

A

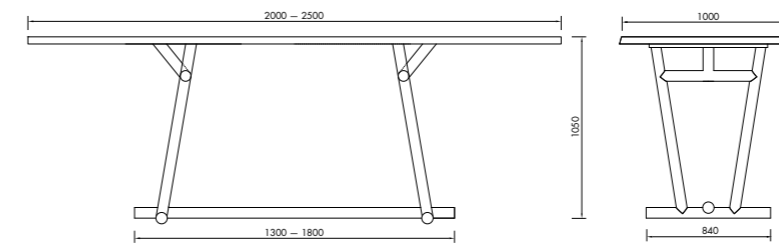

B

Colori piano / Top Colors

Legno / Wood



LE11
Frassino naturale
Ash

LE12
Frassino tinto noce
Ash stained walnut

LE16
Frassino tinto nero
Ash stained black

Struttura / Frames

Legno / Wood



LE11
Frassino naturale
Ash

LE12
Frassino tinto noce
Ash stained walnut

LE16
Frassino tinto nero
Ash stained black

Paloalto

Indoor
Outdoor

Paloalto è un tavolo che unisce le radici di Alma a un'idea di design contemporaneo. La struttura è composta da due tubi curvati, uniti a terra da due piedi d'acciaio, che sostengono il piano in legno in finitura rovere naturale o scuro. Disponibile in due altezze, si usa come tavolo conviviale o in modo più informale e dinamico. La versione con piano in abete termotrattato è adatta anche per gli ambienti outdoor.

Paloalto is a table conveying Alma's roots to an idea of contemporary design. Its frame is made of two bent tubes, combined on the ground by two steel feet which sustain the wooden top in natural or dark oak finish. Available in two heights, it can be used as meal table or in a more informal way. The version with pine wood top thermotreated is suitable for outdoors, too.

Designer
Mario Mazzer

Table

Tavolo Paloalto con struttura in acciaio verniciato bianco e piano in frassino naturale.

Paloalto table with white painted steel structure and top in natural ash-wood.



Paloalto è visibile anche a pag. 190. / Paloalto is also available at p.190.

Tavolo Paloalto con struttura in acciaio verniciato antracite e piano in frassino tinto noce.

Paloalto table with anthracite painted steel structure and top in walnut-stained ash-wood.



Varianti / Versions



A – 3730H7

Tavolo H 750 con struttura in tubo d'acciaio e piano in frassino o abete disponibile in tre dimensioni. / *Table H 750 with steel tube structure and ash - or fir - wood top, available in three sizes.*



B – 3730H1

Tavolo H 1100 con struttura in tubo d'acciaio e piano in frassino o abete disponibile in tre dimensioni. / *Table H 1100 with steel tube structure and ash - or fir - wood top, available in three sizes.*

Dimensioni / Dimensions

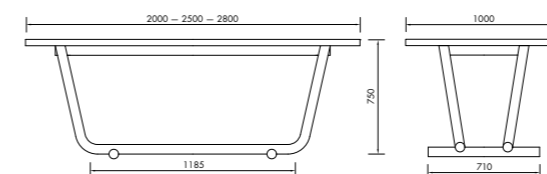

A

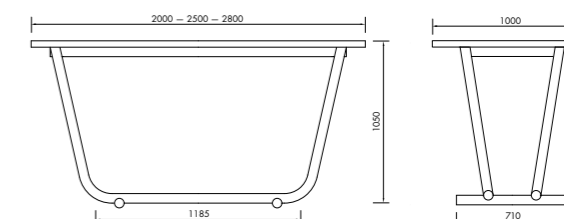

B

Colori piano / Top colors

Laminato nobilitato / *Laminated melamine*



B Bianco / White
C Grigio chiaro / Light grey
N Nero / Black
T Antracite / Anthracite

Legno / Wood



CA Abete termotrattato / Thermotreated pine
LE11 Frassino naturale / Ash
LE12 Frassino tinto noce / Ash stained walnut
LE16 Frassino tinto nero / Ash stained black

Struttura / Frames

Metalli / *Metals*



VB Verniciato bianco / White painted
VT Verniciato antracite / Anthracite painted

Clint

Ispirato alla cultura e all'estetica orientali, il tavolo Clint ricorda nella struttura un grande origami d'acciaio. Un volume forte e geometrico, bilanciato dalla presenza del piano in legno. Scultoreo e moderno, il tavolo Clint è disponibile in varie dimensioni, finiture e nella versione allungabile.

Indoor

Inspired by Oriental culture and aesthetic, Clint frame recalls a big origami made of steel. Its strong and geometrical shape is balanced by the presence of the wooden top. Sculptural and modern, Clint is available in various sizes, finishes and in the extendable version.

Designer
Mario Mazzer

Table

Tavolo Clint multistrato di frassino tinto nero.

Clint table with structure in calamine steel and top in black stained ash plywood.



Clint è visibile anche a pag. 84. / Clint is also available at p. 84.

Clint

Tavolo Clint con struttura in acciaio
calamina e piano laminato tinta noce
con meccanismo allungabile in alluminio.
Tappeto Lana, misto lana e viscosa.

*Clint extendable table with structure in
calamine steel and top in walnut laminated.
Lana rug, bouclé in wool and viscose.*

Table



Clint



Tavolo Clint con struttura in acciaio verniciato nero e piano in multistrato di frassino tinto nero.

Clint table with structure in black painted steel and top in black stained multilayer top.

Table

Varianti / Versions



A - 3700

Tavolo in acciaio, piede 890, piano con bordi massellati sp. 40. / Steel table, foot 890, multilayer top with solid wood edges, th 40.



B - 3701

Tavolo in acciaio, piede 650, piano con bordi massellati sp. 40. / Steel table, foot 650, multilayer top with solid wood edges, th 40.



C - 3702

Tavolo allungabile in acciaio, piede 650, piano in laminato da 1400+500+500x900 con bordo sp.70. / Extendable steel frame table, foot 650, laminated top dimension 1400+500+500x900, edge th 70.

Dimensioni / Dimensions

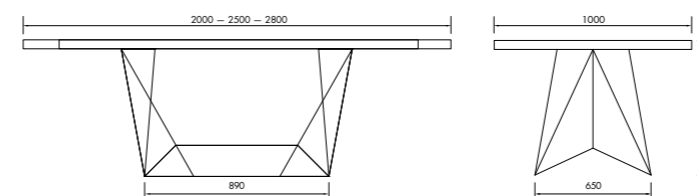

A

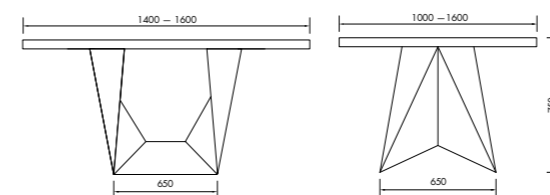

B

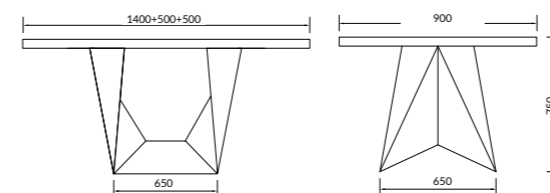

C

Struttura / Frames

Metalli / Metals



CE
Calamina
Calamine



VB
Verniciato
bianco
White
painted



VNO
Verniciato
nero
Black painted

Colori piano / Top colors

Legno / Wood



LE11
Frassino
naturale
Natural ash



LE12
Frassino tinto
noce
Ash stained
walnut



LE16
Frassino tinto
nero
Ash stained
black

Laminato / Laminated



LN*
Laminato noce
Walnut
laminated



LNC*
Laminato nero
carbone
Black coal
laminated



LP*
Laminato pietra
Stone
laminated

*Solo per versione allungabile / Only for extendable version

X è una collezione ampia e multiforme, in continua evoluzione. Disegnata da Mario Mazzer a partire da un segno a forma di X che ricorre nel design, si distingue per la qualità dei materiali. La collezione comprende la poltroncina Y, dalle linee morbide e raccolte, e la poltrona X Big, entrambe con base in legno o acciaio per l'uso domestico e contract oppure girevole a razze per l'ufficio; il divano due o tre posti; la sedia X chair e lo sgabello X stool; tavoli e tavolini di diverse altezze con struttura in legno o acciaio e piano laccato oppure interamente in legno.

X is a wide and various collection in continuous evolution. Designed by Mario Mazzer starting from the simple X sign - that often recurs in the collection - X stands out for its materials quality. This collection comprehends the Y chair with soft and simple lines, and the X Big armchair; both with a wooden or steel base for private and contract places, it is also available in the swivel version with legs suitable for the office world; the X collection also includes a two - or three - seat sofa; X chair and X stool; tables and service tables of various heights, with wooden or steel frame and lacquered top or entirely in wood.

Designer
Mario Mazzer

Poltrona X Big con base in frassino naturale, seduta e poggiatesta in tessuto Plush con comoda maniglia in cuoio per facilitare il movimento. X Pouf con base in frassino naturale e seduta in tessuto Plush. Tavolino X Table con struttura in frassino naturale e piano in MDF laccato bianco.

X Big armchair with base in natural ash-wood and headrest in Plush fabric with convenient hard leather handle to facilitate seat handling. X Pouf with base in natural ash-wood and seat in Plush fabric. X Table coffee table with structure in natural ash-wood top in white lacquered MDF.





Armchair, coffee table, sofa

Poltrona X Big con poggiatesta con base in acciaio verniciato bianco e seduta in tessuto Jojo. Poltrona X Big con base girevole quattro razze in alluminio e seduta bicolore in tessuto Jojo.

X Big armchair with headrest with steel base and seat in Jojo fabric. X Big armchair with four-leg swivel base in aluminium and bicolor seat in Jojo fabric.

Tavolini X Table con struttura in frassino naturale e piano in MDF laccato bianco; con struttura in metallo verniciato antracite e piano in laminato antracite; con struttura e piano in frassino tinto nero.

X Table coffee tables with structure in natural ash-wood and white lacquered MDF top; with anthracite painted steel structure and anthracite laminate top; with structure and top in black stained ash-wood.



X Collection



Armchair, coffee table, sofa

Poltrona X Big con base in frassino tinto nero e seduta in tessuto Plush. Tavolino X Table con struttura e piano in frassino tinto nero. Divano X Big Too a due posti con struttura in frassino tinto nero e seduta in tessuto Plush.

X Big armchair with base in black-stained ash-wood and seat in Plush fabric. X coffee table with structure and top in black stained ash-wood. X Big Too two-seat sofa with black stained ash structure and Plush fabric seat.



Poltroncine Y con gambe in metallo conico verniciato sabbia e seduta in tessuto Roccia.
Tavoli X Table con struttura in acciaio verniciato sabbia e piano in laminato bianco.
Y Armchair with sand painted conical metal legs and Roccia fabric seat. X Table with sand painted steel structure and white laminate top.



Poltroncine Y con base girevole quattro razze in alluminio e seduta in lana cotta Hero; con gambe in frassino naturale e seduta in lana cotta Hero; con gambe in metallo a sezione rettangolare verniciato antracite e seduta in lana cotta Hero; con base cinque razze in verniciato nero opaco con ruote e seduta in lana cotta Hero.

Y Armchair with four-star swivel base in aluminum and seat in Hero boiled wool; with legs in natural ash-wood and seat in Hero boiled wool; with legs in anthracite painted rectangular steel tube and seat in Hero boiled wool; with five-star aluminum base with wheels and seat in Hero boiled wool.



X Collection



128

Chair

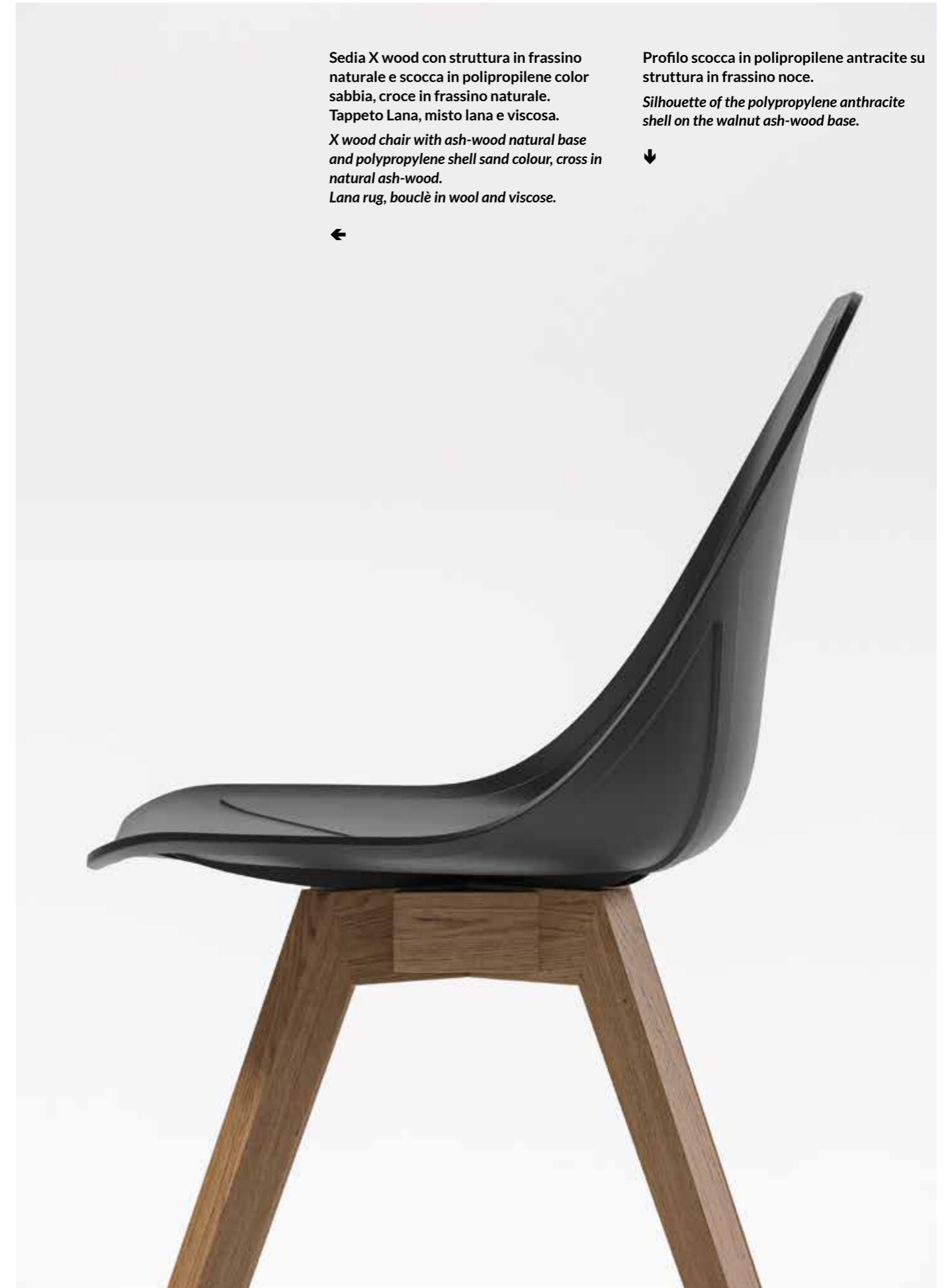

129



Sedia X wood con struttura in frassino noce e scocca in polipropilene color antracite, croce in frassino noce; sedia X spider con struttura in metallo sezione rettangolare verniciata antracite, scocca e croce in polipropilene antracite.

X wood chair with ash-wood natural base and polypropylene shell sand colour, cross in natural ash-wood; X spider chair with rectangular tube base, anthracite painted, shell and cross in polypropylene anthracite colour.



Particolare della croce in frassino noce sul sedile.
Detail of the ash-wood walnut cross on the seat.





Sgabello X wood con struttura in frassino naturale e scocca in polipropilene color bianco, croce in frassino naturale; sgabello X spider con struttura in metallo sezione rettangolare verniciata sabbia, scocca e croce in polipropilene sabbia.

X wood stool with ash-wood natural base and polypropylene shell white colour, cross in natural ash-wood; X spider stool with rectangular tube base, sand painted, shell and cross in polypropylene sand colour.



A – 1082

Sedia 4 gambe tubo rettangolo in acciaio verniciato con scocca in polipropilene (X Spider). / 4-legs rectangular steel tube painted chair with polypropylene shell (X Spider).



B – 1083

Sedia 4 gambe in frassino con scocca in polipropilene (X Wood). / 4-legs ash wood frame with polypropylene shell (X Wood).

Dimensioni / Dimensions

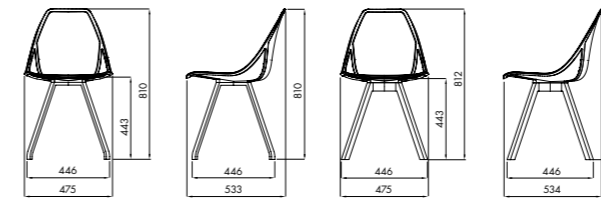

A

B

Scocca / Shell

Polipropilene / Polypropylene



A
Antracite
Anthracite

B
Bianco
White

S
Sabbia
Sand

Struttura / Frames

Metalli / Metals



CR
Cromato
Chromed

VA
Verniciato
alluminio
Aluminium
painted

VB
Verniciato
bianco
White painted

VS
Verniciato
sabbia
Sand painted

VT
Verniciato
antracite
Anthracite
painted

Legno / Wood



LE11
Frassino
naturale
Ash

LE12
Frassino tinto
noce
Ash stained
walnut

LE16
Frassino tinto
nero
Ash stained
black

Rivestimenti / Materials

CAT A Spalmato - Touch - Roccia - King L Kat
CAT B Stone Velvet - Jojo
CAT D Velluto Luna

X Stool

Varianti / Versions



C – 4061 - 4064

Sgabello 4 gambe tubo rettangolare con scocca in polipropilene H 750/650 (X Spider). / 4-legs rectangular tube stool with polypropylene shell H 750/650 (X Spider).



D – 4062 - 4065

Sgabello 4 gambe in frassino con scocca in polipropilene H 760/650 (X Wood). / 4-legs ash wood frame stool with polypropylene shell H 760/650 (X Wood).

Dimensioni / Dimensions

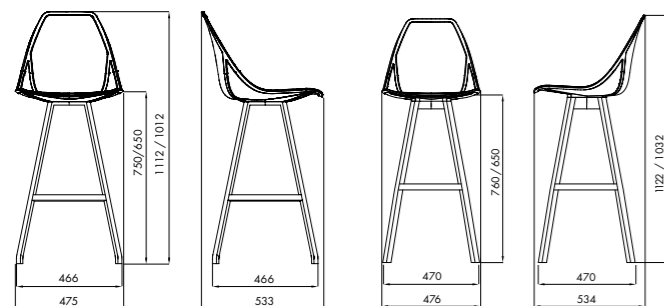

C

D

Scocca / Shell

Polipropilene / Polypropylene



A Antracite
Anthracite

B Bianco
White

S Sabbia
Sand

Struttura / Frames

Metalli / Metals



CR Cromato
Chromed

VA Verniciato alluminio
Aluminium painted

VB Verniciato bianco
White painted

VS Verniciato sabbia
Sand painted

VT Verniciato antracite
Anthracite painted

Legno / Wood



LE11 Frassino naturale
Ash

LE12 Frassino tinto noce
Ash stained walnut

LE16 Frassino tinto nero
Ash stained black

Rivestimenti / Materials

CAT A Spalmato - Touch - Roccia - King L Kat
CAT B Stone Velvet - Jojo
CAT C Capri
CAT D Velluto Luna

X Beam



E – 5082

Panca in acciaio verniciato a 2 posti con scocche in polipropilene. / 2 Places bench with painted steel frame and polypropylene seats.



F – 5083

Panca in acciaio verniciato a 3 posti con scocche in polipropilene. / 3 Places bench with painted steel frame and polypropylene seats.



G – 5084

Panca in acciaio verniciato a 4 posti con scocche in polipropilene. / 4 Places bench with painted steel frame and polypropylene seats.

Dimensioni / Dimensions

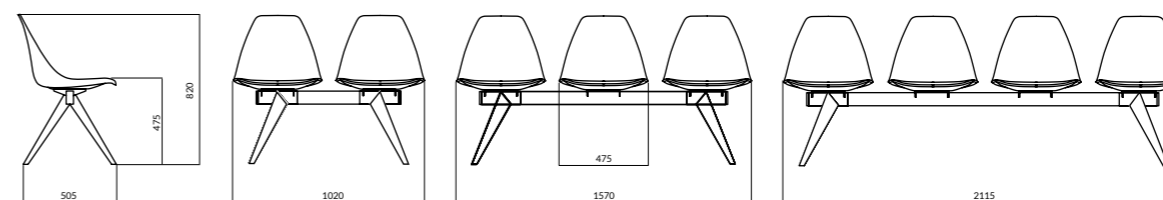

E

F

G

Scocca / Shell

Polipropilene / Polypropylene



A Antracite
Anthracite

B Bianco
White

S Sabbia
Sand

Struttura / Frames

Metalli / Metals



VA Verniciato alluminio
Aluminium painted

VB Verniciato bianco
White painted

VT Verniciato antracite
Anthracite painted

Rivestimenti / Materials

CAT A Spalmato - Touch - Roccia - King L Kat
CAT B Stone Velvet - Jojo
CAT D Velluto Luna

X Big

Varianti / Versions



A – 2050
Poltrona con base in frassino. /
Lounge armchair in ash-wood.



B – 2051
Poltrona con base in acciaio
verniciato a sezione rettangolare. /
Armchair with base in painted
rectangular steel tube.



C – 2053
Poltrona con base girevole 4 razze
in alluminio. / 4-star swivel lounge
armchair upholstered.

Dimensioni / Dimensions

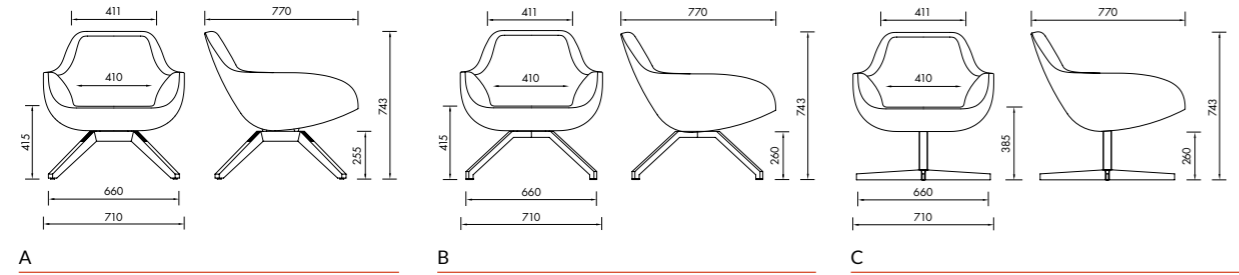

X 2Big



A – 2054
Poltrona con poggiatesta e base in
frassino. / Lounge armchair in ash-
wood with headrest.



B – 2055
Poltrona con poggiatesta e base
in acciaio verniciato a sezione
rettangolare. / Armchair with base
in painted rectangular steel tube
with headrest.



C – 2057
Poltrona con poggiatesta e base
girevole 4 razze in alluminio. /
4-star swivel lounge armchair
upholstered with headrest.

Dimensioni / Dimensions

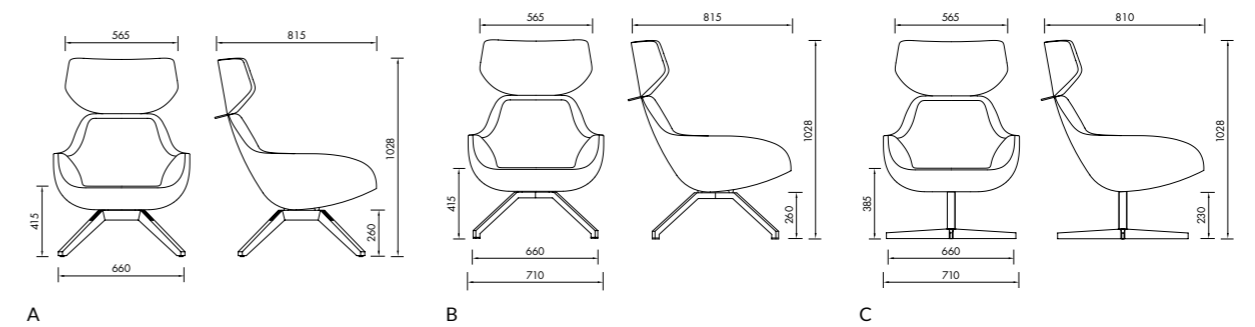

Struttura / Frames

Metalli / Metals



VB Verniciato bianco / White painted
VS Verniciato sabbia / Sand painted
VT Verniciato antracite / Anthracite painted

Alluminio / Aluminum



AU 09* Lucido / Polished

Legno / Wood



LE11 Frassino naturale / Ash
LE12 Frassino tinto noce / Ash stained walnut
LE16 Frassino tinto nero / Ash stained black

Rivestimenti / Materials

CAT A Spalmato - Touch - Roccia - King L Kat
CAT B Stone Velvet - Origami - Jojo
CAT C Capri
CAT D Plush - Velluto Luna
CAT E Hero
CAT PE Pelle Miami
CAT PE1 Pelle Lotus

Struttura / Frames

Metalli / Metals



VB Verniciato bianco / White painted
VS Verniciato sabbia / Sand painted
VT Verniciato antracite / Anthracite painted

Alluminio / Aluminum



AU 09* Lucido / Polished

Legno / Wood



LE11 Frassino naturale / Ash
LE12 Frassino tinto noce / Ash stained walnut
LE16 Frassino tinto nero / Ash stained black

Rivestimenti / Materials

CAT A Spalmato - Touch - Roccia - King L Kat
CAT B Stone Velvet - Origami - Jojo
CAT C Capri
CAT D Plush - Velluto Luna
CAT E Hero
CAT PE Pelle Miami
CAT PE1 Pelle Lotus

X Big Too

Varianti / Versions



A – 7012P
Divano 2 posti con base in frassino tinto. / *Sofà with ash wood stained 2-seat frame.*



B – 7013P
Divano 3 posti con base in frassino tinto. / *Sofà with ash wood stained 3-seat frame.*

Dimensioni / Dimensions

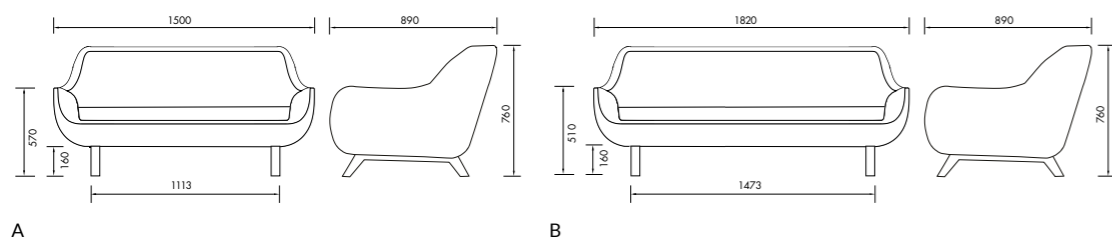

A

B

Struttura / Frames

Legno / Wood



LE11 Frassino naturale / Ash
LE12 Frassino tinto noce / Ash stained walnut
LE16 Frassino tinto nero / Ash stained black

Rivestimenti / Materials

CAT A Spalmato - Touch - Roccia - King L Kat
CAT B Stone Velvet - Origami
CAT C Capri
CAT D Plush - Velluto Luna
CAT E Hero
CAT PE Pelle Miami
CAT PE1 Pelle Lotus

X Pouf

Varianti / Versions



A – 2080
Poltrona senza schienale con struttura in frassino e sedile imbottito. / *Armchair without back with ash wood base and upholstered seat.*



B – 2081
Poltrona senza schienale con struttura in acciaio verniciato sezione rettangolare e sedile imbottito. / *Armchair without back with painted steel frame with rectangular shape and upholstered seat.*



C – 2083
Poltrona senza schienale con struttura a 4 razze in alluminio girevole e sedile imbottito. / *Armchair without back with swivel 4 stars aluminum frame and upholstered seat.*

Dimensioni / Dimensions

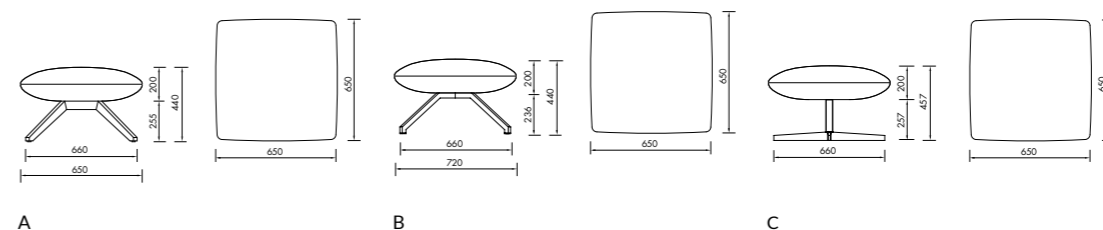

A

B

C

Struttura / Frames

Metalli / Metals



VB Verniciato bianco / White painted
VS Verniciato sabbia / Sand painted
VT Verniciato antracite / Anthracite painted

Alluminio / Aluminum



AU 09* Lucido / Polished
*Solo per 2083 / Only for 2083

Legno / Wood



LE11 Frassino naturale / Ash
LE12 Frassino tinto noce / Ash stained walnut
LE16 Frassino tinto nero / Ash stained black

Rivestimenti / Materials

CAT A Spalmato - Touch - Roccia - King L Kat
CAT B Stone Velvet - Origami
CAT C Capri
CAT D Plush - Velluto Luna
CAT E Hero
CAT PE Pelle Miami

X Big Foot

Varianti / Versions



A – 7020

Poggiapiedi con struttura in frassino e sedile imbottito. / Foot rest with ash wood base and upholstered seat.

Dimensioni / Dimensions

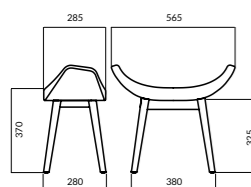

A

Struttura / Frames

Legno / Wood



LE11 Frassino naturale / Ash
LE12 Frassino tinto noce / Ash stained walnut
LE16 Frassino tinto nero / Ash stained black

Rivestimenti / Materials

CAT A Spalmato - Touch - Roccia - King L Kat
CAT B Stone Velvet - Origami - Jojo
CAT C Capri
CAT D Plush - Velluto Luna
CAT E Hero
CAT PE Pelle Miami

Y Armchair

Varianti / Versions



A – 2090

Poltroncina impilabile 4 gambe in acciaio verniciato con scocca in polietilene o imbottita. / Stackable 4-leg armchair in painted steel with polyethylene or upholstered shell.



B – 2091

Poltroncina 4 gambe tubo rettangolare con scocca in polietilene o imbottita. / 4-leg armchair with rectangular tube and polyethylene or upholstered shell.



C – 2092

Poltroncina 4 gambe in frassino con scocca in polietilene o imbottita. / 4-leg armchair in ash-wood with polyethylene or upholstered shell.



D – 2095

Poltroncina 4 gambe tubo conico con scocca in polietilene o imbottita. / 4-leg armchair with conical tube and polyethylene or upholstered shell.

Dimensioni / Dimensions

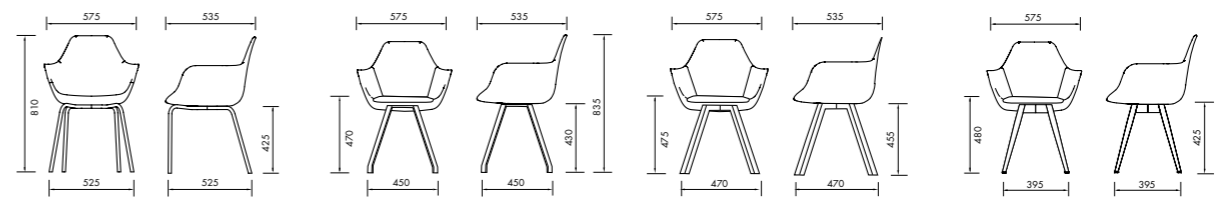

A

B

C

D

Scocca / Shell

Polietilene / Polyethylene



A Antracite / Anthracite
B Bianco / White
GA Giallo ambra / Amber yellow
RC Rosso ciliegia / Cherry red
S Sabbia / Sand
VB Verde bosco / Dark green

Struttura / Frames

Metalli / Metals



VA Verniciato alluminio / Aluminium painted
VB Verniciato bianco / White painted
VS Verniciato sabbia / Sand painted
VT Verniciato antracite / Anthracite painted

Legno / Wood



LE11 Frassino naturale / Ash
LE12 Frassino tinto noce / Ash stained walnut
LE16 Frassino tinto nero / Ash stained black

Rivestimenti / Materials

CAT A Spalmato - Touch - Roccia - King L Kat
CAT B Stone Velvet - Origami - Jojo
CAT C Capri
CAT D Plush - Velluto Luna
CAT E Hero
CAT PE Pelle Miami

Y Armchair

Varianti / Versions



E – 2096

Poltroncina girevole 4 razze in alluminio con scocca in polietilene o imbottita. / 4-leg swivel armchair in aluminum with polyethylene or upholstered shell.



F – 2097

Poltroncina girevole 4 razze in alluminio con ruote piroettanti e scocca in polietilene o imbottita. Regolabile in altezza con meccanismo a gas. / Swivel armchair with 4 stars base in aluminum with swivel wheels and polyethylene or upholstered shell. Adjustable height with gas system.



G – 2098

Poltroncina girevole 5 razze in alluminio con ruote piroettanti e scocca in polietilene o imbottita. Regolabile in altezza con meccanismo a gas. / Swivel armchair with 5 stars base in aluminum with swivel wheels and polyethylene or upholstered shell. Adjustable height with gas system.

Dimensioni / Dimensions

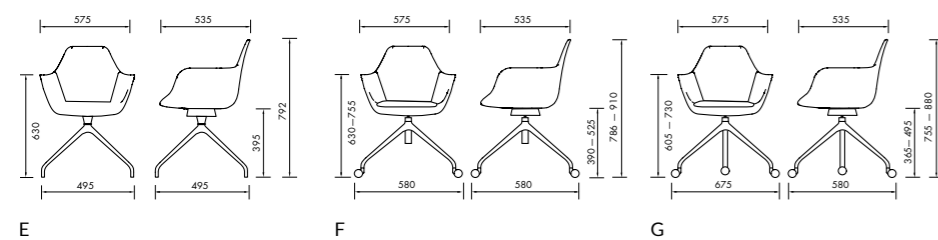

Scocca / Shell

Polietilene / Polyethylene



A Antracite Anthracite
B Bianco White
GA Giallo ambra Amber yellow
RC Rosso ciliegia Cherry red
S Sabbia Sand
VB Verde bosco Dark green

Struttura / Frames

Alluminio / Aluminum



AU 09 Lucido Polished
VNO Verniciato nero Black painted

Rivestimenti / Materials

CAT A Spalmato - Touch - Roccia - King L Kat
CAT B Stone Velvet - Origami - Jojo
CAT C Capri
CAT D Plush - Velluto Luna
CAT E Hero
CAT PE Pelle Miami

X Table

Varianti / Versions



A – 3670

Tavolino H 455 in frassino o acciaio laccato con piano in MDF laccato opaco o frassino verniciato. / Coffee table H 455 in ash-wood or painted steel with top in matt lacquered MDF or painted ash-wood.



B – 3671

Tavolino H 290 in frassino o acciaio verniciato con piano in MDF laccato opaco o frassino verniciato. / Coffee table H 290 in ash-wood or painted steel with top in matt lacquered MDF or painted ash-wood.



C – 3672

Tavolo H 740 in acciaio verniciato con piano in MDF laccato opaco o frassino verniciato o laminato. / Table H 740 in painted steel with top in matt lacquered MDF or painted ash-wood or laminate.

Dimensioni / Dimensions

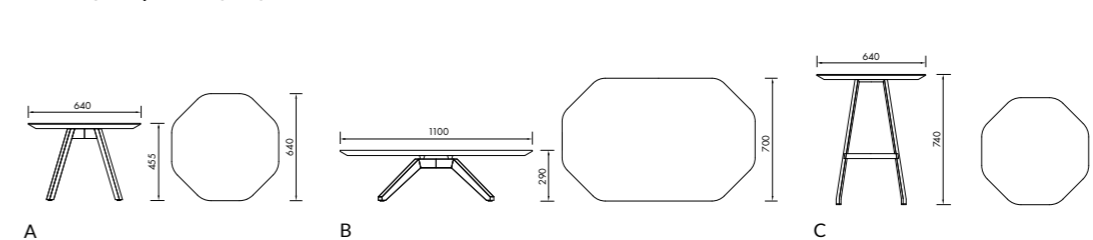

Colori piano / Top colors

Mdf / Mdf



LE05B Laccato bianco freddo White laquered
LE18 Laccato sabbia Sand laquered
LE19 Laccato antracite Anthracite laquered

Laminato nobilitato / Laminated melamine



B Bianco White
C Grigio chiaro Light grey
N Nero Black
T Antracite Anthracite

Legno / Wood



LE11 Frassino naturale Ash
LE12 Frassino tinto noce Ash stained walnut
LE16 Frassino tinto nero Ash stained black

Struttura / Frames

Metalli / Metals



VB Verniciato bianco White painted
VS Verniciato sabbia Sand painted
VT Verniciato antracite Anthracite painted

Legno / Wood



LE11 Frassino naturale Ash
LE12 Frassino color noce Ash stained walnut
LE16 Frassino tinto nero Ash stained black

Semplicità è una parola chiave per il design di Alma. Valerio Sommella ne offre la sua interpretazione con Amy, sedia dalla grande personalità che unisce forme armoniose a linee dinamiche. Realizzata in polipropilene con tecnologia air moulding, è disponibile con o senza braccioli, anche con cuscino sedile per un maggior comfort. Perfetta per i luoghi del contract per le sue caratteristiche di leggerezza, impilabilità e resistenza ai raggi UV per uso indoor e outdoor, Amy trova collocazione anche negli spazi domestici.

Simplicity is the key word for Alma's design. Valerio Sommella offers his interpretation with Amy, a chair characterized by high personality, harmonious shapes, and dynamic lines. Made of polypropylene injected by air moulding technology, it is available both with or without armrest, also with a pillow seat for a better comfort. Perfect for contract places thanks to its lightness, stackability, and resistance to UV ray to indoor and outdoor use, Amy is suitable for home places, too.

Designer
Valerio Sommella



Poltroncina Amy in polipropilene verde bosco con cuscino sedile in tessuto Roccia.
Amy armchair in dark green polypropylene with seat cushion in Roccia fabric.

Amy

Chair

Sedie Amy in polipropilene rosso mattone.
Tavoli Mojito con struttura in metallo
verniciato antracite e piano in HPL nero.
*Amy chairs in brick red polypropylene. Mojito
tables with anthracite painted metal structure
and black HPL top.*





Sedia Amy in polipropilene antracite e poltroncina Amy in polipropilene giallo ambra.
Amy chair in anthracite polypropylene and Amy armchair in yellow amber polypropylene.



Sedia Amy in polipropilene bianco e sabbia.
Amy chair in white and sand polypropylene.

Chair

Varianti / Versions



A – 1090

Sedia impilabile in polipropilene colorato. / Stackable chair in colored polypropylene.



B – 1091

Poltroncina impilabile in polipropilene colorato. / Stackable armchair in colored polypropylene.

Dimensioni / Dimensions

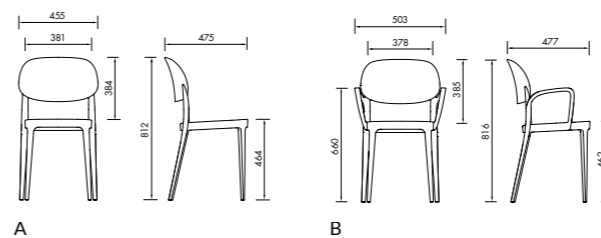

A

B

Seduta / Seat

Polipropilene / Polypropylene

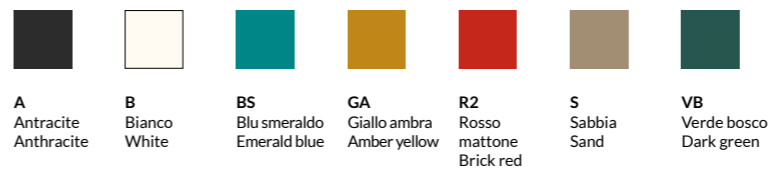

Rivestimenti / Materials

CAT A Spalmato - Touch - Roccia - King L. Kat

Julie

Indoor
Outdoor

Julie unisce linee essenziali che rievocano il design delle sedie del passato a un materiale attualissimo, il polipropilene stampato con la tecnologia air moulding. Resistente ai raggi UV, leggera, impilabile e disponibile in tanti colori diversi, Julie è ideale per tutti i contesti del contract, indoor e outdoor. La versione con cuscino sedile aggiunge un tocco di comfort, rendendola ideale anche per l'ambiente domestico.

Julie combines essential lines recalling ancient chairs design together with an extremely modern material: gas injected polypropylene, UV-resistant, light weight, stackable, and available in many different colours, Julie is ideal for any type of contract setting, both indoor and outdoor. The pillow version adds a touch of comfort, making it suitable for a home place too.

Designer
Tria.De design + Valérie Galli

Chair



Sedia Julie in polipropilene blu viola.
Julie chair in violet blue polypropylene.

Julie è visibile anche a pag. 221. / Julie visible also at p. 221.

Sedie Julie in polipropilene cipria.
Tavoli Ciak in alluminio verniciato bianco
con piano ribaltabile tondo in lamiera
verniciata bianco.

*Julie chairs in powder pink polypropylene.
Ciak tables in white painted aluminum with
round white painted steel top, folding.*



Sedia Julie in polipropilene rosso ciliegia con cuscino sedile in ecopelle Touch e sedia Julie in polipropilene nero con cuscino in ecopelle Touch.

Julie chair cherry red polypropylene with cushion in eco leather Touch and Julie chair in black polypropylene with cushion in eco leather Touch.



Julie

Chair

Sedia Julie in polipropilene bianco e sabbia.
Julie chair in white and sand polypropylene.



158

159

Julie

Sedia Julie in polipropilene color rosso ciliegia, senza cuscino e con cuscino in ecopelle Touch.

Julie chair in cherry red polypropylene, without cushion and with Touch eco-leather cushion.



Chair

Varianti / Versions



A – 1070

Sedia impilabile in polipropilene colorato. / *Stackable chair in colored polypropylene.*

Dimensioni / Dimensions

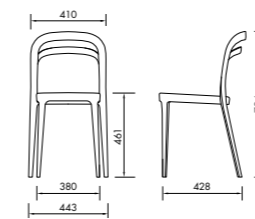

A

Seduta / Seat

Polipropilene / Polypropylene



B
Bianco
White



BV
Blu viola
Violet blue



C
Cipria
Powder pink



N
Nero
Black



RC
Rosso ciliegia
Cherry red



S
Sabbia
Sand

Rivestimenti / Materials

CAT A Spalmato - Touch - Roccia - King L Kat

Marlene

Indoor
Outdoor

La classica sedia in legno rinasce in versione contemporanea. Marlene riprende le linee delle sedie da bistrot, ma le reinterpreta grazie al policarbonato brillante e al nylon lucido, due materiali che riverberano la luce. Realizzata con tecnologia air moulding, Marlene è resistente ai raggi UV e perfettamente impilabile, motivo per cui è particolarmente adatta all'interno e all'esterno di bar e ristoranti, oltre che negli ambienti domestici.

The classic wood chair is born again in a contemporary version. Marlene resumes lines from bistrot, but it reinterprets them thanks to bright polycarbonate and polished nylon, both materials do spread light. Produced by air moulding technology, Marlene is UV-resistant and stackable, this is the reason why it is particularly suitable for interior and exterior spaces of cafés and restaurants, as well as for home places.

Designer
JF Smith

Chair

Sedia Marlene in nylon lucido bianco e in policarbonato trasparente.

Marlene chair, in shiny white nylon and transparent polycarbonate.



Sedie Marlene in nylon nero lucido;
in policarbonato fumé; in policarbonato
rosso.

*Marlene chairs in black polished nylon;
fumé polycarbonate; in red polycarbonate.*

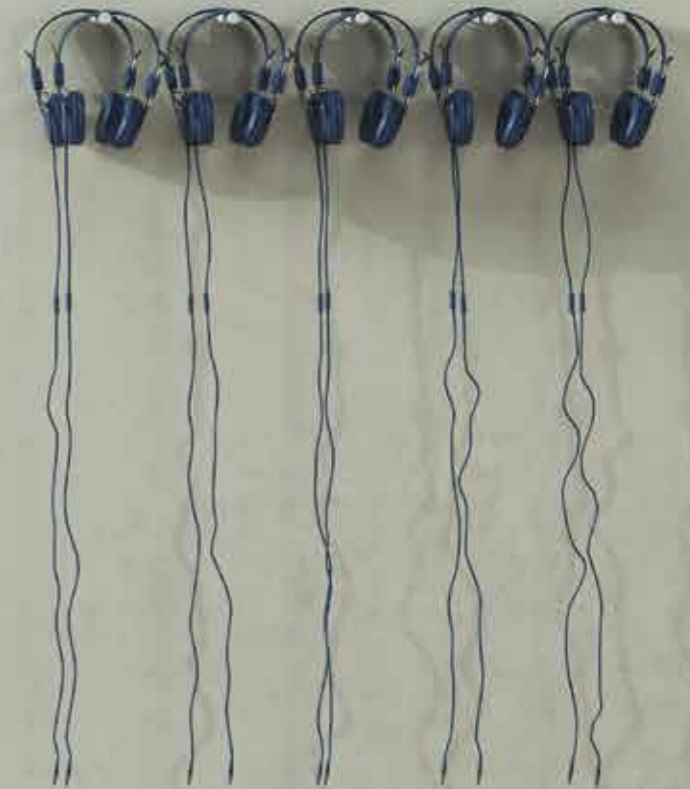

Marlene

Sedie Marlene in nylon rosso pompeiano lucido.
Tavolo Bistrò tre gambe in acciaio verniciato
rosso e piano tondo in HPL rosso.

*Marlene chairs in shiny Pompeian red nylon.
Three-leg Bistrò Table in red painted steel and round
top in red HPL.*



Chair

Sedie Marlene in nylon rosso pompeiano
lucido.

Marlene chairs in shiny Pompeian red nylon.



Marlene

Sedia Marlene in policarbonato giallo.
Marlene chair in yellow polycarbonate.



Chair

Varianti / Versions



A – 1050

Sedia in nylon lucido. /
Chair in shining nylon.



B – 1051

Sedia in policarbonato trasparente. /
Chair in transparent polycarbonate.

Dimensioni / Dimensions

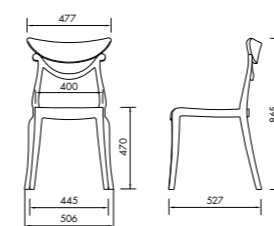

A – B

Seduta / Seat

Nylon / Nylon



B
Bianco lucido
White
polished



N
Nero lucido
Black
polished



RP
Rosso pompeiano
Lucido
Pompeian red
polished

Policarbonato / Polycarbonate



F
Fumé
Fumé



RT
Rosso
Red



T
Trasparente
Transparent



YT
Giallo
Yellow

Rivestimenti / Materials

CAT A Spalmato - Touch
CAT B Stone Velvet - Jojo
CAT D Velluto Luna

Bistrò

Bistrò è un tavolo in acciaio verniciato dalle linee sinuose ispirate al design di inizio Novecento che rievoca nel nome le caffetterie francesi. E proprio negli spazi dell'horeca si trova infatti a suo agio, sia all'interno che all'esterno. Bistrò è disponibile con piano tondo o quadrato, a tre o quattro gambe.

Bistrò is a painted steel table with sinuous lines inspired by the design of the early 900s that evokes through its name the French cafés. It is exactly in the horeca places that it fits in, both indoor and outdoor. Bistrò is available with a circle or squared top, with three or four legs.

Designer
Alma

Table

Tavolo Bistrò con telaio quattro gambe in acciaio verniciato rosso e piano in HPL rosso.

Bistrò table with a four-leg frame in red painted steel and top in red HPL.



Bistrò è visibile anche a pag. 166. / Bistrò visible also at p. 166.

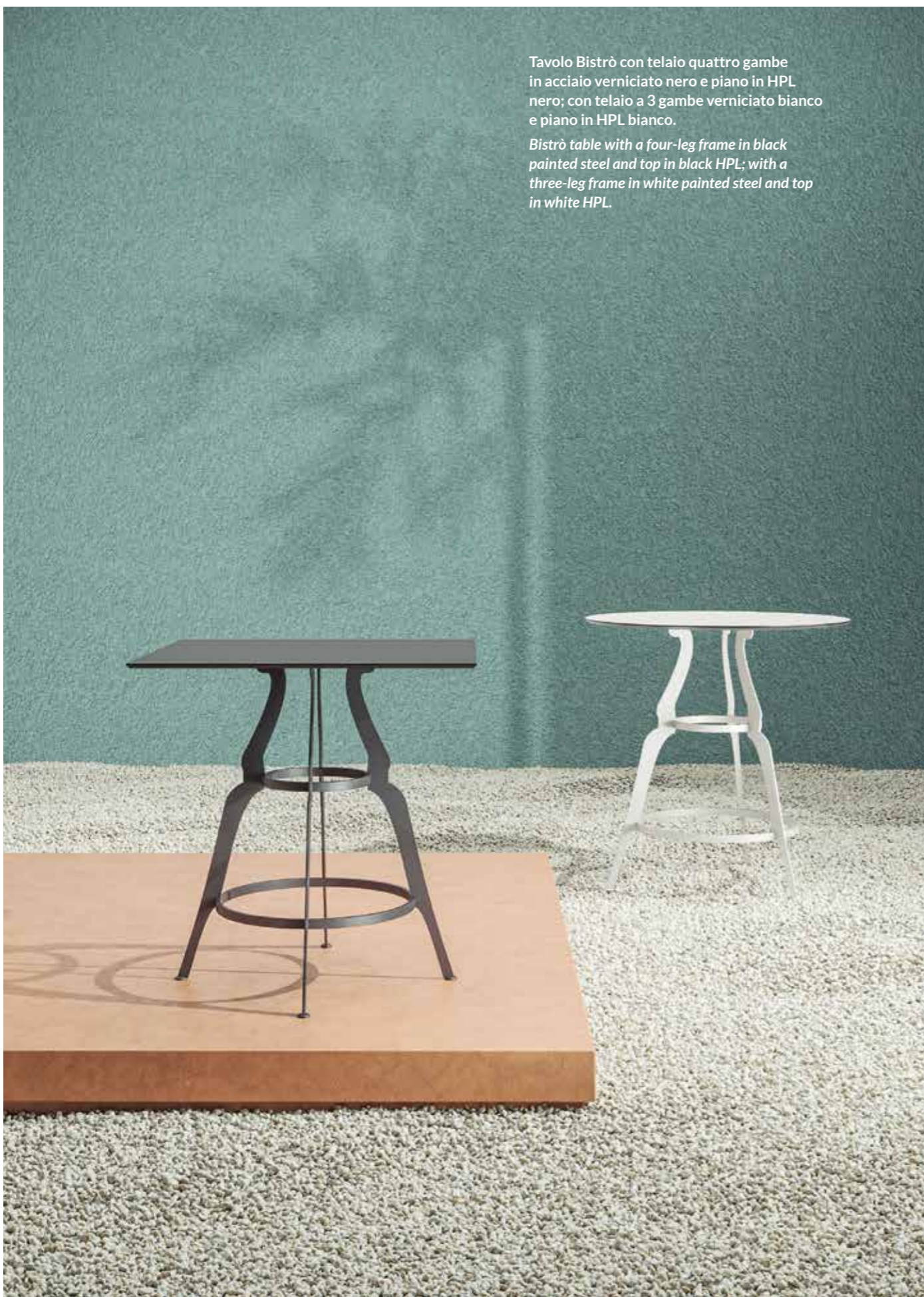

Tavolo Bistrò con telaio quattro gambe in acciaio verniciato nero e piano in HPL nero; con telaio a 3 gambe verniciato bianco e piano in HPL bianco.

Bistrò table with a four-leg frame in black painted steel and top in black HPL; with a three-leg frame in white painted steel and top in white HPL.

Varianti / Versions



A – 3070

Tavolo con telaio 3 gambe in acciaio verniciato e piano in HPL. / *Table with a 3-leg frame in painted steel and top in HPL.*



B – 3071

Tavolo con telaio 4 gambe in acciaio verniciato e piano in HPL. / *Table with a 4-leg frame in painted steel and top in HPL.*

Dimensioni / Dimensions

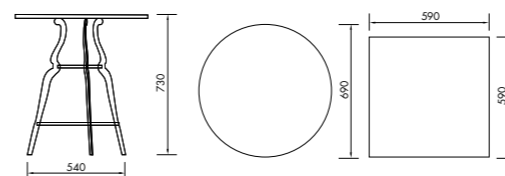

A

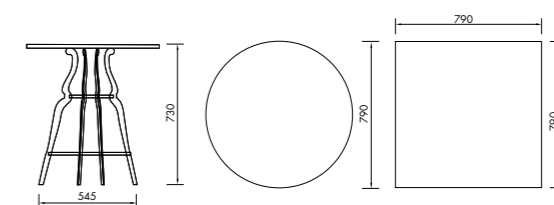

B

Colori piano / Top Colors

Resina / Resine



B
Bianco
White

N
Nero
Black

Laminato nobilitato / Laminated melamine



B
Bianco opaco
Matt white

N
Nero opaco
Matt black

Solid core / Solid core



HB
Bianco
White

Hpl / Hpl



HB
Bianco
White

HN
Nero
Black

HR
Rosso
Red

Struttura / Frames

Metalli / Metals



VB
Verniciato
bianco
White painted

VNO
Verniciato
nero
Black painted

VR
Verniciato
rosso opaco
Red matt
painted

Meg

Indoor
Outdoor

Suggerimenti vintage per la poltrona Meg, seduta monoscocca dalle forme monolitiche. Realizzata in polietilene, Meg è ideale per arredare terrazzi e giardini: attuale e contemporanea, confortevole e ironica, è realizzata con materiali riciclabili.

Vintage charm for our Meg armchair, a single seat with monolithic lines. Made of polyethylene, Meg is ideal to furnish terraces and gardens: a modern and contemporary product made in recyclable materials, it results to be extremely comfortable and fancy.

Designer
Mario Mazzer

Armchair



Poltrona Meg in polietilene bianco.
Meg armchair in white polyethylene.

Poltrone Meg in polietilene verde bosco e tavolini Pepper in polietilene giallo ambra.

Meg armchairs in dark green polyethylene and Pepper coffee tables in amber yellow polyethylene.





Poltrone Meg in polietilene colori cipria, antracite, rosso ciliegia e sabbia.

Armchair Meg in polyethylene color pink powder, anthracite, cherry red and sand.

Varianti / Versions



A – 2060

Poltroncina in polietilene colorato. / Colored polyethylene armchair.



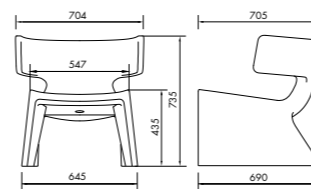



Dimensioni / Dimensions



A

Seduta / Seat

Polietilene / Polyethylene

| | | | | | | |
|---|---|---|---|---|---|---|
|  |  |  |  |  |  |  |
| A Antracite Anthracite | B Bianco White | BX Viola bordeaux Violet bordeaux | C Cipria Powder pink | RC Rosso ciliegia Cherry red | S Sabbia Sand | VB Verde bosco Dark green |

Pepper

Indoor
Outdoor

Pepper è un elemento d'arredo eclettico e polifunzionale, da interpretare in libertà in base ai contesti e alle esigenze. Pratico tavolino di servizio, diventa uno sgabello informale, ma anche una lampada da esterni nella versione dotata di illuminazione. Realizzato in polietilene in un'ampia gamma di colori – dal rosso peperone che dà il nome alla collezione alle tonalità più neutre – si usa sia indoor che outdoor. Pepper è disponibile anche nella versione imbottita per diventare una comoda seduta.

Pepper is an eclectic and multifunctional furniture element, freely interpretable according to contexts and needs. It is a multitasking product. Practical service table, it becomes an informal stool but also an outdoor lamp in the illuminated version. Made of polyethylene in a range of different colours – from pepper red which gives the name to the collection to more neutral shades – it is suitable both for indoors and outdoors. Pepper is also available in an upholstered version to be used as a comfortable seat.

Designer
Mario Mazzer

Coffee table

Tavolini Pepper in polietilene rosso ciliegia e in polietilene con luce.
Pepper coffee tables in cherry red polyethylene and polyethylene with light.



Pepper è visibile anche a pag. 176. / Pepper visible also at p. 176.

Pepper

Pouf

Pepper imbottito con ecopelle Touch.
Pepper upholstered with ecoleather Touch.



Pepper

Pepper colori: giallo ambra, sabbia, rosso ciliegia, viola bordeaux, bianco, antracite e a terra verde bosco.

Pepper colours: amber yellow, sand, cherry red, violet bordeaux, white, anthracite and on the floor dark green.



Coffee table, pouf

Varianti / Versions



A – 3680

Tavolino H 450 in polietilene colorato. / Coloured polyethylene table H 450.



B – 3681

Tavolino H 450 in polietilene con luce. / Polyethylene table H 450 with light.



C – 3682

Sgabello H 450 rivestito. / Upholstered stool H 450.

Dimensioni / Dimensions

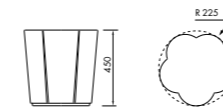

A – B – C

Scocca / Shell

Polietilene / Polyethylene



Colori cavi / Cablecolor

Per interno / Indoor: cotone rosso - trasparente / red cotton - transparent
Per esterno / Outdoor: nero IP44 / black IP44

Rivestimenti / Materials

CAT A Spalmato - Touch - King L Kat



Indoor
Outdoor

Morbida e accogliente, la poltroncina Jo ha un design giocoso dovuto alla particolare bombatura delle gambe e dell'elemento schienale. La versione in polietilene, declinata anche nel formato dello sgabello, stampata in rotomoulding, è ideale negli spazi indoor e outdoor sia di luoghi collettivi sia di spazi residenziali.

Soft and comfortable, Jo armchair has a fancy design due to its particular legs and backrest crowning. The polyethylene version, also available in stool version, injected in rotomoulding, is ideal for indoors and outdoors, both for public and private places.

Designer
Mario Mazzer

Chair



Poltroncina Jo in polietilene giallo ambra e in polietilene verde bosco.

Jo small armchair in yellow amber polyethylene and in dark green polyethylene.

Sgabelli Jo in polietilene bianco. Tavolo Mojito alto in alluminio verniciato bianco, piano tondo in HPL bianco.

Jo stools in white polyethylene. Mojito table in white painted aluminium and HPL round top.



Poltroncina Jo in polietilene antracite,
sedile e schienale in ecopelle Touch.
Tavolo Paloalto in acciaio verniciato
antracite e piano in abete termotrattato.

*Jo small armchair in anthracite polyethylene,
seat and back upholstered in Touch ecoleather
Paloalto table steel anthracite painted frame
and top in thermotreated pine.*



Poltroncina Jo in polietilene color sabbia.
Jo small armchair in sand polyethylene.

Chair, Stool

Varianti / Versions



A – 2040
Poltroncina in polietilene colorato. /
Coloured polyethylene little armchair.



B – 4070
Sgabello in polietilene colorato. /
Coloured polyethylene stool.



C – 2041
Poltroncina in polietilene colorato
con sedile e schienale imbottiti. /
Coloured polyethylene little armchair
with seat and back upholstered.

Dimensioni / Dimensions

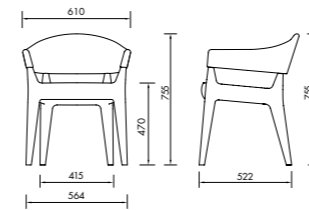

A - C

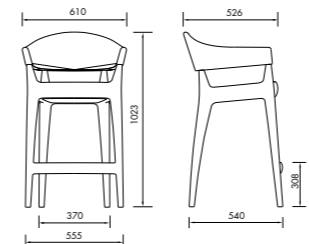

B

Seduta / Seat

Polietilene / Polyethylene



A Antracite
B Bianco
GA Giallo ambra
Amber yellow
RC Rosso ciliegia
Cherry red
S Sabbia
Sand
VB Verde bosco
Dark green

Rivestimenti / Materials

CAT A Spalmato - Touch - Roccia - King L. Kat

2525 è uno sgabello monoblocco a forma di cono, reso ancora più leggero dalle rientranze che lo fanno assomigliare ai numeri 2 e 5, a seconda di come viene girato. Pratico e impilabile, disponibile in due misure, è progettato per rispondere alle esigenze di bar e ristoranti, che lo usano sia all'interno sia all'esterno, ma anche a quelle di uno spazio domestico, dove rappresenta un'ottima soluzione salvaspazio.

2525 is a single cone-shaped stool, made even lighter thanks to the recesses making it similar to the numbers 2 and 5, according to how it is placed. Practical and stackable, available in two sizes, it has been designed to answer to the needs of bars and restaurants, both for indoor and outdoor use; it can be placed also in private spaces, representing a perfect space-saving solution.

Designer
Sergio Mori



Sgabelli 2525 bassi in polietilene arancio e rosso ciliegia. Tavolo Ice Table con basamento in polietilene nero e piano in polipropilene nero.

2525 low stool in orange polyethylene and in cherry red polyethylene. Ice Table with black polyethylene base and black polypropylene top.



Sgabelli 2525 impilabili in polietilene color sabbia.

2525 stools, stackable, in sand polypropylene.

Varianti / Versions



A – 4051

Sgabello H 465 in polietilene colorato. / Coloured polyethylene low stool H 465.



B – 4050

Sgabello H 750 in polietilene colorato. / Coloured polyethylene stool H 750.

Dimensioni / Dimensions



A



B

Seduta / Seat

Polietilene / Polyethylene



A
Antracite
Anthracite



B
Bianco
White



O
Arancio
Orange



RC
Rosso ciliegia
Cherry red



S
Sabbia
Sand

Anouk

Anouk è uno sgabello essenziale che unisce alla base in metallo cromato una seduta che evoca una piccola onda. Si personalizza scegliendo tra sedile in legno multistrato, sedile completamente imbottito o sedile imbottito con legno a vista.

Anouk is an essential stool matching the chromed metal base with a seat recalling a little wave. It can be personalized by choosing between the multilayer wooden seat, the completely padded seat, or a padded seat with visible wood.

Designer
Nicola Cacco

Indoor

Stool

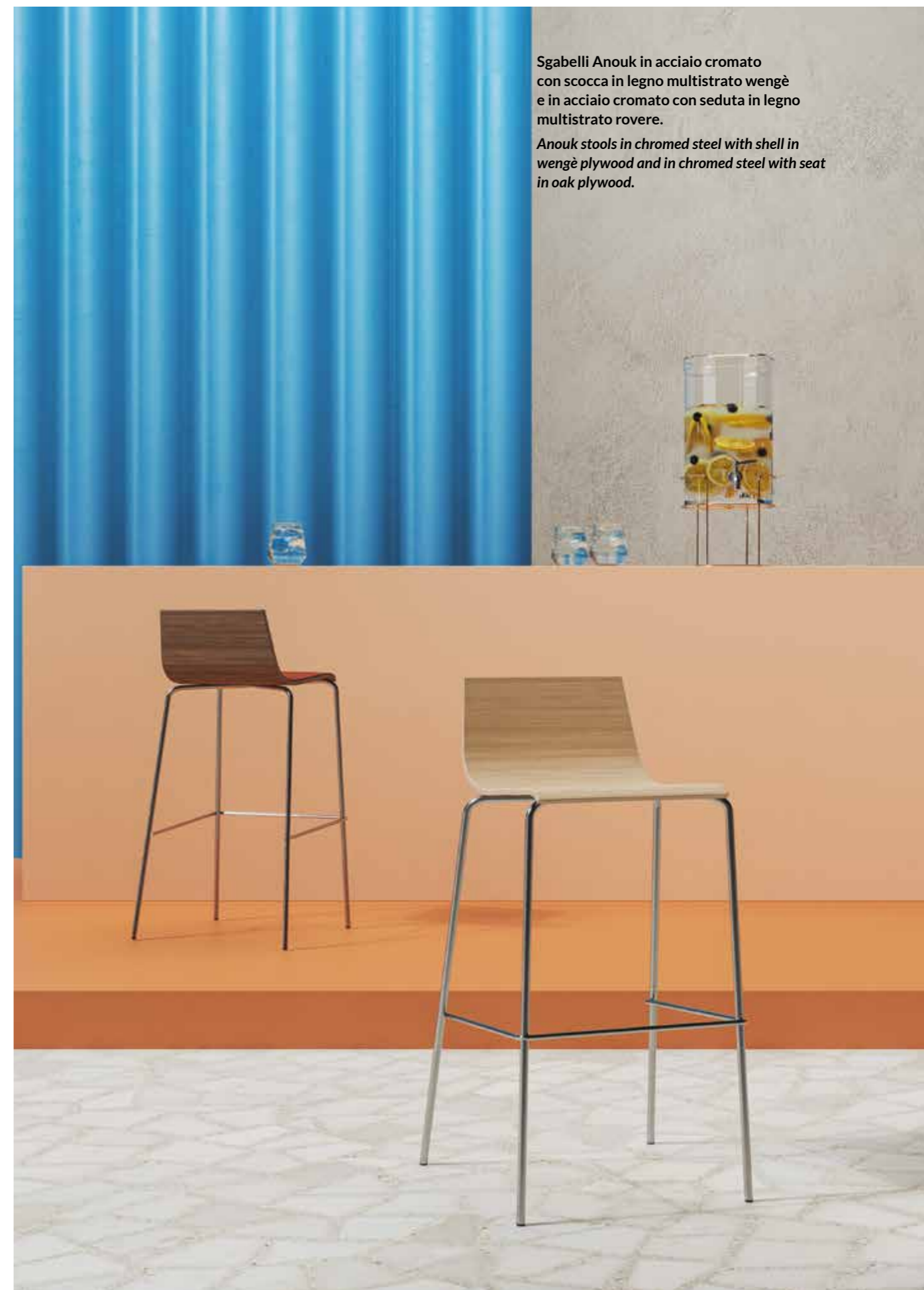

Sgabelli Anouk in acciaio cromato con scocca in legno multistrato wengè e in acciaio cromato con seduta in legno multistrato rovere.

Anouk stools in chromed steel with shell in wengè plywood and in chromed steel with seat in oak plywood.

Anouk

Sgabelli Anouk in acciaio verniciato nero e scocca in ecopelle Touch. Tavolo People alto in acciaio verniciato nero con piano in laminato nero.

Anouk stools in painted black steel with upholstered seat in Touch ecoleather. People table high version black painted steel and top in black laminate.

Stool



200

201

Sgabello Anouk con struttura in acciaio verniciato nero, scocca in multistrato rovere con cuscino in ecopelle Touch.

Anouk stool in painted black steel structure, shell in oak plywood and cushion in Touch ecoleather.



Varianti / Versions



A – 4030

Sgabello impilabile con base cromata o verniciata e scocca in multistrato di faggio. / *Stackable stool with chromed or painted base and beech plywood shell.*



A – 4030

Sgabello impilabile con base cromata o verniciata e scocca in multistrato di faggio in versione imbottita. / *Stackable stool with chromed or painted base and beech plywood shell in the upholstered version.*



A – 4030 +CS403

Sgabello impilabile con base cromata o verniciata e scocca in multistrato di faggio in versione con cuscino. / *Stackable stool with chromed or painted base and beech plywood shell in version with cushion.*

Dimensioni / Dimensions

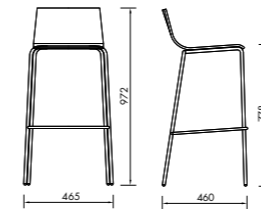

A

Seduta / Seat

Legno / Wood



LE01
Rovere
Oak



LE03
Wengè
Wengè

Struttura / Frames

Metalli / Metals



CR
Cromato
Chromed



VNO
Verniciato
nero
Black painted

Rivestimenti / Materials

CAT A Spalmato - Touch - Roccia - King L Kat
CAT B Stone Velvet - Origami - Jojo
CAT C Capri
CAT D Plush - Velluto Luna
CAT E Hero
CAT PE Pelle Miami

Primo prodotto firmato Alma nel 2008, Estrosa ne rappresenta da allora una sorta di manifesto. Realizzata in estruso di alluminio anodizzato, unisce un design essenziale a una trasversalità che la rende adatta a qualsiasi contesto. Benché ispirato al processo produttivo di estrusione, il nome allude anche all'originalità "estrosa" del profilo di sedile e schienale.

First product designed by Alma in 2008, since then Estrosa represents a sort of symbol. Made of extruded anodised aluminium, it combines an essential design with a transversality that makes it suitable for any context. Even if inspired by the extrusion production process, its name also recalls the fancy originality of the seat and backrest profile.

Designer
Setacomincini

Sedia e sgabello Estrosa con telaio a slitta e struttura in acciaio verniciato nero, sedile e schienale in alluminio anodizzato nero.

Estrosa chair and stool with cantilever frame and structure in black painted steel, seat and back in black anodized aluminum.



Sedie Estrosa con telaio a 4 gambe e struttura in acciaio verniciato alluminio, sedile e schienale in alluminio anodizzato colore grigio. Tavoli People con base in acciaio verniciato bianco e piano quadrato in nobilitato bianco.

Estrosa chairs with 4-leg frame and structure in aluminum painted steel, seat and back in anodized aluminum grey color. People tables with base in white painted steel and square top in white melamine.



Schienale sedia Estrosa in estruso di alluminio anodizzato nero.

Estrosa back of the chair, extruded aluminium with black anodization.



Varianti / Versions



A – 1010

Sedia con struttura a slitta in acciaio, sedile e schienale in alluminio estruso e anodizzato. / Chair with steel cantilever structure, seat and back in extruded and anodized aluminium.



B – 1011

Sedia con struttura a 4 gambe in acciaio, sedile e schienale in alluminio estruso e anodizzato. / Chair with a 4-leg steel frame, seat and back in extruded and anodized aluminium.

Varianti / Versions



C – 4020 / 4021

Sgabello con struttura a slitta in acciaio e sedile in alluminio estruso e anodizzato. / Stool with steel cantilever frame and seat in extruded and anodized aluminium.



D – 5020

Panca a 2 posti con struttura in acciaio e sedile in alluminio estruso e anodizzato. / 2 seats bench with steel frame, seat in extruded and anodized aluminium.

Dimensioni / Dimensions

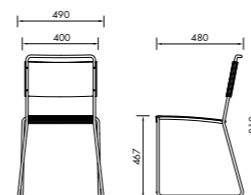

A

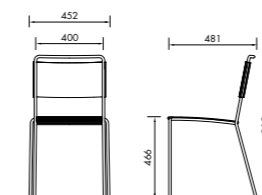

B

Dimensioni / Dimensions

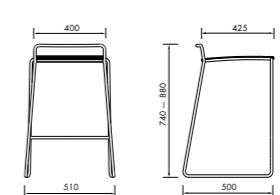

C

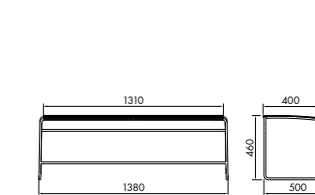

D

Seduta / Seat

Alluminio / Aluminium



AU01
Nero
Black

AU02
Grigio
Grey

Struttura / Frames

Metalli / Metals



CR
Cromato
Chromed

VA
Verniciato
alluminio
Aluminium
painted

VNO
Verniciato
nero
Black painted

Edward

La versatilità di Edward risiede nella sua semplicità. Un tavolo passe-partout adatto a essere interpretato in diversi contesti a seconda delle finiture scelte per il piano e la struttura in acciaio, dal ristorante al soggiorno di casa, dalla mensa aziendale alla biblioteca.

The versatility of Edward lies in its simplicity. A passe-partout table suitable to fit in different settings according to the finishes chosen for the top and the steel frame; it is suitable for restaurants and home living rooms, for corporate canteens as well as libraries.

Designer
Alma

Table

Tavoli Edward 800x1800 e 800x300 con struttura e gambe in acciaio verniciato nero e piano in nobilitato olmo grigio scuro.
Edward tables 800x1800 and 800x300 with structure and legs in black painted steel and top in dark grey melamine.





Sedie Estrosa con telaio a 4 gambe e struttura in acciaio verniciato nero, sedile e schienale in alluminio anodizzato colore nero. Tavolo Edward con base in acciaio verniciato nero e piano in nobilitato nero.

Estrosa chairs with 4-leg frame and structure in black painted steel, seat and back in anodized aluminium black color. Edward tables with base in black painted steel and top in black melamine.

Varianti / Versions



A – 3030

Tavolo H 725 - 715 in acciaio con piano sp. 20 in laminato opaco o nobilitato o sp. 10 in HPL o solid core. / Table H 725 - 715 in steel with top th. 20 in matt or melamine laminate or th. 10 in HPL or solid core.



B – 3030S

Tavolo H 725 - 715 servetto in acciaio con piano sp. 20 in laminato opaco o nobilitato o sp. 10 in HPL o solid core. / Dessert table H 725 - 715 in steel with top th. 20 in matt laminate or melamine or th. 10 in HPL or solid core.

Dimensioni / Dimensions

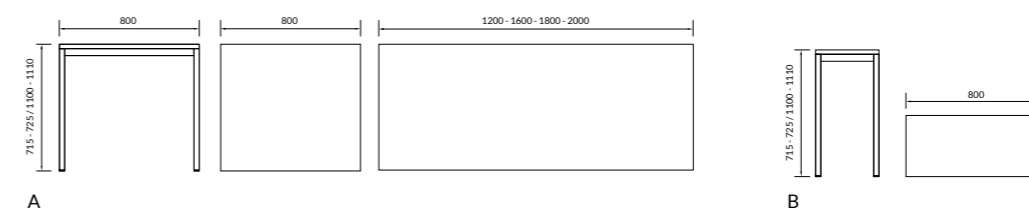

Colori piano / Top colors

Hpl / Hpl



HB
Bianco
White

HL
Alluminio
Aluminium

HN
Nero
Black

HS
Sabbia
Sand

Solid core / Solid core



HB
Bianco
White

Laminato nobilitato / Laminated melamine



B
Bianco
White

C
Grigio chiaro
Light grey

N
Nero
Black

T
Antracite
Anthracite

Struttura / Frames

Metalli / Metals



CR
Cromato
Chromed

VA
Verniciato
alluminio
Aluminium
painted

VB
Verniciato
bianco
White
painted

VNO
Verniciato nero
Black
painted

Virna

Virna è una collezione di tavoli disegnata da Mario Mazzer. La struttura è in faggio, con gambe leggermente più sottili alle estremità. Per le sue forme semplici e le proporzioni armoniche, Virna si adatta a qualsiasi ambiente.

Virna is a collection of tables designed by Mario Mazzer. The frame is made of beech wood with legs that are slightly thinner at the edge. Thanks to its simple shapes and its harmonious proportions, Virna fits in any location.

Designer
Mario Mazzer

Table

Tavolo Virna in faggio naturale con piano tondo in laminato bianco.
Virna table in natural beech with round top in white laminate.



Virna è visibile anche a pag. 76. / *Virna visible also at p. 76.*

Tavoli Virna in faggio naturale con piano quadrato in laminato grigio chiaro; in faggio color noce con piano rettangolare in laminato tortora; in faggio naturale con piano tondo in laminato bianco; in faggio nero con piano tondo in laminato nero.

Virna tables in natural beech with square top in light grey laminate; in walnut beech with rectangular top in taupe laminate; in natural beech with round top in white laminate; in black beech with round top in black laminate.





Tavolo Virna in faggio naturale con piano rettangolare in laminato bianco. Poltroncine Y con struttura in acciaio conico verniciato bianco e seduta in lana cotta Hero.

Virna table in natural beech-wood with rectangular top in white laminate. Y Armchair with white painted conical steel structure and boiled wool Hero seat.

Table

Varianti / Versions



A – 3712H7

Tavolo H 750 in faggio con piano rettangolare in laminato o in altri materiali. / Rectangular table H 750 in beech-wood with laminate top or other materials.



B – 3710H7 / 3711H7

Tavolo H 750 in faggio con piano quadrato o tondo in laminato o in altri materiali. / Square or round table H 750 in beech-wood with top in laminate or other materials.



C – 3710H1

Tavolo H 1100 in faggio con piano quadrato o tondo in laminato o in altri materiali. / Square or round table H 1100 in beech-wood with top in laminate or other materials.

Dimensioni / Dimensions

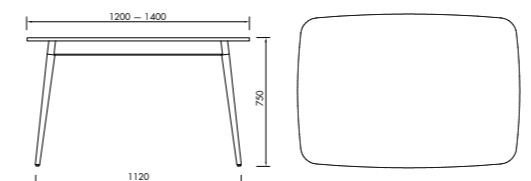

A

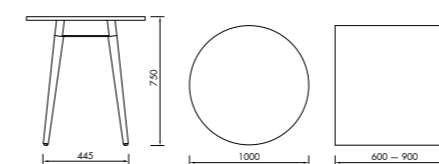

B

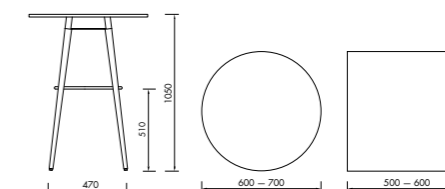

C

Colori piano / Top colors

Laminato nobilitato / Laminated melamine



Hpl / Hpl

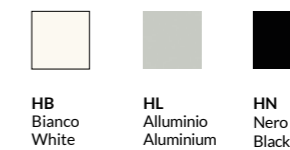

Struttura / Frame

Legno / Wood

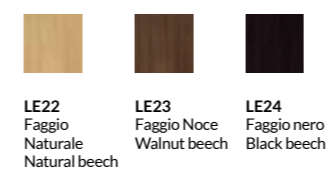

Malèna

Ispirazione vintage, realizzazione contemporanea. Malèna è un tavolo in acciaio caratterizzato dalla doppia base con profilo conico, la cui forma è ottenuta con particolari lavorazioni di tornitura. Molteplici le versioni del piano, con profilo smussato a 45°.

Indoor

Vintage inspiration, contemporary production. Malèna is a steel table characterized by a double base with a cone profile, its shape is obtained by a particular turning process. There are manyfold versions of the top, with a 45° beveled edge.

Designer
Alma

Table

Tavolo Malèna in acciaio verniciato bianco con piano quadrato in laminato bianco con bordo in MDF laccato. Sedie Julie in polipropilene rosso ciliegia.

Malèna table in white painted steel with square top in white laminate with laquered MDF edge. Julie chairs in cherry red polypropylene.



Tavoli Malèna con due basi in acciaio verniciato nero opaco con piano rettangolare in laminato nero con bordo in MDF laccato; in acciaio verniciato bianco con piano tondo in laminato bianco con bordo in MDF laccato; in acciaio verniciato nero con piano quadrato in laminato nero con bordo in MDF laccato; in acciaio verniciato bianco con piano quadrato in laminato bianco con bordo in MDF laccato.

Malèna tables with two bases in matt black painted steel with rectangular top in black laminate with laquered MDF edge; in white painted steel with round top in white laminate with laquered MDF edge; in black painted steel with square top in black laminate with laquered MDF edge; in white painted steel with square top in white laminate with laquered MDF edge.





Varianti / Versions



A – 3012 / 3014

Tavolo H 760 con 2 basi Ø 600 - 700
in acciaio verniciato, piano
in laminato con bordo in MDF
laccato inclinato sp. 30. /
Table H 760 structure with 2 bases
Ø 600 - 700 in painted steel,
top laminate with laquered MDF
chamfered edge th 30.

Dimensioni / Dimensions

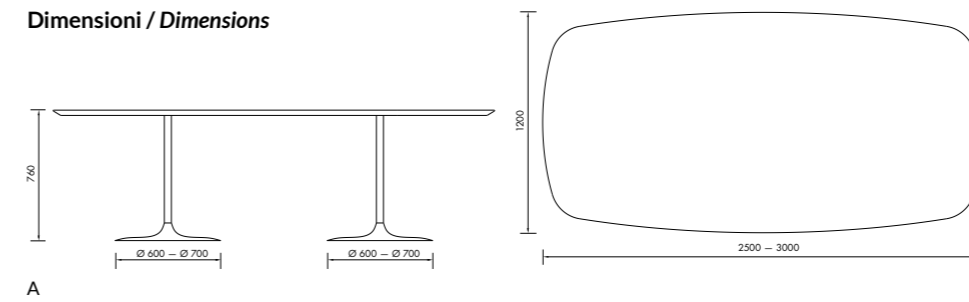

Varianti / Versions



B – 3010H5 / 3010H7

Tavolo H 500 - 740 con base Ø 470 in acciaio verniciato, piano in laminato con bordo in MDF laccato inclinato sp. 30. / Table H 500 - 740 structure with base Ø 470 in painted steel, top laminate with laquered MDF chamfered edge th 30.



C – 3011 / 3013

Tavolo H 760 con base Ø 600 - 700 in acciaio verniciato, piano in laminato con bordo in MDF laccato inclinato sp. 30. / Table H 760 structure with base Ø 600 - 700 in painted steel, top laminate with laquered MDF chamfered edge th 30.



D – 3010H1

Tavolo H 1100 con base Ø 470 in acciaio verniciato, piano in laminato con bordo in MDF laccato inclinato sp. 30. / Table H 1100 structure with base Ø 470 in painted steel, top laminate with laquered MDF chamfered edge th 30.

Dimensioni / Dimensions

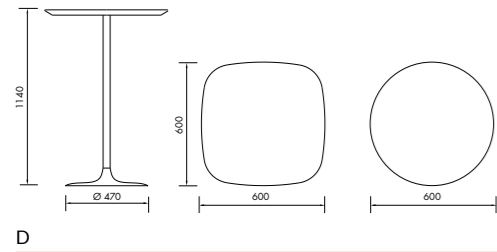
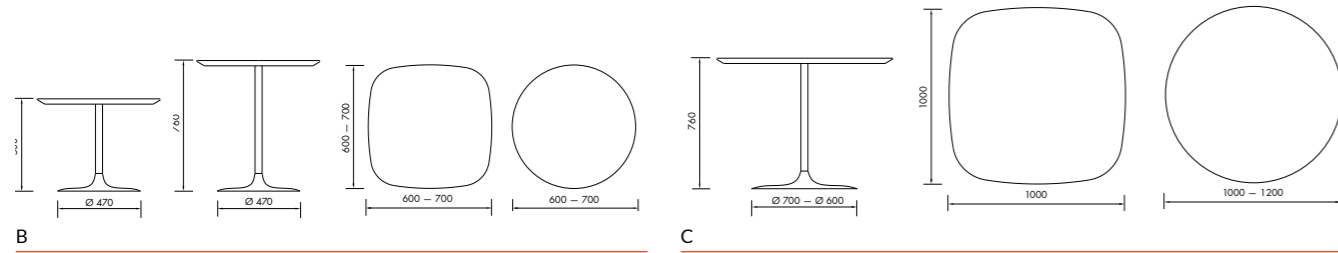

Colori piano / Top colors

Resina / Resine

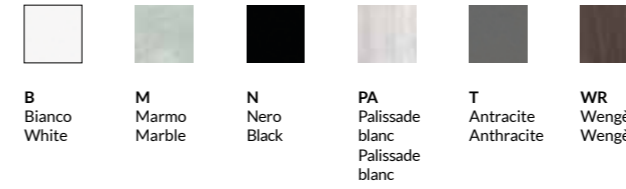

Hpl / Hpl



Laminato / Laminated

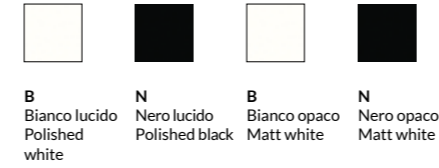

Solid core / Solid core



Struttura / Frames

Metalli / Metals



People

Indoor
Outdoor

People è un tavolo trasversale, caratterizzato dalla base in acciaio a quattro razze con piedini per la regolazione della planarità e dal piano personalizzabile nelle forme e nelle finiture. Il suo punto di forza è la semplicità, che lo rende adatto a diversi contesti, dagli spazi domestici a quelli collettivi. Il tavolo è disponibile in tre altezze, anche con piano ribaltabile.

People is a transversal table, characterized by a four-leg metal base with feet to regulate the planarity and by a customizable top in different shapes and finishes. Its clean design allows People to fit to different locations, such as private places as well as public ones. The table is available in three different heights, also with a folding top.

Designer
Nicola Cacco

Table

Tavoli People con due basi in acciaio verniciato bianco e piano rettangolare in nobilitato rovere; alto con base in acciaio verniciato bianco e piano tondo in nobilitato rovere.

People tables with two white painted steel bases and rectangular top in oak-coloured melamine; high version with white painted steel base and round top in oak-coloured melamine.

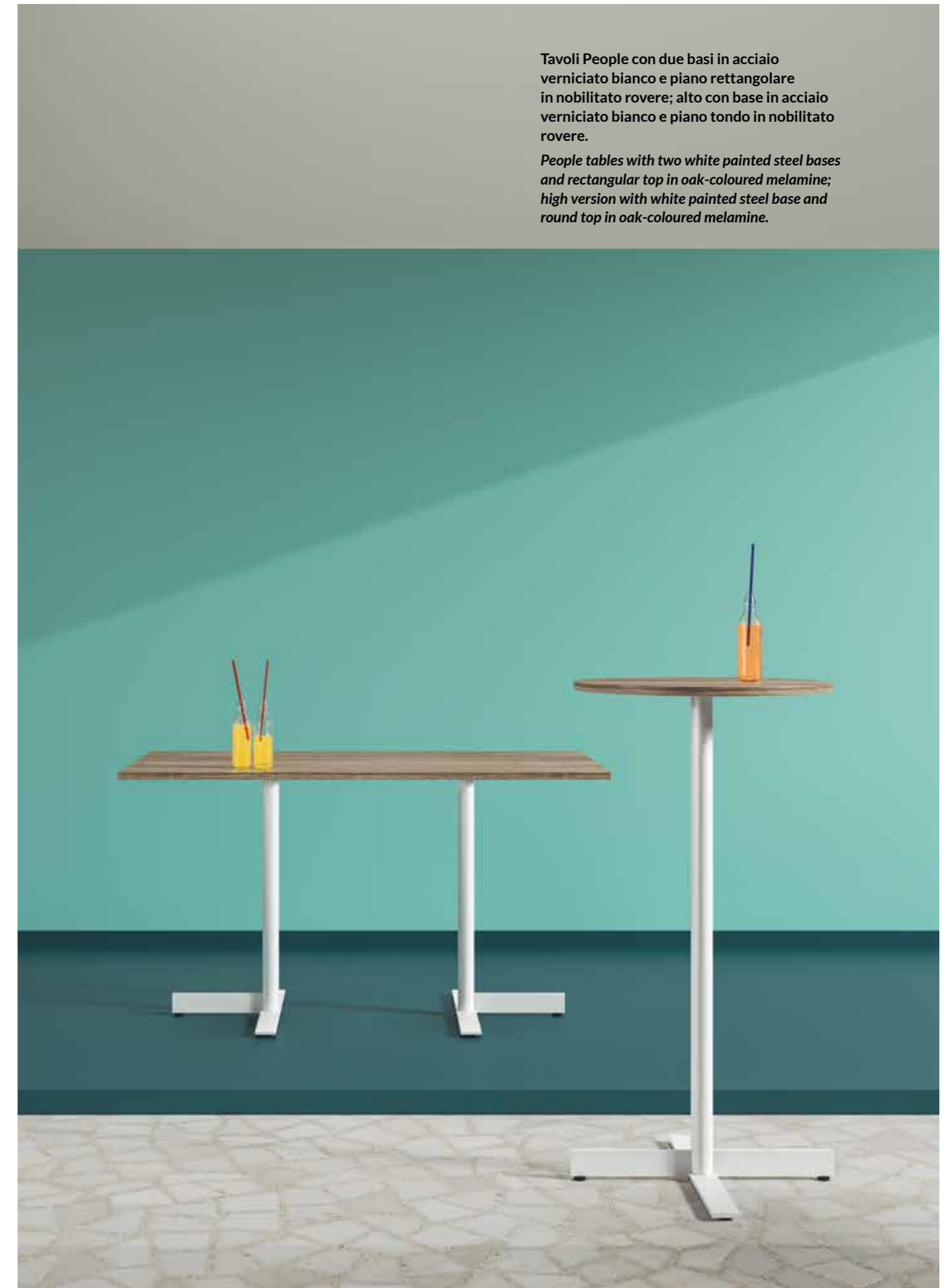

People sono visibili anche a pag. 201 e 206. / People visible also at p. 201 and 206.

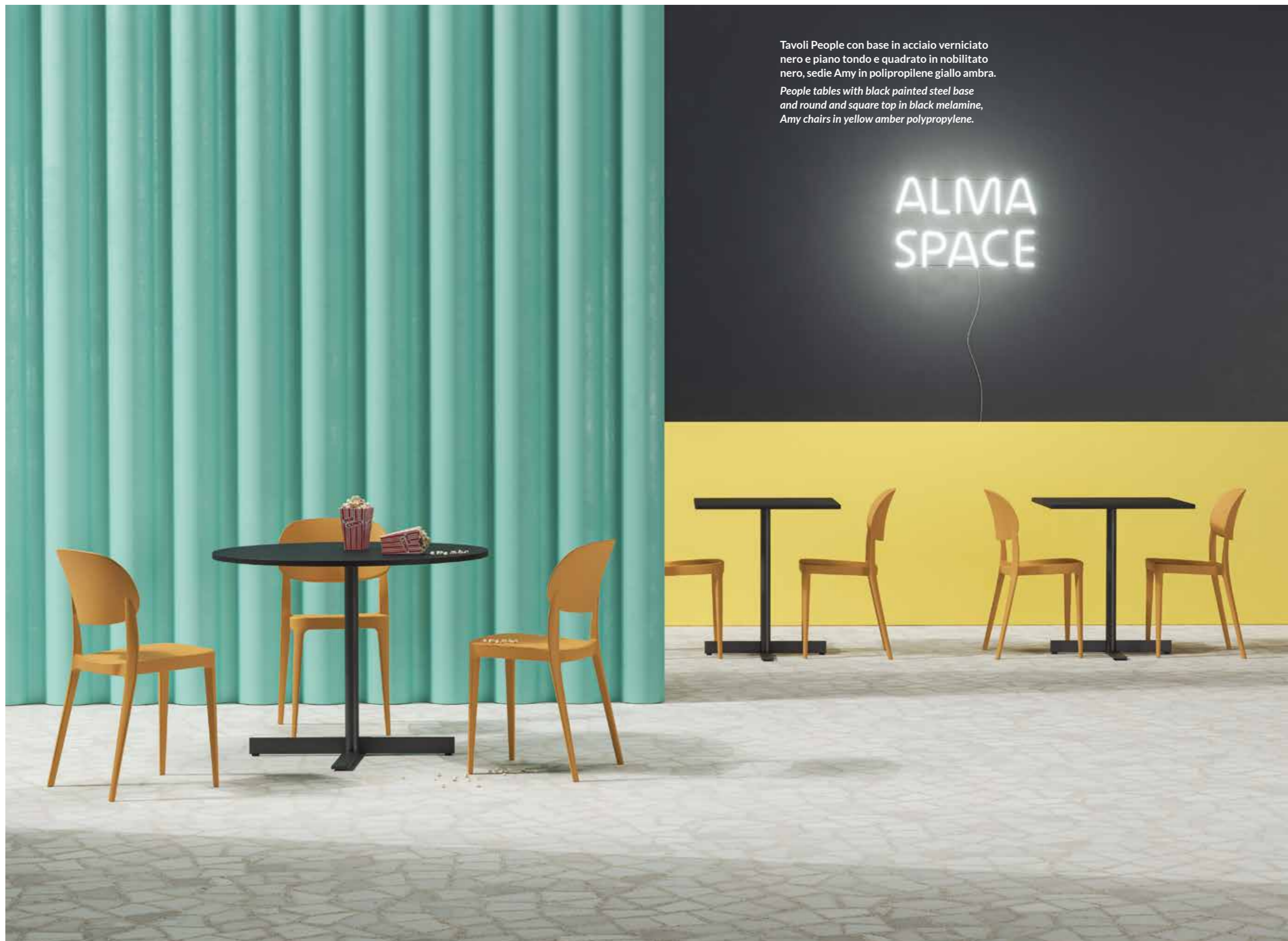

Tavoli People con base in acciaio verniciato nero e piano tondo e quadrato in nobilitato nero, sedie Amy in polipropilene giallo ambra.

People tables with black painted steel base and round and square top in black melamine, Amy chairs in yellow amber polypropylene.

ALMA
SPACE

Tavolo People verniciato nero con meccanismo di ribaltamento e piano in laminato nero.

People table with tip-up top mechanism and table top in black laminate.



Varianti / Versions



A - 3660

Tavolo H 765 con base Ø 600 in acciaio verniciato. / Table H 765 Ø 600 base in painted steel.



B - 3666

Tavolo H 765 con base da Ø 750 in acciaio verniciato. / Table H 750 Ø 750 base in painted steel.



C - 3665

Tavolo H 765 con 2 basi Ø 600 in acciaio verniciato. / Table H 765 n.2 Ø 600 bases in painted steel.



D - 3662

Tavolo H 1085 con base Ø 600 in acciaio verniciato. / Table H 1085 Ø 600 base in painted steel.

Dimensioni / Dimensions

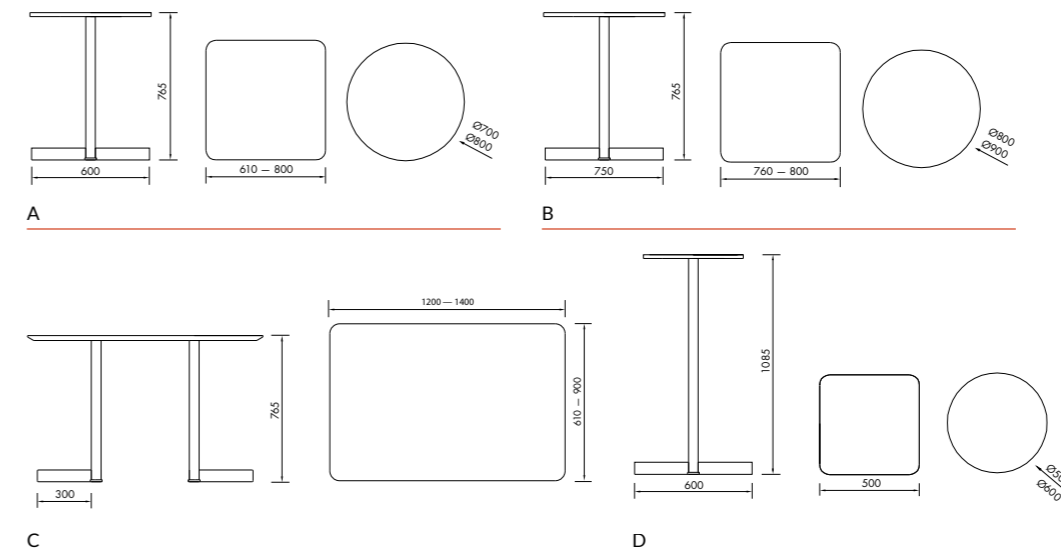

Colori piano / Top colors

Laminato nobilitato / Laminated melamine



Resina / Resine



Solid core / Solid core

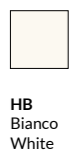

Mdf laccato / Mdf laquered



Hpl / Hpl



Struttura / Frame

Metalli / Metals

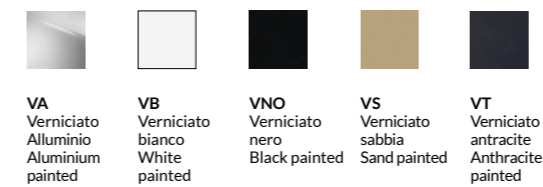

Ciak

Indoor
Outdoor

Ciak è un tavolino con base in alluminio a tre razze e piano rotondo o quadrato ribaltabile, anche in versione fissa. Proposto in una serie di colori brillanti e vivaci, leggero e funzionale, si usa sia indoor sia outdoor. Veloce da aprire e chiudere, agile da spostare e facile da stoccare, Ciak si fa apprezzare soprattutto nei contesti contract, ma è funzionale anche negli ambienti domestici e di lavoro.

Ciak is a table with a three-leg aluminium base and a folding circular or rectangular top, available also in the fixed version. Proposed in a series of bright and joyful colors, light weight and functional, it can be used both for indoor and outdoor. Easy to open and close, quick to move and stock, Ciak is appreciated especially for contract places but it is functional for domestic and work places, too.

Designer
MrSmith Studio

Table



Tavoli Ciak con struttura in alluminio verniciato antracite e piano tondo in HPL nero; verniciato sabbia e piano tondo in nobilitato rovere; verniciato bianco e piano quadrato in HPL bianco.

Ciak tables with anthracite painted aluminum structure and round black HPL top; sand painted and round top in oak melamine; white painted and square white HPL top.

Tavoli Ciak con struttura in alluminio verniciato verde bosco e piano tondo reclinabile in lamiera verniciata verde bosco; con struttura in alluminio verniciato senape e piano tondo in lamiera verniciata senape; con struttura in alluminio verniciato senape e piano quadrato in lamiera verniciata senape.

Sedie Amy in polipropilene bianco.

Ciak tables with dark green painted aluminum structure and reclining round top in dark green painted sheet metal; with mustard painted aluminum structure and round top in mustard painted sheet metal; with mustard painted aluminum structure and square top in mustard painted sheet metal. Amy chairs in white polypropylene.



Tavoli Ciak con struttura in alluminio verniciato senape e nero con piano rotondo reclinabile in lamiera verniciata nello stesso colore.

Ciak tables with mustard and black painted aluminum structure and reclining round top painted sheet metal in the same color.



Varianti / Versions



A – 3080

Tavolo in alluminio con piano ribaltabile tondo o quadrato in acciaio verniciato o altri materiali. / *Aluminum table with round or square folding top in painted steel or other materials.*



B – 3081

Tavolo in alluminio con piano fisso tondo o quadrato in acciaio verniciato o altri materiali. / *Aluminum table with fixed round or square top in painted steel or other materials.*

Dimensioni / Dimensions

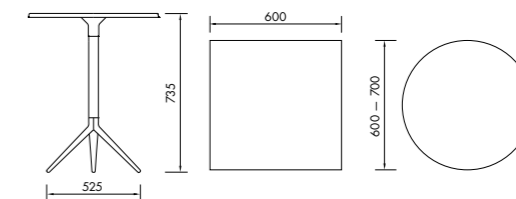

A – B

Colori piano / Top colors

Laminato nobilitato / *Laminated melamine*



B Bianco / White
C Grigio chiaro / Light grey
N Nero / Black
T Antracite / Anthracite

Alluminio / Aluminium



VB Verniciato bianco / White painted
VEB* Verniciato verde bosco / Dark green painted
VR* Verniciato rosso / Red painted
VS Verniciato sabbia / Sand painted
VSE* Verniciato senape / Mustard painted
VT Verniciato antracite / Anthracite painted

Hpl / Hpl



HB Bianco / White
HL Alluminio / Aluminium
HN Nero / Black
HS Sabbia / Sand

Struttura / Frame

Metalli / *Metals*



VB Verniciato bianco / White painted
VEB* Verniciato verde bosco / Dark green painted
VR* Verniciato rosso / Red painted
VS Verniciato sabbia / Sand painted
VSE* Verniciato senape / Mustard painted
VT Verniciato antracite / Anthracite painted

*Su richiesta / *On request*

Mojito

Tavolino da cocktail indoor o outdoor, Mojito si caratterizza per le linee essenziali e la praticità. Il fusto centrale, con base circolare, è in alluminio verniciato, mentre il piano rotondo e quadrato è disponibile in HPL oppure in resina.

Little cocktail table for indoors and outdoors, Mojito is characterized by essential lines and functionality. The central stem, with a circular base, is in painted steel, while the circle and the square top is available in HPL or in resin.

Designer
Alma

Indoor
Outdoor

Coffee table, table

Tavoli Mojito alto con base in alluminio verniciato antracite e piano in resina antracite; medio con base in alluminio verniciato sabbia e piano in HPL sabbia; basso con base in alluminio verniciato bianco e piano in HPL bianco.

Mojito high tables with anthracite painted aluminum base and anthracite resin top; medium-height version with sand painted aluminum base and sand HPL top; low-height version with white painted aluminum base and white HPL top.



Tavolo Mojito h1100 con struttura in alluminio verniciato e piano in hpl tondo, sgabello Jo in polietilene bianco.

Mojito table h1100 with painted aluminium frame and round HPL top, Jo stool in white polyethylene



Coffee table, table

Varianti / Versions



A – 3941

Tavolo H 500 con base tonda Ø 550 in alluminio con piano in resina, HPL, laminato o nobilitato. / Table H 500 with round base Ø 550 in aluminum with top in resin, HPL, laminate or melamine.



B – 3940

Tavolo H 750 con base tonda Ø 550 in alluminio con piano in resina, HPL, laminato o nobilitato. / Table H 750 with round base Ø 550 in aluminum with top in resin, HPL, laminate or melamine.



C – 3942

Tavolo H 1120 con base tonda Ø 550 in alluminio con piano in resina, HPL, laminato o nobilitato. / Table H 1120 with round base Ø 550 in aluminum with top in resin, HPL, laminate or melamine.

Dimensioni / Dimensions

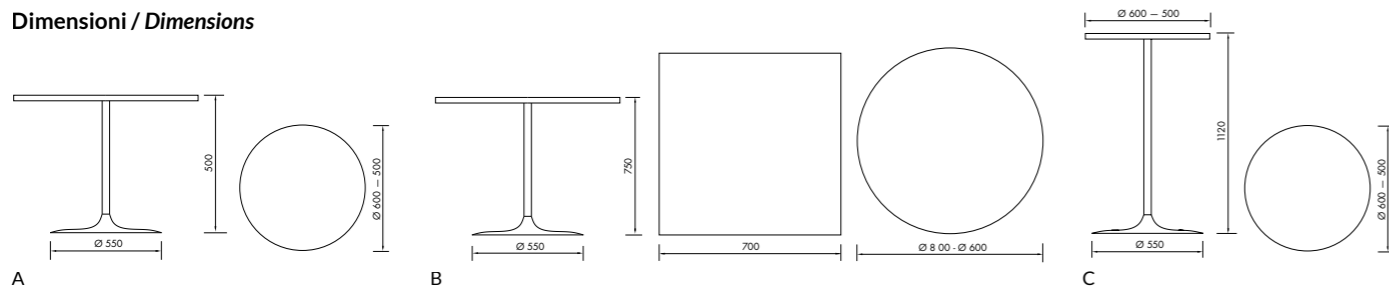

Colori piano / Top colors

Laminato nobilitato / Laminated melamine



B
Bianco
White

T
Antracite
Anthracite

Resina / Resine



B
Bianco
White

T
Antracite
Anthracite

WR
Wengè
Wengè

Solid core / Solid core



HB
Bianco
White

Mdf laccato / Mdf laquered



LE05B
Laccato bianco
White laquered

LE18
Laccato sabbia
Sand laquered

LE19
Laccato antracite
Anthracite laquered

Hpl / Hpl



HB
Bianco
White

HL
Alluminio
Aluminium

HN
Nero
Black

HS
Sabbia
Sand

Struttura / Frame

Alluminio / Aluminium



VB
Verniciato bianco
White painted

VS
Verniciato sabbia
Sand painted

VT
Verniciato antracite
Anthracite painted

Ice Table

Un tavolo robusto che rende protagonista il basamento, un cilindro imponente che si assottiglia avvicinandosi al piano. Realizzato in polipropilene e polietilene, anche con piano in HPL, Ice Table è adatto anche all'uso outdoor.

A thick table that makes its base the protagonist, a majestic cylinder which gets thinner to the top. Made of polypropylene and polyethylene, also with the top in HPL, Ice Table is suitable for outdoors, too.

Designer
Alma

Indoor
Outdoor

Table

Tavoli Ice Table con basamento in polietilene sabbia e piano tondo in HPL sabbia, con basamento in polietilene bianco e piano quadrato in polipropilene bianco.

Ice Table with base in sand polyethylene and round top in sand HPL, with base in white polyethylene and square top in white polypropylene.



Ice Table

Tavolo Ice in polietilene nero con piano quadrato in polipropilene nero, piano tondo in HPL nero.

Ice table in black polyethylene with square polypropylene black top, round HPL black top.



Table

Varianti / Versions



A – 3690

Tavolo H 730 in polietilene con piano sp. 30 in polipropilene colorato. / *Table H 730 with polyethylene base and colored polypropylene top th 30.*



B – 3691

Tavolo H 730 in polietilene con piano sp. 10 tondo o quadrato in HPL, disponibile in due dimensioni. / *Table H 730 in polyethylene with top th. 10 round or square in HPL, available in two sizes.*

Dimensioni / Dimensions

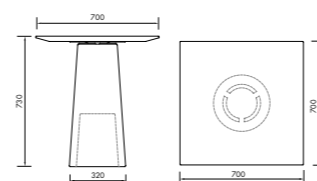

A

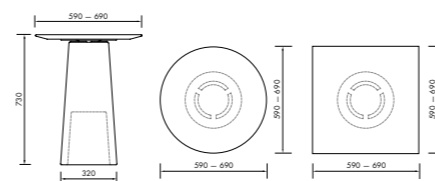

B

Piano e base / Top and base

Polietilene / Polyethylene



B
Bianco
White

BV
Blu viola
Violet blue

N
Nero
Black

S
Sabbia
Sand

Piano / Top

Hpl / Hpl



HB
Bianco
White

HN
Nero
Black

HS
Sabbia
Sand

Set-up

Stefano Soave disegna un tavolo insolito, impilabile grazie alla fessura ricavata sul piano in polietilene. Dettaglio estetico ma soprattutto funzionale, crea l'incastro perfetto per impilare i top una volta sfilati dalla base. Stabile e resistente, per la sua particolarità e ironia Set-up è pensato per locali giovani e di tendenza, dove si usa soprattutto all'esterno.

Stefano Soave designs an unusual table, stackable thanks to the hole on the top in polyethylene. This aesthetical but also functional detail allows the perfect interlocking to stack tops once removed from the base. Steady and resistant, Set-up has been created for young and fashion places, especially for outdoors, thanks to its particularity and easiness.

Designer
Stefano Soave

Table

Tavolo Set-up altezza sgabello con base in cemento e piano in polietilene verde bosco, altezza sedia con base in cemento e piano in polietilene rosso ciliegia.

Stool height Set-up table with concrete base and dark green polyethylene top, chair height version with concrete base and cherry red polyethylene top.



Indoor
Outdoor

Set-up

Piano tavolo Set-up con particolare della vaschetta in polistirolo per uso alimentare.

Set-up table top with polystyrene tray detail, suitable also for food use.



Table

Varianti / Versions



A – 3090

Tavolo H 730 in polietilene colorato con base in cemento. / *Table H 730 in colored polyethylene with concrete base.*



A – 3090

Tavolo H 1040 in polietilene colorato con base in cemento. / *Table H 1040 in colored polyethylene with concrete base.*

Dimensioni / Dimensions

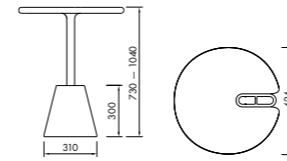

A

Piano / Top

Polietilene / Polyethylene

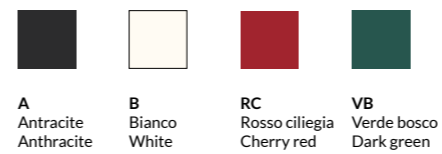

Dettaglio top impilato / Stackable top detail



Priscilla

Tavolo da indoor semplice e moderno, Priscilla si caratterizza per le linee essenziali e la praticità. Il fusto centrale, disponibile con base circolare oppure quadrata è in inox lucido o satinato. Il piano è disponibile in varie forme e materiali.

Simple and modern indoor table, Priscilla is characterized by essential lines and practicality. The central base, available with a circular or rectangular shape, in polished or satin stainless steel. Available many shapes or material tops.

Desingner
Alma

Table

Tavoli Priscilla con base tonda in inox lucido e piano in HPL tondo, con base quadrata in inox satinato e piano in HPL quadrato.

Priscilla tables with round polish inox base and round HPL top, with square inox satinized base and square HPL top.

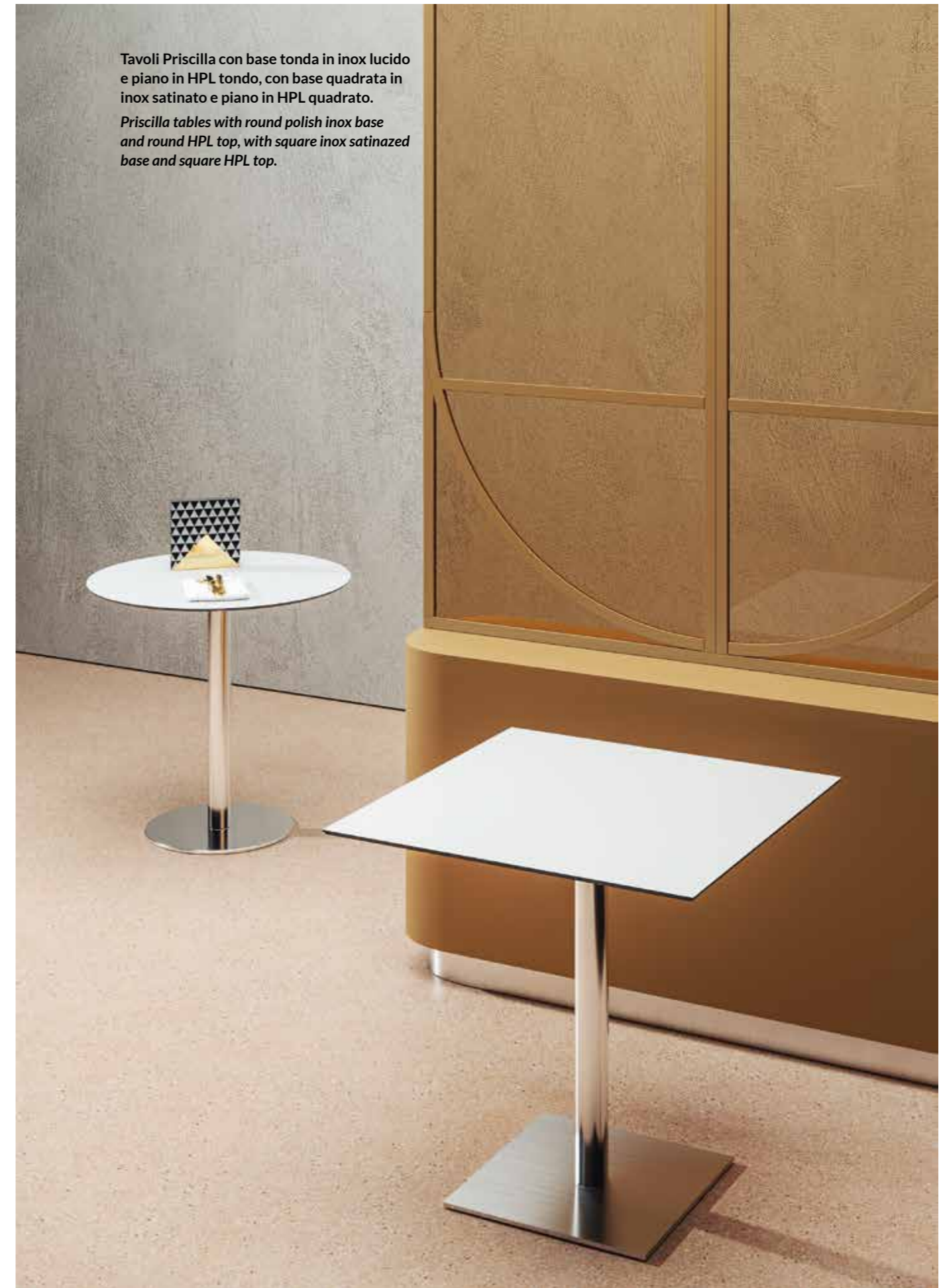

Priscilla

Varianti / Versions



A – 3050

Tavolo base tonda inox lucido/
satinato. / Table with round
polished/satinized inox base.



A – 3056

Tavolo base quadrata inox lucido/
satinato. / Table with square
polished/satinized inox base.

Dimensioni / Dimensions

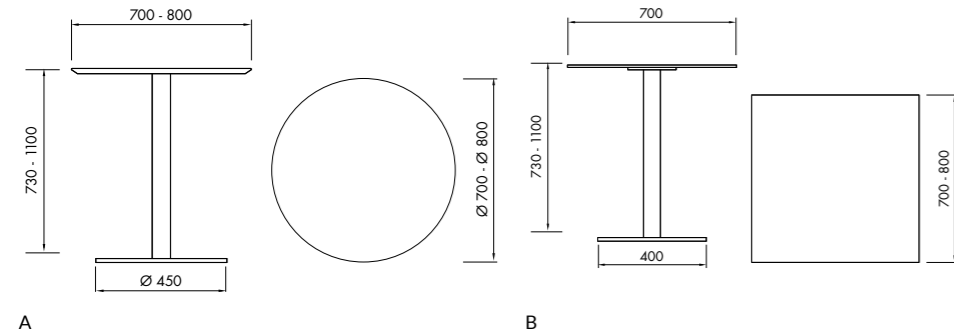

Colori piano / Top colors

Laminato nobilitato / Laminated melamine



B Bianco
White

C Grigio chiaro
Light grey

N Nero
Black

T Antracite
Anthracite

Resina / Resine



B Bianco
White

M Marmo
Marble

N Nero
Black

PA Palissade
blanc
Palissade
blanc

T Antracite
Anthracite

WR Wengè
Wengè

Solid core / Solid core



HB
Bianco
White

Hpl / Hpl



HB Bianco
White

HL Alluminio
Aluminium

HN Nero
Black

HS Sabbia
Sand

Struttura / Frame

Metalli / Metals



IL Inox lucido
Inox polished

IS Inox satinato
Inox
satinized

Finiture *Finishes*

Alma

Polipropilene e polietilene / Polypropylene and polyethylene



A Antracite / Anthracite
 B Bianco / White
 BS Blu smeraldo / Emerald blue
 BV Blu viola / Violet blue
 BX Viola bordeaux / Violet bordeaux
 C Cipria / Powder pink
 GA Giallo ambra / Amber yellow



N Nero / Black
 O Arancio / Orange
 RC Rosso ciliegia / Cherry red
 R2 Rosso mattone / Brick red
 S Sabbia / Sand
 VB Verde bosco / Dark green

Policarbonato / Polycarbonate

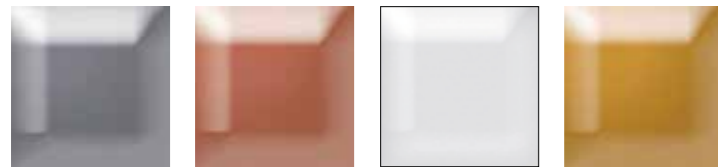

F Fumè
 RT Rosso / Red
 T Trasparente / Transparent
 YT Giallo / Yellow

Nylon



B Bianco lucido / White polished
 N Nero lucido / Black polished
 RP Rosso pompeiano lucido / Pompeian red polished

Finiture / Finishes

Finiture metalli e alluminio verniciato / Metal and painted aluminium finishes



CE Calamina / Calamine
 CR Cromato / Chromed
 IL Inox lucido / Inox polished
 IS Inox satinato / Inox satinized
 VA Verniciato alluminio goffratino / Aluminium painted
 VAG Verniciato bronzo / Bronze painted
 VB Verniciato bianco / White painted



VB1 Verniciato bianco lucido / White polished painted
 VEB Verniciato verde bosco / Dark green painted
 VN Verniciato nero lucido / Black polished painted
 VNO Verniciato nero goffratino / Black matt painted
 VR Verniciato rosso opaco / Red painted
 VS Verniciato sabbia opaco / Sand painted
 VSE Verniciato senape opaco / Mustard painted



VT Verniciato antracite / Anthracite painted

Alluminio / Aluminium



AU01 Nero / Black
 AU02 Grigio / Grey
 AU09 Lucido / Polished

Alma

Legni e MDF / Wood and MDF



HPL and Solid Core

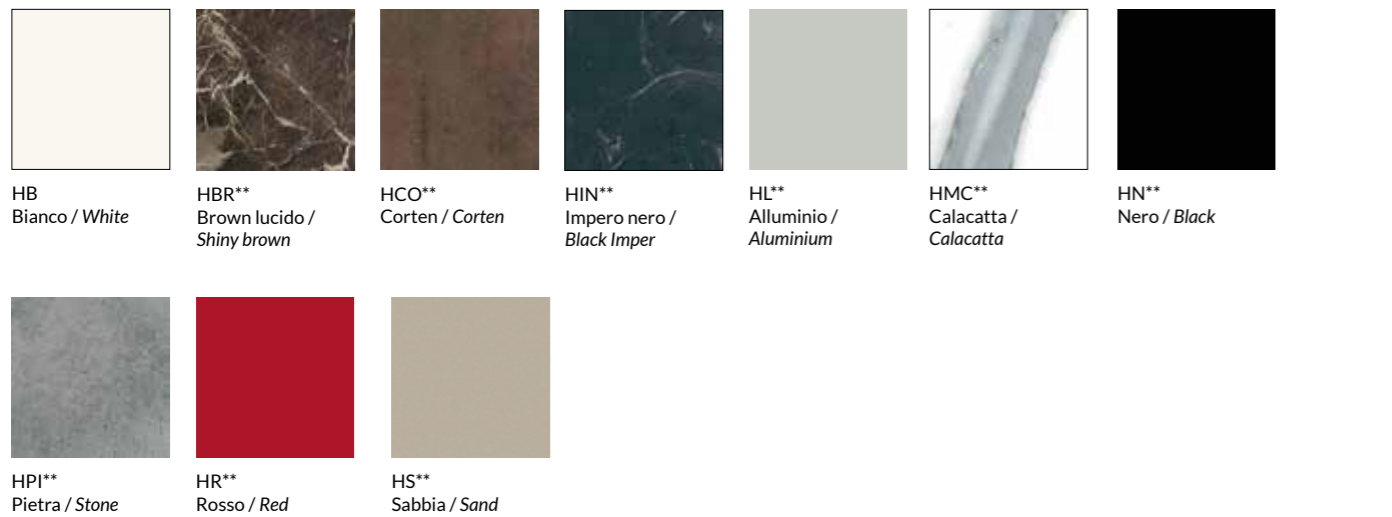

Finiture / Finishes

Marmo e pietra / Marble and stone



Laminato e nobilitato / Laminate and melamine

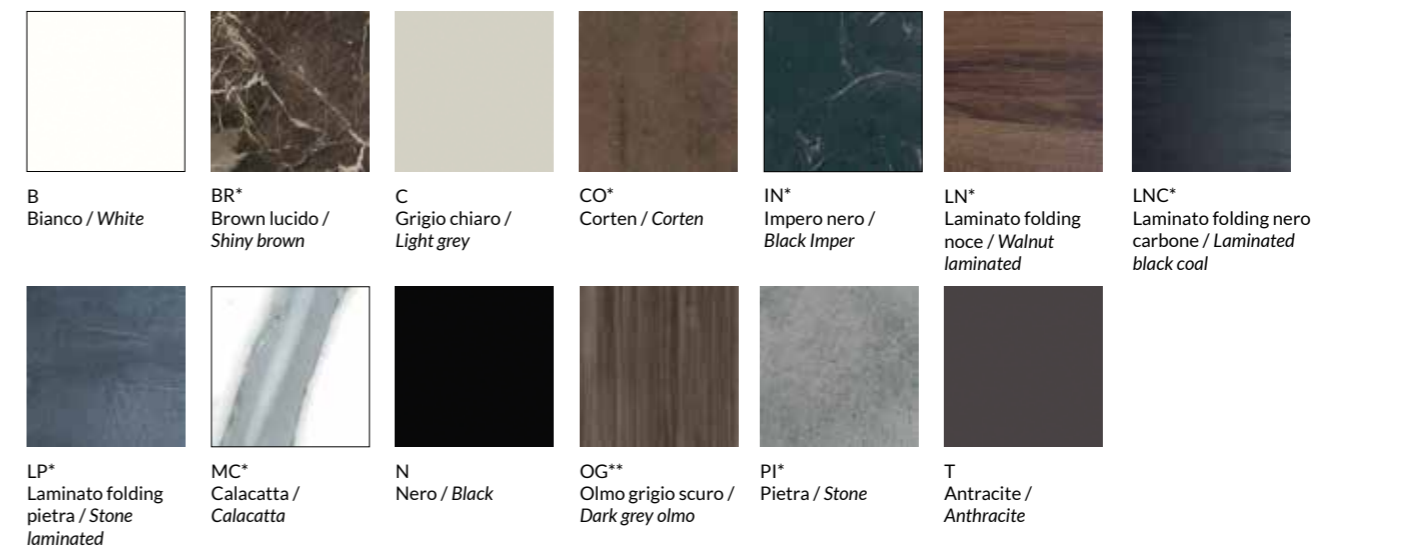

Resina / Resin

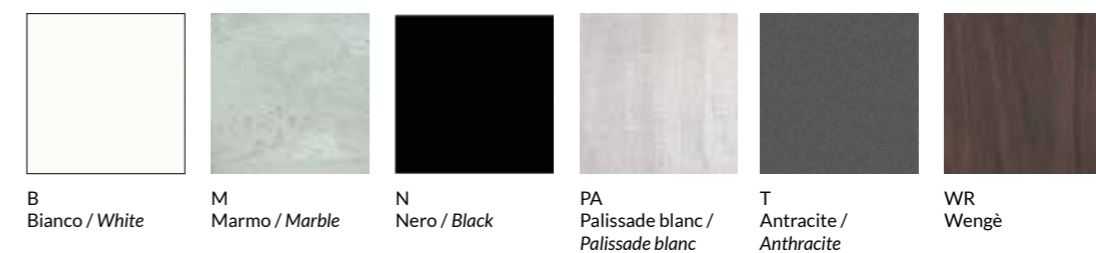

Rivestimenti *Materials*

Alma

Corde / Ropes



TR001
Sabbia / Sand



TR002
Antracite / Anthracite



TR003
Vinaccia / Burgundy

Tappeti / Rugs



RA01
Raja Melange nature / Raja nature Melange



RA02
Raja Melange blu / Raja blue Melange



LA01
Lana nature / Lana nature



LA02
Lana marrone / Lana brown



LA03
Lana grigio / Lana grey

Rivestimenti / Materials

Spalmato — categoria / category A

Antifiamma / Flame retardant



TE08



TE11



TE67



TE69



TE70



TE71



TE72



TE73



TE77



TE78



TE79



TE80

Touch — categoria / category A

Antifiamma / Flame retardant



ABFP0108



ABFP015796



ABFP016783

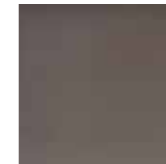

ABFP015800



ABFP015804



ABFP0120



ABFP0115



ABFP0114



ABFP0125



ABFP016747



ABFP016777



ABFP016791

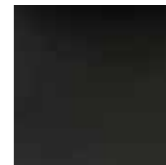

ABFP0116



ABFP0101

Roccia — categoria / category A

Antifiamma / Flame retardant



FDVRC1502



FDVRC1504



FDVRC2504



FDVRC6508



FDVRC4505



FDVRC4504



FDVRC4502



FDVRC3506



FDVRC3502



FDVRC5504



FDVRC4501



FDVRC6501



FDVRC7504



FDVRC7501



FDVRC6504



FDVRC8502



FDVRC8504

Alma

King L Kat — categoria / category A

 Antifiamma / Flame retardant



FDVKK1008 FDVKK1012 FDVKK2007 FDVKKLK3005 FDVKK3082 FDVKK4021 FDVKK4032



FDVKK5001 FDVKK6052 FDVKK6091 FDVKK7022 FDVKK8011 FDVKK8032

Stone Velvet — categoria / category B

 Antifiamma solo CAL 117 / Flame retardant only CAL 117



ERMSVA1501 ERMSVA1502 ERMSVA1505 ERMSVA1507 ERMSVA1508 ERMSVA1510 ERMSVA1511



ERMSVA1512 ERMSVA1513 ERMSVA1515 ERMSVA1516 ERMSVA1517 ERMSVA1518 ERMSVA1520



ERMSVA1521 ERMSVA1522 ERMSVA1524

Rivestimenti / Materials

Origami — categoria / category B

 Antifiamma solo CAL 117 / Flame retardant only CAL 117



ERMOR1601 ERMOR1603 ERMOR1604 ERMOR1605 ERMOR1609 ERMOR1611 ERMOR1612



ERMOR1613

Jojo — categoria / category B



ERMJJA1401 ERMJJA1405 ERMJJA1406 ERMJJA1408 ERMJJA1409 ERMJJA1411 ERMJJA1413



ERMJJA1414 ERMJJA1417 ERMJJA1420 ERMJJA1422 ERMJJA1423 ERMJJA1424 ERMJJA1426

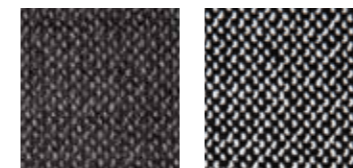

ERMJJA1428 ERMJJA1431

Alma

Capri — categoria / category C

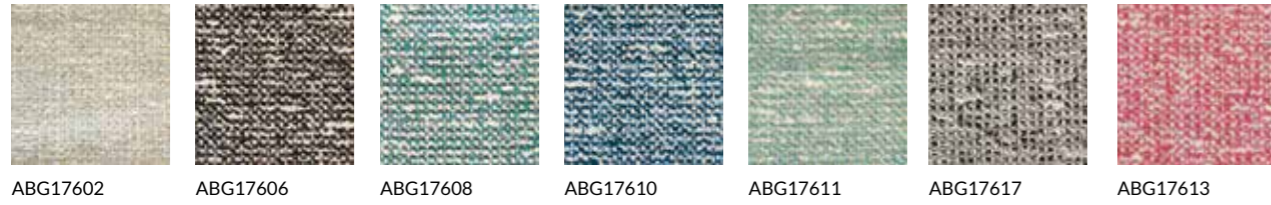

ABG17602 ABG17606 ABG17608 ABG17610 ABG17611 ABG17617 ABG17613

Fortezza — categoria / category C



PZAFO02 Bianco / White
PZAFO661 Beige / Beige
PZAFO241 Sabbia / Sand
PZAFO691 Vinaccia / Burgundy
PZAFO491 Antracite / Anthracite

☀️ 🔥 Antifiamma / Flame retardant

Itaca — categoria / category C

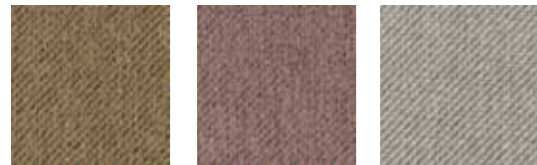

GLAIT33 Senape/Grigio Mustard/Grey
GLAIT35 Vinaccia/Antracite Burgundy/Anthracite
GLAIT25 Grigio/Grey

☀️ 🔥 Antifiamma / Flame retardant

Rivestimenti / Materials

Tropea — categoria / category D

☀️ 🔥 Antifiamma solo CAL 117 / Flame retardant only CAL 117

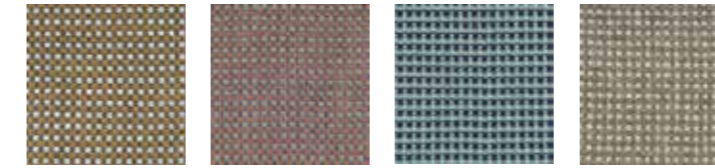

GLATR8 Senape/Antracite / Mustard/Anthracite
GLATR11 Vinaccia/Antracite / Burgundy/Anthracite
GLATR4 Azzurro/Blu / Light blue/Blue
GLATR13 Grigio / Grey

Plush — categoria / category D

🔥 Antifiamma solo CAL 117 / Flame retardant only CAL 117



ERMPLA1900 ERMPLA1901 ERMPLA1902 ERMPLA1904 ERMPLA1905 ERMPLA1906 ERMPLA1908

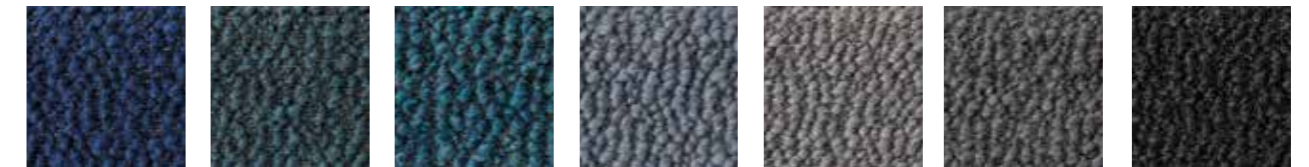

ERMPLA1909 ERMPLA1913 ERMPLA1914 ERMPLA1915 ERMPLA1916 ERMPLA1917 ERMPLA1918

Velluto Luna — categoria / category D

🔥 Antifiamma / Flame retardant



TE188 TE191 TE192 TE199 TE202 TE205 TE206



TE207 TE208 TE209 TE210 TE214 TE216 TE217



TE218 TE219 TE220 TE222 TE223 TE225 TE226

Alma

Salina — categoria / category E

☀️ 🔥 Antifiamma / Flame retardant



GLASA612 Senape / Mustard
GLASA613 Vinaccia / Burgundy
GLASA608 Blu / Blue
GLASA602 Grigio / Grey

Hero — categoria / category E

🔥 Antifiamma / Flame retardant



KVHR191 KVHR181 KVHR141 KVHR151 KVHR751 KVHR701 KVHR791



KVHR901 KVHR931 KVHR991 KVHR101 KVHR211 KVHR231 KVHR311



KVHR511 KVHR541 KVHR551 KVHR681 KVHR451 KVHR441 KVHR981

Rivestimenti / Materials

Pelle Miami — categoria / category PE

🔥 Antifiamma / Flame retardant



ICAMI1000 ICAMI1005 ICAMI1011 ICAMI1013 ICAMI2001 ICAMI2006 ICAMI2007



ICAMI2010 ICAMI4001 ICAMI4100 ICAMI4020 ICAMI4011 ICAMI5020 ICAMI5010



ICAMI8004 ICAMI9000

Pelle Lotus — categoria / category PE1

🔥 Antifiamma / Flame retardant



ICALOBLAC Nero / Black
ICALOSNOW Neve / Snow
ICALOCOGN Cognac / Cognac

Cuoio — categoria / category CU



CU02 Nero / Black
CU05 Testa di Moro / Brown
CU06 Bulgaro / Bulgaro
CU07 Vinaccia / Burgundy

Designers



Alma
 p. 170 Bistrò
 p. 210 Edward
 p. 246 Ice Table
 p. 220 Malèna
 p. 240 Mojito
 p. 254 Priscilla
 p. 54 Tappeti



Nicola Cacco
 p. 198 Anouk
 p. 88 Amarcord
 p. 228 People



**Daniele Lo Scalzo
 Moscheri**
 p. 64 Marnie



Mario Mazzer
 p. 112 Clint
 p. 96 Jo Cuoietto
 p. 186 Jo
 p. 80 Lips
 p. 174 Meg
 p. 108 Paloalto
 p. 180 Pepper
 p. 214 Virna
 p. 100 Woodbridge
 p. 118 X Collection



Sergio Mori
 p. 194 2525



MrSmith Studio
 p. 74 Agata
 p. 234 Ciak



Marco Piva
 p. 60 Magenta
 p. 18 Scala



Setacomincini
 p. 204 Estrosa



Stefano Soave
 p. 250 Set-up



JF Smith
 p. 162 Marlene



Valerio Sommella
 p. 144 Amy



**Tria.De design +
 Valèrie Galli**
 p. 152 Julie

I designer ci aiutano a dare forma alla nostra idea dell'abitare la casa, l'ufficio, gli spazi collettivi e quelli outdoor. Dalla loro interpretazione della personalità femminile, estroversa e sognatrice di Alma, che si esprime pienamente nei prodotti firmati dall'ufficio interno, nasce un catalogo ricco e vario, fatto di prodotti classici o all'avanguardia, sempre ispirati da un'instancabile curiosità.

The designers help us to shape our idea of living in the home, office, public spaces and outdoor ones. This rich and varied catalogue is born from their interpretation of Alma's feminine, extrovert and dreamer personality. A personality fully expressed in the products signed by the internal engineering dept, whose skills have brought Alma to present a collection made up of classic or avant-garde products, always inspired by tireless curiosity.

Alma

Sedie e poltroncine / Chairs and little armchairs



Agata
p. 74



Amy
p. 144



Estrosa
p. 204



Jo Cuoietto
p. 96



Jo
p. 186



Jo Soft
p. 186



Julie
p. 152



Lips
p. 80



Marlene
p. 162



Marnie
p. 64



Pepper Soft
p. 182



Scala
p. 26



Scala
p. 38



Y Armchair
p. 124



X Chair
p. 128

Collection

Sgabelli / Stools



2525
p. 194



Anouk
p. 198



Estrosa
p. 204



Jo
p. 188



Scala
p. 42



X Stool
p. 132

Alma

Poltrone e divani / Armchairs and sofa



Amarcord
p. 88



Meg
p. 174



Scala
p. 30



Scala
p. 34



Scala
p. 18



Scala
p. 20



X Big
p. 119



X Big Too
p. 122



X Pouf
p. 119



X Big Foot
p. 140

Collection

Tavolini / Coffee tables



Armarcord
p. 88



Magenta
p. 60



Malèna
p. 220



Mojito
p. 241



Pepper
p. 180



Scala
p. 32



Scala
p. 22



X Table
p. 121

Panche / Benches



Estrosa
p. 209



X Beam
p. 135

Tavoli / Tables



Bistrò
p. 170



Ciak
p. 234



Clint
p. 112



Edward
p. 210



Ice Table
p. 246



Malèna
p. 220



Marnie
p. 66



Mojito
p. 240



Paloalto
p. 108



People
p. 228



Priscilla
p. 254



Scala
p. 43



Set-up
p. 250



Virna
p. 214



Woodbridge
p. 100



X Table
p. 121

Collection

Tappeti / Rugs



Raja
p. 54

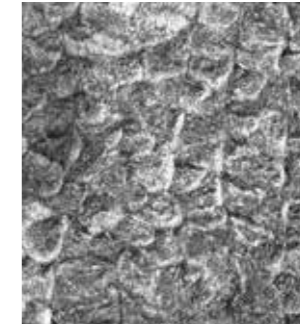

Lana
p. 54

REPRESENTED BY:



Interra Contract
1550 South Coast Hwy, # 205
Laguna Beach, CA 92651
(949) 497-0277
www.InterraContract.com