

SPSK60IPS

Cooker size	60x60 cm
N. of cavities with energy label	1
Heat source first cavity	Electric
Hob type	Induction
Type of main oven	Thermo-ventilated
Cleaning system main oven	Pyrolytic
EAN code	8017709304980
Energy efficiency class	A



Aesthetics

Aesthetics	Classic	Display	Touch
Series	Concert	No. of controls	6
Colour	Toniton Green	Serigraphy colour	Black
Design	Standard	Handle	Smeg Classic
Door	With 2 horizontal strips	Handle Colour	Brushed stainless steel
Upstand	Yes	Glass type	Stopsol
Hob colour	Stainless steel	Feet	Silver
Command panel finish	Stainless steel	Storage compartment	Door
Control knobs	Smeg Classic	Logo	Assembled st/steel
Controls colour	Stainless steel	Logo position	Facia below the oven

Programme / Functions

No. of cooking functions 9

Traditional cooking functions



Static



Fan assisted



Circulaire



Turbo (circulaire + bottom + upper +



ECO



Small grill

fan)



Large grill



Fan grill (large)



Fan assisted base

Cleaning functions



Hob technical features



Total no. of cook zones 4

Front left - Induction - single - 1.60 kW - Booster 1.85 kW - 21.1x19.1 cm

Rear left - Induction - single - 2.10 kW - Booster 2.30 kW - 21.1x19.1 cm

Rear right - Induction - single - 2.10 kW - Booster 2.30 kW - Ø 21.0 cm

Front right - Induction - giant - 1.20 kW - Booster 1.40 kW - Ø 18.0 cm

No. of cooking zones with Booster	4	Minimum pan diameter indication	Yes
Automatic switch off when overheat	Yes	Selected zone indicator	Yes
Automatic pan detection	Yes	Residual heat indicator	Yes

Main Oven Technical Features



No. of lights	1	Total no. of door glasses	4
Fan number	1	No. of thermo-reflective door glasses	3
Net volume of the cavity	70 litres	Safety Thermostat	Yes
Gross volume, 1st cavity	79 l	Heating suspended when door is opened	Yes
Cavity material	Easy clean enamel	Cooling system	Tangential
Shelf positions	5	Door Lock During Pyrolysis	Yes
Type of shelves	Metal racks	Usable cavity space dimensions (HxWxD)	360x444x425 mm
Light type	Halogen	Temperature control	Electro-mechanical
Light power	40 W	Lower heating element power	1200 W
Cooking time setting	Start and Stop	Upper heating element - Power	1000 W
Light when oven door is open	Yes	Grill element	1700 W
Door opening	Flap down	Large grill - Power	2700 W
Removable door	Yes	Circular heating element - Power	2000 W
Full glass inner door	Yes	Grill type	Electric
Removable inner door	Yes		

Options Main Oven

Timer	Yes	Minimum Temperature	50 °C
End of cooking acoustic alarm	Yes	Maximum temperature	280 °C

Accessories included for Main Oven & Hob



Rack with back and side stop	2	Telescopic Guide rails, partial Extraction	1
20mm deep tray	2	Meat Probe	1
40mm deep tray	1	Child Lock	1

Electrical Connection

Nominal power	10400 W	Voltage 2 (V)	380-415 V
Current	46 A	Frequency	50/60 Hz
Voltage	220-240 V	Terminal block	5 poles

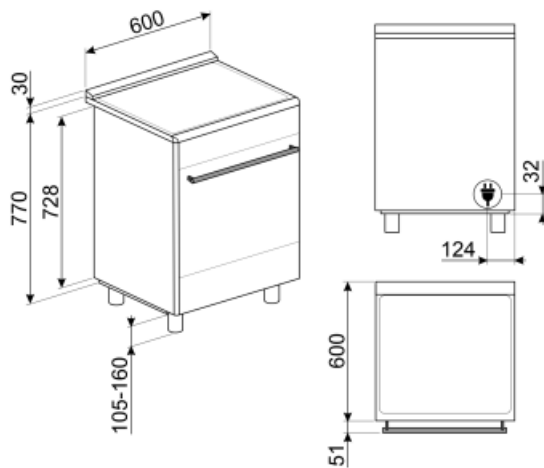

Not included accessories



SFLK1
Child lock

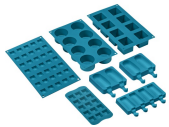

SMOLD
Set of 7 silicone moulds for ice creams, ice lollies, pralines, ice cubes or to portion food. Usable from -60°C to +230°C



GTT
Totally extractable telescopic guides (1 level) Extraction: 433 mm Material: Stainless steel AISI 430 polished



SCRP
Induction and ceramic hobs and teppanyaki scraper

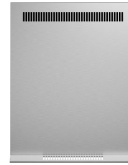



























KITP60X9
Splashback, 90 cm, stainless steel, suitable for pyrolytic Concert cookers



GTP
Partially extractable telescopic guides (1 level) Extraction: 300 mm Material: Stainless steel AISI 430 polished

Symbols glossary

 <p>A: Product drying performance, measured from A+++ to D / G depending on the product family</p>	 <p>Power booster: option allows the zone to work at full power when very intense cooking is necessary.</p>
 <p>Child lock: some models are fitted with a device to lock the programme/cycle so it cannot be accidentally changed.</p>	 <p>Air cooling system: to ensure a safe surface temperatures.</p>
 <p>Quadruple glazed: Number of glazed doors.</p>	 <p>ECO-logic: option allows you to restrict the power limit of the appliance real energy saving.</p>
 <p>Enamel interior: The enamel interior of all Smeg ovens have a special antacid lining which helps keep the interior clean by reducing the amount of cooking grease adhering to it.</p>	 <p>Circogas: In gas ovens the fan distributes the heat quickly and evenly throughout the oven cavity, avoiding flavour transfer when cooking a number of different dishes at the same time. In electric ovens this combination completes cooking more quickly of foods that are ready on the surface, but that require more cooking inside, without further browning.</p>
 <p>Fan with upper and lower elements: The elements combined with the fan aim to provide more uniform heat, a similar method to conventional cooking, so pre-heat is required. Most suitable for items requiring slow cooking methods.</p>	 <p>Upper and lower element only: a traditional cooking method best suited for single items located in the centre of the oven. the top pf the oven will always be hottest. Ideal for roast, fruit cakes, bread etc.</p>
 <p>Circulaire: The combination of the fan and circular element around it gives a hot air cooking method. This provides many benefits including no preheat if cook time is more than 20 minutes, no flavour transfer when cooking different foods at the same time, less energy, and shorter cook times. Good for all types of food.</p>	 <p>ECO: The combination of the grill, fan and lower element is particularly suitable for cooking small quantities of food.</p>
 <p>Grill element: Using of grill gives excellent results when cooking meat of medium and small portions, especially when combined with a rotisserie (where possible). Also ideal for cooking sausages and bacon.</p>	 <p>Half grill: For rapid cooking and browning of foods. Best results can be obtained by using the top shelf for small items, the lower shelves for larger ones, such as chops or sausages. For half grill heat is generated only at the centre of the element, so is ideal for smaller quantities.</p>
 <p>Fan with grill element: The fan reduces the fierce heat from the grill, providing an excellent method of grilling various foods, chops, steaks, sausages etc. giving even browning and heat distribution, without drying out the food. The top two levels recommended for use, and the lower part of the oven can be used to keep items warm at the same time, an excellent facility when cooking a grilled breakfast. Half grill (centre portion only) is ideal for small quantities of food.</p>	 <p>Circulaire with upper and lower elements: The use of the fan with both elements allows food to be cooked quickly and effectively, ideal for large joints that require thorough cooking. It offers a similar result to rotisserie, moving the heat around the food, instead of moving the food itself, enabling any size or shape to be cooked.</p>
 <p>Giant zone: The giant zone offers extra space and flexibility.</p>	 <p>Overheat protection: The safety system that automatically turns off the hob in case of overheating of the control unit.</p>

-
- | | |
|---|---|
|  Induction: The work of these hobs is based on the principle of electromagnetic induction. The heat is generated directly in the bottom of the pan during its contact with the hob. |  All glass inner door: All glass inner door, a single flat surface which is simple to keep clean. |
|  The inner door glass: can be removed with a few quick movements for cleaning. |  Side lights: Two opposing side lights increase visibility inside the oven. |
|  Pyrolytic: Pyrolytic cleaning cycles can be selected as necessary to automatically clean the oven interior. |  Indication of residual heat: After the glass ceramic hob is switched off the residual heat indicator shows which of the heating zones still remains hot. When the temperature drops below 60 ° C, the indicator goes out. |
|  The oven cavity has 5 different cooking levels. |  Telescopic rails: allow you to pull out the dish and check it without having to remove it from the oven entirely. |
|  The capacity indicates the amount of usable space in the oven cavity in litres. | |