

Kit 500 Series Installation Instructions for Wood Posts, Metal Posts, and Wood Posts with Composite Sleeves

Hole size for both 1/8" dia. cable and 3/16" dia. cable installation:

Drill 9/32" hole 1-1/2" into the inside of wood end posts for the LE-6. Drill through composite sleeve to get to the wood post.

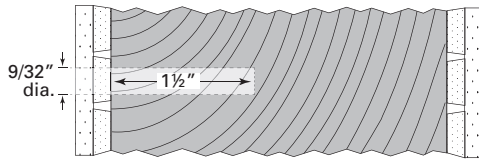

OR

Drill and tap 5/16-24 threaded hole into the inside of metal end posts for the TT-6B.

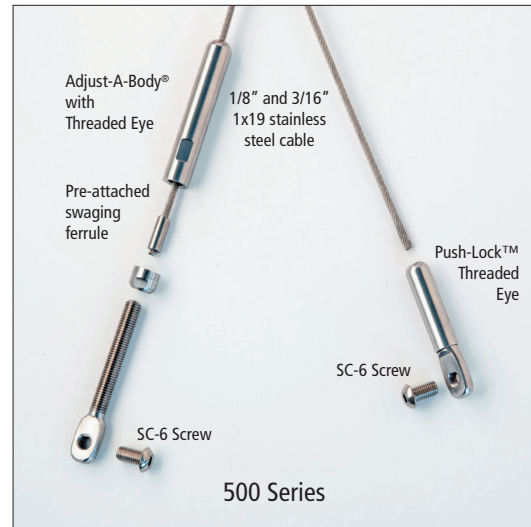
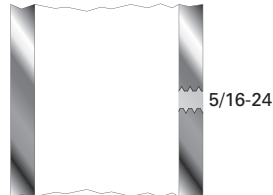

1. Install the attaching hardware: LE-6 for wood end post, LE-6L for composite sleeve, or TT-6B for metal end posts.

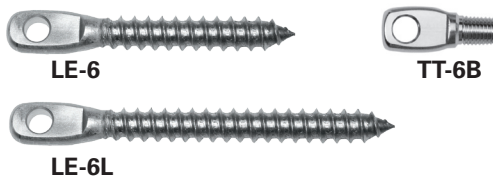

2. Install the tensioning end first with the Adjust-A-Body with Threaded Eye Tensioner (A-JTE6) by attaching the eye to eye with the supplied SC-6 screw.
3. Screw the lock nut all the way onto the 2" long threaded end of the bolt.
4. Thread the body with the cable attached onto the threaded end of the bolt and turn half way up the threads.

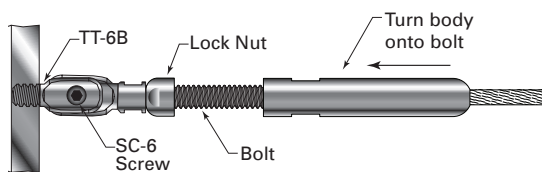

5. Run the bare end of the cable through all your intermediate posts and to the end post where you will be installing the Push-Lock fitting.

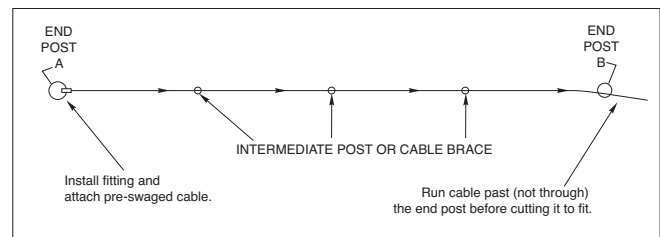

If you are bending cable across a landing with wood posts, you will want to insert a Post-Protector Tube (order CS-TUBE-6 separately from Accessories) into the wood post where the cable angles out of the post. Drill a 1/4" hole 1-1/2" deep straight into the post to receive the CS-Tube.

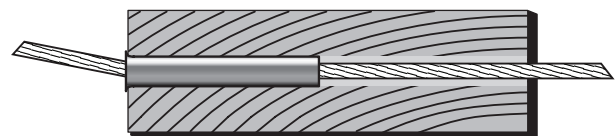

If you are bending cable around a corner with composite sleeves, you will want to attach a cable support (order 36" or 42" Cable Support separately from Braces) to the outside of the sleeved post where the cable angles out of the post. The support lags to the post with wood screws (not included).

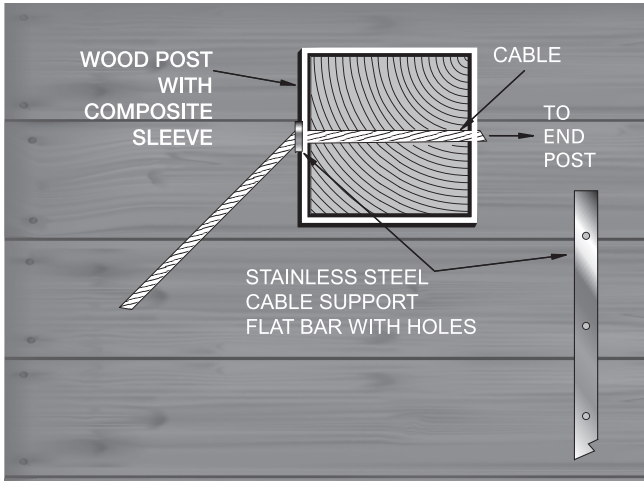

6. Connect the Push-Lock fitting to the threaded part on the post by attaching the eye to eye with the supplied SC-6 screw.

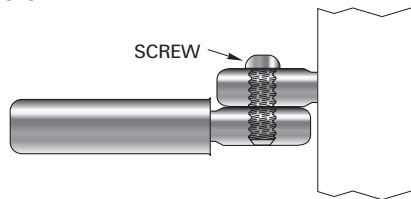

7. Pull the cable tightly along the side of the fitting and mark the cable 1-3/16" from the end of the fitting opposite the post. Mark and cut the cable on your mark.

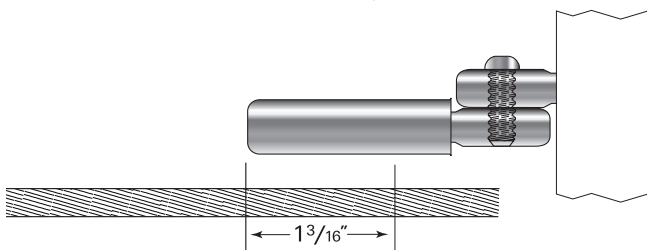

8. At Post A, detach the body from the threaded eye to allow cable slack so you can perform the next step.

9. At Post B, push the cable into the hole in the fitting as far as it will go (approximately 1-1/16"). Twist the cable in a right hand direction as you push it into the fitting.

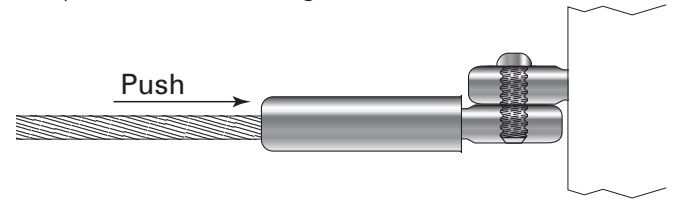

10. Go back to Post A and hand turn the body back onto the threaded eye. Tension the cable by holding it to prevent the cable from turning while you turn the Adjust-A-Body with a 7/16" open-end wrench. Be careful to protect the cable from damage while tensioning the Adjust-A-Body.

11. Turn the lock nut against the body and tighten with open-end wrenches. Leave about 1/2" of thread exposed when tight for future tensioning if needed.

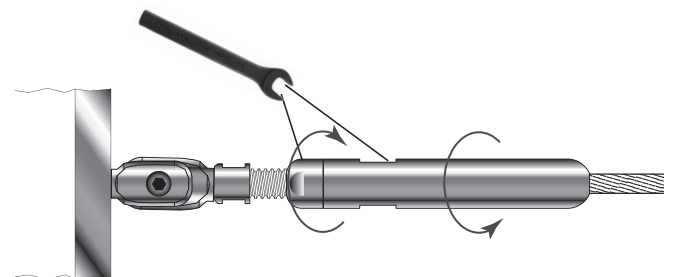

12. Tension in sequence, beginning with the outside cables and moving back and forth toward the center. Finished cables should be tensioned to have only 1/4" of play when finger-pulled.

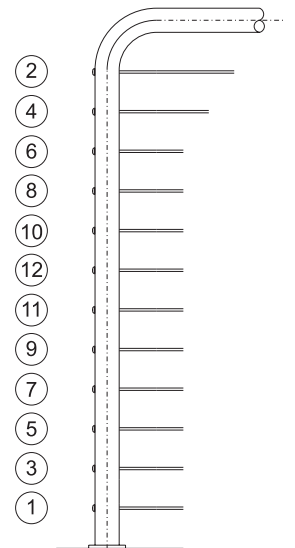

RECOMMENDED TENSIONING SEQUENCE