

# \*\*\* NOTICE BEFORE ASSEMBLY \*\*\*

Please choose the **CHAISE** will be on  
the LEFT or RIGHT hand side.

#Assembly Instruction I : CHAISE ON THE LEFT

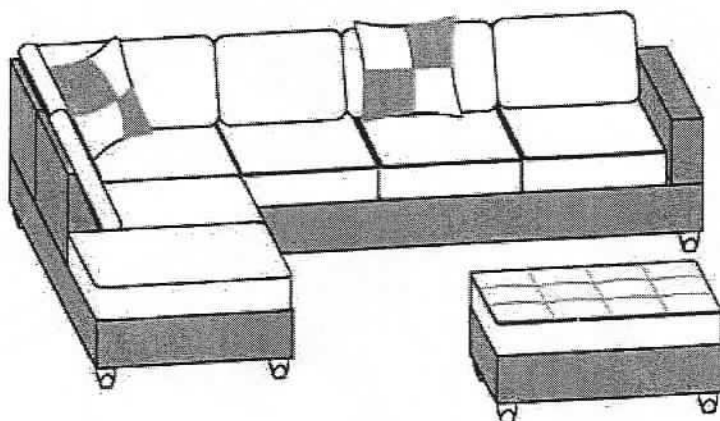

(See Rear Page)

#Assembly Instruction II : CHAISE ON THE RIGHT

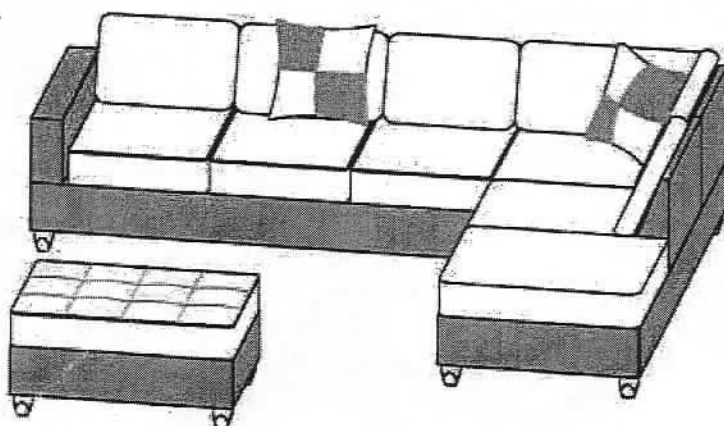

(See Rear Page)

## PARTS LIST

BOX-1

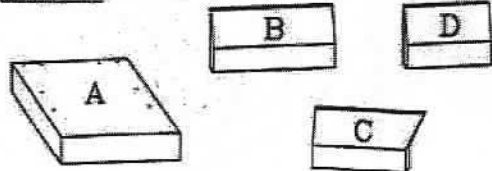

BOX-2

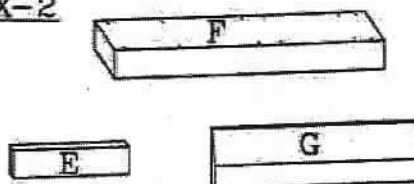

BOX-3

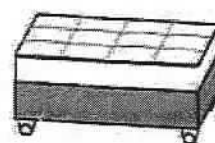

1. x12

2. x12

3. x12

4. x12

5. x1

x12

Insturction I :CHAISE ON THE LEFT

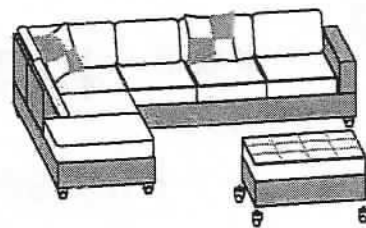
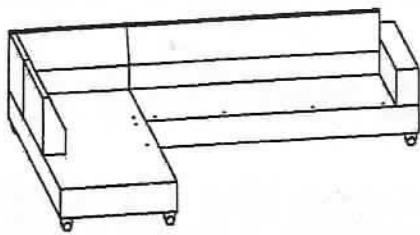
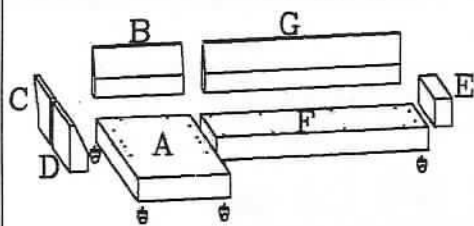

BOX-1

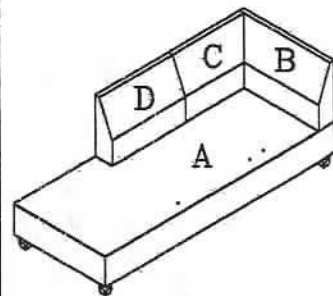
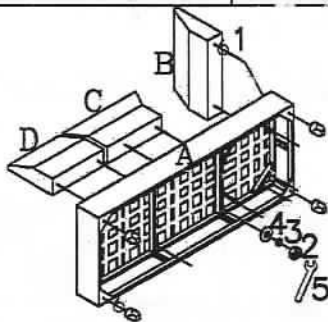
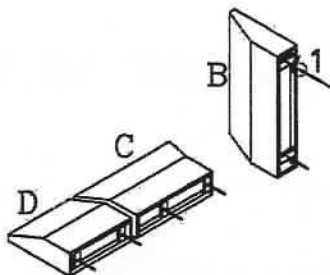
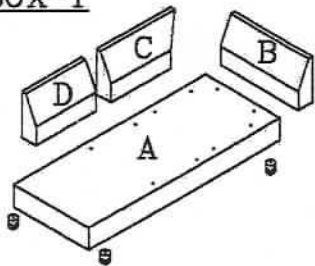

BOX-2

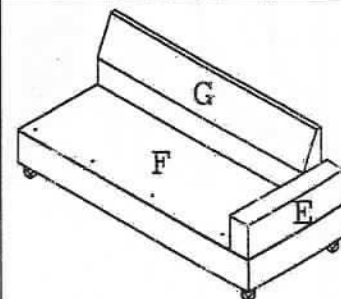
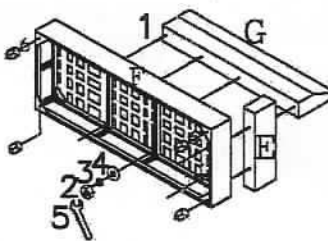
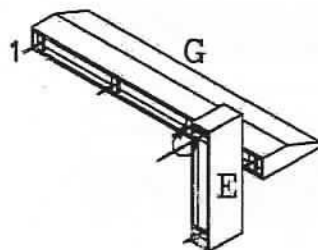
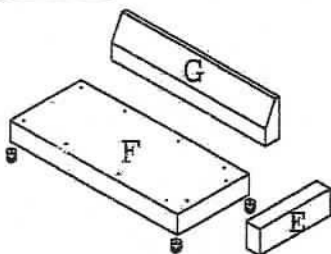

Insturction II :CHAISE ON THE RIGHT

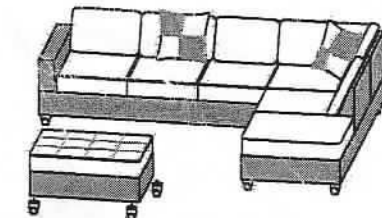
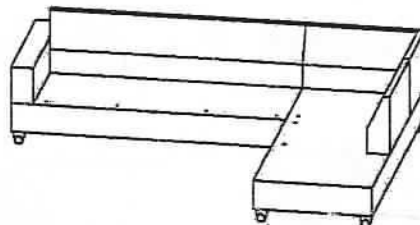
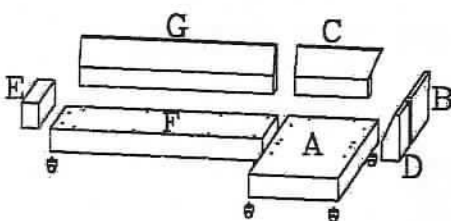

BOX-1

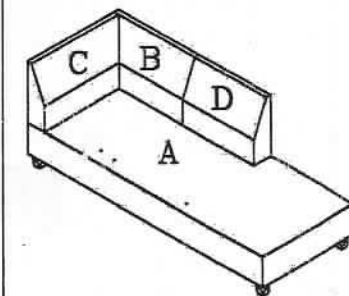
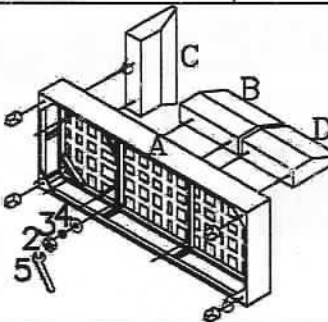
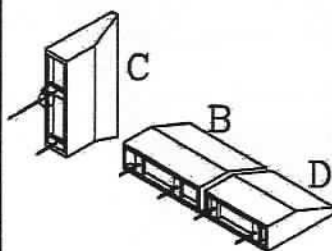
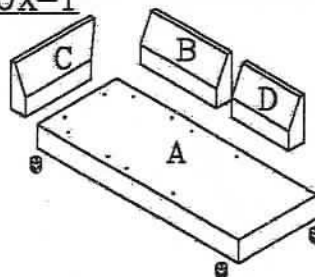

BOX-2

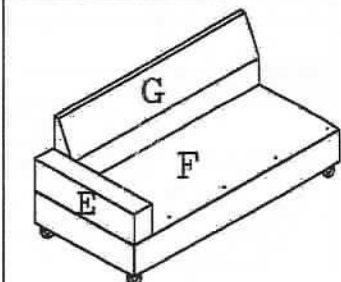
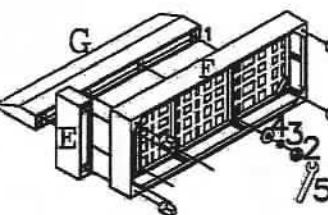
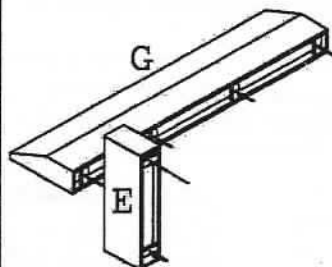
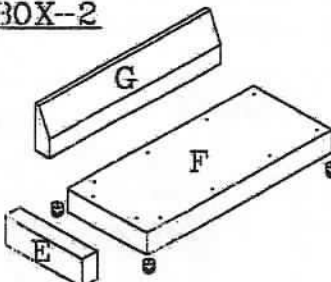

## OPTIONAL: CHAISE + SOFA(SECTIONAL)

**STEP1-INSERT THE "N" SHAPE HANGER INTO THE ONE-ARM CHASE FRAME AND ONE-ARM SOFA FRAME TO ATTACH TOG ETHER**

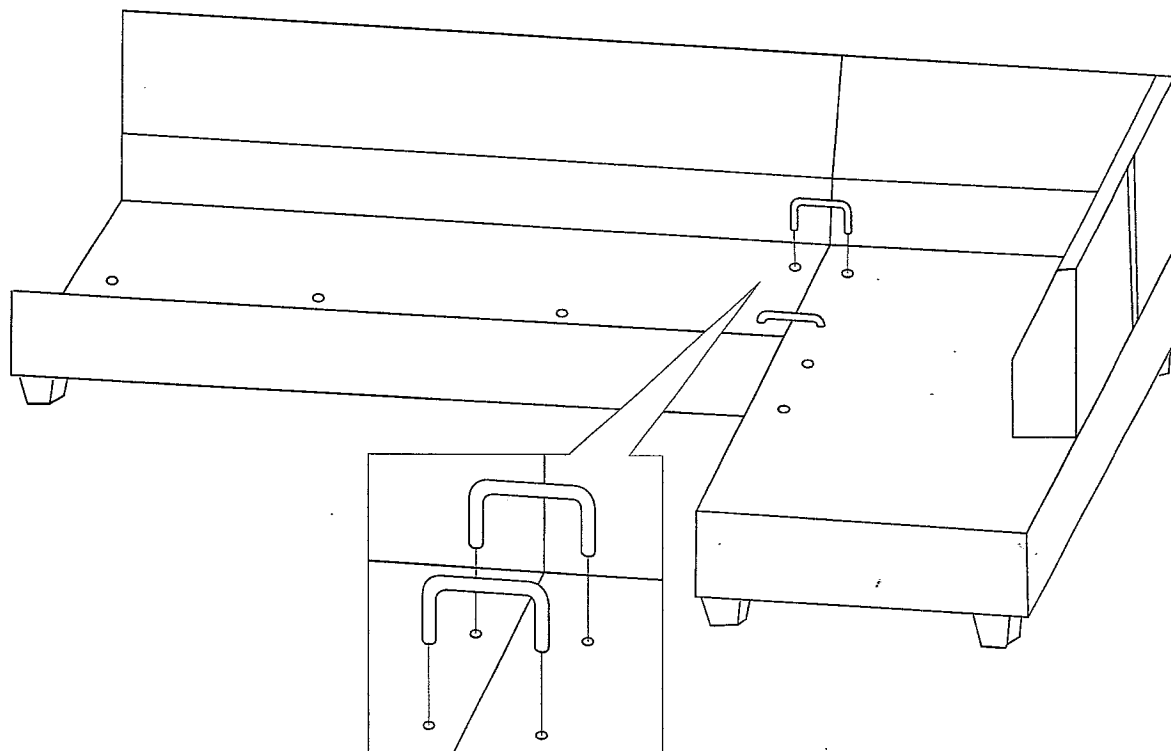

## CHAISE + SOFA(SECTIONAL)

**STEP1-INSERT THE "N" SHAPE HANGER INTO THE ONE-ARM CHASE FRAME AND ONE-ARM SOFA FRAME TO ATTACH TOG ETHER**

