

DuraLabel **TORO**®



PORTABLE STANDALONE PRINTER

USER GUIDE



800.788.5572

DuraLabel.com

Copyright Information

No part of this manual, including the products and software described in it, may be reproduced, transmitted, transcribed, stored in a retrieval system, or translated into any language in any form or by any means, except documentation kept by the purchaser for backup purposes, without the express written permission of Graphic Products, Inc.

Products and corporate names appearing in this manual may or may not be registered trademarks or copyrights of their respective companies, and are used only for identification or explanation and to the owners' benefit, without intent to infringe.

Specifications and information contained in this manual are furnished for informational use only, and are subject to change at any time without notice, and should not be construed as a commitment by Graphic Products. Graphic Products assumes no responsibility or liability for any errors or inaccuracies that may appear in this manual.



Home of DuraLabel™

Contents

| | |
|---|-----------|
| 1. Introduction | 3 |
| 2. Warranties | 4 |
| 2.1 5-Year DuraLabel Printer Warranty | 4 |
| 2.1.1 Repairs | 4 |
| 2.1.2 Batteries | 4 |
| 2.1.3 Warranty Details | 4 |
| 2.2 5-Year DuraLabel Premium Vinyl Warranty | 5 |
| 3. Safety Instructions | 6 |
| 4. Getting to Know Your Toro | 7 |
| 4.1 Operating System | 7 |
| 4.2 Control Panel | 7 |
| 4.3 Connection Panel | 8 |
| 4.4 Keyboard | 9 |
| 4.4.1 Keyboard Release | 9 |
| 4.4.2 Keyboard Positions and Toro Modes | 9 |
| 4.5 Screen | 10 |
| 5. Loading Ribbon and Label Stock | 11 |
| 5.1 Loading Ribbon | 11 |
| 5.2 Loading Label Stock | 12 |
| 6. Toro Main Screen | 13 |
| 6.1 Toolbar | 13 |
| 7. Advanced Functions | 15 |
| 7.1 Using the USB Drive | 15 |
| 7.1.1 Windows Systems | 15 |
| 7.1.2 Linux Systems | 15 |
| 7.2 Touchscreen Calibration | 15 |
| 7.3 Installing Programs | 16 |
| 7.4 Password Protection | 16 |
| 7.5 Installing an External Pointing Device | 16 |
| 7.6 Recovering Templates | 16 |
| 7.6.1 Windows Systems | 16 |
| 7.6.2 Linux Systems | 17 |
| 7.7 Sleep Mode | 17 |
| 7.7.1 Windows Systems | 17 |
| 7.7.2 Linux Systems | 17 |
| 8. Wi-Fi Connection | 18 |
| 9. Battery (Optional) | 19 |
| 9.1 Battery Loading | 19 |
| 9.2 Charging the Battery | 19 |
| 9.3 Battery Maintenance | 19 |

CONTENTS

| | |
|--|-----------|
| 10. Connect to an External Monitor (Optional) | 20 |
| 11. Cleaning Your Toro | 23 |
| 12. Troubleshooting | 24 |
| 13. Specifications | 27 |
| 13.1 Printer | 27 |
| 13.2 Indicators & Buttons | 27 |
| 13.3 Communication Interface | 27 |
| 13.4 Power Requirements | 27 |
| 13.5 Capabilities | 27 |
| 13.6 Environment | 28 |
| 13.7 Label Stock | 28 |
| 13.8 Ribbon Supply | 28 |
| 13.9 Printer Body | 28 |
| 14. End User License Agreement | 29 |
| 15. Certifications | 33 |

1. Introduction

With your DuraLabel Toro, producing custom labels and signs is fast and easy. Its powerful software expands your creative capabilities and simplifies safety compliance. This versatile, go-anywhere printer comes with a built-in keyboard, mouse and touchscreen for your convenience.

Because your Toro is a standalone system, you can take it to a remote site, or place it on a cart and use it anywhere in your facility.

An optional battery provides three hours of continuous printing capability, even when there is no power outlet nearby. Additional options include an Ethernet port for shared printing, and a Wi-Fi expansion for full networking capability.



2. Warranties

2.1 5-Year DuraLabel Printer Warranty

Graphic Products' DuraLabel printers are warranted to be free from defects in materials and workmanship for a period of five (5) years from the date of purchase. Within this period, Graphic Products, Inc. will, at its sole option, repair or replace any components which fail in normal use. Such repairs or

replacement will be made at no charge to the purchaser for parts or labor, provided that the purchaser shall be responsible for any transportation cost. This warranty does not cover loss, damages from accident, or equipment or parts which have been misused, altered, neglected, carelessly handled, used for purpose other than those for which the printer was manufactured, or damages resulting from unauthorized service.



2.1.1 REPAIRS

Repairs are warranted for 90 days. If the original warranty is still in effect, repaired units will remain under their original warranty or for 90 days from the date of service, whichever is longer.

2.1.2 BATTERIES

The optional battery packs for the DuraLabel Toro and Lobo portable systems are warranted for three years from the date of purchase.

The battery for the DuraLabel 2000 PLUS system is warranted for one year from the date of purchase.

2.1.3 WARRANTY DETAILS

The warranties and remedies contained herein are exclusive and in lieu of all other warranties whether express, implied, or statutory, including any liability arising under any warranty of merchantability or fitness for a particular purpose, statutory or otherwise. This warranty gives the purchaser specific legal rights, which may vary from state to state.

In no event shall Graphic Products be liable for any incidental, special, indirect, or consequential damages, whether resulting from the use, misuse, or inability to use the product for any reason including defect. Some states do not allow the exclusion of incidental or consequential damages, so the above limitation may not apply in all areas.

Graphic Products retains the exclusive right within all warranty periods to repair, replace, or offer a full refund of the purchase price at its sole discretion. Such remedy shall be the purchaser's sole and exclusive remedy for any breach of warranty.

General maintenance and cleaning of the DuraLabel printer is the purchaser's responsibility and is not covered by the warranty. Expendable items or parts such as label supply and ribbon are not covered by this warranty.

NOTE: Specific preparation may be required before shipping. Please contact your Graphic Products representative to ensure correct return procedure: please call 800.788.5572 for details. Graphic Products, Inc. shall not be responsible for any loss or damages incurred during shipping.

2.2 5-Year DuraLabel Premium Vinyl Warranty

DuraLabel supplies are tested for durability under various conditions, including UV exposure, moisture, heating and cooling cycles, abrasion, and chemical exposures. Graphic Products warranties labels made from its Premium vinyl supplies for a period of five (5) years.

Within five years of purchase and after proper application, Graphic Products will replace labels made with DuraLabel Premium Vinyl which become unreadable or fail to maintain adhesion with the labeled surface. In such instance, Graphic Products, Inc. will provide a one-time replacement roll of the same supply.

3. Safety Instructions

Please review the following safety instructions before using the printer:



- Keep printer away from humidity and ultraviolet radiation. Toro is intended for indoor use only.
- Check power source voltage before connecting printer to power outlet.
- Disconnect printer from power source when not in use.
- DO NOT pour liquid onto the printer or printer parts.
- ONLY qualified service personnel should attempt to repair printer.
- DO NOT repair or adjust energized equipment without supervision. A person capable of providing first aid must always be present.
- Toro supply may build a small static charge in static-sensitive environments. DO NOT operate Toro near flammable materials.
- Power outlet should be near printer and easily accessible for quick power disconnect.
- Use only with power supply model WDS120240.
- Remove Toro's battery and unplug unit from wall socket to completely disconnect power.

NOTE: Changes or modifications not expressly approved by the party responsible for compliance could void the user's authority to operate the equipment.

4. Getting to Know Your Toro

4.1 Operating System

Due to different licensing agreements, some Toro systems use Microsoft Windows XP Embedded™ software, while others use Ubuntu Linux™ software. The functions of the two system types are only slightly different, and are described in this User Guide.

To identify the operating system in use on your DuraLabel Toro, press the system information icon  on your toolbar. In the lower right part of this window, you will see the name of the operating system in place on your Toro. If your DuraLabel Toro uses Ubuntu Linux the system also includes a list of preferred fonts, which can be found by pressing the help icon  on the toolbar and then pressing the View button for Preferred Fonts. This list shows which fonts we recommend for use, and similar fonts available on Windows-based systems.

4.2 Control Panel

Toro's control panel is centered at the top of the printer.

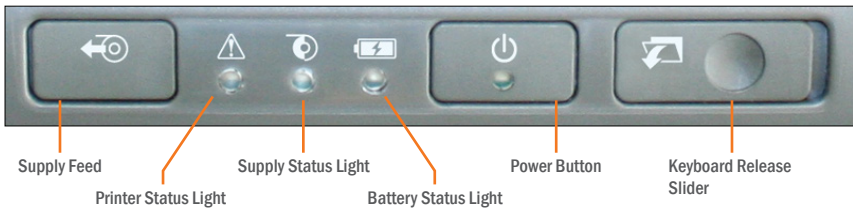

Supply Feed Button: Press this button to pause or resume a print job. If there is no current print job, you can hold this button to feed blank supply through the printer.

Printer Status Light: This light glows green to indicate normal operation, and changes color or blinks to show errors. See the Troubleshooting section for help.

Supply Status Light: If this light is red, supply is low. A blinking red light indicates supply has almost run out or no supply is loaded.

Battery Status Light: When this light is red, the battery is down to 10% of its charge. Remaining battery power will last for only a short time. (The Toro battery is an optional accessory, and is not required when using a standard power outlet.)

Power Button: Press this button to turn your Toro on or off. The indicator light will blink while Toro is starting up, shutting down, or in sleep mode; it will glow green when Toro is ready.

Keyboard Release Slider: Slide this to the right to release the keyboard from its locked, upright position.

4.3 Connection Panel

Contains Toro's power and data transfer ports.

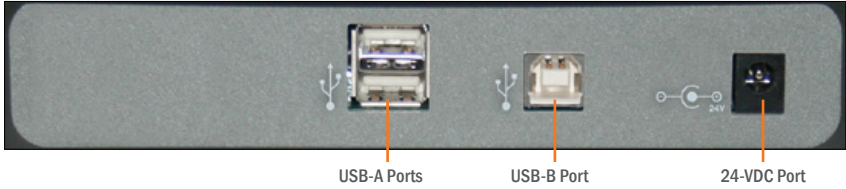

USB-A ports: The USB receiver for your mouse will be pre-installed in one of the USB-A ports. The other port may be used to plug in a USB flash drive to transfer files.

USB-B port: Use this port to connect Toro to a computer and use the system as a normal desktop printer.

Wi-Fi USB Adapter: This small USB device allows you to connect Toro to a wireless network as a workstation or shared printer.



24-VDC port: Connect the Toro power supply here.

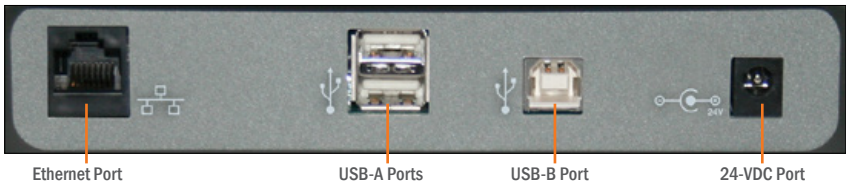

Ethernet Port (optional): If present, this port allows you to connect Toro to a network as a shared printer.

HDMI Port (optional): If present, this port allows you to connect Toro to an external monitor or other display.

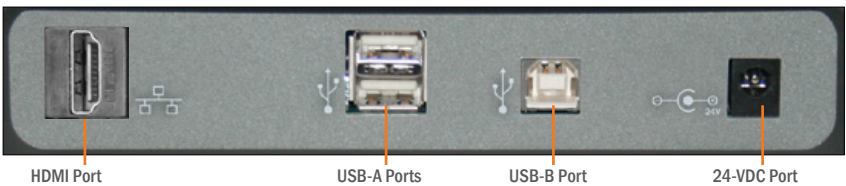

NOTE: The Toro supports communication through a USB cable no longer than three meters or 9½ feet.

4.4 Keyboard

4.4.1 KEYBOARD RELEASE

The Toro keyboard is permanently mounted to the printer housing. Open the keyboard by moving the release slider on the control panel to the right, and pulling the keyboard down until it rests on your work surface. When finished with the system, you can raise the keyboard back into its locked, upright position.



4.4.2 KEYBOARD POSITIONS AND TORO MODES

Your DuraLabel Toro has two different modes:

Standalone Mode: In this mode, Toro's touchscreen and keyboard can be used to create label designs.

Desktop Mode: In this mode, Toro will wait for print commands from a connected computer.

When the keyboard is open (showing Toro's screen) the system is in its Standalone mode. To use Desktop mode and design labels on your computer, close the keyboard (hiding Toro's screen). While in Desktop mode, Toro's internal software will be deactivated to save power. You can turn your Toro on or off while it is in either mode, and you can switch it between the two modes whenever it is not busy.

4.5 Screen

Toro includes a 9" (diagonal) screen with touch capability. You can use a fingertip or the Toro stylus (seated in the bottom-right edge of the keyboard) to design your labels.

To unlock the screen and adjust its angle, push the release button to the right of the screen. Then, lift the screen to the desired angle. The screen features four tilt positions to optimize viewing and touch accessibility. Each position is held firmly in place for finger touch and pointer use.



In addition to the touchscreen, Toro includes a wireless optical mouse. The mouse comes with a small USB receiver, which will be pre-installed into one of the USB-A ports on the Connection Panel of your Toro. The mouse uses a single AA battery and includes its own power switch; if the Toro does not respond when you use the mouse, make sure that the USB receiver is still firmly connected, that the mouse power switch is set to ON, and that the battery is still fresh.



Toro wireless optical mouse

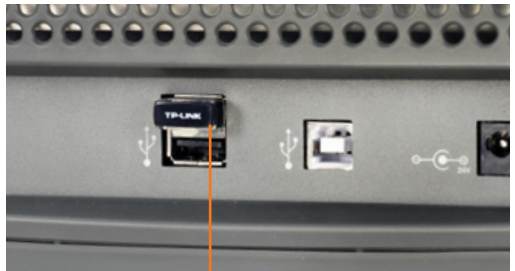

Mouse USB receiver pre-installed in USB-A port

5. Loading Ribbon and Label Stock

To load your Toro with supplies, you will need to raise the hinged cover. The cover will hold itself at the fully-opened position, which will require about 21 inches of vertical clearance.

5.1 Loading Ribbon

The printing ribbon provides the “ink” for the printing process. As labels are printed, colored resin will be transferred from the fresh ribbon onto the label stock, and the used ribbon will be collected on a take-up roller for later disposal.

1. Start with a fresh, empty ribbon take-up core. Fit one end of the core onto the gray spring-loaded holder on the top of the print head carriage. Then, fit the other end of the ribbon core onto the wheeled holder (Fig. A). Turn the take-up core or holder by hand, until the tab on the holder locks into the notch in the core.
2. Then, push the gray print head release tabs (Fig. B), to release the print head carriage. It will spring upward. Hold the new roll of ribbon so the loose end falls to the rear of the printer. Fit one end of the ribbon core onto the gray spring-loaded holder (Fig. B) on the underside of the print head carriage.
3. Then, fit the other end of the ribbon core onto the geared holder. Turn the ribbon core by hand until the tab on the holder locks into the notch in the core.
4. Pull the loose end of the ribbon up and around the print carriage and use a small piece of label stock or tape to secure the end of the ribbon to the top of the empty rewind core.
5. Pull the ribbon snug by turning the gray take-up wheel (Fig. A).

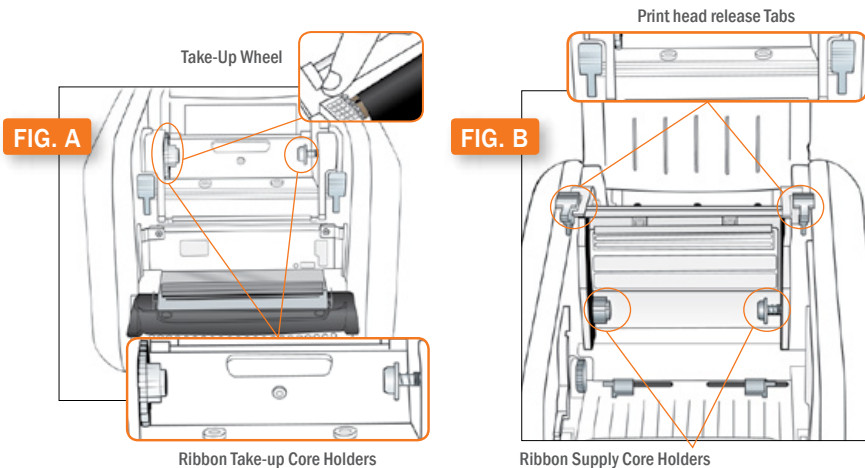

5.2 Loading Label Stock

Your label stock is the base material for your labels, or the “paper” in the printing process. For each roll of ribbon you use in the Toro, you will probably use three or four rolls of label stock.

1. If you haven't already done so, raise the print head carriage by pressing the two gray Print Head Release Tabs (Fig. B).
2. Place label supply onto the supply spindle and slide the fixing tabs onto either side (Fig. C) to hold the roll in the center of the spindle.
3. With the label supply unrolling from the top of the roll and feeding toward the print head carriage, rest the supply spindle into its slots in your Toro.
4. Feed the end of the label supply under the print carriage, threading it between and beneath the gray adjustable label guides, and over the top of the rubber roller near the cutter module.
5. Slide the gray adjustable label guides together to keep the label stock centered, but not so tight as to bend or wrinkle the label stock.
6. Close the print head carriage by pressing it down into place, and then close the Toro cover.

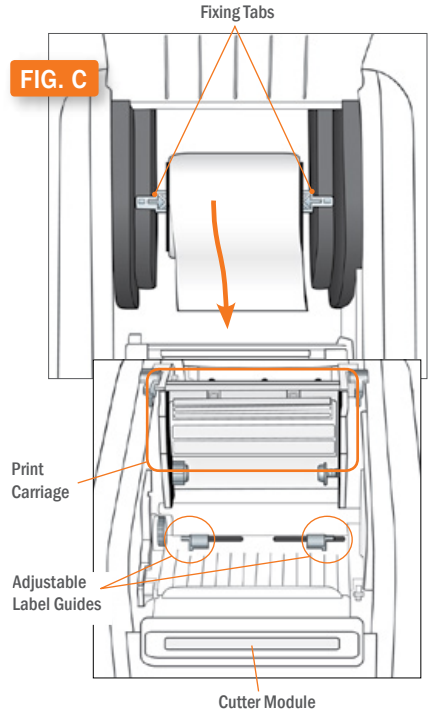

When loading supplies, you can also flip the cutter module down to provide more room. Simply pull the top edge of the cutter module away from the rest of the Toro; it will rest in its lowered position. If you lower the cutter module while changing supplies, be sure to raise it back into place before closing the Toro lid.

6. Toro Main Screen

The Toro main screen appears when you turn the system on. Most of the common functions of your Toro can be reached through the toolbar along the top of this screen.



Toro main screen

6.1 Toolbar



- 1. SOFTWARE SHORTCUT ICONS:** At the left side of the toolbar, you will see icons for your label design software. For users in the United States, Toro comes loaded with DuraSuite for creating labels in a variety of standardized formats, such as GHS labels, NFPA Diamond labels, Arc Flash labels, or Pipe Markers. Toro also includes LabelForge for creating completely customized label designs from scratch, using a simple interface. Each of these programs is covered in more detail in its own User Guide.
- 2. GP COMMUNITY ICON:** If your Toro has Wi-Fi enabled, this icon will appear, letting you quickly access the GP Community.
- 3. TEMPLATES:** The Templates menu allows you to easily browse pre-made templates that are provided with your Toro. The templates are organized into categories.
- 4. PROGRAMS:** The Programs menu provides access to the different software and system controls on your Toro.

D DRIVE: On a Windows system, this button allows you to browse the backup and data folders on your Toro system. On a Linux system, this button will be replaced by a “DATA” icon on the desktop.

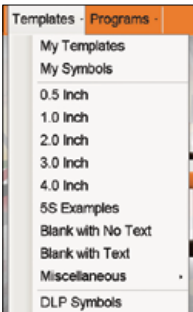
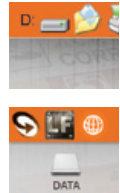

Templates drop-down menu

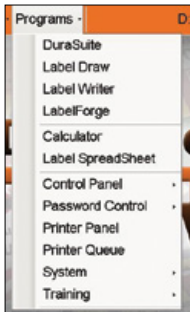

Programs drop-down menu

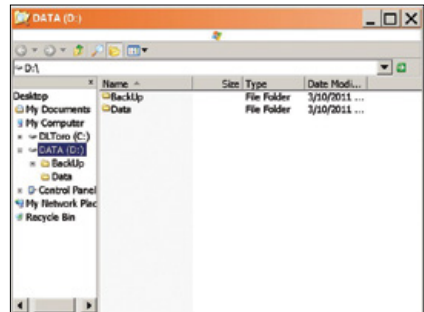

Toro D drive window

5. **MY DOCUMENTS:** Use this to browse your commonly-used templates, label designs, or images. Most of your created files will be saved here.
6. **PRINTER SETTINGS:** This button opens the Printer Settings window, where you can adjust common Toro system settings or access more advanced ones.

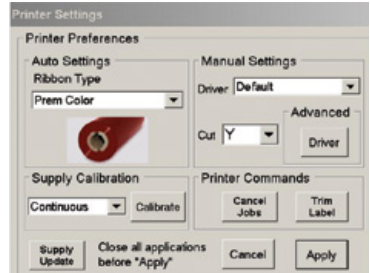

Printer Settings window

If you change ribbon types, you will need to select the current ribbon under “Ribbon Type” in this window. Different ribbon types will have a color-coded marking on the end of the ribbon core:

- Black Core** - premium black ribbon
- Blue Core** - petroleum-resistant ribbon
- Red Core** - extreme chemical-resistant ribbon
- Green Core** - custom ribbon
- Orange Core** - black shrink tube ribbon
- Plain Core** - white, red, green, orange, yellow, dark blue

If you change from one type of label stock to another, you may need to select the current supply type in the “Supply Calibration” section.

Continuous: an uninterrupted, continuous roll of label stock (the most common supply type)

Black Mark: a roll of partially pre-printed labels, with black marks on the backing to distinguish one label from the next

Die-Cut: a roll of pre-cut labels, usually pre-printed with some elements, with small gaps between labels

7. **SUPPLY INFORMATION:** This icon fills with green to show approximately how much of your label stock is left. Clicking on the icon will open a window with more details about the supply.
8. **BATTERY STATUS:** If Toro is using a battery, the approximate level of charge remaining will be shown here.
9. **HELP:** This icon gives you access to training materials, including instructional videos, manuals, how-to demonstrations and label examples.
10. **SYSTEM INFORMATION:** Click on this icon to view the contact information for customer support, supply ordering, or product updates, as well as details on your Toro system and its software.
11. **POWER BUTTON:** Use this button to power down your Toro system. The physical button on the Control Panel will have the same effect.
12. **DATE AND TIME:** If the displayed time is incorrect, click on the time to open the time settings window.

7. Advanced Functions

7.1 Using the USB Drive

To copy files such as images or templates onto your Toro system, load the files onto a USB flash drive or similar storage device, and connect it to an unused USB-A port on your Toro.

7.1.1 WINDOWS SYSTEMS

A button labeled E: will appear on the Toro toolbar. Click this button to view the contents of the USB drive. You can drag and drop files to the desired location using the folder tree to the left of the window.

7.1.2 LINUX SYSTEMS

A new desktop icon will appear on the Toro desktop. Double click this icon to view contents of the USB drive. Drag and drop files to the desired location using the file browser or to the desktop.

NOTE: Any files that you want to keep on your Toro system should be saved to the My Documents folder (on Windows systems) or the /home/dltoro folder (on Linux systems). This is the default location for all user-created files, including saving new or modified templates, images, and other documents. Files changed, deleted, moved or modified in other parts of the Toro system will automatically revert to their original state the next time Toro is powered on.

7.2 Touchscreen Calibration

Your Toro touchscreen may need to be calibrated occasionally to improve touch performance. To calibrate the Toro touchscreen, select Control Panel from the Programs menu on the toolbar, then select Touch Calibration. Press the x that appears in a corner of your screen. When you hear a beep and the x stops blinking, a new x will appear in a different corner. When four x's have been pressed, your screen will be calibrated for optimum touch accuracy.



7.3 Installing Programs

Additional programs cannot be installed or run on your Toro; only manufacturer-supplied updates can be installed. If you would like to use other software, you can use Toro as a desktop label printer by connecting it to your computer with a standard USB cable. (If your Toro is equipped with the optional Ethernet port or Wi-Fi expansion, you can also set up Toro as a shared network printer.) Once you have installed the Toro printer driver on your computer, you will be able to print from many different programs.

7.4 Password Protection

By default, Toro does not require a username or password. To enable Toro's password protection option, select the Programs menu from the toolbar, highlight Password Control, and choose Add User. Complete the information in the Add User window that appears, then click Enable Lock. The next time Toro is started (or wakes from its Sleep Mode), a log-in prompt will be displayed, and a valid username and password will be required. To immediately lock the station, select Programs, then Lock Station Now.

Once a user has been added, the Password Control menu will have additional options to delete a user, change a password, or disable/enable password protection. If your Toro is locked and all passwords are lost or forgotten, contact your DuraLabel representative.

7.5 Installing an External Pointing Device

Toro supports most USB-compatible pointing devices, such as ordinary computer mice and trackballs. To install a pointing device, plug it into an available USB-A port on your Toro. The system will automatically recognize the new device.

7.6 Recovering Templates

Toro retains a backup copy of all original manufacturer-supplied label templates. If changes were made to an original template but the unchanged one is needed, follow these steps to replace the edited template with the original:

7.6.1 WINDOWS SYSTEMS

- Click the hard drive icon on the Toro toolbar.
- Browse to the folder C:\GraphicProducts\BackUp\DLP Templates and Symbols.
- Drag and drop the template file to the same folder as the modified copy in C:\Documents and Settings\Default User\My Documents\DLP Templates and Symbols.
- Click OK at the prompt to overwrite the edited template with the original.

7.6.2 LINUX SYSTEMS

- Double-click on the DATA icon on the desktop.
- Navigate to /home/dltoro/Desktop/DATA/Backup/DLP Templates and Symbols.
- Drag and drop the template file to the same folder as the modified copy in /home/dltoro/Documents/DuraLabel Templates/DLP Templates and Symbols.
- Click Replace at the prompt to overwrite the edited template with the original.

An entire template folder may be recovered using the same procedure.

7.7 Sleep Mode

In sleep mode, user data is saved to memory and the Toro appears to be off. The power indicator light will slowly blink green. To leave sleep mode, press any key, such as the spacebar.

7.7.1 WINDOWS SYSTEMS

To enable sleep mode, select the Programs menu from the taskbar, highlight Control Panel, highlight All Settings, and choose Power Options. Select the Power Schemes tab from the Power Options window that appears, and select the desired time in the System standby box. Your selection will be implemented the next time Toro starts up.

7.7.2 LINUX SYSTEMS

To enable sleep mode, select the Programs menu from the taskbar, highlight Control panel, highlight All Settings, and choose Power Options. Select the On AC Power tab from the Power Options window that appears, and choose "Put computer to sleep when inactive..."; then, choose the desired wait time.

8. Wi-Fi Connection

Toro's Wi-Fi networking is an optional expansion. The wireless networking capabilities allow you to share Toro over a wireless network, or access information over a network for the labels you design on the Toro.

To connect your Toro to a wireless network, follow these steps.

1. In Toro's Programs menu, highlight Control Panel and choose All Settings.
2. In the Control Panel, click Network.
3. On the left side of the Network window, select Wireless.
4. The dropdown menu for Network Name will show you the available wireless networks. Choose a network.

Once you are connected to a wireless network, you can choose to have Toro automatically reconnect to that network.

9. Battery (Optional)

Toro's battery is an optional accessory. The Lithium-Ion (Li-ion) battery lets you design and print labels on the go, even without an AC power supply. Typically, a fully-charged battery will allow for about three hours of continuous printing, or 30 hours of sleep mode.

A Toro battery can usually be fully recharged in about three hours. During charging, make sure to put the battery on a clean, dry surface, away from heat or direct sunlight. Because Lithium batteries self-discharge over time, it is recommended that you fully recharge the battery at least once every three months.

9.1 Battery Loading

The battery mounts into the back of the Toro. Remove the battery cover door by pushing the slider downward and pulling the door away. Position the battery so the cut-outs are aligned and the contacts are in position with the contact interface. Push the battery in until it locks into place.

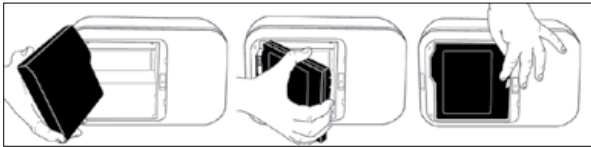

9.2 Charging the Battery

The Toro battery should be charged only with the charging unit provided. Plug the charging unit into the Toro battery and place the battery on a clean and dry surface. Then, plug the charger into an AC outlet. The light on top of the charger will glow red. When the charger light turns green, the charge is complete. A typical charging time is three hours; do not leave the battery connected to the charger for more than 24 hours at a time.

9.3 Battery Maintenance

When the battery is not in use, keep it in a cool, dry place, away from heat or direct sunlight. Do not disassemble your Toro battery. Do not let the metal battery pins come into contact with another metal surface. If you notice any unusual odor, leakage, or swelling in the Toro battery, discontinue use and contact your DuraLabel representative.

10. Connect to an External Monitor (Optional)

One of Toro's optional expansions is an HDMI port, which allows you to connect your Toro to an external monitor or other display. To use this function, **your Toro will need to be powered on before you plug in the HDMI cable**. Do not connect the HDMI cable until instructed.

- 1. Once Toro has started up, Toro's built-in touchscreen will show an orange toolbar along the top of the screen.



- 2. Using the wireless mouse, right click on an empty part of the Toro desktop. In the menu that appears, choose "Change Desktop Background."



- 3. In the top left corner of the Appearance window, click "All Settings."



- 4. In the Hardware section of this System Settings window, select "Displays."

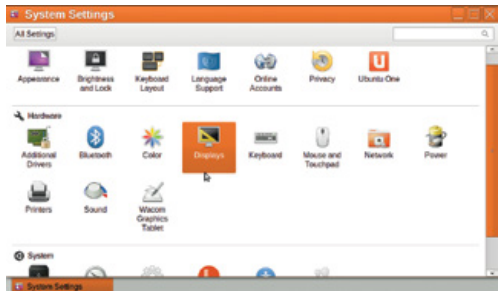

CONNECT TO AN EXTERNAL MONITOR (OPTIONAL)

5. Confirm that you see only one display, as shown here.

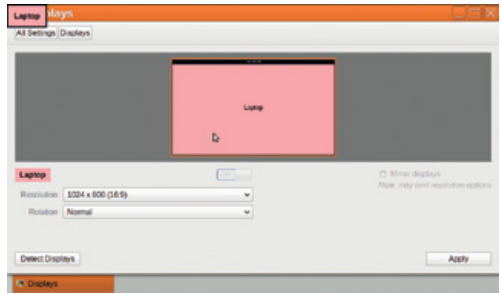

6. Plug the HDMI end (flat and narrow) of the included cable into your Toro. Plug the DVI end into your external monitor or other display. (You can also use a standard HDMI cable, or a DVI to VGA adapter, if necessary; these are not included with your Toro.)



7. Once the cable connects your Toro and your external monitor, a second display will be shown in the Displays window on your Toro. Make sure that the "Laptop" box is selected, and click the On/Off toggle button.

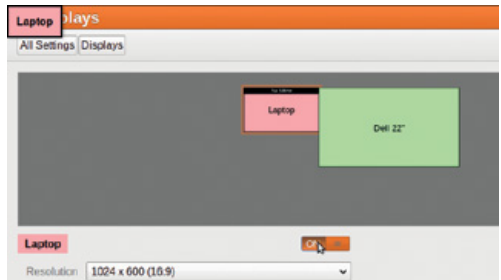

8. When the button shows "Off," click Apply. The Toro's built-in touchscreen will go black, and your external monitor will be activated instead.

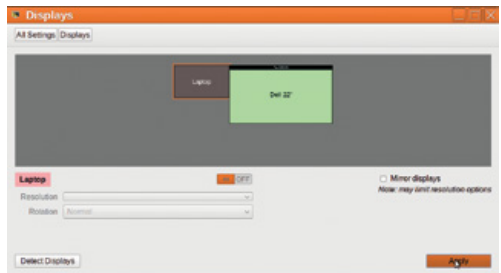

CONNECT TO AN EXTERNAL MONITOR (OPTIONAL)

9. You should see this prompt on your external monitor. If the display appears correctly, click “Keep This Configuration.” Otherwise, the previous display settings will be restored automatically after about twenty seconds.

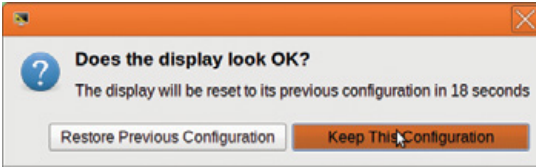

NOTE: If your monitor isn't displaying anything, verify everything is connected and that your monitor is set to DVI as the Input Source.

10. At this point, you will be able to use your Toro with the external monitor.



Your new display settings will be saved in your Toro. You can disconnect and reconnect this external monitor without reconfiguring any settings, and your system will automatically switch between using the external monitor and Toro's built-in touchscreen. If you connect a different display, you may need to follow these steps again.

11. Cleaning Your Toro

IMPORTANT! Always turn the power OFF and remove the battery before cleaning or performing maintenance. Wait at least 5 seconds before turning ON the power. Basic cleaning of the print head, cutter and platen roller will extend the life of the printer and allow crisp, clear labels and signs with every printing.

Dust, residue, or adhesive on the print head can result in an unclear printout. Keep the top cover closed when printing.

1. Turn the printer power OFF. Remove the battery, if one is being used.
2. Open the printer cover, raise the print head mechanism, and remove the ribbon and label supply from the printer.
3. Open one of the individually-packaged cleaning swabs, or lightly moisten a soft cloth with isopropyl alcohol (isopropanol).
4. Gently rub the swab or cloth back and forth across the front and underside of the print head to remove any built-up adhesive or residue.
5. Run the swab or cloth between and around the gray adjustable label guides to clear any dust or adhesive build-up.
6. Finally, use the swab or cloth to clean both sides of the cutter blade by gently inserting it into the slot in the cutter module and sliding it from side to side. The cutter module can be flipped forward to make the back easier to reach.
7. If the cutter still carries adhesive build-up, you can temporarily separate the metal cutter assembly from its plastic faceplate. With the cutter flipped forward, remove the three Phillips-head screws (one at the top of the slot and one on each side of the module). You will now be able to reach the front side of the cutter blades more easily. (Be careful when the plastic faceplate is removed, as the cutter blades are sharp and could cause minor injury.) Be sure to put these screws back in place when you are finished cleaning the system.

12. Troubleshooting

For most common system errors, Toro will show an image that explains the problem and how to resolve it.

For printing errors where no error message appears, see these recommendations, or call your DuraLabel representative for support.

Toro prints my labels, but cuts them in the wrong place.

Print settings may be incorrect. Save and close your label design, and click the printer icon in the Toro taskbar to open the printer settings. Under Supply Calibration, check that the selection matches the loaded label stock:

- Continuous (a roll of uninterrupted stock)
- Black Mark (a roll of pre-printed label stock, with black marks on the backing between labels)
- Die-Cut (a roll of pre-cut labels, ready to peel off individually)

Once the setting is correct, click the Calibrate button. Toro will feed some of the supply through and re-adjust its internal sensors. (Once the feed stops, you can open the cover, raise the print head carriage, and wind the supply back in.) Apply the changes, reopen your label design, and try printing again.

Toro feeds out label stock, but nothing is printed on it.

The ribbon may be loaded facing the wrong way. Open Toro's lid and raise the print head carriage, as if you were going to load a fresh ribbon. Make sure that the ribbon unrolls from the back of the fresh ribbon core on the underside of the print head carriage. Each ribbon has a "shiny" side and a "dull" side; the "dull" side should be showing. From the fresh ribbon core, the ribbon should pull forward to run across the metal print head and over onto the top of the ribbon take-up core. Each core should lock into place when it is properly positioned.

When you are finished correcting the supply loading, lower the print head carriage, close the cover, and try printing again.

My label is printed, but there are blank specks across the printed area.

This can be caused by dust in the printer, on the print head, or on the label stock, especially if your Toro or supplies are stored in the open. We recommend cleaning the printer after every two or three rolls of label stock; now may be a good time. It will also help to keep your supplies closed in their boxes when not in use.

There is a red “X” over the supply icon on the Toro main screen toolbar.

Either no label stock is loaded, or Toro is having trouble detecting the label stock. If you have label stock loaded and need to print, click on the printer icon in the Toro main screen toolbar, and click the button for “Supply Update” in the lower left corner of the Print Settings window. Toro will attempt to re-detect the supply.

The “!” light is glowing red.

Toro is not ready to print. Usually, this is because the print head carriage is not fully latched down; open the cover and press firmly on the textured areas at the top of the print head carriage. The light will change to solid green when the system is ready to print.

The “!” light is blinking red, but there is no error message on the screen.

Toro is paused. Press the Pause/Feed button on Toro’s Control Panel; the light should change to solid green, and any waiting labels should be printed.

The connected display is showing black bars on the left and right sides of the background.

This happens when the resolution for your display isn’t set correctly. To correct this setting:

1. Open the Displays window. (Follow steps 1 through 4 of the External Monitor Setup.)
2. Select your external monitor.
3. In the drop-down menu for resolution, select the highest available resolution (typically at the top of the list).

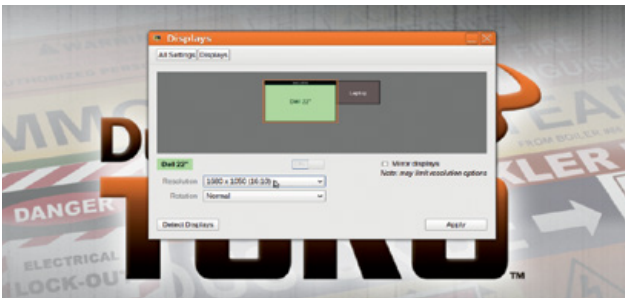

When unplugging the HDMI Cable from the back of the Toro, the Toro Screen stays Black.

This happens when Toro is still trying to send the display output through the HDMI connection.

1. Plug the HDMI cable back into Toro, and wait 10 seconds. Then, disconnect the cable again.
2. If Toro's built-in touchscreen is still black, plug the HDMI cable back into Toro and save any label designs or other work. Unplug the HDMI cable, and fold up Toro's keyboard to cover the built-in touchscreen. Wait 10 seconds, and push the keyboard release slider to the right and swing the keyboard down again. Toro's display settings will be reloaded.

NOTE: If you have any questions, please contact Graphic Products for technical support by calling **800.788.5572** or visiting ***GraphicProducts.com***.

13. Specifications

13.1 Printer

- Type: Thermal Transfer
- Print Speed: up to 3" per second
- Resolution: 300 dots per inch
- Max. Print Width: 4.0"
- Max. Print Length: 30" using Label Writer software
- Unlimited length using DuraSuite software and EXT cut setting

13.2 Indicators & Buttons

- Indicators: Power, Printer Status, Supply Status, Battery Status
- Buttons: Power, Supply Feed, Keyboard Release, Screen Release, Battery Release

13.3 Communication and Data Storage

- Communications: USB 2.0 (2x USB-A, 1x USB-B), Wi-Fi USB adapter, Optional Ethernet port,
- Data Storage: 4GB Flash (long-term), 1GB SDRAM (short-term)

13.4 Power Requirements

- Input Voltage: 24 VDC, 5A
- Different AC adapters available for worldwide usage

13.5 Capabilities

- Create, edit, save, and print label designs with internal software
- Open and print designs created with common software (including support for .DOC/.DOCX and .PDF formats)
- Lock system with user passwords
- No user software may be installed

13.6 Environment

- Operating Temperature: 41 °F – 104 °F (5 °C – 40 °C)
- Operation Humidity: 30% – 85%, non-condensing
- Storage Temperature: -4 °F – 122 °F (-20 °C – 50 °C)
- Storage Humidity: 10% – 90%, non-condensing
- Ventilation: Fan mounted on circuit board

13.7 Label Stock

- Type: Continuous, Black Mark & Die-Cut
- Width: 0.20" minimum, 4" maximum

13.8 Ribbon Supply

- Premium Resin
- Width: 106 mm (4.17 inch)
- Capacity: 360' with 0.5" core diameter

13.9 Printer Body

- Dimensions: 13.5"W x 10.25"D x 8.5"H
- 13.8 lbs (6.26 kg), excluding supplies

Toro specifications are subject to change without notice.

14. End User License Agreement

(Applies to Microsoft Windows systems only)

Microsoft XP – Embedded Device

You have acquired a device (“DEVICE”) that includes software licensed by Graphic Products, Inc. from Microsoft Licensing, GP or its affiliates (“MS”). Those installed software products of MS origin, as well as associated media, printed materials, and “online” or electronic documentation (“SOFTWARE”) are protected by international intellectual property laws and treaties. The SOFTWARE is licensed, not sold. All rights reserved.

IF YOU DO NOT AGREE TO THIS END USER LICENSE AGREEMENT (“EULA”), DO NOT USE THE DEVICE OR COPY THE SOFTWARE. INSTEAD, PROMPTLY CONTACT GRAPHIC PRODUCTS, INC. FOR INSTRUCTIONS ON RETURN OF THE UNUSED DEVICE FOR A REFUND. ANY USE OF THE SOFTWARE, INCLUDING BUT NOT LIMITED TO USE ON THE DEVICE, WILL CONSTITUTE YOUR AGREEMENT TO THIS EULA (OR RATIFICATION OF ANY PREVIOUS CONSENT).

GRANT OF SOFTWARE LICENSE. This EULA grants you the following license:

- **LIMITATION ON USE.** You may use the SOFTWARE only on the DEVICE.
- **SUITABILITY.** THE SOFTWARE IS NOT FAULT TOLERANT. GRAPHIC PRODUCTS, INC. HAS INDEPENDENTLY DETERMINED HOW TO USE THE SOFTWARE IN THE DEVICE, AND MS HAS RELIED UPON GRAPHIC PRODUCTS TO CONDUCT SUFFICIENT TESTING TO DETERMINE THAT THE SOFTWARE IS SUITABLE FOR SUCH USE.
- **NO WARRANTIES FOR THIS SOFTWARE.** THE SOFTWARE IS PROVIDED “AS IS” AND WITH ALL FAULTS. THE ENTIRE RISK AS TO SATISFACTORY QUALITY, PERFORMANCE, ACCURACY, AND EFFORT (INCLUDING LACK OF NEGLIGENCE) IS WITH YOU. ALSO, THERE IS NO WARRANTY AGAINST INTERFERENCE WITH YOUR ENJOYMENT OF THE SOFTWARE OR AGAINST INFRINGEMENT. IF YOU HAVE RECEIVED ANY WARRANTIES REGARDING THE DEVICE OR THE SOFTWARE, THOSE WARRANTIES DO NOT ORIGINATE FROM, AND ARE NOT BINDING ON, MS.
- **NO LIABILITY FOR CERTAIN DAMAGES.** EXCEPT AS PROHIBITED BY LAW, MS SHALL HAVE NO LIABILITY FOR ANY INDIRECT, SPECIAL, CONSEQUENTIAL OR INCIDENTAL DAMAGES ARISING FROM OR IN CONNECTION WITH THE USE OR PERFORMANCE OF THE SOFTWARE. THIS LIMITATION SHALL APPLY EVEN IF ANY REMEDY FAILS OF ITS ESSENTIAL PURPOSE. IN NO EVENT SHALL MS BE LIABLE FOR ANY AMOUNT IN EXCESS OF U.S. TWO HUNDRED FIFTY DOLLARS (U.S.\$250.00).
- **LIMITATIONS ON REVERSE ENGINEERING, DECOMPILATION, AND DISASSEMBLY.** You may not reverse engineer, decompile, or disassemble the SOFTWARE, except and only to the extent that such activity is expressly permitted by applicable law notwithstanding this limitation.

- **SOFTWARE TRANSFER ALLOWED BUT WITH RESTRICTIONS.** You may permanently transfer rights under this EULA only as part of a permanent sale or transfer of the DEVICE, and only if the recipient agrees to this EULA. If the SOFTWARE is an upgrade, any transfer must also include all prior versions of the SOFTWARE.
- **EXPORT RESTRICTIONS.** You acknowledge that SOFTWARE is subject to U.S. export jurisdiction. You agree to comply with all applicable international and national laws that apply to the SOFTWARE, including U.S. Export Administration Regulations, as well as end-user, end-use and destination restrictions issued by U.S. and other governments. For additional information see <http://www.microsoft/exporting/>.
- **LIMITED USE OF PARTICULAR SOFTWARE SERVICES.** Provided that the DEVICE continues to comply with the terms of the “Restricted Functionality” paragraph below, without limiting the number of computers or other electronic devices that might connect to the DEVICE to access or utilize other software or SOFTWARE services on the DEVICE, you may permit a maximum of ten (10) computers or other electronic devices to connect to the DEVICE to utilize the services of the SOFTWARE for (a) file and print services, (b) internet information services, and/or (c) remote access (including connection sharing). The ten (10) connection maximum includes any indirect connections made through “multiplexing” or other software or hardware which pools or aggregates connections.
- **CLIENT ACCESS LICENSE MAY BE REQUIRED.** If you use the DEVICE to access or utilize the services or functionality of Microsoft Windows Server products (such as Microsoft Windows NT Server 4.0 (all editions) or Microsoft Windows 2000 Server (all editions)), or use the DEVICE to permit workstation or computing devices to access or utilize the services or functionality of Microsoft Windows Server products, you may be required to obtain a Client Access License for the DEVICE and/or each such workstation or computing device. Please refer to the end user license agreement for your Microsoft Windows Server product for additional information.
- **RESTRICTED DEPLOYMENT.** The SOFTWARE is not designed or intended for use or resale in hazardous environments requiring fail-safe performance, such as in the operation of nuclear facilities, aircraft navigation or communication systems, air traffic control, or other devices or systems in which a malfunction of the SOFTWARE would result in foreseeable risk of injury or death to the operator of the device or system, or to others.
- **RESTRICTED FUNCTIONALITY.** You are licensed to use the SOFTWARE to provide only the limited functionality (specific tasks or processes) for which the DEVICE has been designed and marketed by Graphic Products, Inc. This license specifically prohibits any other use of the SOFTWARE, or inclusion of additional software programs or functions, on the DEVICE. Subject to the terms of the “Limited Use of Particular Services” paragraph above, you may use the SOFTWARE on the DEVICE to interact with other computers or electronic devices.

- **MAXIMUM NUMBER OF PROCESSORS.** The SOFTWARE may not be used by more than two (2) processors at any one time on the DEVICE.
- **SECURITY UPDATES.** Content providers are using the digital rights management technology (“Microsoft DRM”) contained in this SOFTWARE to protect the integrity of their content (“Secure Content”) so that their intellectual property, including copyright, in such content is not misappropriated. Owners of such Secure Content (“Secure Content Owners”) may, from time to time, request MS, Microsoft Corporation or their subsidiaries to provide security related updates to the Microsoft DRM components of the SOFTWARE (“Security Updates”) that may affect your ability to copy, display and/or play Secure Content through the Microsoft software or third party applications that utilize Microsoft DRM. You therefore agree that, if you elect to download a license from the internet which enables your use of Secure Content, MS, Microsoft Corporation or their subsidiaries may, in conjunction with such license, also download onto your DEVICE such Security Updates that a Secure Content Owner has requested that MS, Microsoft Corporation or their subsidiaries distribute. MS, Microsoft Corporation or their subsidiaries will not retrieve any personally identifiable information, or any other information, from your DEVICE by downloading such Security Updates.
- **CONSENT TO USE OF DATA.** You agree that MS, Microsoft Corporation and their affiliates may collect and use technical information gathered in any manner as part of product support services related to the SOFTWARE. MS, Microsoft Corporation and their affiliates may use this information solely to improve their products or to provide customized services or technologies to you. MS, Microsoft Corporation and their affiliates may disclose this information to others, but not in a form that personally identifies you.
- **ADDITIONAL SOFTWARE/SERVICES.** The SOFTWARE may permit Graphic Products, Inc., MS, Microsoft Corporation or their affiliates to provide or make available to you SOFTWARE updates, supplements, or add-on components of the SOFTWARE after the date you obtain your initial copy of the SOFTWARE (“Supplemental Components”).
- **SUPPLEMENTAL COMPONENTS.** If Graphic Products, Inc. provides or makes available to you Supplemental Components and no other EULA terms are provided along with the Supplemental Components, then the terms of this EULA shall apply.
- **LICENSOR OF THE SUPPLEMENTAL COMPONENT(S).** If MS, Microsoft Corporation or their affiliates make available Supplemental Components, and no other EULA terms are provided, then the terms of this EULA shall apply, except that the MS, Microsoft Corporation or affiliate entity providing the Supplemental Component(s) shall be the licensor of the Supplemental Component(s).

- **WINDOWS MEDIA FORMAT SOFTWARE DEVELOPMENT KIT.** This EULA does not grant you any rights to use the Windows Media Format Software Development Kit (“WMFSDK”) components contained in the SOFTWARE to develop a software application that uses Windows Media technology. If you wish to use the WMFSDK to develop such an application, visit <http://msdn.microsoft.com/workshop/media/windowsmedia/sdk/wmsdk.asp>, accept a separate license for the WMFSDK, download the appropriate WMDSK, and install it on your system.

Other Software

Toro includes, in addition to Microsoft software, the following licensed software:

- **Adobe Reader 9.0®** - Use of Adobe Reader is subject to the End User License Agreement available online at <http://www.adobe.com/products/eulas/>
- **OpenOffice.org Writer, OpenOffice.org Draw, and OpenOffice.org Calculator** - This product is made available subject to the terms of GNU Lesser General Public License Version 3.0. A copy of the LGPL license can be found at <http://www.openoffice.org/license.html>
- **VLC** - This product is made available subject to the terms of GNU General Public License Version 2. A copy of the license can be found at <http://www.videolan.org/legal.html>

15. Certifications

FCC Compliance - This equipment has been tested and found to comply with the limits for a CLASS A digital device, pursuant to Part 15 of the FCC Rules. Operation is subject to the following two conditions: (1) This device may not cause harmful interference, and (2) this device must accept any interference received, including interference that may cause undesired operation. These limits are designed to provide reasonable protection against harmful interference when the equipment is operated in a commercial environment. This equipment generates, uses, and can radiate radio frequency energy, and if not installed and used in accordance with instructions may cause harmful interference to radio communications. Changes and modifications could void the user's authority to operate this equipment.

Toro conforms to the following US, Canadian and European Radio, Safety and EMC standards:

This equipment has been tested and passed on the following standards: EN 55022:2006 (amended by A1:2007), EN 300 330 V2.1.1:2017, EN 301 489-3 V2.1.1:2017, EN 302 291-2 V1.1.1:2005, CISPR 22:2005 (Amended by A1:2005 and A2:2006), RSS-Gen:2010, FCC 15.225:2011, ANSI C63.10:2009, EN 60950-1: 2006, IEC 60950-1: 2005 (2ND EDITION)

Radio Intentionally Emitting Radio Waves

- a) frequency band(s) in which the radio equipment operates: 13.56 MHz
- b) maximum radio-frequency power transmitted in the frequency band(s) in which the radio equipment operates: 11.2 dBuA/m

Printer or Battery Disposal/Recycle



Information for EU-member states only - The following symbol  of a crossed-out wheeled bin indicates that the Toro printer and battery must be disposed of properly and not treated as general waste. Incorrect disposal could have a negative impact on human health and the environment. For more information on the correct disposal/recycling of this printer or battery, please contact Graphic Products at 800.788.5572.



800.788.5572 | DuraLabel.com

©2011, 2018 Graphic Products, Inc. All Rights Reserved