

ADULT

Faith

A series by L. J. Harry



SERIES BIG IDEA

Faith is essential to salvation and is the cornerstone of a life that is pleasing to God.

Lesson 2.1

Lesson 2.2

Lesson 2.3

Lesson 2.4

You've Got Faith

Faith Saves

Faith Is

Faith Does



Faith:

You've Got Faith

A series by L. J. Harry

Lesson Big Idea: We are able to believe, not because of our own righteousness, but because God has gifted us with faith.

Foundation

Scripture Focus: Romans 12:3

Tell the story by L. J. Harry about seeing the president of the United States on page 44.

- » *Have you ever met a celebrity? If so, who and when? What did it feel like to meet someone famous?* ⚙️

Frame

A. The crowd awaited Jesus' return from the **mountain**.

1. The Father and His Possessed Son

- » *If you were this son's father or mother, how do you think you may have felt when you found out your son was demon possessed?* ⚙️
- » *To what lengths would you go to see him set free?* ⚙️

2. Jesus returned from the mountaintop.

3. The **disciples** were unable to cast out the demon.

- » *If you were the disciples, what might you be thinking after all your attempts to cast the spirit out were fruitless?* ⚙️
- » *If you were Jesus, what might you think of your disciples?* ⚙️
- » Mark 9:20

B. The Father's Doubt

1. There are moments when your faith is shaken and tested.
 - » Mark 9:23
2. The key to this miracle and others is just **simple faith**.
3. There will be times when we doubt.
 - » *If you did not already know the outcome of this story, how would you think Jesus would have responded?* ⚙️
 - » *If you were Jesus, how would you have responded?* ⚙️
 - » *Why is it easy to have great faith at times but little faith at others?* ⚙️
 - » *Do you find yourself living with great faith or little faith most of the time? Why?* ⚙️

Finish

Tell the end of the story when Jesus healed the demon-possessed boy on page 47-48.

Foundation

Scripture Focus: Romans 12:3 

L. J. Harry tells the following story:

I still remember the day I saw the president of the United States in person. It was the fall of 2004, and President George W. Bush was finishing up his crisscross campaign of the US one month before Election Day. On that particular Saturday evening, he was coming to my hometown of Orlando. I was beyond excited to see the president. My family had come down from Ohio to visit, and they were going to go with us to the rally.

When we made it to the stadium, we were surrounded by a sea of people. And amidst all the moms and dads with cameras and binoculars, and all the kids with Bush buttons and flags, I saw the Secret Service. They were checking bags and purses, and they were mixing in with the crowd, watching for anything and anyone suspicious. I expected to see black suits, white shirts, and black ties, but these agents were in khakis and blue blazers. But their watchful eyes and their coiled earpieces gave them away.

We made our way through the crowd and to our seats in the arena. It was the middle of the day as we sat in the arena waiting for the president. From our seats, we could see the tunnel where we believed he would enter. I kept a close eye on the tunnel and a close eye on the stage. Throughout the day, several dignitaries stepped to the microphone and delivered their speeches to rally the crowd.

At first, their speeches were stirring. But as the day wore on and we wore out, we were done with the speeches and ready to see the president. The sun was setting, and the night was settling in, but still no president. Then one more spokeswoman stepped up to the mic and announced the president was almost to the stadium.



The restless crowd started to get excited. Then I heard a helicopter. Could it be? Was President Bush going to land in the center of the stadium in Marine One? Was I going to see the president and Marine One on the same night? I kept watching and waiting for the helicopter to land, but it never seemed to get any closer to the ground.

Ahhh. Maybe it was security. Or maybe it was a diversion. These people are clever. From where I sat, I could see an exit ramp off the interstate. I could not decide if I should watch the helicopter or watch for the motorcade. While I was looking up and looking around, I heard these famous words echo throughout the stadium, "Ladies and gentlemen, the president of the United States."

I looked toward the tunnel, and there he was. The president was standing in the same stadium as me. I cannot describe how exciting it was to see and hear the president and first lady. It was worth the several hours of waiting, sitting in the steamy, hot weather on the rock hard bleachers.

 **Have you ever met a celebrity? If so, who and when? What did it feel like to meet someone famous?**

Frame

The crowd awaited Jesus' return from the mountain.   Rumor had it that Jesus was at the top. He could not stay there forever. And when He came back down the mountain, they would be ready. Someone in the crowd spotted a man near the middle.

"Is that Him?"

The crowd craned their necks and squinted to see who was coming toward them. As he got closer, the crowd sighed when they realized it was just a guy who had gone camping halfway up the mountain.

The Father and His Possessed Son

They sat. They stood. They waited. They wondered when He would come down. And that is when they heard the shriek. One of the young men ran for the water. His dad was chasing after him, but he was too fast for his father. He thrashed around in the water for a while. His dad tried his best to pull him away. He tried to coax him, convince him. The years had been hard on this family.

This son was only a few years old when this dad realized his son was not in control. The Scripture tells us the devil tried to destroy the son in water and in fire, but he could not. But that did not keep him from trying. And the horror of losing his son or losing his own mind is what brought this father to the mountain that day. He had heard of Jesus and heard what He could do. And he was going to ask Jesus for a miracle.

 **If you were this son’s father or mother, how do you think you may have felt when you found out your son was demon possessed?**

 **To what lengths would you go to see him set free?**

Jesus Returned From the Mountaintop

Finally, after several minutes that seemed like months, the crowd could see Jesus and three of His faithful few starting to leave the summit, heading down the mountain. This was everybody’s chance to be saved, healed, delivered, and forgiven. You name it, Jesus could do it. People brought their prayer request cards and wish lists, hoping Jesus would grant them.

As He made His way toward the crowd, the crowd made their way toward Jesus. They ran from all directions in His direction. But rather than worship, Jesus could hear arguing. He saw nine of His disciples and some of the religious teachers in a war of words, and Jesus asked why they were arguing.

The disciples were unable to cast out the demon.  

But before Jesus could get an answer, this forlorn father spoke up. “Master, my son is possessed by a spirit. It tears him. He foams at the mouth. He gnashes with his teeth. The spirit even tries to destroy him in water and in fire. I brought him to your disciples to cast him out, but they could not. I need You to help me.”



It must have been a difficult day when this dad found out his son was going to struggle. He watched as other dads sent their sons away for summer camps, but he could not afford to let his son out of his sight. He was not trying to keep him from having fun, he was just trying to keep him out of the water and out of the fire. He was trying to keep him alive. Life was unthinkable difficult for the dad. Life was unthinkable difficult for the boy.

 **If you were the disciples, what might you be thinking after all your attempts to cast the spirit out were fruitless?**

 **If you were Jesus, what might you think of your disciples?**

From this father’s point of view, the spirit that had attached itself to his son must have appeared indomitable. Mark 9:18 reads, “Whenever it seizes him, it throws him down” (ESV). The boy looked like a puppet, caught on the end of a string controlled by a merciless puppeteer. And the devil was pulling the strings whenever and however he wanted, as if this child was created as mere entertainment for a sick and sadistic devil.

LESSON BIG IDEA: We are able to believe, not because of our own righteousness, but because God has gifted us with faith.

Once the disciples tried to cast him out and could not, he must have appeared just as strong to them as he appeared to the father. This devil had not yet met Jesus, but he was about to. They brought the boy to Jesus, and as soon as he saw Jesus, the devil knew his seconds were numbered. That is when he revealed his grim colors. The Bible reads, “And when he saw him (Jesus), straightway the spirit tare him; and he fell on the ground, and wallowed foaming” (Mark 9:20, KJV).  

It does not take a degreed theologian to understand the devil cares not for our souls or for our safety. When he peddles his wares, he only peddles one product: sin. And sin, according to James 1:15, always brings forth death. He may sell sin in different shapes, colors, and sizes, but when you tear away all the trappings, all Satan has to sell is sin. And all sin has to offer is death.

Here is what intrigues me about the devil and this story. The devil could not destroy this boy. If he could have, he would have. All he could do was make life miserable for him, but he could not take his life. If the devil could destroy us, he would, but he cannot. But that is not for lack of trying. So he often resorts to his plan B. He tries to destroy our faith. He will try to shake us and test our faith to see if we truly believe what we say we believe. He does that to us, and he did that to this father in Mark 9.

The Father’s Doubt

This father’s faith had been so shaken, he was able to stand sandal to sandal and stare into the compassionate eyes of Almighty God—the Great I Am—and still doubt. The next statement this dad made was filled with as much doubt as faith. “If You can do anything, have compassion on us and help us.” Two letters which cast such a dark, foreboding shadow over faith—*if*.

Take a quick look at Jesus’ highlight reel so far. He has turned water into wine, healed a nobleman’s son, cast out a devil in Capernaum, healed Peter’s mother-in-law, brought in more fish than the fishermen could count, touched and healed a leper, cleansed nine lepers and made one absolutely whole, healed a man sick with palsy, healed a withered hand, raised a widow’s son from the dead, calmed a storm, cast out two devils in Gadara, healed a twelve-year-long issue of blood, and raised Jairus’ daughter from the dead. And those are just some of the highlights.



We know, the disciples knew, and Jesus knew He could do anything for anyone at any time. But this father did not know that. The difficulty this father faced was so formidable in his mind, it eclipsed even the brightness of the glory of God standing in front of him. It is easy to fault him, but it is even easier to imitate him. If your faith has not yet been tested, just wait, it will be.

When the phone rings and the doctor calls you into her office to break the news that the cancer has spread, when the boss calls you into his office to break the news that the company is closing the doors on your career and your retirement, or when the highway patrol appears at your doorstep early in the morning to tell you the children you love most were involved in a tragic accident and are fighting for their lives—those are **moments when your faith is shaken and tested**. When you walk out of the doctor’s office or the boss’ office or into the ICU, those are the times you identify most with this heartbroken, exhausted father. “God, if You can heal this cancer. If You can find me another job. If You can raise up my baby girl.”

This father’s prayer was filled with the very real, unvarnished pain that had dogged him for the last couple of decades. So he reached out to Jesus in one last grasp for help and asked Jesus to have compassion and help him and his son. Jesus’ response is remarkable. Jesus said, “If thou canst believe, all things are possible to him that believeth” (Mark 9:23, KJV). 

Other translations make it clear that Jesus was incredulous. “What do you mean, ‘If I can?’” (Mark 9:23, NLT). “‘If you can?’” (Mark 9:23, NIV). “‘If you can!’” (Mark 9:23, ESV). “‘Since You can,’ or ‘Because You can’ would have been a more appropriate prayer, but the beauty of the Bible is the real, unvarnished

cry of this father. The Bible does not paint him as filled with faith because God knows we will not always be filled with faith.

The key to this miracle and others is just simple faith.   If we can believe, all things are possible to him and her who believes. According to Romans 12:3, God has dealt to every one of us a measure of faith. This father was given a measure of faith near the beginning of his life, but when his son began to be tortured by the devil, his faith began to wane. And every time the devil threw his son into the water, his faith waned. And each time the devil threw his son into the fire, his faith waned. Like a nail in the tread of a tire, his faith waned until there was very little left to push him forward. But he had just enough faith to reach out to Jesus.

There will be times when we come home from camp meeting or a conference and our faith soars above the clouds. In those times, it is easy to believe God is able and willing to work every miracle we need from Him. We know He is able to cure every incurable disease, empty every hospital bed, close every funeral home, pay the bills, and bring the groceries. We know Him as the mighty God and the everlasting Father—the one able and the one willing to work miracles when we pray.

But there are times our faith crawls along the basement floor, and we want to believe He is able and willing to work the miracles we need from Him. In those times, camp meeting and those conferences seem but a distant, faint memory. And now we face a terminal diagnosis, a stack of bills, an empty pantry, and empty stomachs.

This miracle shines a bright, blinding light on a father's doubt. He was not filled with faith, but despite his doubt, Jesus still took the time to hear his prayer and feel his pain. The father then looked to Jesus and responded, "Lord, I believe; help my unbelief!" (Mark 9:24, NKJV). He made no excuse for his doubt nor tried to justify himself with "I didn't mean if You can help. I meant since You can help. Yeah, that's it." He just cried out, "I believe, but I need You to help my unbelief."

There will be times when we doubt. We need not make excuses for our doubt because God will see right through them. We just need to respond honestly, like this father responded, and ask God to help us believe.

 **If you did not already know the outcome of this story, how would you think Jesus would have responded?**

 **If you were Jesus, how would you have responded?**

 **Why is it easy to have great faith at times but little faith at others?**

 **Do you find yourself living with great faith or little faith most of the time? Why?**

Finish

As the Scripture zooms out, we see a crowd of people running toward Jesus, this father, and the boy. They were curious to see what Jesus would do, what He would say. Jesus' next action was filled with compassion and power. He rebuked the unclean spirit, saying to it, "Deaf and dumb spirit, I command you, come out of him and enter him no more!" (Mark 9:25, NKJV). Against his will, the unclean spirit knew he had to go, but before he left, Mark 9:26 reads, "the spirit shrieked, convulsed him violently" (NIV).

This action was one more indicator that the devil cares not for us. He left the boy like a vengeful tenant may leave an apartment. The King James Version reads "the spirit cried, and rent him sore." He punched holes in the drywall, broke the windows, ripped out the vanity, and left the water running in the tub. He did all he could to hurt the boy one more time, but he knew he had to go once Jesus spoke the word.

LESSON BIG IDEA: We are able to believe, not because of our own righteousness, but because God has gifted us with faith.

To everyone's amazement, the boy lay on the ground motionless, seemingly lifeless. Many of the people around thought he was dead. But Jesus calmly walked to where he was lying, took him by the hand, and lifted him up. And he arose. From there, the father and son were reunited, and both of their lives were changed. In fact, the son's life was spared.

The Bible is silent regarding whether the father gave thanks to Jesus or whether he quit his job and followed Jesus. The very next verse places Jesus inside a house with His disciples, but the father and his newly delivered son are not recorded. This miracle is special because it shows the undisguised doubt of a frustrated, fatigued dad. But it also shows the compassion and power of our compassionate and powerful heavenly Father.

Hopefully today, your faith is soaring. Hopefully you believe God is able and willing to do everything you need Him to do. But perhaps your faith is not soaring. It may not even be climbing or gliding. It might be crawling. But you still have faith, for we know we have all been given a measure of faith.

So follow in the footsteps of the father in this story. Make your way to Jesus, make your impassioned plea to Him, and then trust Him to do what He knows to do and what only He can do. You will find He has the compassion and the power to work a miracle on your behalf.

Small Group Leader's Guide

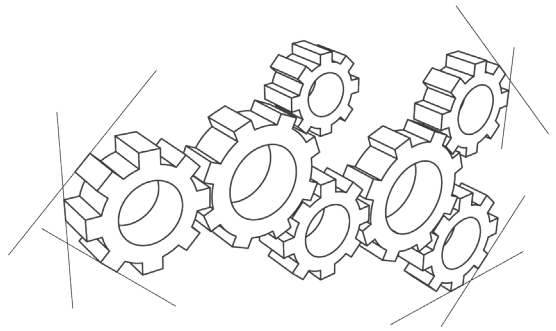

Faith: *You've Got Faith*

Opening Question: Who is one person from history you would really like to meet? Why?

Scripture Focus: Romans 12:3

Tell the story by L. J. Harry about seeing the president of the United States on page 44.

Group Discussion:

- Why is it easy to have great faith at times but little faith at others? ⚙️
- Do you find yourself living with great faith or little faith most of the time? Why?
- What are some prayers God has answered for you?
- Why is prayer a privilege?
- Why do many look at prayer as a chore instead of a privilege? ⚙️
- What are some traps the enemy sets for Christians?
- How do we avoid falling into these traps?
- What does it mean to have your faith tested and tried? ⚙️
- What is one of the biggest tests your faith has faced?
- How did God's strength help you through that testing?
- What is faith?
- What do you think it means to have a "measure of faith"? ⚙️
- Why do people struggle with doubt? ⚙️
- When have you personally struggled with doubt?
- How has God helped you during those times?

Prayer Focus

Lord, thank You for every answer to prayer I have received. Keep me from the traps the enemy sets for me. Strengthen my faith when it is tested and tried. Thank You for the faith You have given me. Be my help when I struggle with doubt.

YOUTH

Faith

A series by L. J. Harry



SERIES BIG IDEA

Faith is essential to salvation and is the cornerstone of a life that is pleasing to God.

Lesson 2.1

Lesson 2.2

Lesson 2.3

Lesson 2.4

You've Got Faith

Faith Saves

Faith Is

Faith Does

Faith

You've Got Faith

BLUEPRINT

SERIES BIG IDEA

Faith is essential to salvation and is the cornerstone of a life that is pleasing to God.

LESSON BIG IDEA

We are able to believe, not because of our own righteousness, but because God has gifted us with faith.

LEARNING TARGET

To realize that God gives us the right amount of faith for every situation.

KEY SCRIPTURE PASSAGE

Romans 12:3

SUPPLIES

blindfold, 2x4

FOUNDATION

L. J. Harry tells the following story:

I still remember the day I saw the president of the United States in person. It was the fall of 2004, and President George W. Bush was finishing up his crisscross campaign of the US one month before Election Day. On that particular Saturday evening, he was coming to my hometown of Orlando. I was beyond excited to see the president. My family had come down from Ohio to visit, and they were going to go with us to the rally.

When we made it to the stadium, we were surrounded by a sea of people. And amidst all the moms and dads with cameras and binoculars, and all the kids with Bush buttons and flags, I saw the Secret Service. They were checking bags and purses, and they were mixing in with the crowd, watching for anything and anyone suspicious. I expected to see black suits, white shirts, and black ties, but these agents were in khakis and blue blazers. But their watchful eyes and their coiled earpieces gave them away.

We made our way through the crowd and to our seats in the arena. It was the middle of the day as we sat in the arena waiting for the president. From our seats, we could see the tunnel where we believed he would enter. I kept a close eye on the tunnel and a close eye on the stage. Throughout the day, several dignitaries stepped to the microphone and delivered their speeches to rally the crowd.

At first their speeches were stirring. But as the day wore on and we wore out, we were done with the speeches and ready to see the president. The sun was setting and night was settling in, but still no president. Then one more spokeswoman stepped up to the mic and announced the president was almost to the stadium.

LESSON BIG IDEA: The Gift of Faith

The restless crowd started to get excited. Then I heard a helicopter. Could it be? Was President Bush going to land in the center of the stadium in Marine One? Was I going to see the president and Marine One on the same night? I kept watching and waiting for the helicopter to land, but it never seemed to get any closer to the ground.

Ahhh. Maybe it was security. Or maybe it was a diversion. These people are clever. From where I sat, I could see an exit ramp off the interstate. I could not decide if I should watch the helicopter or watch for the motorcade. While I was looking up and looking around, I heard these famous words echo throughout the stadium, “Ladies and gentlemen, the president of the United States.”

I looked toward the tunnel, and there he was. The leader of the free world—the most powerful man in the world—was standing in the same stadium as me. I cannot describe how exciting it was to see and hear the president and first lady. It was worth the several hours of waiting, sitting in the steamy, hot weather on the rock hard bleachers.

Opening Discussion:

- Have you ever met a celebrity? Who and when?
- What did it feel like to meet someone famous?

Middle-School Exercise:

1. You need a strong 2x4 or something similar that will not break when a young person stands on it.
2. Send all but two to four of the strongest students out of the room.
3. Have the strong students hold the ends of the 2x4 and hold it about 6 inches off the ground. Tell these students that when you ask them to raise the 2x4, they should gently shake the ends as if they are raising it, but not raise it any higher. Be sure they understand the goal is not to knock the student off the 2x4.
4. Have the students standing outside the room come in one at a time. Blindfold the student and help him or her step onto the 2x4. While on the 2x4, allow the student to hold onto your shoulder for balance. Now tell the student to jump off of the 2x4.
5. Next help the student step back onto the 2x4, holding onto your shoulder for balance. Tell the students holding the 2x4 to raise it up. The students on the ends of the 2x4 will gently shake the ends like they are raising it, without raising it any higher. While they do this, you bend your knees so the blindfolded student thinks the 2x4 is really being raised.
6. Now tell him or her to jump.
7. The main principle behind this is that our faith in God is not a blind faith.

Senior-High Exercise:

1. You need a strong 2x4 or something similar that will not break when a young person stands on it.
2. Send some of your students out of the room and fill in the rest on what you will be doing.
3. Have two to four of the strongest students hold the ends of the 2x4 and hold it about 6 inches off the ground. Tell these students that when you ask them to raise the 2x4, they should gently shake the ends as if they are raising it, but not raise it any higher. Be sure they understand the goal is not to knock the student off the 2x4.
4. Have the students standing outside the room come in one at a time. Blindfold the student and help him or her step onto the 2x4. While on the 2x4, allow the student to hold onto your shoulder for balance. Now tell the student to jump off of the 2x4.
5. Next help the student step back onto the 2x4, holding onto your shoulder for balance. Tell the students holding the 2x4 to raise it up. The students on the ends of the 2x4 will gently shake the ends like they are raising it, without raising it any higher. While they do this, you bend your knees so the blindfolded student thinks the 2x4 is really being raised.
6. Now tell him or her to jump.
7. The main principle behind this is that our faith in God is not a blind faith.

 Have one or two of your students share a faith story of their own. If you have no students willing to share an instance when they were able to demonstrate their faith, share one of your own.

FRAME

I. Faithless/Powerless

A. The crowd awaited Jesus' return from the **mountain**.

Rumor had it that Jesus was at the top. He could not stay there forever. And when He came back down the mountain, they would be ready. Someone in the crowd spotted a man near the middle. "Is that Him?"

The crowd craned their necks and squinted to see who was coming toward them. As he got closer, the crowd sighed when they realized it was just a guy who had gone camping halfway up the mountain.

B. The Father and His Possessed Son

They sat. They stood. They waited. They wondered when He would come down. And then they heard the shriek. One of the young men was running for the water. His dad was chasing after him, but he was too fast for his father. He thrashed around in the water for a while. His dad tried his best to pull him out. He tried to coax him, convince him. The years had been hard on this family.

This son was only a few years old when this dad realized his son was not in control. The Scripture tells us the devil tried to destroy him in water and in fire, but he could not. But that did not keep him from trying. And the horror of losing his son or losing his own mind is what brought this father to the mountain that day. He had heard of Jesus and had heard what He could do. And he was going to ask Jesus for a miracle.

C. Jesus returned from the mountaintop.

Finally, after several minutes that seemed like months, the crowd could see Jesus and three of His faithful few starting to leave the summit, heading down the mountain. This was everybody's chance to be saved, healed, delivered, and forgiven. You name it, Jesus could do it. People brought their prayer request cards and wish lists, hoping Jesus would grant them.

As He made His way toward the crowd, the crowd made their way toward Jesus. They came from all directions in His direction. But rather than worship, Jesus could hear arguing. He saw nine of His disciples and some of the religious teachers in a war of words, and Jesus asked why they were arguing.

D. The **disciples** were unable to cast out the demon.

But before Jesus could get an answer, this forlorn father spoke up. "Master, my son is possessed by a spirit. It tears him. He foams at the mouth. He gnashes with his teeth. The spirit even tries to destroy him in water and in fire. I brought him to your disciples to cast it out, but they could not. I need You to help me."

It must have been a difficult day when this dad found out his son was going to struggle. He watched as other dads sent their sons away for summer camps, but he could not afford to let his son out of his sight. He was not trying to keep him from having fun; he was just trying to keep him out of the water and out of the fire. He was trying to keep him alive. Life was unthinkable difficult for the dad. Life was unthinkable difficult for the boy.

LESSON BIG IDEA: The Gift of Faith

1. From this father's point of view, the spirit that had attached itself to his son must have appeared indomitable.
2. Mark 9:18 reads, "Whenever it seizes him, it throws him down" (ESV).
3. Once the disciples tried to cast the spirit out and could not, it must have appeared just as strong to them as it appeared to the father.
4. They brought the boy to Jesus, and as soon as the spirit saw Jesus, it knew its seconds were numbered. That is when it revealed its grim colors.
5. The Bible reads, "And when he saw Him (Jesus), immediately the spirit convulsed him, and he fell on the ground and wallowed, foaming at the mouth" (Mark 9:20, NKJV). 
6. It does not take a degreed theologian to understand the devil cares not for our souls or for our safety.
7. Here is what intrigues me about the devil and this story. The devil could not destroy this boy. If he could have, he would have. All he could do was make life miserable for him, but he could not take his life.
8. The devil will try to shake us and test our faith to see if we truly believe what we say we believe. He does that to us, and he did that to this father in Mark 9.

 *If you were one of the disciples, what might you be thinking after all your attempts to cast the spirit out did not work?*

 *If you were Jesus, what might you think of your disciples?*

II. Doubt vs. Simple Faith

A. The Father's Doubt

1. This father's faith had been so shaken, he was able to stand sandal to sandal and stare into the compassionate eyes of Almighty God—the Great I Am—and still doubt.
2. We know, the disciples knew, and Jesus knew He could do anything for anyone at any time. But this father did not know that.
3. If your faith has not yet been tested, just wait. It will be.

B. There are moments when our faith is **shaken** and **tested**.

1. When you walk out of the doctor's office or the boss' office and you've received bad news, those are the times you identify most with this heartbroken, exhausted father.
2. This father's prayer was filled with the very real, unvarnished pain that had dogged him for the last few years.
3. So he reached out to Jesus in one last grasp for help and asked Him to have compassion and help him and his son. Jesus' response is remarkable.
4. According to Mark 9:23, Jesus said, "If thou canst believe, all things are possible to him that believeth" (KJV). 

C. The key to this miracle and others is just **simple faith**.

1. This father was given a measure of faith near the beginning of his life, but when his son began to be tortured by the devil, his faith began to wane.
2. There will be times when we come home from camp meeting or a conference and our faith soars above the clouds. In those times, it is easy to believe God is able and willing to work every miracle we need from Him.
3. But there are times when our faith crawls along the basement floor, and we *want* to believe He is able and willing to work the miracles we need from Him.

4. This miracle of the father and his possessed son shines a bright, blinding light on a father's doubt. He was not filled with faith, but despite his doubt, Jesus still took the time to hear his prayer and feel his pain.
- D. There will be times when we doubt.
1. We do not need to make excuses for our doubt.
 2. We need to simply ask God honestly to help our belief.

 *If you did not already know the outcome of this story, how do you think Jesus would have responded?*

 *If you were Jesus, how would you have responded?*

 *This would be an excellent time for a personal testimony. Alternatively, consider asking ahead of time for a volunteer in the class to share his or her story.*

FINISH

As the Scripture zooms out, we see a crowd of people running toward Jesus, this father, and the boy. They were curious to see what Jesus would do and what He would say. Jesus' next action was filled with compassion and power. He rebuked the unclean spirit, saying to it, "Deaf and dumb spirit, I command you, come out of him and enter him no more!" (Mark 9:25, NKJV). Against its will, the unclean spirit knew it had to go, but before it left, Mark 9:26 reads, "the spirit shrieked, convulsed him violently" (NIV).

This action was one more indicator that the devil cares not for us. The King James Version reads "the spirit cried, and rent him sore." The spirit left the boy like a vengeful tenant may leave an apartment. It punched holes in the drywall, broke the windows, ripped out the vanity, and left the water running in the tub. The spirit did all it could to hurt the boy one more time, but it knew it had to go once Jesus spoke the word.

To everyone's amazement, the boy lay on the ground motionless, seemingly lifeless. Many of the people around thought he was dead. But Jesus calmly walked to where the boy was lying, took him by the hand, and lifted him up. And the boy arose. From there, the father and son were reunited, and both of their lives were changed. In fact, the son's life was spared.

The Bible is silent regarding whether the father gave thanks to Jesus or whether he quit his job and followed Jesus. The very next verse places Jesus inside a house with His disciples, but the father and his newly delivered son are not recorded. This miracle is special because it shows the undisguised doubt of a frustrated, fatigued dad. But it also shows the compassion and power of our compassionate and powerful heavenly Father.

Hopefully today your faith is soaring. Hopefully you believe God is able and willing to do everything you need Him to do. But perhaps your faith is not soaring. It may not even be climbing or gliding. It might be crawling. But you still have faith, for we know we have all been given a measure of faith.

So follow in the footsteps of the father in this story. Make your way to Jesus, make your impassioned plea to Him, and then trust Him to do what He knows to do and what only He can do. You will find He has the compassion and the power to work a miracle on your behalf.

Discussion Questions:

- When have you personally struggled with doubt?
- How has God helped you during those times?

LESSON BIG IDEA: The Gift of Faith

Middle-School Finish:

1. Discuss a situation in which you or one of your students had an opportunity to show your faith in God.
2. This could be a difficult life situation or an opportunity for evangelism.
3. What did you or the student choose?
4. Was it the right choice?
5. If not at first, did you or the student eventually choose to have faith in God?
6. How did God repay that faith?

Senior-High Finish:

1. As a class, think of some difficult situations in which a large amount of faith might be required.
2. Work through the scenarios with students.
3. What are the benefits of faith in each situation?
4. How can you demonstrate faith appropriately in each scenario?
5. Does a negative outcome mean you didn't have enough faith? (No! Absolutely not.)

The Big Picture:

- God has gifted us with a portion of faith.
- Even in times of uncertainty, that faith will be enough to sustain us.

Final Reflections

- If you were this son's father or mother, what do you think it may have felt like to find out your son was demon possessed?
- To what lengths would you go to see him set free?
- Why is it easy to have great faith at times but little faith at others?
- Do you find yourself living with great faith or little faith most of the time? Why?

 *Allow students time to share what they have written.*

SELAH

Using the following points, take this time to guide your students in prayer.

- Lord, thank You for every answer to prayer that I have received.
- Keep me from the traps the enemy sets for me.
- Strengthen my faith when it is tested and tried.
- Thank You for the faith You have given me.
- Be my help when I struggle with doubt.

 *Allow time for students to update their Personal Discipleship Guide.*

CHILDREN

Faith



SERIES BIG IDEA

Faith is essential to salvation and is the cornerstone of a life that is pleasing to God.

Lesson 2.1

Lesson 2.2

Lesson 2.3

Lesson 2.4

You've Got Faith

Faith Saves

Faith Is

Faith Does



Faith:

You've Got Faith

BLUEPRINT

SERIES BIG IDEA

Faith is essential to salvation and is the cornerstone of a life that is pleasing to God.

SERIES MEMORY PASSAGE

"But without faith it is impossible to please him: for he that cometh to God must believe that he is, and that he is a rewarder of them that diligently seek him" (Hebrews 11:6).

LESSON BIG IDEA

We are able to believe, not because of our own righteousness, but because God has gifted us with faith.

STUDENTS WILL investigate the definition of *faith*.

Early Elementary (Grades 1-3)

TOOL BOX

FOUNDATION

- PowerPoint 2.1
- *For each group of 4 students:* 2-inch laminated paper with tiny word "faith" on it, article containing word "faith," magnifying glass or microscope, dictionary
- *Series song:* "Faith Is"
- *Two-sided Visual:* Acorn to an Oak Tree (TRP)
- Time-lapse video showing an acorn becoming an oak tree
- Whiteboard, marker, and eraser

FRAME

- Series 2 memory verse poster (TRP)
- Acorn pattern (TRP) (1 per student), scissors, crayons
- Paper for students, crayons
- 2 copies of the Bible lesson script (TRP)
- *Visual:* Mustard Seed (TRP)
- Ruler, small cups of dry rice

FINISH

- Activity papers and pencils
- Fan, crepe paper streamers, tape

SELAH

- *Series song and lyrics:* "Faith Is"

Late Elementary (Grades 4-6)

TOOL BOX

FOUNDATION

- PowerPoint 2.1
- *For each group of 4 students:* 2-inch laminated paper with tiny word "faith" on it, article containing word "faith," magnifying glass or microscope, dictionary
- *Series song:* "Faith Is"
- *Video:* "Life in a Drop of Water"
- Whiteboard, marker, and eraser

FRAME

- Series 2 memory verse poster (TRP)
- Index cards (1 per student) and marker or print the memory verse words
- Pencils and paper (1 per student)
- Whiteboard, markers, and eraser
- 2 copies of the Bible lesson script (TRP)
- *Visual:* Mustard Seed (TRP)
- Ruler, small cups of dry rice

FINISH

- Activity papers and pencils
- Faith cards (from FRAME activity), hole punch, ribbons, crayons, pens, stickers

SELAH

- *Series song and lyrics:* "Faith Is"



Foundation

Early Elementary (1-3)

Searching for Faith

Prior to class, write or print the word "faith" very small on two-inch pieces of paper and laminate them with contact paper (one for each group of four students). Locate printed articles containing the word "faith" (one article for each group of four students).

As students enter class, play the new series song, "Faith Is" . Show the small papers containing the word "faith." Ask students to guess the word on the paper. Write student responses on the whiteboard.

Have the class form groups of scientists and assistants (four in each group). Give each group a magnifying glass, a dictionary, a small paper containing "faith," and an article about faith. Students inspect the paper and article to find faith. Have one student in each group look up *faith* in the dictionary and read the definition to the group.

Late Elementary (4-6)

Reflection

- **Why would a scientist need tools to inspect something small?**
- **How can your friends see your faith in action?**
- **How can God find faith in you?**

Faith is carried in our hearts. Jesus does not need any tools to find our faith because He gave it to us as a gift.

Today we will investigate the definition of faith and learn how a father received the gift of healing for his son after asking for help in overcoming doubt.

Acorn to an Oak

Show an acorn, a real one or the visual (TRP) . Then flip over the visual to show an oak tree.

Show a time-lapse video of a tiny acorn becoming a mighty oak tree.

Suggested link: "Acorn to Oak Tree Time-Lapse"

www.youtube.com/watch?v=4BtKAKP5xOk

Discuss how the oak tree changes. Compare it to how faith starts out small and grows.

Reflection

- **Does the acorn look anything like the oak tree it will become?**
- **How is the acorn like our faith?**
- **How do you know the acorn can and will become an oak tree?**
- **What can happen if we have faith in God?**

Life in a Drop of Water

Show images of microscopic organisms in water such as the first fifty seconds from the video, "Life in a Drop of Water." Suggested link:

www.youtube.com/watch?v=_cpBK2t0Yeo

Afterwards, let students brainstorm facts they learned from the video. List responses on the whiteboard.

Reflection

- **Even though the parts of a cell aren't visible to our naked eyes, are they still there? How do you know?**
- **How is faith like unseen cells?**
- **How can we believe in what we do not see?**
- **Why do you believe in God?**

Frame

Early Elementary (1-3)

Late Elementary (4-6)

Series Memory Passage

“But without faith it is impossible to please him: for he that cometh to God must believe that he is, and that he is a rewarder of them that diligently seek him” (Hebrews 11:6).

Memory Call-out

Display the memory verse (TRP) . Number the students as 1, 2, or 3. Call out a number: 1, 2, or 3. The students with the corresponding number will stand and say the verse. Call the numbers in any order and even twice in a row. Play for several minutes to ensure students are comfortable with the verse.

Independent Practice/Reflection

Give each student a copy of the acorn pattern (TRP) . Hand out scissors and crayons. Instruct students to cut out the acorns and then write the verse on their acorns and color them.

Erase the Verse

Display the memory verse (TRP) . Write out the verse on the whiteboard. Erase every other word. Ask volunteers to fill in the blanks. After quoting, volunteers start erasing one word at a time while quoting it after each erasure.

Drawing the Memory Verse

Hand out paper and crayons. Students copy the verse at the top of their papers and draw a picture of themselves seeking God at the bottom of the page.

Students share their drawings with a partner.

Reflection

- How do we make God happy?
- Why do we need faith?

Memory Circle

Prior to class, create “faith cards” by writing one word or phrase from Hebrews 11:6 on a large index card for every student, or print out the memory verse words .

Display the memory verse (TRP) . Students will stand in a circle in word order, display the words at chest level, and recite the verse together. Continue reciting as two cards at a time are hidden until the class can recite without prompts. Students can swap cards, change positions, and repeat the activity.

When you’ve played for several minutes, set aside the cards for the Finish portion of today’s lesson.

Memory Blanks

Display the memory verse (TRP) . Give each student paper and a pencil. Ask students to copy the verse on their papers but leave out five words, drawing blank lines in the spaces.

Students exchange papers with a friend. Challenge students to write the missing words without referring to the displayed verse.

When they have finished, have students read the verse together as a class.

Reflection

- Why is it important to memorize and share God’s Word?
- According to the memory verse, what do we have to do when we come to God? Why?
- How will memorizing God’s Word build your faith?

Bible Lesson: You’ve Got Faith (Mark 9:17-29)

- Have you ever planted a seed? If so, what was it and what happened?
- Did you have faith when you planted your seed? Why or why not? 

Designate actors to play the roles of Jesus and a father. Give them each a script (TRP) . You will be the narrator. Divide the remaining students, having one group pretend to be scribes and the other to be followers of Jesus.

Early Elementary (1-3)

NARRATOR: One day a multitude was with Jesus and His disciples. Scribes who hated Jesus and His followers were criticizing the disciples. The scribes felt like they were better than the disciples because on this day the disciples had a problem. Jesus asked the disciples what was going on. A man in the crowd explained the situation. He revealed that since birth his son had been very sick.

FATHER: My son is possessed of a dumb spirit that prevents him from speaking, yet makes him fall down, tear at his skin, and have violent convulsions! It causes him to fall into campfires, gnash his teeth, and foam at his mouth!

NARRATOR: The father told Jesus that he had asked the disciples to pray for his son's healing. Although he had seen others get healed when the disciples prayed, today they had been unable to cast out the demon. The father was afraid that he did not have enough faith. Jesus told the man the same thing He had taught His disciples.

JESUS: If you can believe, all things are possible to you.

FATHER: I want to believe, but I need You to help me to believe more! Help me get rid of my doubt!

NARRATOR: Jesus rebuked the evil spirit and commanded it to come out of the child and to never enter him again. The boy fell to the ground as if he were lifeless. Jesus took him by the hand and raised him up, totally healed. The witnesses, father, and disbelieving scribes were amazed.

The Bible does not tell us that Jesus increased the father's faith. Jesus did not ask him, "How much faith do you have?" The man said he believed. Because of this little bit of faith, he made the effort to get his child to the disciples for healing. His effort qualifies as a good work, doesn't it? Imagine trying to get a falling down, thrashing child through a multitude. It probably made him very tired and he may have been embarrassed.

Just as the father was focused on his small portion of faith, thinking it was not enough, the disciples were focused on their imagined problem instead of the purpose. Privately they asked Jesus why

Late Elementary (4-6)

they had been unable to cast out the demon. They thought the problem was within them.

But who was delivering these miracles of healing? God! And who were the disciples supposed to have faith in? God, not themselves!

Jesus taught His disciples that nothing was impossible if they had faith as small as a mustard seed. He told a parable about faith the size of a mustard seed being able to move mountains. The disciples learned to depend on God, not themselves!

Show the mustard seed visual (TRP) . A mustard seed is about one-sixteenth of an inch long. Look how tiny one-sixteenth is on this ruler.

(Pass out the rice.) One grain of rice can hold four mustard seeds. Everyone take one grain of rice and find a place to keep it. Do you think you could carry it every day in your pocket without losing it? Or in your school backpack? We carry our faith in our hearts where we cannot forget it, lose it, or allow someone to steal it. Faith cannot be measured by a ruler. When you picked up that grain of rice, you were picking up four times as much faith as Jesus told the disciples they needed when believing for miracles.

Although mustard seeds start out tiny, some grow into a bush up to eight feet tall, almost a tree. Jesus wanted to show His disciples that a little faith could have incredible results, so He allowed the crowd to hear the man crying that he needed more faith. Only then did God give him his heart's desire—a healed child. Jesus proved that miracles come from believing and having the faith to receive them, not because of a measurable amount of faith, and not because of personal works.

Faith brings many changes in our lives. Faith comes by hearing, and hearing by the Word of God. You have the gift of faith, and you can receive the gift of the Holy Ghost.

Discussion Questions:

- **How do you think God feels when you doubt Him or His promises?**
- **How did the miraculous power of Jesus affect the faith of witnesses around Him?**
- ☆ **Define faith. Justify your answer with examples from the text.**
- ☆ **What will it take to help you build your faith?**

Finish

Early Elementary (1-3)

Late Elementary (4-6)

Family Connection

Review the instructions on the back of the activity paper. Give students a chance to discuss how they will carry out this assignment. If your class has consistent attendance, consider offering a reward for those who return the Family Connection, and provide time in the class to discuss the activity.

Activity Paper: *Have Faith*

Ask students to find the objects in the picture.

Fanning Faith

Prior to class, tape crepe paper streamers to a fan. Ask the following questions before turning on the fan.

- **What do you think will happen when I turn on the fan?**
- **How do you know the air will move the streamers?**
- **How do we know air is there even though we can't see it?**
- **How do we know God is here even though we can't see Him?**

Activity Paper: *Faith Pleases God*

Ask students to complete the word search. Then they should fill in the blanks to complete Hebrews 11:6 at the bottom of the page.

Faith Cards

Distribute the faith cards used in the Frame portion of the lesson. Fold them to resemble a greeting card. Hole punch the top folded corner. Have classmates sign each other's cards. Students may decorate cards, tie on hanging ribbons, and take them home.

- **What will you remember about this lesson when you look at your card and why?**
- **How do you please Jesus when you exercise your faith, and how does He reward you?**

Selah



Prayer

Dear God, we come before Your throne in faith, believing. Please help our unbelief today. Help us with our doubts, worries, and fears. Please give us courage to believe Your Word. In Jesus' name, amen.

Reflection

- **Why should we have faith when we pray?**
- **Do you think God answers prayers prayed in faith? Why or why not?**

Worship

Play the series song, "Faith Is" , and give students a copy of the lyrics .

Reflection

Help students pray for God to increase their faith.

Discuss how God can help them to have more faith.

Worship

Show the video, "I Believe," by Wes King and let students sing along. Suggested link:

www.youtube.com/watch?v=tq84Gr4FU_0

Reflection

Follow the song with prayer. Invite a student to start the prayer, and suggest giving thanks for the gift of faith. Ask another student to continue praying and to ask for help with recognizing and using all their faith.