

CHILDREN

The Living Word



SERIES BIG IDEA

Because God's Word gives life, we can receive the strength, hope, and direction it gives.

Lesson 2.1

Lesson 2.2

Lesson 2.3

Lesson 2.4

Forever Settled

Not by Bread Alone

The Inconvenient Truth

Words of Eternal Life



The Living Word: Forever Settled

BLUEPRINT

SERIES BIG IDEA

Because God's Word is alive, we should depend on the strength, hope, and direction it gives.

SERIES MEMORY PASSAGE

John 6:63

LESSON BIG IDEA

God's Word endures forever.

BIBLICAL PASSAGE

Romans 4:16-18

STUDENTS WILL explain God's Word endures forever because He keeps His promises.

Early Elementary (Grades 1-3)

TOOL BOX

FOUNDATION

- PowerPoint 2.1
- Circular objects: lids, rings, donuts, cookies, etc.
- Bible

FRAME

- Series 2 memory verse poster (TRP)
- Timer or stopwatch
- Frisbee
- Sticky notes (1 per student), and pencils
- Visual: Map of Abraham's Travels (TRP)
- Robe for Abraham
- Props: rolling upright suitcase, loaf of bread, water bottle, and pillow
- Abraham monologue (TRP)

FINISH

- Activity Papers and colored pencils
- Envelopes (1 per student) and art supplies
- Index cards (5 per student)

SELAH

- Series song and lyrics: "The Living Word"

Late Elementary (Grades 4-6)

TOOL BOX

FOUNDATION

- PowerPoint 2.1
- Circular objects: lids, rings, donuts, cookies, etc.
- Chairs

FRAME

- Series 2 memory verse poster (TRP)
- Whiteboard and marker
- Paper and pencils for students
- Bibles
- Visual: Map of Abraham's Travels (TRP)
- Robe for Abraham
- Props: rolling upright suitcase, loaf of bread, water bottle, and pillow
- Abraham monologue (TRP)

FINISH

- Activity Papers and colored pencils
- Promise charts (TRP) (1 per student)

SELAH

- Series song and lyrics: "The Living Word"

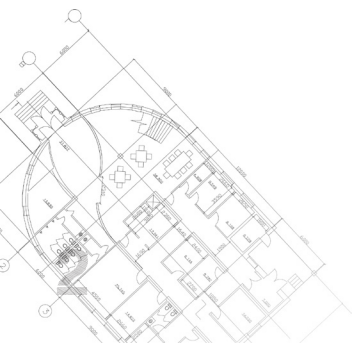

Foundation

Early Elementary (1-3)

Late Elementary (4-6)

Neverending Circles

Have multiple circle-shaped items available: lids, rings, donuts, or cookies. Ask students to find the beginning and end of each circle. They will all choose different points. Then, you can point out that there is no beginning or ending to a circle, it just keeps going and going.

God's Word is like this. Psalm 119:89 tells us, "For ever, O LORD, thy word is settled in heaven." There is no end to God's Word; it will last for all eternity.

Circle Squeeze

Join students to form a circle by holding hands. Begin by squeezing the hand of the student on your left. Have that student pass the "squeeze" to the person on her left and continue around the circle until everyone's hand has been squeezed.

Now have students repeat the activity, passing the "squeeze" around the circle several times, ending with different students each time or going the other direction.

Open the Bible to the very last verse, Revelation 22:21. Show the verse to students.

God's Word is forever. Just as our circle kept going, God's Word never ends. Revelation may be the last book of the Bible, but God's Word will last forever.

Reflection

- **What does God's Word say about our future?**
- **Do you think God will keep His promises? Why or why not?**

Student Circle

Send one student out of the room. Have the remaining students form a circle or put chairs into a circle.

Call the student back into the room and have the student find where the ending point of the circle is. The student will probably guess every student or chair in the room.

After a few guesses, point out that there is no end point. Even if someone is the last person to join the circle or if a certain chair is the last one to be placed in the circle, it does not make it the ending. In the same way, the last verse written in the Bible does not mean that's the end of the Word of God.

Reflection

- **What does it mean to be "forever settled in heaven"?**
- **How can you be sure God keeps His promises?**
- **Why do we know God's Word is forever?**

Frame

Early Elementary (1-3)

Late Elementary (4-6)

Memory Verse: *John 6:63* (TRP)

"It is the spirit that quickeneth; the flesh profiteth nothing: the words that I speak unto you, they are spirit, and they are life."

Quick Verse

Recite the verse several times while showing the memory verse (TRP) . Use a timer or stopwatch to see who can say the verse the fastest. Have students come forward, one at a time, to read the verse.

Explain that *quickeneth* means "to give life to something."

- **What do the words Jesus speaks give?**
- **Why do you think Jesus' words are life-giving words?**

Pass the Circle

Form students into a circle. Give a Frisbee to one student. Instruct students to pass the Frisbee to the left. During the game, if you say "switch," students must change the direction they are passing.

Play the series song, "The Living Word" . When the music stops, the person holding the Frisbee should stand and say the memory verse.

- **How did it feel when we changed directions?**
- **How does it feel to know God's Word never changes?**

Biblical Passage: *Romans 4:16-18*

Read the passage to your students. Give each student a sticky note and a pencil. Have students draw or write something they promise to do for God or their families.

- **What is a promise?** 
- **Do you keep your promises? Why or why not?**

Promise Discussion

Students find a partner. Allow them to discuss promises they have made to others or promises others have made to them.

Ask for volunteers to share their responses with the class.

Memory Verse Sparkle

Recite the verse several times while showing the memory verse (TRP) . Have students stand in a circle. The first person says the first word of the verse, the second person says the second word, and so on. When the last word has been said, the next person in line says, "Sparkle," and then the next person is out.

Start the verse over with the next person and keep going until everyone is out. Students are also out if they say the wrong word when it is their turn.

- **What does it mean when the verse says "the spirit that quickeneth" and "the flesh profiteth nothing"?**
- **Investigate the verses prior to John 6:63. What was Jesus referring to when He said, "the words that I speak unto you"?**

Roll a Verse

Gather students around a table. Take turns rolling a numbered cube (1-6). The number rolled is how many words of the verse the student will say before passing the cube. The next student picks up where the last student left off. Keep rolling and passing until everyone has a chance to say part of the verse.

- **How does it feel to know God keeps His Word?**
- **Why can we depend on God to keep His promises?**

Biblical Passage: *Romans 4:16-18*

Read the passage to your students. Write the word PROMISE on the whiteboard in large letters.

- **What is a promise?** 
- Hand out paper and pencils. Tell students to make a list of the promises God made in the Bible. Time permitting, find Scripture references that show that God kept His promises.
- Have students share their findings with the class.

Promise Discussion

Divide students into small groups. Have them discuss promises they themselves have made to God.

- **Have you kept your promises or not? Was it easy or difficult?**
- **What challenges make it difficult to fulfill those promises?**

Early Elementary (1-3)

Bible Lesson: Genesis 17

Today's lesson is a dramatic monologue (TRP)  told by Abraham. Dress Abraham in a robe and give him a rolling upright suitcase that contains a loaf of bread, a bottle of water, and a pillow. Students follow the actor as he walks and tells about God's promise to him. If possible, take students outside for the lesson.

- **Have you or your family ever moved to a different city or home? If so, what are some of the challenges of moving?**

Show the title slide . Abraham enters with suitcase.

Hello everyone, my name is Abraham. I am your guide for today's journey. I would like everyone to stand and follow me as I tell you about my life. *(Walk out of the classroom a few paces, stop, and begin monologue. Abraham should use the map (TRP) as he talks about his travels.)*

I brought my suitcase for our journey today. In my day we didn't have suitcases; we had donkeys to carry our belongings. I didn't think the pastor would approve of a donkey coming to class, so I brought a suitcase.

My adventure began one day when I heard God speak to me. This was unusual because the only gods I knew, like the ones my father had made, never spoke. God told me, "Get away from this country and all your kinfolk and your father's house and go to a special land that I have for you." I had to leave my relatives, including my dad's family.

It was a hard thing to do, but I wanted to obey God and follow His instructions. My father was an idol maker, but I believed in the one, true God. Every day my dad hammered away, making idols of gold and silver. The idol images formed with hot metal and human hands meant nothing to me. I didn't want to give praise to the moon god. I wanted to worship the God who created the moon. The idols were everywhere in our home and around the town. My friends probably thought I was crazy, because I didn't worship idols like them.

After hearing God's voice, I had no idea what God had planned for me. I just trusted Him and believed the promise He had given me when He spoke. *(Class quietly follows Abraham to another area of the church or outdoors. Stop and continue monologue.)*

God promised He would use me to make a great nation. He promised to bless me and make my name great. He told me I would be a blessing. He said, "I will bless them that bless thee and curse them that curse thee, and all the families on earth will be blessed through you." Even though this was a

Late Elementary (4-6)

mystery to me, I decided to follow God. *(Walk a little farther and continue monologue.)*

So at the ripe old age of seventy-five, an age older than some of your grandparents, I decided to obey God's Word. I packed up my belongings. *(Open the suitcase and share samples of the bread. Take water from the bottle and gently sprinkle students, telling them they may get hot on the journey. Fluff the pillow, close the suitcase, and continue.)* My wife, Sarai, my nephew, Lot, all those who had become a part of my household in Haran, and all of my livestock went with me. Imagine what it was like when we left Haran and began traveling to Canaan. All the camels, sheep, goats, cows, and people were following me across desert sands, rocky paths, and through muddy marshes. The dry climate made traveling easy in the summer, but extremely cold in the winter. After trekking for miles, we finally arrived in Canaan. We set up camp by Moreh. *(Students sit on the floor or ground.)*

God spoke to me again at Moreh as I viewed the wide open spaces before me. He told me that He would give this land to my seed! I was excited about that promise because Sarai and I didn't have any children and we were getting kind of old—older than your grandparents! God told me I would have as many children as the stars in the heavens and as the sand of the sea. I built an altar to the Lord there. *(Abraham builds an altar, then pauses, asking students to worship the Lord with him.)*

After stopping in Moreh, I moved my camp to Bethel and built another altar to the Lord and called upon His name. Then I continued on my way to the south. I trusted in God's promise, even though it wasn't easy. It was taking a long time for Him to fulfill His promise to me, but I knew if He had promised it, it was sure to happen because His promises are steadfast. Every promise God made to me came true. I eventually had a son named Isaac, even though I was very old. God gave me lands and made me the father of many nations. God always keeps His Word. *(Students follow you back to class.)*

Discussion Questions:

- **How would you respond if God asked you to leave your relatives and go to a place you did not know?**
- **Why did Abraham build altars along the way?**
- **What was God's promise to Abraham?**
- ☆ **How does God speak to us today?**
- ☆ **How do you respond when God speaks to you?**
- ☆ **Explain why we can trust in God's promises.**

Finish

Early Elementary (1-3)

Activity Paper: *God Keeps His Promises*

With colored pencils, ask students to color the stars and count the number of stars.

Late Elementary (4-6)

Activity Paper: *Abraham and Sarah's Promise Journey Map*

Help students to fill in the missing cities on the map. After coloring the map with colored pencils, they should trace the route Abraham took from Ur.

Family Connection

Review the instructions on page two of the Activity Paper and give students a chance to discuss how they will carry out this assignment. If your class has consistent attendance, consider offering a reward for those who return the Family Connection, and provide time in the class to discuss the activity.

Promise Envelope

Give each student an envelope and art supplies to design a promise envelope. Have students write the word PROMISE on the outside of their envelopes. Give each student five index cards. Tell students to draw or write ways God has been faithful to them. Encourage them to think of how God keeps His Word.

Promise Chart

Give each student a promise chart (TRP) . The top portion of this chart is for promises students have made to God. The bottom portion is for promises God has made to them.



Have students write promises on the left side. On the right side, they can write the date the promise was fulfilled, if it has been fulfilled at this time, and write what happened. For promises they made to God, they can write what they are doing in order to fulfill the promise.

Selah

Prayer

Dear Jesus, we thank You for Your Word. It is forever settled in Heaven. We thank You for Your promises. Help us to keep our promises to You, Lord, and to others. Help us to remember Your Word endures forever, because You keep Your promises. In Jesus' name, amen.

Praise and Worship

Provide lyrics (TRP)  and let students sing along with the series song, "The Living Word" . Follow up with prayer while the music plays.

Reflection

Challenge students to think of promises God has given them through His Word and through what He has spoken to them in prayer in the past. Have students thank God for those promises and claim them in Jesus' name as they pray.

Pray over the Word

Challenge students to think of God's promises written in His Word. Have students read Proverbs 30:5 : "Every word of God is pure: he is a shield unto them that put their trust in him."

Reflection

- **What does this verse tell us about the Word of God?**
- **What happens if we put our trust in God?**

Encourage students to take time to thank God for His Word, His faithfulness, and His protection.



YOUTH

The Living Word

A series by Daniel Koren



SERIES BIG IDEA

Because God's Word gives life, we can receive the strength, hope, and direction it gives.

Lesson 2.1

Lesson 2.2

Lesson 2.3

Lesson 2.4

Forever Settled

Not by Bread Alone

The Inconvenient Truth

Words of Eternal Life

The Living Word

Forever Settled

BLUEPRINT

SERIES BIG IDEA

Because God's Word gives life, we can receive the strength, hope, and direction it gives.

LESSON BIG IDEA

Because God's Word is eternal we can depend upon its promises.

LEARNING TARGET

To understand that when God says something, it is guaranteed to happen.

KEY SCRIPTURE PASSAGE

Psalm 119:89

SUPPLIES

note cards, whiteboard/bulletin board

FOUNDATION

Pounding in the "Real Estate For Sale" sign put a sound of finality to his decision. The homeowner looked up at the place he was leaving. He sighed as he took in the beauty of his home one last time, part of the most advanced civilization of its time. The brilliant white home shone in the reflection of the sun. His wife would be leaving behind indoor plumbing and an indoor cook stove. Ur's fresh market of any food imaginable would become a faint memory when they faced the rigors of desert life. The gold, the colored pens, the advanced schools, and much more would all be fading memories as they headed west.

Why were Abram and Sarai leaving their homeland? Because God said to. (See Genesis 12:1-2.) And Abram lived by every one of God's words. Abram and Sarai chose to leave the comforts of advanced Ur to live in tents. Instead of running water, they would have to run for water. Instead of indoor cooking, their food would be cooked in the mercy of the great outdoors. Instead of safe, clean walls, their new home would be held together by poles, ropes, and stakes.

Though he could not explain to his wife exactly where they were going, Abram went forward simply on what God had said. That does not seem like much to go on. Similarly, you cannot show your friends or family members exactly where you are headed. You take by faith the "Land of Promise" with Jesus for eternity. Such hope might seem as unstable as a tent, but when God speaks, His Word is more stable than that home left behind in Ur.

Opening Discussion:

- Has God asked you to do something difficult recently?
- Was it easy to obey, or are you still struggling to make that decision? Why?

LESSON BIG IDEA: Depending on God's Promises

Middle-School Exercise:

1. Using the core points section from the previous series, create a game of Bible jeopardy.
2. Write the questions on the notecards and arrange them by point values.
3. Add some general Bible questions to fill out a 5 by 5 board of questions.
4. This will help to review the last series and get the students' minds active for the coming lesson.



Senior-High Exercise:

1. Using the core points section from the previous series, create a game of Bible jeopardy.
2. Write the questions on the notecards and arrange them by point values.
3. Add some general Bible questions to fill out a 5 by 5 board of questions.
4. This will help to review the last series and get the students' minds active for the coming lesson.
5. Divide the class into a couple teams to make it more fun and competitive.

✳ *Have one or two of your students share a time in their lives in which God unexpectedly and miraculously came through. You want to highlight and enforce that the promises of God are true and can be trusted. Additionally, prepare a story of your own in which God fulfilled a promise to you. You may consider also bringing someone in for a testimony.*



FRAME



I. Everyone Needs a Starting Point

- A. One reason many people do not trust the Bible is because liberal scholars have said we do not know for sure even if we have the Word of God.
 1. Scholars who did not base their lives on Scripture have presented all kinds of objections to solid faith in a solid Bible.
 2. They make the Bible out to be a man-made book of wise teachings but nothing more.
- B. Every generation has seen an attack on the **written** Word of God.  
 1. Still, it is one of the oldest books and has evidence to prove its authenticity.
 2. Thousands of manuscripts exist to confirm that the Bible we use today is the same Word of God the first believers held in their hands.

II. Clarity of the Word







- A. God's word was clear when He called Abram out of Ur.
 1. See Acts 7:2-4. 
 2. This once-great city, located in modern day Iraq, housed much gold, troughs for channeling water indoors, kitchen stoves with chimneys, and "pens" with colored ink. Local schools appear to have taught math, astronomy, and medicine.
 3. There seems to have been no reason for Abram to leave such a sophisticated society, other than trusting what God said.

- B. God calls us all to leave something behind.
 1. The disciples left behind their businesses. Some today have left behind their own country to travel to a different land and share the gospel.
 2. All, however, must leave behind the old life which was governed by principles of selfishness and sinfulness.
 3. No doubt Abram was shocked at this part of the promise. How could he start a nation? He did not even have his own child!
- C. God's Word does not just give us **guidelines**; it gives us **hope** for the future.  
 1. God had plans for Abram to have thousands of descendants, yet the man was seventy-five and his wife was sixty-five.
 2. It was impossible for them to have children. This is why we must take God's Word by faith because He promises the impossible.

-  *What is something you have felt to leave behind as you have grown in your walk with the Lord?*
-  *Why is sharing our hope with others so important?*





 *This would be an excellent time for a personal testimony. Alternatively, consider asking ahead of time for a volunteer in the class to share his or her story.*

III. The Truth of the Word

- A. The Word of God leads you to **believe** and **expect** things that logic, emotion, or experience could never inspire.  
 1. Logic will not cause a person to think he will live forever in an immortal body.
 2. Experience will not lead anyone to believe that Jesus has prepared for them a place that is out-of-this-world. Only the promises of Scripture give hope beyond this life.
- B. Abram accepted God's word so completely that he started telling everyone he met.
 1. God later told him that he would be the father of a multitude. To reflect that destiny, God changed Abram's name to Abraham, meaning "father of a multitude." (See Genesis 17:5.) 
 2. We must share the hope we have with everyone. Do not hide your identity as an Apostolic Christian. Tell them of the one true God you serve and the hope you have in Him.
- C. He chose to see himself the way God saw him, rather than the way the facts appeared.
 1. A doctor might look at the situation and say, "I'm sorry, but you cannot have children." Abraham, however, looked at God's prognosis and said, "I'm going to be a daddy!"
 2. Because Abraham took active faith in God's word, the Lord accounted it to him for righteousness. (See Genesis 15:6.) 
- D. Our active faith today must not only **accept** the history of Jesus Christ but **believe** that His death, burial, and resurrection apply to our lives.  
 1. You, like Abraham, must actively believe that Jesus' righteousness is applied to you.
 2. You leave your comfort zone by turning from the old ways of life and confessing your sins.
 3. You rise to newness of life with Him as He fills you with His Spirit.
- E. Abraham had questions and may have faltered a few times, but he learned to hold onto God's word.
 1. You, too, will have to make the daily decision to live by faith in God's Word.
 2. By faith, you see yourself the way God sees you. You could live your life according to the way others see you, but if you do, you will go back to the old nature of sin you once lived in.
 3. When you take by faith God's view of you, you will live in keeping with that ideal. (See Romans 6:11-13.) 

LESSON BIG IDEA: Depending on God's Promises

IV. The Promises of the Word

- A. Even when it looks like a situation is hopeless, we can stand on the **promises** of God's Word.  
1. He will never leave you or forsake you, even if you feel alone.
 2. He will come back and bring you home to be with Him, even if life looks meaningless with no end in sight.
 3. He conquered sin and temptation, even if you feel like you will never win your struggle.
 4. Children of God must see themselves through His eyes. We must accept as reality what He has promised, not what we have experienced.
- B. Abraham was considered righteous because he was willing to stake every **thought, word,** and **action** on God's word.  
1. Twenty-five years after the promise, God gave him the promised child—Isaac.
 2. Two thousand years after the promise, the Promised Seed came—Jesus Christ.
 3. Abraham believed God's word about the Promised Seed in whom all nations of the earth would be blessed.

FINISH

Amy Carmichael responded to the prodding of the Lord to go to India. A local person asked, "Why are you here?" She did not have a clear answer, but she knew she was doing what God had called her to do.

"A life-changing experience took place in 1901. A little five-year-old girl, named Pearl Eyes, was brought to her by an Indian woman. The child had been sold by the mother to the temple, and there she was being prepared and taught all the degradation of temple prostitution. Twice she had run away only to be caught, carried back, beaten, and subjected to the terrible perversion of that Hindu temple. Finally, as she was running away again at night, she met with this understanding woman who brought her to Amy, who gathered the child up into her lap and picked up the rag doll and gave it to the child to play with. It was then that she really understood the evil of the temple practice. Little Pearl Eyes talked freely as she played with the doll. She told Amy things that they did to her in the temple, demonstrating them using the doll. The date was March 7, 1901. Amy never forgot that day nor the child's story. It was terrible beyond imagination. This was the beginning of her rescue of these children who had been dedicated to the temple gods."

She rescued one and then another. Many years later, she had rescued hundreds of girls from slave prostitution.

(Excerpts taken from gfamissions.org/missionary-biographies/carmichael-amy-1867-1951.html, accessed October 13, 2015.)

Believers must build every aspect of their lives on every principle of God's Word. Is your home-life built on God's blueprint in His Word? A selfish generation looks to God for happiness. They want miracles without commitment. Abraham did not just believe what God said about God; he believed what God said about Abraham. What is God's Word saying about you?

Discussion Questions:

- Reflect on your life for a moment. Do many of your choices and actions reflect popular culture, or are they undeniably built directly on the Word of God?
- Do you value your Bible as dearly as people do in countries where Christianity is outlawed? Why or why not?

Middle-School Finish:

1. Discuss prayer to God.
2. What are we asking Him for? Are our requests things that we want or things that we need?
3. Do you also thank God when you pray and worship Him or is it purely for our own reasons that we talk to Him. (By identifying how students are praying, we can effectively improve a student's prayer life.)

Senior-High Finish:

1. Discuss prayer with your students. Determine how they are praying, whether it be in the format of the Lord's prayer or another way.
2. What are you praying for?
3. Are you thanking God and praising Him in the course of prayer or simply asking for your own needs?
4. How can we simplify our prayer life by also deepening it in relationship with Jesus?
5. Do we talk to Him like some foreign unknown God or do we talk to Him like a friend?

The Big Picture:

- When God makes promises, we can fully believe on them.
- His Word confirms that whatever He says is what shall happen.

Final Reflections

- Have you experienced moments of doubt in God's Word?
- How have you overcome those moments of doubt?
- Why is sharing our hope with others so important?
- Do you worry much about what other people think of you? Why or why not?

 *Allow students time to share what they have written.*

SELAH

Using the following points, take this time to guide your students in prayer.

- Jesus, thank You for the solid foundation You have given me.
- You are dependable and never changing and I need Your Word to survive.
- Show me the truth of it and reveal to me Your will through Your scriptures.
- Even though I cannot see what You are doing in my life, I thank You and love You for the work You are doing in me, just as the Word confirms.

 *Allow time for students to update their Personal Discipleship Guide.*

ADULT

The Living Word

A series by Daniel Koren



SERIES BIG IDEA

Because God's Word gives life, we can receive the strength, hope, and direction it gives.

Lesson 2.1

Lesson 2.2

Lesson 2.3

Lesson 2.4

Forever Settled

Not by Bread Alone

The Inconvenient Truth

Words of Eternal Life



The Living Word:

Forever Settled

A series by Daniel Koren

Lesson Big Idea: Because God's Word gives life, we can receive the strength, hope, and direction it gives.

Foundation

Scripture Focus: Psalm 119:89

Tell the story of Abram and Sarai leaving Ur on page 44.

Frame

A. Everyone needs a starting point for life.

» Psalm 119:89

1. One reason many people do not trust the Bible is because liberal scholars have said we do not know for sure if we even have the Word of God.

» *Have you experienced moments of doubt in God's Word?* ⚙️

» *How have you overcome those moments of doubt?* ⚙️

2. Every generation has seen an attack on the **written** Word of God.

B. God's word was clear when He called Abram out of Ur.

» Acts 7:2-4

1. God calls us all to leave something behind.

» *What is something you have felt to leave behind as you have grown in your walk with the Lord?* ⚙️

2. God's Word does not just give us **guidelines**; it gives us **hope** for the future.

C. The Word of God leads you to **believe** and **expect** things that logic, emotion, or experience could never inspire.

1. Abram accepted God's word so completely that he started telling everyone he met.

» Genesis 17:5

» *Why is sharing our hope with others so important?* ⚙️

2. He chose to see himself the way God saw him, rather than the way the facts appeared.

» Genesis 15:6

3. Our active faith today must not only **accept** the history of Jesus Christ but **believe** that His death, burial, and resurrection apply to our lives.

4. Abraham had questions and may have faltered a few times, but he learned to hold onto God's word.

» II Corinthians 5:21

» Romans 6:11-13

» *Do you worry much about what other people think of you? Why or why not?* ⚙️

» Romans 4:16-19

D. Even when it looks like a situation is hopeless, we can stand on the **promises** of God's Word.

- » I Corinthians 1:21
 - » *What are some promises from God's Word you have stood upon?* ⚙️
 - » Romans 4:20-21
1. Abraham was considered righteous because he was willing to stake every **thought**, **word**, and **action** on God's word.
 - » Romans 4:22
 - » Romans 4:23-25
 2. Abraham believed God's word about the Promised Seed in whom all nations of the earth would be blessed.
 - » Galatians 3:16
 - » Romans 6:11

Finish

Tell the story of Amy Carmichael on page 47.

- » *Reflect on your life for a moment. Do many of your choices and actions reflect popular culture, or are they undeniably built directly on the Word of God?* ⚙️
- » *Do you value your Bible as dearly as people do in countries where Christianity is outlawed? Why or why not?* ⚙️
- » *What is the difference you see when you look at yourself through God's eyes rather than through the eyes of those who know your past?* ⚙️
- » *How have you made your life "forever settled" by building your decisions on Scripture?* ⚙️

Foundation

Scripture Focus: Psalm 119:89 

Pounding in the “Real Estate For Sale” sign put a sound of finality to his decision. The homeowner looked up at the place he was leaving. He sighed as he took in the beauty of his home one last time, located in the most advanced civilization of its time. The brilliant white home shone in the reflection of the sun. His wife would be leaving behind indoor plumbing and an indoor cook stove. Ur’s fresh market of any food imaginable would become a faint memory when they faced the rigors of desert life. The gold, the colored pens, the advanced schools, and much more would all be fading memories as they headed west.

Why were Abram and Sarai leaving their homeland? Because God said to. (See Genesis 12:1-2.) And Abram lived by every one of God’s words. Abram and Sarai chose to leave the comforts of advanced Ur to live in tents. Instead of running water, they would have to run for water. Instead of indoor cooking, their food would be cooked in the mercy of the great outdoors. Instead of safe, clean walls, their new home would be held together by poles, ropes, and stakes.

Though he could not explain to his wife exactly where they were going, Abram went forward simply on what God had said. That does not seem like much to go on. Similarly, you cannot show your friends or family members exactly where you are headed. You take by faith the “Land of Promise” with Jesus for eternity. Such hope might seem as unstable as a tent, but when God speaks, His Word is more stable than that home left behind in Ur.

Frame

If a giant machine picked up your dwelling place and set it on a sand dune, you would be in serious trouble. Unfortunately, many people live in a worse sort of displacement. They have nothing solid on which to build their lives. **Everyone needs a starting point for life.** Emotions, energy, health, purpose, or dreams are not foundational material. We need a footing that will last forever.

Forever is a really long time. This is why we rejoice to read, “Forever, O LORD, Your word is settled in heaven” (Psalm 119:89, NKJV).  Your life has to have something solid as a starting point, and it does: God’s Word. Feelings will fluctuate, dreams may fade, and life purposes might change, but God’s Word will not.

While many know the strength and power of God’s Word, they look at it more as a ruler to measure their lives by, rather than a starting point for all they do. So much instability in our world today comes from people who do not have anything “forever settled” in their lives. A new doctrine comes along or a social trend emerges and many begin to reflect these influences in their lives. You can tell a true Bible believer because they think the same and act according to the same godly principles, no matter what situation they face.

One reason many people do not trust the Bible is because liberal scholars have said we do not know for sure if we even have the Word of God. Scholars who did not base their lives on Scripture have presented all kinds of objections to solid faith in a solid Bible. They make the Bible a completely man-made book. A book that contains much wise teaching, but only a book and nothing else. Soon, former believers begin making their decisions based on emotion or logic. The end result is a humanistic, self-serving gospel that is only concerned with our happiness in this life.

 **Have you experienced moments of doubt in God’s Word?**

 **How have you overcome those moments of doubt?**

Every generation has seen an attack on the written Word of God. 🖋️ 📖 Still the text has survived, and evidence attests to its authenticity. The writings of legendary individuals such as Aristotle, Confucius, or Zoroaster are extremely limited—most likely composed years after their deaths. Even the renowned *Beowulf* manuscript has only one ancient copy in existence. However, thousands of manuscripts exist to confirm that the Bible we use today is the same Word of God the first believers held in their hands. May we cling to it as dearly as suppressed believers today in mainland China and Christian converts in Islamic countries hold to any copy they may obtain.

God's word was clear when He called Abram out of Ur. (See Acts 7:2-4.) 📖 This once-great city, located in modern day Iraq, housed much gold, troughs for channeling water indoors, kitchen stoves with chimneys, and “pens” with colored ink. Local schools appear to have taught math, astronomy, and medicine. There seems to have been no reason for Abram to leave such a sophisticated society, other than trusting what God said.

God calls us all to leave something behind. The disciples left behind their businesses. Some today have left behind their own country to travel to a different land and share the gospel. All, however, must leave behind the old life which was governed by principles of selfishness and sinfulness.

⚙️ **What is something you have felt to leave behind as you have grown in your walk with the Lord?**

In Ur, excavations have shown evidence of human sacrifice. No doubt Abram was glad to get away from such wickedness. There is no telling how many of his family members were involved in a pagan religion, but he had to leave them behind. You, too, will have friends and family members you have to move on without. They can no longer be your best friends because their values and yours will clash. For as long as you cling to them, you will not be clinging to the Word of God. It took Abram a while to realize this, but after burying his father and splitting off from his nephew, he was able to pursue God without distraction.

No doubt Abram was shocked at this part of the promise. How could he start a nation? He did not even have his own child! **God's Word does not just give us guidelines; it gives us hope for the future.** 🖋️ 📖 God had plans for Abram to have thousands of descendants, yet the man was seventy-five and his wife was sixty-five. They had never shopped for carpet or paint for a nursery. It was impossible for them to have children. This is why we must take God's Word by faith because He promises the impossible.

The Word of God leads you to believe and expect things that logic, emotion, or experience could never inspire. 🖋️ 📖 Logic will not cause a person to think he will live forever in an immortal body. Emotion will not give one a sense that the future is full of joy and peace. Experience will not lead anyone to believe that Jesus has prepared for them a place that is out-of-this-world. Only the promises of Scripture give beyond this life.



Abram accepted God's word so completely that he started telling everyone he met. God later told him that he would be the father of a multitude. To reflect that destiny, God changed Abram's name to Abraham, meaning “father of a multitude.” (See Genesis 17:5.) 📖 Whenever he had to introduce himself to someone new, Abraham was saying, “I am a father of a multitude.” Likewise, we must share the hope we have with everyone. Do not hide your identity as an Apostolic Christian. Tell them of the one true God you serve and the hope you have in Him.



⚙️ **Why is sharing our hope with others so important?**

Imagine how hard it must have been for Abraham to “see” what God was talking about. Repeatedly, the Lord gave His word that Abraham would have countless descendants—all this after his wife was well beyond child-bearing age. What did Abraham do? **He chose to see himself the way**

LESSON BIG IDEA: Because God's Word gives life, we can receive the strength, hope, and direction it gives.



God saw him, rather than the way the facts appeared. A doctor might look at the situation and say, "I'm sorry, but you cannot have children." Abraham, however, looked at God's prognosis and said, "I'm going to be a daddy!" Because Abraham took active faith in God's word, the Lord accounted it to him for righteousness. (See Genesis 15:6.) 

Our active faith today must not only accept the history of Jesus Christ but believe that His death, burial, and resurrection apply to our lives.   You, like Abraham, must actively believe that Jesus' righteousness is applied to you. Abraham left behind comfort and luxury to live in tents in a land that was not yet his. You leave your comfort zone by turning from the old ways of life and confessing your sins. Then you identify with the Promised Seed, Jesus Christ, by being buried with Him in baptism. You rise to newness of life with Him as He fills you with His Spirit.

Abraham had questions and may have faltered a few times, but he learned to hold onto God's word. You, too, will have to make the daily decision to live by faith in God's Word. God says those who are in Christ are righteous. (See II Corinthians 5:21.)  By faith, you see yourself the way God sees you. You could live your life according to the way others see you, but if you do, you will go back to the old nature of sin you once lived in. When you take by faith God's view of you, you will live in keeping with that ideal. (See Romans 6:11-13.) 

Do you worry much about what other people think of you? Why or why not?

Abraham is the father of the faith for Jews, Muslims, and Christians. For the Jews, he is their ancestral heritage—what makes them part of the chosen breed. The Muslims look to his son Ishmael as their hero. Christians, however, not only look to Abraham as an ancestor to Jesus Christ, but we also look to him as the father of the faithful. Abraham believed God and took Him at His Word. Even in the face of discouraging reality, Abraham believed God for a son. (See Romans 4:16-19.) 

Even when it looks like a situation is hopeless, we can stand on the promises of God's Word.   He will never leave you or forsake you, even if you feel alone. He will come back and bring you home to be with Him, even if life looks meaningless with no end in sight. He conquered sin and temptation, even if you feel like you will never win your struggle. He paid for your healing, even if you feel miserable beyond repair. He broke the chains of darkness, even if it feels like the enemy has the upper hand. Children of God must see themselves through His eyes. We must accept as reality what He has promised, not what we have experienced. We speak life, healing, and freedom because we know His Word and we know it is forever settled. We preach truth because lives are changed by the seemingly insignificant act of proclaiming His Word. (See I Corinthians 1:21.) 

What are some promises from God's Word you have stood upon?

May it be said of every believer, that such a person "did not waver at the promise of God through unbelief, but was strengthened in faith, giving glory to God, and being fully convinced that what He had promised He was also able to perform" (Romans 4:20-21, NKJV).  How are you going to be fully convinced? By knowing His Word and shaping your awareness of life on it. Is your self-identity built on the Word of God? Are your daydreams and goals in life shaped by what He has written? Do you crave after what God craves and live in expectancy of what He has promised? Unfortunately, too many today shape their worldview around the news media or conform to a foundation laid by social media and peer influence.

God put righteousness in Abraham's account, but not because of certain rituals he fulfilled. In God's scorebook, **Abraham was considered righteous because he was willing to stake every thought, word, and action on God's word.** ✍️ 📖 (See Romans 4:22.) 📖 Twenty-five years after the promise, God gave him the promised child—Isaac. Two thousand years after the promise, the Promised Seed came—Jesus Christ. This narrative does not exist in God's Word so we can only learn about what happened in one man's life a long time ago, but so that we are encouraged to live our lives solely trusting in the Word of God alone.

"Now it was not written for his sake alone that it was imputed to him, but also for us. [Righteousness] shall be imputed to us who believe in Him who raised up Jesus our Lord from the dead, who was delivered up because of our offenses, and was raised because of our justification" (Romans 4:23-25, NKJV). 📖

Abraham believed God's word about the Promised Seed in whom all nations of the earth would be blessed. (See Galatians 3:16.) 📖 Do you believe in the Promised Seed insomuch that you identify with Him and not your past or your experiences? Do you see yourself as dead with Christ so that you can also live with Him, both now and in eternity? Paul wrote, "Reckon yourselves to be dead indeed to sin, but alive to God in Christ Jesus our Lord" (Romans 6:11, NKJV). 📖

Finish

Amy Carmichael responded to the prodding of the Lord to go to India. A local person asked, "Why are you here?" She did not have a clear answer, but she knew she was doing what God had called her to do.

"A life-changing experience took place in 1901. A little five-year-old girl, named Pearl Eyes by Amy, was brought to her by an Indian woman. The child had been sold by the mother to the temple, and there she was being prepared and taught all the degradation of temple prostitution. Twice she had run away only to be caught, carried back, beaten, and subjected to the terrible perversion of that Hindu temple. Finally, as she was running away again at night, she met with this understanding woman who brought her to Amy, who gathered the child up into her lap and picked up the rag doll and gave it to the child to play with. It was then that she really truly understood the evil of the temple practice. Little Pearl Eyes talked freely as she played with the doll. She told Amy things that they did to her in the temple, demonstrating them using the doll. The date was March 7, 1901. Amy never forgot that day nor the child's story. It was terrible beyond imagination. This was the beginning of her rescue of these children who had been dedicated to the temple gods."

She rescued one and then another. Many years later, she had rescued hundreds of girls from slave prostitution.

(Excerpts taken from <https://www.gfamissions.org/missionary-biographies/carmichael-amy-1867-1951.html>, accessed October 13, 2015.)

Believers must build every aspect of their lives on every principle of God's Word. Is your home-life built on God's blueprint in His Word? A selfish generation looks to God for happiness. They want miracles without commitment. Abraham did not just believe what God said about God; he believed what God said about Abraham. What is God's Word saying about you?

⚙️ **Reflect on your life for a moment. Do many of your choices and actions reflect popular culture, or are they undeniably built directly on the Word of God?**

⚙️ **Do you value your Bible as dearly as people do in countries where Christianity is outlawed? Why or why not?**

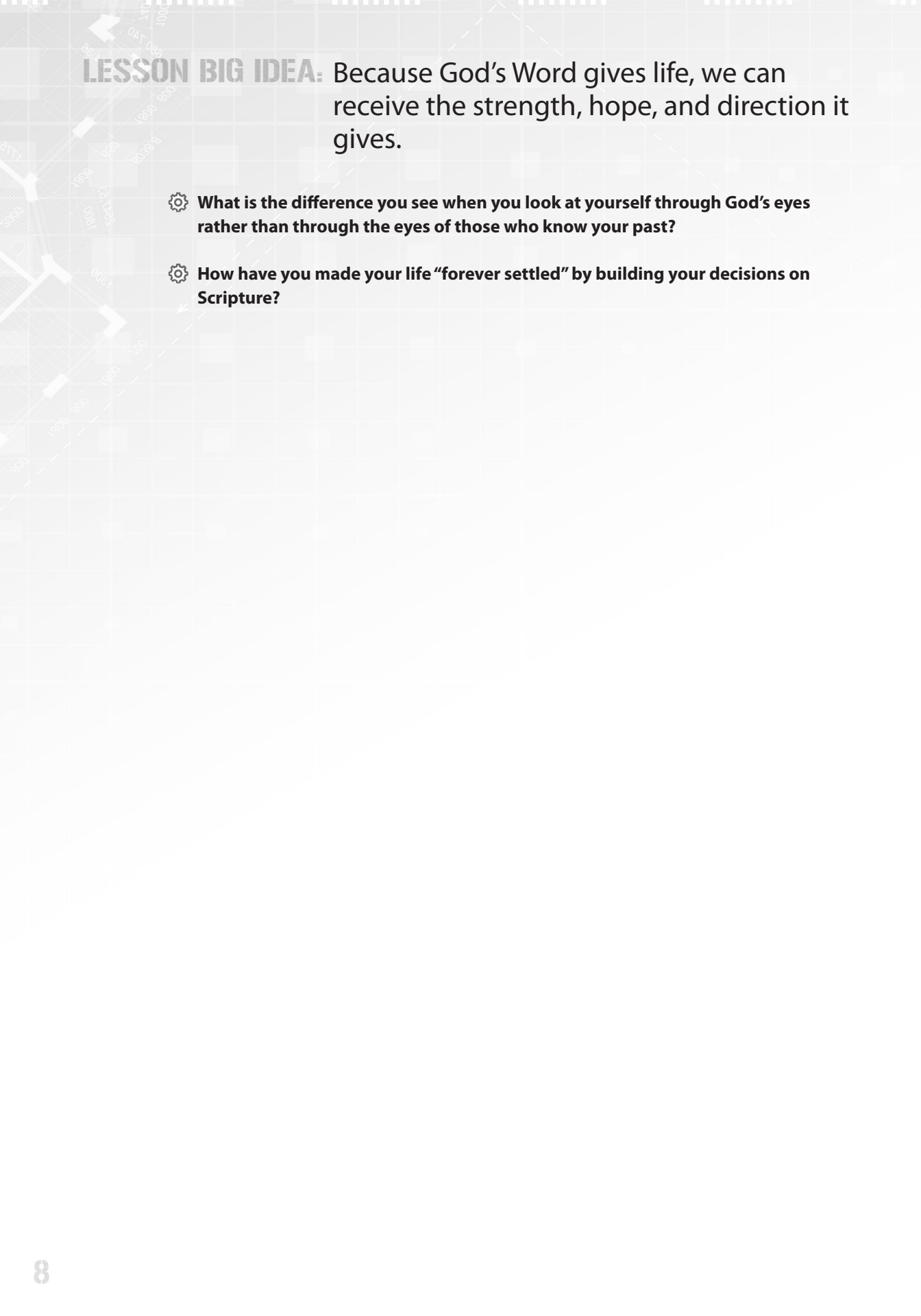

LESSON BIG IDEA: Because God's Word gives life, we can receive the strength, hope, and direction it gives.

- ⚙️ **What is the difference you see when you look at yourself through God's eyes rather than through the eyes of those who know your past?**
- ⚙️ **How have you made your life "forever settled" by building your decisions on Scripture?**

Small Group Leader's Guide

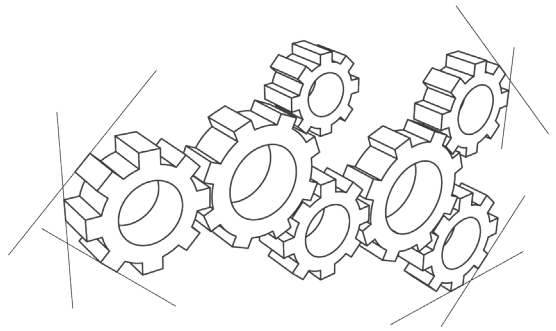

The Living Word: *Forever Settled*

Opening Question: Would you rather move every two years or stay in one place for your entire life? Why?

Scripture Focus: Psalm 119:89

Tell the story of Abram and Sarai leaving Ur on page 44.

Group Discussion:

- Have you experienced moments of doubt in God's Word?
- How have you overcome those moments of doubt?
- Why is sharing our hope with others so important? ⚙️
- What are some promises from God's Word you have stood upon?
- Do you value your Bible as dearly as people do in countries where Christianity is outlawed? Why or why not?
- What is the difference you see when you look at yourself through God's eyes rather than through the eyes of those who know your past? ⚙️
- How do you know your life is on a solid foundation?
- How is hope an anchor for your soul?
- Why is it comforting to know that God never changes? ⚙️
- Why are you thankful for God's Word?
- Why is having a love for God's Word so important for the believer?
- How do you know if someone has a love for God's Word or not? ⚙️
- How do you know God's Word is true?
- Why is it difficult at times to see God at work in your life?
- How do you know God is at work in your life? ⚙️

Prayer Focus

Lord, thank You for placing my life on a solid foundation. I am grateful to know You never change and I can depend upon You. I am thankful for Your Word and want to love it more than anything else. I believe Your Word cannot lie and it can never fail. Though I cannot see all You are doing, I believe You are at work in my life because Your Word tells me so.