

CHILDREN

Our Big God



SERIES BIG IDEA

Although God is limitless, our perception of God is very limited. Therefore, we must choose to magnify Him until we see who He really is.

Lesson 1.1

Lesson 1.2

Lesson 1.3

Lesson 1.4

God Is Omniscient

God Is Omnipresent

God Is Omnipotent

God Is All-loving

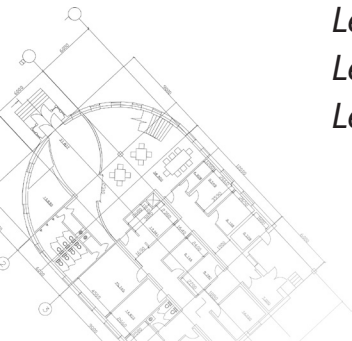



Our Big God:

God Is Omniscient

BLUEPRINT

SERIES BIG IDEA

Although God is limitless, our perception of God is very limited. Therefore, we must choose to magnify Him until we see who He really is.

SERIES MEMORY PASSAGE

Psalm 34:3

LESSON BIG IDEA

Since God knows everything, He is aware of the troubles and triumphs in your life.

BIBLICAL PASSAGE

Micah 5:2

STUDENTS WILL relate God's omniscience to their present circumstances.

Early Elementary (Grades 1-3)

TOOL BOX

FOUNDATION

- PowerPoint 1.1
- Bee magnification example: "What Does A Bee Look Like When It's Magnified 3000 Times?" by Joseph Stromberg, www.smithsonianmag.com
- Magnifying glass
- Piece of paper with "I like to eat chicken" on it ("eat" in tiny letters)
- Paper and pencils

FRAME

- Series 1 memory verse poster (**TRP**)
- Thirteen sheets of paper (one word of the memory verse written on each)
- Magnifying glass or magnifying sheet
- Circle of chairs, music, and dry erase board
- 2 lanterns
- Visual: Bethlehem (**TRP**)
- Visual: Mary, Joseph, and Gabriel (**TRP**)

FINISH

- 4 blindfolds
- Activity Paper
- Magnifying glass

SELAH

- Series song and lyrics: "The Omni"

Late Elementary (Grades 4-6)

TOOL BOX

FOUNDATION

- PowerPoint 1.1
- Bee magnification example: "What Does A Bee Look Like When It's Magnified 3000 Times?" by Joseph Stromberg, www.smithsonianmag.com
- Magnifying glass
- Piece of paper with "I like to eat chicken" on it ("eat" in tiny letters)
- Paper and pencils

FRAME

- Series 1 memory verse poster (**TRP**)
- Two sheets of paper (half of the memory verse written on each)
- Magnifying glass or magnifying sheet
- Circle of chairs, music, and dry erase board
- 2 lanterns
- Visual: Bethlehem (**TRP**)
- Visual: Mary, Joseph, and Gabriel (**TRP**)

FINISH

- 4 blindfolds
- Activity Paper
- Magnifying glass

SELAH

- Series song and lyrics: "The Omni"

FOUNDATION

Early Elementary (1-3)

Late Elementary (4-6)

Sing the series song 📺 “The Omni” at any time during this lesson. It is an additional learning tool and can be inserted at any time. Download the link and watch the video of Apostolic young people singing to the Lord.

Magnifying God

Model It

Share this link about the magnification of a bee with students. <http://www.smithsonianmag.com/science-nature/what-does-a-bee-look-like-when-its-magnified-3000-times>

After the conclusion of the share time, present a magnifying glass. Just for fun, have students take turns coming to the front of the class to show what their faces look like behind the magnifying glass. Write the words “I like to eat chicken” on a piece of paper with the word “eat” extremely small. When the paper is held in the front of the room, the children can only read the words “I like to --- chicken.”

- **Does this sentence make sense? Why not?** Some may respond that there is a word missing; if they do, respond by asking if they are sure about that.

Select two students to come forward and read the sentence with the magnifying glass. By using the magnifying glass, they can see the word “eat.”

Discuss how this is sometimes how we see God in our lives. We see parts of Him here or there. We feel His presence at church and in our prayer time, and He is noticeable to us just like the big words of this sentence. However, just like this sentence didn’t make sense until we took the time to look a little closer and magnify it, so we must realize that God is part of every aspect of our lives. All we need to do to recognize His presence is to magnify Him. He knows everything about us, whether we realize it or not. He knows all our troubles, whether we realize it or not. He knows our lives—yesterday, today, and tomorrow. Sometimes we forget and assume that He doesn’t know everything, just like we could have accidentally assumed that “I like to chicken.”

Guided Practice and Reflection

- **Have you ever had a problem that you thought God didn’t know or care about? If so, why did you think God didn’t know or care?**
- ☆ **Have you ever thought you had a problem that was too big for God to handle? If so, why?**
- ☆ **Have you ever felt like God didn’t want to help you with your problem?**

When we understand that God knows all our problems and all the solutions, we won’t limit ourselves in believing what God can and will do for us! He is bigger than we can imagine!

Superman or Two-Year-Old Child?

Brainstorm

Ask students to imagine that a large tree fell on their house. No one is hurt and they shouldn’t worry because you know someone who can get the tree off their house.

- **What would you think if I showed up with a two-year-old child to help?**
- **What about if I showed up with Superman?**

If I showed up with the two-year-old, you might laugh or wonder if I had gone crazy because we know there is no way a little child could lift a tree off a house. However, if I showed up with Superman, you wouldn’t laugh or question my sanity; you would celebrate! You may even anticipate that he will move the tree with his pinkie finger!

When we have trouble in our lives, God knows how to fix it! He knows how the problem started and He knows how to end the problem. However, sometimes we forget that God is real and present in our lives, so much greater than a fictional character like Superman. God knows about all of our lives and the lives of others. You

Early Elementary (1-3)

should always view God as your Superman. In fact, if you were to compare God to Superman, Superman would look like a little two-year-old. God is all-knowing and able to guide your life and to keep you safe at all times, no matter what happens!

Write

Give students paper and pencils. Ask them to think about a problem they have had or are having in their lives. Have them draw their problem on the sheet of paper. Then have them write the words "God Knows" at the top of the paper. Encourage students to have faith in God because He knows and can help them with their problems.

Late Elementary (4-6)

Write

Pass out paper and pencils. Ask students to write two problems or difficult situations they had in the past. Next to each problem, if they had a hard time believing God could help them, have them draw a picture of a two-year-old child. If they had no trouble believing God could help them, have them write a big S. Share personal examples. Afterward have students share one or both examples.

FRAME

P **MEMORY VERSE:** "O magnify the LORD with me, and let us exalt his name together" (Psalm 34:3).

Magnifying the Memory Verse

Guided Practice

Before class, write or type the memory verse on thirteen sheets of paper (one word per paper). The words should be extremely small, but large enough to be read without straining one's eyes. Display the memory verse poster where it is visible to all students.

Distribute these papers to thirteen students. Using the posted verse, have students line up in verse order. Each student states his or her word, one at a time, in the proper order.

Collect the papers, mix them up, and redistribute them (including new students). Encourage the group to speed up the process each time.

Once memorized, allow students to take turns standing in front of the class, quoting the entire verse looking through a magnifying glass or magnifying sheet. Challenge onlookers to see how long they can refrain from laughing.

Magnifying the Memory Verse

Guided Practice

Before class, write or type the memory verse on two sheets of paper (half of the verse on each sheet: "Oh magnify the Lord with me / and let us exalt his name together.") The words should be extremely small, but large enough to be read without straining one's eyes. Have the memory verse poster displayed so all can see.

Divide students into two groups. Give a sheet of paper with half of the verse to each group. Have the groups take turns reading the verse. One group will say, "Oh magnify the Lord with me," and the second group will follow with, "and let us exalt his name together." Repeat the verse several times. Once the verse is memorized, allow student volunteers to stand in front of the class and quote the entire verse with their faces pressed up to a large magnifying glass or magnifying sheet. Challenge students who are watching those quoting to see how long they can refrain from laughing.

Reflection

Magnify means to make something look bigger than it really is. The magnifying glass doesn't change the actual size of something, but rather it changes how we see the item being magnified. The magnifying glass made the words bigger for us because we had trouble seeing them. God fills the universe in which we live, yet sometimes we don't pay attention to how awesome He is.

- How can we remind ourselves of God's greatness?
- How can we magnify God in our lives?

- How is seeing through a magnifying glass like the way we see God?
- How does nature and God's creation let us know that God is awesome?

Late Elementary (4-6)

- **Why do you think we forget about how amazing God is?**
- **How can we change our perspective of God and His greatness?**
- ☆ **What are ways we can magnify God to make Him bigger in our lives?**

Early Elementary (1-3)

Music Memory Game

Place chairs in a circle formation or have students stand in a circle. Display the memory verse poster or write the verse on a dry erase board. Start the music and give the magnifying glass to a student to pass around the circle. When the music stops, the student with the glass will put the magnifying glass in front of his or her face and say the verse. Keep playing until everyone has had a chance to say the verse.

Biblical Passage: Micah 5:2

 Read Micah 5:2 using choral reading (all together) or echo reading (repeat after the teacher).

When things are unknown to us it can be scary, but thankfully we have a God who knows all the answers. He also understands that we are human and we are not perfect.

Quickly turn off the lights for ten seconds and then turn them back on. Ask students to recall a time when they were scared of the dark. If no one shares about being afraid of the dark, relate a time you were scared of the dark. Explain how what you couldn't see and didn't know scared you, but once the light was turned on, fear left because you could see clearly.

The prophet was saying Bethlehem would be the place a ruler would someday be born. He didn't know when it would happen.

Late Elementary (4-6)

Biblical Passage: Micah 5:2

Guided Practice

 Read Micah 5:2 using choral or echo reading. In this passage God is speaking through the prophet about a future event. This event is so great that it will change things forever. God is omniscient, which means He knows all things. He knows not just all things in the present or the past but even the future!

- **Have you ever wanted to know the future? Why or why not?**
- **How does knowing that God knows the future make you feel?**
- **If God knows the future, how does this affect the way you and I should view our problems?**

This passage is one example of our great God declaring what will happen in the future because He has all the answers for everything. This includes your life!

Bible Lesson

Prior to the lesson, light the lanterns and turn off the lights. Use PowerPoint 1.1.

- **What is the smallest town you've ever visited? Describe it.**

 Show Bethlehem visual (TRP). We're going to explore a small, rural, obscure town in today's lesson. This town was smaller than all the others around it. It didn't have a highway or wide roads, it just had narrow dirt paths. It didn't have skyscrapers or temples; it just had small houses and a sufficient outdoor market place. It was surrounded by cornfields, vineyards, and farms. The name of this small town was Bethlehem. God said in His Word, through Micah the prophet (Micah 5:2), that even though Bethlehem seemed insignificant, someday a great ruler would come from it!

One night something miraculous happened in this town. Some very tired travelers journeyed to Bethlehem. These travelers wandered through the countryside past vineyards and farms. There were lots of them! As they got closer to their destination, the warm glow of the town lanterns seemed to beckon them. They trampled the dirt path down Main Street and filled the motels. Among this caravan of tourists, there were some special travelers: Joseph and Mary.

 Show Mary and Joseph visual (TRP). Joseph was a caring, protective man and Mary was a sweet young lady who was about to have a baby. They were on their way to pay their taxes, but had to find a place to spend the night. They too followed the dirt path and looked for a place to sleep. They were so tired of walking and traveling! Mud caked

Early Elementary (1-3)

the sides of Joseph's aching feet. The tired donkey that carried Mary for miles plodded wearily, coated with a thick layer of sweat and dirt. He didn't want to go another step. This lady, who he knew was important, was also very heavy! Mary shifted her weight and slid off the donkey. She yawned and forced her drooping eyes to stay open. She felt like she just might have this baby tonight in this town. She prayed silently that Joseph would find a resting place for them soon!

Joseph knocked on a door and asked the homeowner if they could sleep there. A burly impatient man opened the door and gruffly replied, "No, we have no more room!" Joseph walked to the next house and knocked again. The answer was given again, no rooms available. No room anywhere. All the other travelers were crowded into the houses and inns. It was getting late and Mary was so tired. Joseph kept trying to find a place for them. His shoulders sagged as he knocked on the last door. The man had compassion on the exhausted, desperate travelers. He said, "I don't have any rooms, but you can sleep in my barn."

Mary and Joseph found a place to rest and an important king found a place to be born. The

Late Elementary (4-6)

king, the important ruler that Micah declared was coming, was born in that rustic, rural stable. Does anyone know the name of this king?



Jesus was born that night! The ruler God's Word said would be born in that small town of Bethlehem many years before, was born! It happened! How did it get written down before it happened? Because God is omniscient and knows everything!

Conclude the Bible lesson by singing the first verse of "Oh Little Town of Bethlehem." Locate the song on YouTube or sing it a cappella.

Discussion Questions:

- **If God knows everything, what does He know about you?**
- **Can we stop worrying about our problems if God knows all things?**
- **If you know someone who is worried or scared, what could you say about our all-knowing God that could help?**
- ☆ **You can't see God, so how can you believe He knows what's best for you now and in the future?**
- ☆ **How can the fact that God knows all things help you with a problem you're facing?**

FINISH

Take out the blindfolds and blindfold two students. Tell them they are going to be led by some all-knowing friends. After the first two students are blindfolded and cannot see, blindfold the leaders. Now the blind are leading the blind and no one knows where they are going.

Without God, we are blind. Even those who lead us need God to lead them. We need God in our lives because God knows everything. God's omniscience or all-knowing ability will never lead us astray. He can see what is up ahead years, decades, and even centuries in advance as we saw by our Bible lesson today.

Just as important is that God knows what is happening in our lives at all times. He knows our hurts and disappointments. He knows if we are having trouble at school or at home. Nothing is hidden from God; He is omniscient. Rest in knowing that God knows and cares for you.

Review the instructions for page two of the activity paper—Family Connection—and give students a chance to discuss how they will carry out this assignment. If your class has consistent attendance, consider offering a reward for those who return the Family Connection and provide time in the class to discuss the activity.

Activity Paper

Have students complete the activity, "God Knows Me."

Activity Paper

Have students complete the activity, "Tiny Mad Libs."

SELAH

Early Elementary (1-3)

Late Elementary (4-6)

Prayer

Pray with students.

- **Why do we think it is easier for us to try to solve everything all by ourselves?**
- **Why do you think that God doesn't always fix things right away even though He knows when there is a problem?**

Reflection

P Read Job 23:10. Give students five to eight minutes to read and reflect.

- **What did Job mean when he said, "But He knows the way that I take."**
- **By looking at God's creation and nature, how can you be sure that God is all knowing?**
- **How does it make you feel that God knows everything about you, including your future?**

Sing the series song  "The Omni." Download the link and watch the video of Apostolic young people singing to the Lord.

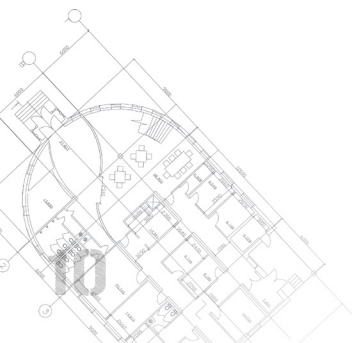

YOUTH

The Omni Attributes of God

A series by Daniel Koren



SERIES BIG IDEA

Although God is limitless, our perception of God is finite.
Therefore, we must actively magnify Him
until we see Him for who He is.

Lesson 1.1

Lesson 1.2

Lesson 1.3

Lesson 1.4

God Is Omniscient

God Is Omnipresent

God Is Omnipotent

God Is Omnibenevolent

The Omni

God Is Omniscient

BLUEPRINT

SERIES BIG IDEA

God is limitless, but our perception of God is finite. Therefore, we must actively magnify God until we see Him for who He is.

LESSON BIG IDEA

Since God knows everything; He will not be surprised by the troubles that arise in your life.

LEARNING TARGET

To learn to trust God in all of our situations.

KEY SCRIPTURE PASSAGE

Micah 5:2

SUPPLIES

blindfolds, timer

FOUNDATION

While traveling across the country from his home state of Washington in the 1970s, Ken Gaub stopped the vehicle for a rest. Letting his wife take the kids into a restaurant, he got out to stretch his legs and think—actually, to pity himself. It was a dry time in life and he complained to the Lord about how empty and drained he felt. While consuming a soft drink on this little stroll, he heard a pay phone ringing at the side of the road.

The ringing phone disrupted his gloom and caused him to glance around wondering if someone would answer it. Realizing one does not often receive a call at a pay phone, he began to wonder if it was an emergency. He stepped into the booth and reached for the receiver.

The voice on the other end said, “Long distance call for Ken Gaub.”

Ken paused for a moment of shock. He tried to explain the randomness of his situation, but the operator interrupted, “Is Ken Gaub there? I have a long distance call for him.”

After blathering for a moment, Ken said, “Yes, he is here.”

In the background another voice said, “Yes, that’s him operator.”

The operator connected the call, and Ken listened to the woman introduce herself. She was desperate for help. Through her tears she said she had just written a note explaining why she was about to take her own life. She then remembered a conversation with Ken, and she felt to reach out to him. Perhaps he could help her.

“I knew that was impossible because I didn’t know how to reach you, I didn’t know anyone who could help me find you. Then some numbers came to my mind, and I scribbled them down. . . . Are you in your office?”

Amazed, Ken said, “Ma’am, you won’t believe this, but I’m in a phone booth in Dayton, Ohio!”

As they both realized this was more than a random accident, Ken sensed the power of the Spirit giving him wise words to lead this woman out of her despair. After ending the call on a positive note, the once-discouraged man nearly raced back to his wife saying, "Barb, you won't believe this! God knows where I am!" (*God's Got Your Number*, Ken Gaub).

Opening Discussion

- Have you ever wondered if God knew where you were and what was happening in your life? Can you give an example?
- How do you know God knows where you are and what is happening in your life?

Middle-School Exercise:

1. Set up an obstacle course using chairs or other available objects as obstacles.
2. Split students up into pairs or divide the class into two or three teams.
3. Blindfold one student and have the other student(s) direct him or her, using verbal commands, around the obstacle course.
4. The pair that completes the course the fastest wins.
5. Explain how we are like blindfolded people walking through life and how God knows where all the obstacles are and how to get around them.

Senior-High Exercise:

1. Blindfold a single volunteer.
2. Tell the volunteer what he or she is looking for. Have the volunteer attempt to find a hidden object within the room.
3. Instruct the other students to attempt to give directions, all at the same time as loudly and as distractingly as possible, to help the volunteer find the object they have no knowledge of.
4. After the confusion, quiet the room and personally direct the volunteer, maybe even by the hand.
5. Explain how the world is always trying to direct us in confusing manners, but God knows the source and location of what we need at all times if we simply listen and wait on Him and His timing.

** Ask your students about a time in their lives when they felt lost. This can be interpreted as being physically lost or even spiritually lost, so allow your students to determine the nature of the question on their own. This may be a story about getting lost while driving, being forgotten in the aisles of a grocery store when they were little, or even an emotional period in their lives in which they felt they had no direction. If your students are having trouble remembering one of these instances, think of a time when you were lost and share it with the class to relate to their own personal experiences or to help them remember a time when they felt those same emotions.*

FRAME







I. The Comfort Zone

- A. Joseph and Mary took a journey that pulled them out of their comfort zone.
- B. Instead of being able to get their home ready for the birth of their baby, both Mary and Joseph were required to leave the familiar behind and were required to travel to Joseph's hometown for a census.
 1. A census was required for an official count of all the people under Roman rule.
 2. Families were forced to return to their hometowns to acquire the most accurate counts from across the empire.
- C. Mary had to travel out of her comfort zone and try to find a comfortable place to give birth to her first child.

LESSON BIG IDEA: God Is Never Surprised



- D. Perhaps she wondered where God was in that moment.
1. Did God have her number?
 2. Did He know what He was doing?
 3. How could He send the Messiah into the middle of a regional census, putting Mary far from home and all things familiar?

II. The Birth of Christ

- A. Even in the middle of the perfect will of God, life can seem random and full of chaos.
1. Mary must have felt relief when she saw the shepherds appear, worshiping her Son.
 2. Clearly, God knew where she was or the shepherds would not have found the child Jesus.
 3. Not only was the Lord aware of what was happening moment by moment, He was aware of the details surrounding this event before it happened.
- B. **The accounts of the birth of Jesus demonstrate that God knew about it long before it happened. God knew:**
1. The Redeemer was coming (Genesis 3:15). 
 2. He would come from the tribe of Judah (Genesis 49:10). 
 3. He would be born in the little town of Bethlehem (Micah 5:2). 
 4. His father would be a man named Joseph (Matthew 1:1-17). 
 5. He would be born of a virgin (Isaiah 7:14). 
 6. His mother would be named Mary (Luke 1:26-35). 
- C. Seven hundred years before Jesus was born, Micah prophesied about the insignificant town of Bethlehem. What looked like a coincidence for Mary and Joseph proved to be so much more. Even if Mary had felt alone and afraid of having a child, God knew where she was and what was going to happen long before it did. Our God knows the end from the beginning.

 *Would you prefer to know the details of your future? Why or why not?*

 *Why do you think God withholds information about our futures?*

- D. **The omniscient God calls events before they happen.**  
1. Jesus could have been born in Bethlehem without prophetic mention of the event. However, the fact the Lord told of His birth location long before it happened gives us a glimpse of how far reaching His intellect is.
 2. No human can do such a thing. God's omniscience brings Him glory.
 3. **He does not work randomly and without purpose.** He has a master plan and we are privileged to find ourselves in it, just as Joseph and Mary did.
- E. Contrary to the thinking of many, the devil is not all-knowing. The enemy's plan was to prevent the Lord from redeeming His people. To do this, he had to destroy the Messiah.
1. Even though the prophecy of Micah was hundreds of years old, the enemy did not realize the birth of the Messiah would be in Bethlehem.
 2. Herod tried to kill all the infant boys in Bethlehem after hearing of the birth of this King. He was too late; the Messiah had already escaped to Egypt with His family.
 3. If the devil were omniscient, he would have attempted to kill the Messiah as soon as He was born.

 *Why is it comforting to you to know the devil is not all-knowing?*

F. **Before birth, we were in the mind of God.** ✍️ 📖

1. He planned us out and designed us according to His master plan. (See Psalm 139:13-16.) 📖
2. The Lord told the prophet Jeremiah He knew him before He made him in his mother's womb and had already chosen him as His spokesperson. (See Jeremiah 1:5.) 📖
3. Even the king of a godless nation was factored into His plan. (See Daniel 2:28-29.) 📖

- ⚙️ *What do you think of your abilities and inabilities as you view them both as God's purposeful design for your life?*
⚙️ *Why do you think God made you like you are?*

✂️ *Discuss a time in your life when you felt helpless and out of control, leading you to make wild decisions or assumptions. Then discuss a time when you felt those same emotions but, instead of panicking or acting irrationally, you chose to trust in God's wisdom and ability.*

III. The Content of Our Hearts

A. **God knows what is in our hearts.** ✍️ 📖





1. Only the Lord knows your heart and how wicked it could be. Only a fool thinks he is as smart as God to see inside his own heart. (See Proverbs 28:26.) 📖
- B. Solomon, the wisest king, understood the Lord can see into our thoughts and tests our hearts in all we do. (See I Chronicles 28:9.) 📖
1. A person can do great things from very dark motivations such as pride or manipulation.
 2. God is not impressed by our successes or heroism when we live by trusting in our own abilities. God is only impressed by those who live by desperate faith in His ability to do what only He can.
- C. Job—the man who could talk for hours trying to justify himself, all while interrogating God—finally got a glimpse of how amazing God is.
1. Every person must come to recognize not just the doctrine of God's omniscience but also the reality of His full awareness of every thought and desire within us.
 2. Fear comes when we first recognize this truth; joy comes when we learn to live by it.
- D. In spite of His omniscience and ability to know every thought and desire in the human heart, God still searches for something.
1. Yes, the "eyes of the Lord run to and fro throughout the whole earth" looking for those whose hearts are perfect toward Him (II Chronicles 16:9, KJV). 📖
- E. Since we cannot hide who we are or what is in our lives, **we must acknowledge the Lord's insight into the inner workings of our lives.** He is acquainted with all our ways. (See Psalm 139:3.) 📖
1. There is nothing we say that He does not already know before we say it. (See Psalm 139:4.) 📖
 2. Therefore, rather than do like most humans who try to hide the contents of their hearts, we invite Him not only to scan our hearts but to make a clean sweep of it as well. (See Psalm 139:23-24.) 📖

⚙️ *Why do you think David wrote "Try me" when talking about his thoughts?*

A. **Many people try to hide their sin**, while many people cloak their sin because of pride. ✍️ 📖

1. They may be so clever at their hypocrisy that they deceive themselves into believing God has forgotten and will never see it.
 2. Individuals justify their own actions as not being a big deal, but the Lord analyzes the heart of the matter. (See Proverbs 16:2.) 📖
- B. One can boast about being a good person, but the Lord knows the secrets of our hearts and truly understands our behaviors.

LESSON BIG IDEA: God Is Never Surprised

1. When Samuel went to anoint a king over Israel, he almost picked the wrong one because the young men he examined looked so good and wise. However, the Lord told him to pass by the obvious choices and choose the one He chose according to his heart.
 2. The one He chose not only had a heart after God, David also knew the Lord well enough to know He saw into David's soul. David raised his son Solomon to understand that God rewards people according to what He sees in their hearts. (See I Kings 8:39.) 
- C. Abimelech looked like he had evil intentions against Abraham and Sarah, for he had taken the woman with the intention of Sarah becoming his wife. While this looked quite wrong from the outside, the truth was Abraham had not told the king the truth that Sarah was his own wife.
1. The Lord told Abimelech, "I know that thou didst this in the integrity of thy heart" (Genesis 20:6, KJV).  While those who make up stories to cover their sin will not be blessed, the Lord understands when we innocently get into a mess.
 2. Regardless of what others think, it is a reassuring feeling to know the Lord is aware of the truth, seeing not only our thoughts but our intentions.
- D. **God knows the details of our lives.** Not only does the Lord know us in every detail, He also knows every detail about what goes on around us. God's omniscience gives us hope because He knows our needs before we even ask Him. (See Matthew 6:8.) 
1. When an outcast servant faced a distressing situation in the wilderness, she discovered the Lord had been looking out for her and her child. Hagar became the first person in Scripture to ascribe a title to the Lord when she said, "You are the God who sees me" (Genesis 16:13, NIV). 
 2. What a comfort to know the Lord is watching over us even when life leaves us feeling outcast and rejected.



Can you tell of a time when you heard a preached sermon that encouraged you during a time when you felt rejected?

- E. How much joy must have flooded Mary's heart when she heard the shepherds tell of the angels singing. Not only did the Lord know where she was in little Bethlehem, but He sent an angel choir to celebrate the birth.
- F. Not too long after Jesus' birth, Mary and Joseph had to flee to the neighboring country of Egypt to get away from wicked King Herod, who wanted to kill the Child.
 1. That situation brings to mind another event involving oppression from a cruel enemy.
 2. The people of Israel suffered slavery for hundreds of years. When they cried out to the Lord, He heard them and was aware not only of their bondage but also of whom He would send as their rescuer.
 3. He told Moses exactly how he was to proceed with getting the people out of Egypt and how the Pharaoh would respond to his efforts.
 4. Once again, the Lord knew the whole story—even the part that had not happened yet. He knows your story, too.

FINISH

Reggie Jackson was a superstar ballplayer. In one particular instance, Reggie felt he should be allowed to make his own decision to steal second base. However, Earl Weaver, the manager of the Baltimore Orioles, would not allow any player to steal a base unless he got a signal to do so. Instead of waiting for the sign to steal second, Reggie went on his own. He easily made it, sliding in at second. Feeling vindicated, Reggie expected Weaver to realize he could call his own plays. Later, the manager took Reggie aside and explained to him what had actually happened on the diamond. The batter after Reggie was Lee May, one of the team's best power hitters, only behind Reggie Jackson himself. After Jackson stole second, the pitcher intentionally walked May, placing him on first base and literally taking the bat out of May's hands. When the next batter did not perform well, Weaver sent in a pinch hitter to hopefully drive the base runners home. Unfortunately, this left the team without bench strength later in the game. (Thomas Boswell, *How Life Imitates the World Series*)

Like Jackson, many people assess things from their own perspectives and make decisions without seeking the Lord, their Manager. He sees more than we do and has the big picture in mind. If we want to win in this "game," we have to look for His cues and take our signals from God's Word, not our own experience. Jackson was a star, but he could not see the big picture alone. No matter how long a person has served the Lord, he or she must continually rely on the One who knows all things when making any decisions. Fortunately, we are on the winning team.

Jesus gave us the good news that our giving, fasting, and praying are all seen and rewarded by the One who sees in secret. He not only sees what good we do discretely, but He also sees our motives in doing these things. The Lord does not just privately bless us; He makes a big deal about us and rewards us openly where everyone can see.

Because the Lord sees and knows all things, we do not have to live in fear. 🖋️📖 Since He knows all things, we do not have to feel alone or forgotten. He has our storms and chaos all in view, and He sees the big picture we cannot see.

Discussion Questions: ⚙️

- Have you ever done something after you were warned about the dangers of doing that thing?
- What was the outcome? Did you regret it?

Middle-School Finish:

1. Discuss some things you and your students may have done as children that you tried to hide from your parents.
2. At the time, these actions may have seemed unnoticeable to us, but in reality, it only took our parents moments to notice missing hair from playing with scissors or marker all over the walls because a coloring session got a little out of hand.
3. As spiritual children, even when things seem hidden, God knows immediately when something is wrong. We are only hurting ourselves when we hide these things from Him.

Senior-High Finish:

1. Lead off a discussion with something you hid from your parents when you were younger, but that they later discovered.
2. Discuss as a class the ways this hidden thing could have affected the way you acted around your parents or other loved ones who didn't know the truth. How did it affect them once they found out it had been hidden from them?
3. Allow students to share (if they are comfortable) something they tried to keep from their loved ones and how it ultimately affected their relationship in the end

LESSON BIG IDEA: God Is Never Surprised

The Big Picture

- God knows all things, whether it be about your life or your situations.
- Even though we may feel like we know what is right, we should always take the time to step back and ask God what He wants.

Final Reflections

- Are you facing any difficult decisions or situations right now in your life?
- What do you feel God is trying to teach you through this situation?
- What kinds of questions would you ask God, knowing that He knows all things?
- How can you communicate with God on a deeper level and make Him a part of your everyday life?

 *Allow students time to share what they have written.*

SELAH

Using the following points, take this time to guide your students in prayer.

- Jesus, we thank You for Your immeasurable wisdom and knowledge.
- Often times, we think we can do things on our own, but so often we fail.
- Lord, forgive us for our unbelief in You and our own overconfidence.
- Thank You for Your grace and patience that You show us every day.
- Teach us to follow after You and rely upon Your Word to show us Your will and Your way in our walk with You.

 *Allow students time to share what they have written.*

ADULT

The Omni Attributes of God

A series by Daniel Koren



SERIES BIG IDEA

Although God is limitless, our perception of God is finite.
Therefore, we must actively magnify Him
until we see Him for who He is.

Lesson 1.1

Lesson 1.2

Lesson 1.3

Lesson 1.4

God Is Omniscient

God Is Omnipresent

God Is Omnipotent

God Is Omnibenevolent



The Omni:

God Is Omniscient

A series by Daniel Koren

Lesson Big Idea: Since God knows everything, the troubles that arise in your life will not take Him by surprise.

Foundation

Scripture Focus: Micah 5:2

Tell the story of Ken Gaub on page 10.

- » *Have you ever wondered if God knew where you were and what was happening in your life? Can you give an example?*
- » *How do you know God knows where you are and what is happening in your life?*

Frame

A. The account of Christ's birth shows this attribute of omniscience.

- » Genesis 3:15
 - » Genesis 49:10
 - » Micah 5:2
 - » Matthew 1:1-17
 - » Isaiah 7:14
 - » Luke 1:26-35
 - » *Would you prefer to know the details of your future? Why or why not?*
 - » *Why do you think God withholds information about our futures?*
1. The **omniscient** God calls events before they happen.
 2. He does not work randomly and without purpose.
 - » *Why is it comforting for you to know the devil is not all-knowing?*
 3. Before **birth**, we were in the mind of God.
 - » Psalm 139:13-16
 - » Jeremiah 1:5
 - » Daniel 2:28-29
 - » *What do you think of your abilities and inabilities as you view them both as God's purposeful design for your life?*
 - » *Why do you think God made you like you are?*

B. God knows what is in our **hearts**.

- » Jeremiah 17:9
 - » Proverbs 28:26
 - » I Chronicles 28:9
 - » II Chronicles 16:9
1. We must acknowledge the Lord's insight into the inner workings of our lives.
 - » Psalm 139:3-4
 - » Psalm 139:23-24
 - » *Why do you think David wrote "Try me" when talking about his thoughts?*
 2. Many people try to hide their **sin**.
 - » Proverbs 16:2
 - » I Kings 8:39
 - » Genesis 20:6
 3. God knows the details of our lives.
 - » Matthew 6:8
 - » Genesis 16:13, NIV
 - » *Can you tell of a preached sermon you heard that encouraged you during a time when you felt rejected?*

Finish

Tell the story of Reggie Jackson on page 14.

4. Because the Lord sees and knows all things, we do not have to **fear**.

Foundation

Scripture Focus: Micah 5:2 

While traveling across the country from his home state of Washington in the 1970s, Ken Gaub stopped the vehicle for a rest. Letting his wife take the kids into a restaurant, he got out to stretch his legs and think—actually, to pity himself. It was a dry time in life and he complained to the Lord about how empty and drained he felt. While consuming a soft drink on this little stroll, he heard a pay phone ringing at the side of the road.

The ringing phone disrupted his gloom and caused him to glance around wondering if someone would answer it. Realizing one does not often receive a call at a pay phone, he began to wonder if it was an emergency. He stepped into the booth and reached for the receiver.

The voice on the other end said, “Long distance call for Ken Gaub.”

Ken paused in a moment of shock. He tried to explain the randomness of his situation, but the operator interrupted, “Is Ken Gaub there? I have a long distance call for him.”

After blathering for a moment, Ken said, “Yes, he is here.”

In the background another voice said, “Yes, that’s him operator.”

The operator connected the call, and Ken listened to the woman introduce herself. She was desperate for help. Through her tears she said she had just written a note explaining why she was about to take her own life. She then remembered a conversation with Ken, and she felt to reach out to him. Perhaps he could help her.

“I knew that was impossible because I didn’t know how to reach you, I didn’t know anyone who could help me find you. Then some numbers came to my mind, and I scribbled them down. . . . Are you in your office?”

Amazed, Ken said, “Ma’am, you won’t believe this, but I’m in a phone booth in Dayton, Ohio!”

As they both realized this was more than a random accident, Ken sensed the power of the Spirit giving him wise words to lead this woman out of her despair. After ending the call on a positive note, the once-discouraged man nearly raced back to his wife saying, “Barb, you won’t believe this! God knows where I am!” (*God’s Got Your Number*, Ken Gaub).

  **Have you ever wondered if God knew where you were and what was happening in your life? Can you give an example?**

  **How do you know God knows where you are and what is happening in your life?**

Joseph and Mary took a journey that pulled them out of their comfort zone. Instead of being able to get their home ready for the birth of their baby, both Mary and Joseph were required to leave the familiar behind and travel to Joseph’s home town for a census. Mary had to travel out of her comfort zone and try to find a comfortable place to give birth to her first child. One can only imagine how miserable that experience must have been.

Perhaps she wondered where God was in that moment. Did God have her number? Did He know what He was doing? How could He send the Messiah into the middle of a regional census, putting Mary far from home and all things familiar?

Frame

Even in the middle of the perfect will of God, life can seem random and full of chaos. Mary must have felt relief when she saw the shepherds appear, worshiping her Son. Clearly, God knew where she was or they would not have found the child Jesus. Not only was the Lord aware of what was happening moment by moment, He was aware of the details surrounding this event before it happened.

The account of Christ's birth shows this attribute of omniscience. God knew:

- » The Redeemer was coming (Genesis 3:15).
- » He would come from the tribe of Judah (Genesis 49:10).
- » He would be born in the little town of Bethlehem (Micah 5:2).
- » His father would be a man named Joseph (Matthew 1:1-17).
- » He would be born of a virgin (Isaiah 7:14).
- » His mother would be named Mary (Luke 1:26-35).

Seven hundred years before Jesus was born, Micah prophesied about an insignificant town. What looked like a coincidence for Mary and Joseph ended up proving God had their number. Even if Mary felt alone and afraid of having a child without her mother or any medical help present, God knew where she was and what was going to happen long before it did. Our God knows the end from the beginning.

- ⚙️ **Would you prefer to know the details of your future? Why or why not?**
- ⚙️ **Why do you think God withholds information about our futures?**

The omniscient God calls events before they happen. ✍️ 📖 Jesus could have been born in Bethlehem without prophetic mention of the event. However, the fact the Lord told of His birth location long before it happened gives us a glimpse of how far reaching His intellect is. No human can do such a thing. God's omniscience brings Him glory. **He does not work randomly and without purpose.** He has a master plan and we get to find ourselves in it as did Joseph and Mary.

Contrary to the thinking of many, the devil is not all-knowing. The enemy's plan was to thwart the Lord from redeeming His people. To do this, he had to destroy the Messiah. Even though the prophecy of Micah was hundreds of years old, the enemy did not realize the birth of the Messiah would be in Bethlehem. Herod tried to kill all the infant boys in Bethlehem after hearing of the birth of this King. He was too late; the Messiah had already escaped to Egypt with His family. If the devil was omniscient, he would have attempted to kill the Messiah as soon as He was born.

- ⚙️ **Why is it comforting for you to know the devil is not all-knowing?**

In a house fire, a young boy had crawled out of his bedroom window and onto the roof. This seemed to be his only way of escape. His frantic father, standing in the yard, looked up and saw his boy kneeling on the roof. Beneath the boy were flames and smoke billowing up from the eaves of the house. Stretching out his arms, his father called, "Jump, son, I'll catch you." The boy was fearful, however, and cried out, "But I can't see you, Daddy." His dad responded, "I can see you, son. And that's what matters!"

LESSON BIG IDEA: Since God knows everything, the troubles that arise in your life will not take Him by surprise.

Before birth, we were in the mind of God. ✍️ 📖 He planned us out and designed us according to His master plan. (See Psalm 139:13-16.) 📖 The Lord told the prophet Jeremiah He knew him before He made him in his mother's womb and had already chosen him as his spokesperson. (See Jeremiah 1:5.) 📖 Even the king of a godless nation was on God's radar and factored into His plan. (See Daniel 2:28-29.) 📖

⚙️ **What do you think of your abilities and inabilities as you view them both as a part of God's purposeful design for your life?**

⚙️ **Why do you think God made you like you are?**

God knows what is in our hearts. ✍️ 📖 You have no idea what is in your heart. It is "deceitful above all things" (Jeremiah 17:9, KJV). 📖 Only the Lord knows your heart and how wicked it could be. Only a fool thinks he is as smart as God, able to see inside his own heart. (See Proverbs 28:26.) 📖

Solomon, the wisest king, understood the Lord can see into our thoughts and tests our hearts in all we do. (See I Chronicles 28:9.) 📖 A person can do great things from very dark motivations such as pride or manipulation. God is not impressed by our successes or heroism when we live by trusting in our own abilities. He is only impressed by those who live by desperate faith in His ability to do what only He can.

Job—the man who could talk for hours trying to justify himself all while interrogating God—finally got a glimpse of how amazing God is. Every person must come to recognize not just the doctrine of God's omniscience but also the reality of His full awareness of every thought and desire within us. Fear comes when we first recognize this truth; joy comes when we learn to live by it.

One would think a God who can see everything and knows everything would not have to searching for anything. He never loses His keys. He has never forgotten a recipe. However, He does have to go digging for something. In spite of His omniscience and ability to know every thought and desire in the human heart, He still searches for something. This is not just a local quest, this search covers the globe. Yes, the "eyes of the LORD run to and fro throughout the whole earth" looking for those whose hearts are perfect toward Him (II Chronicles 16:9, KJV). 📖

Since we cannot hide who we are or what is in our lives, **we must acknowledge the Lord's insight into the inner workings of our lives.** He is acquainted with all our ways. (See Psalm 139:3.)

📖 A disgruntled child might talk under his breath where the parents cannot hear, but a child of God cannot whisper quietly enough to deceive his heavenly Father. There is nothing we say that He does not already know before we say it. (See Psalm 139:4.) 📖 Therefore, rather than do like most humans who try to hide the contents of their hearts, we invite Him not only to scan our hearts but to make a clean sweep of it as well.



📖 **Psalm 139:23-24**

⚙️ **Why do you think David wrote "Try me" when talking about his thoughts?**

Many people try to hide their sin. ✍️ 📖 Many people cloak their sin because of pride. They may be so clever at their hypocrisy that they deceive themselves into believing God has forgotten and will never see it. Individuals justify their own actions as not being a big deal, but the Lord analyzes the heart of the matter. (See Proverbs 16:2.) 📖

One can boast about being a good person, but the Lord knows the secrets of our hearts and truly understands our behaviors. When Samuel went to anoint a king over Israel, he almost picked the wrong one because the young men he examined looked so good and wise. However, the Lord told him to pass by the obvious choices and choose the one He chose according to his heart. The one He chose not only had a heart after God, but Samuel also knew the Lord well enough to know He saw into David's soul. David raised his son Solomon to understand that God rewards people according to what He sees in their hearts. (See I Kings 8:39.) 

Abimelech looked like he had evil intentions against Abraham and Sarah, for he had taken the woman with the intention of Sarah becoming his wife. While this looked quite wrong from the outside, the truth was Abraham had not told the king the truth; that Sarah was his own wife. The Lord told Abimelech, "I know that thou didst this in the integrity of thy heart" (Genesis 20:6, KJV).  While those who make up stories to cover their sin will not be blessed, the Lord understands when we innocently get into a mess. Regardless of what others think, it is a reassuring feeling to know the Lord is aware of the truth, seeing not only our thoughts but our intentions.

God knows the details of our lives. Not only does the Lord know us in every detail, He also knows every detail about what goes on around us. God's omniscience gives us hope because He knows our needs before we even ask Him. (See Matthew 6:8.)  When an outcast servant faced a distressing situation in the wilderness, she discovered the Lord had been looking out for her and her child. Hagar became the first person in Scripture to ascribe a title to the Lord (El-Roi) when she said, "You are the God who sees me" (Genesis 16:13, NIV).  What a comfort to know the Lord is watching over us even when life leaves us feeling outcast and rejected.

 **Can you tell of a preached sermon you heard that encouraged you during a time when you felt rejected?**

Joy must have flooded Mary's heart when she heard the shepherds tell of the angels' announcement. Not only did the Lord know where she was in little Bethlehem, but He sent an angel host to celebrate the birth. While thinking of how loving the Lord above must be to watch over her, Mary wrapped her arms around Him and rocked Him to sleep.

It was not too long after Jesus' birth that Mary and Joseph had to flee to the neighboring country of Egypt to get away from wicked King Herod, who wanted to kill the Child. That situation brings to mind another event involving oppression from a cruel enemy. The people of Israel suffered slavery for hundreds of years. When they cried out to the Lord, He heard them and was aware not only of their bondage but also of whom He would send as their rescuer. He told Moses exactly how he was to proceed with getting the people out of Egypt and how the Pharaoh would respond to his efforts. Once again, the Lord knew the whole story—even the part that had not happened yet. He knows your story, too.



LESSON BIG IDEA: Since God knows everything, the troubles that arise in your life will not take Him by surprise.

Finish

Reggie Jackson was a superstar ballplayer. In one particular instance, Reggie felt he should be allowed to make his own decision to steal second base. However, Earl Weaver, the manager of the Baltimore Orioles, would not allow any player to steal a base unless he got a signal to do so. Instead of waiting for the sign to steal second, Reggie went on his own. He easily made it, sliding in at second. Feeling vindicated, Reggie expected Weaver to realize he could call his own plays. Later, the manager took Reggie aside and explained to him what had actually happened on the diamond. The batter after Reggie was Lee May, one of the team's best power hitters, only behind Reggie Jackson himself. After Jackson stole second, the pitcher intentionally walked May, placing him on first base and literally taking the bat out of May's hands. When the next batter did not perform well, Weaver sent in a pinch hitter to hopefully drive the base runners home. Unfortunately, this left the team without bench strength later in the game. (Thomas Boswell, *How Life Imitates the World Series*)

Like Jackson, many people assess things from their own perspectives and make decisions without seeking the Lord, their Manager. He sees more than we do and has the big picture in mind. If we want to win in this "game," we have to look for His cues and take our signals from God's Word, not our own experience. Jackson was a star, but he could not see the big picture alone. No matter how long a person has served the Lord, he or she must continually rely on the One who knows all things when making any decisions. Fortunately, we are on the winning team.

Jesus gave us the good news that our giving, fasting, and praying are all seen and rewarded by the One who sees in secret. He not only sees what good we do discretely, but He also sees our motives in doing these things. The Lord does not just privately bless us; He makes a big deal about us and rewards us openly where everyone can see.

Because the Lord sees and knows all things, we do not have to fear.   Since He knows all things, we do not have to feel alone or forgotten. He has our storms and chaos all in view, and He sees the big picture we cannot see.

Small Group Leader's Guide

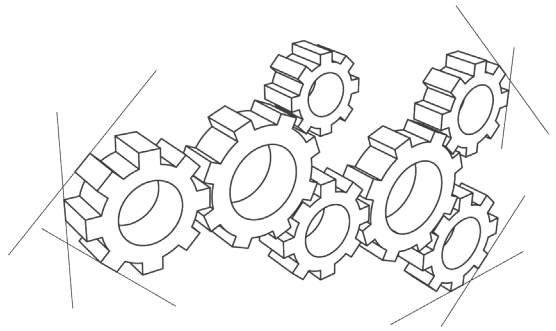

The Omni: *God Is Omniscient*

Opening Question: What is something from the future you would like to know now?

Scripture Focus: Micah 5:2

Tell the story of Ken Gaub on page 10.

Group Discussion:

- Have you ever wondered if God knew where you were and what was happening in your life? Can you give an example?
- Would you prefer to know the details of your future? Why or why not? ⚙️
- Why do you think God withholds information about our futures?
- Why do you think David wrote “Try me” when talking about his thoughts?
- What keeps us from recognizing God’s presence at times? ⚙️
- How does it make you feel to know God sees you and watches over you at all times?
- What is some evidence in your life that tells you God is working in you? ⚙️
- What has God been speaking to you about lately in regard to your relationship with Him?
- How does God normally deal with you in regard to things that need to be changed?
- What does the fact God continually watches over you say about your worth to Him ⚙️
- Is it difficult to see yourself as valuable to God? Why or why not?
- Do those who see themselves as valuable live differently than those who don’t see that value in themselves? How do they live differently?
- Why do people fear being alone? ⚙️
- What have you learned during times of feeling alone?

Prayer Focus

Lord, give me the faith to trust that You are with me even when I fail to see evidence of Your presence. I trust You and the plan You are working out in my life. Search my heart and reveal to me anything that does not please You. Cleanse me and make me clean. Thank You for watching over me every moment of my life. Thank You that I am never alone, for You are always with me.