

# 100

## PlasmaPro<sup>®</sup> 100

Etch and deposition tools for wafer processing



*The Business of Science<sup>®</sup>*



# PlasmaPro 100

Extensive process library

# PlasmaPro 100

Wide temperature range

Our extensive process library supports a wide range of applications for etch and deposition. Our processes are backed by guarantees to ensure rapid start-up during installation.

The **PlasmaPro 100** range of etch and deposition tools can be fitted with a variety of substrate electrodes, enabling processes over a wide temperature range.

Nanoscale & advanced etch	Deposition
<ul style="list-style-type: none"> <li>● Deep RIE of Silicon</li> <li>● Compound semiconductor</li> <li>● Metals</li> <li>● Oxides</li> <li>● Organic materials</li> </ul>	<ul style="list-style-type: none"> <li>● Dielectric materials</li> <li>● Metal Nitrides</li> <li>● Metal Oxides</li> <li>● DLC</li> </ul>

For our full range of processes visit: [www.oxinst.com/plasma](http://www.oxinst.com/plasma)

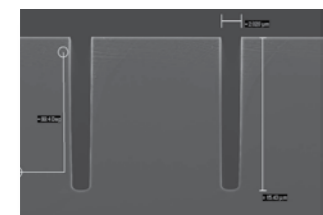

Ultra high selectivity cryo-silicon etch

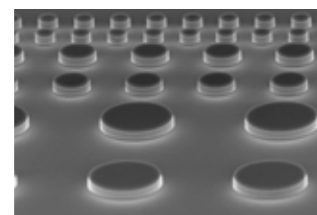

GaAs/AlGaAs multilayer etch



Deep Silicon Bosch etch

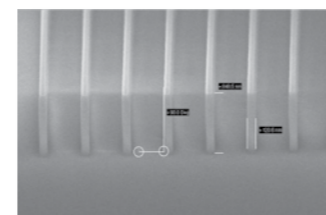

High aspect ratio high quality nanoscale SiO<sub>2</sub> etch

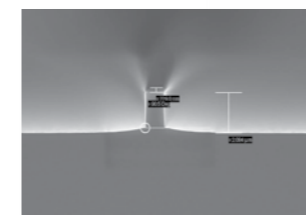

Un-clamped InP etching (Cl,Ar/In<sub>2</sub>)

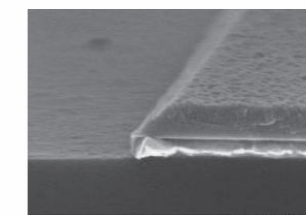

Redeposition-free hot chemical gold etch

## Etching

Two electrodes are available for etching:

- A wide temperature range electrode (-150°C to +400°C) which can be cooled by liquid nitrogen, a fluid re-circulating chiller or resistively heated. An optional blow out and fluid exchange unit can automate the process of switching modes
- A fluid controlled electrode fed by a re-circulating chiller unit

## Electrode Options

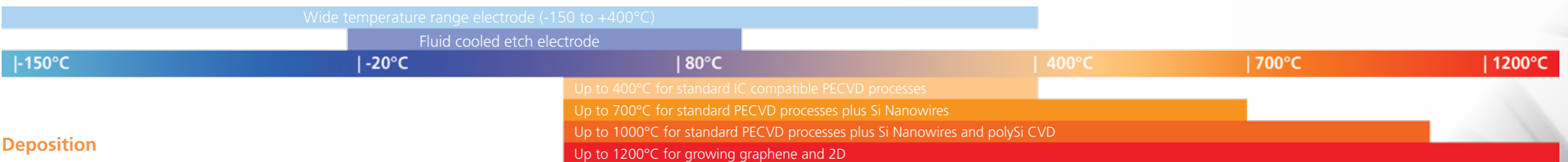

## Deposition

Two electrodes are available for deposition:

- The ICP CVD tool electrode gives high quality films from room temperature to 400°C
- PECVD tools can be fitted with resistive heated electrodes with capability up to 400°C or 1200°C

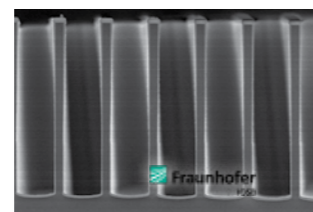

ICP CVD TEOS SiO<sub>2</sub> at <100°C

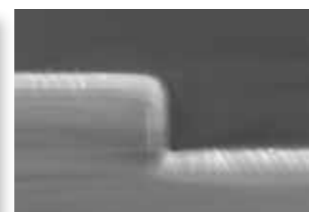

Low stress SiN film (400nm)



High rate SiO<sub>2</sub> PECVD



Aligned ZnO nanorods. Courtesy Uni Cambridge

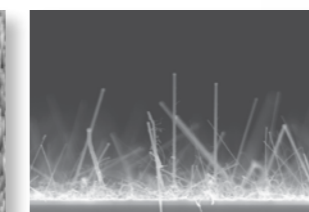

Si nanowires using Au NP as catalyst

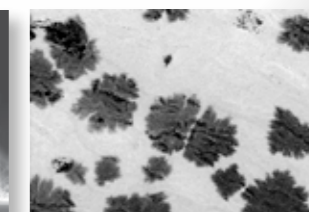

Graphene grown on Cu foil substrates

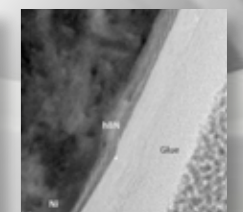

2D Boron Nitride substrates

# PlasmaPro 100

Flexible process modules for plasma etch & deposition

Oxford Instruments' **PlasmaPro 100** process modules offer a 200mm platform with single wafer and multi-wafer batch capability. The process modules offer excellent uniformity, high throughput and high precision processes.

Our tools are well proven, with over 90% uptime and processes that are guaranteed to ensure rapid start-up during installation. The **PlasmaPro 100** range supports a number of markets including but not limited to; MEMS & Sensors, Optoelectronics, Discrete Devices and Nanotechnology. It is flexible enough to be used in research and development, with the build quality to satisfy production needs.

**PlasmaPro 100** platforms may be clustered to combine technologies and processes with either cassette or single wafer loading options

- Compatible with all wafer sizes up to 200mm
- Rapid change between wafer sizes
- Global customer support network
- Low cost of ownership and ease of serviceability
- Compact footprint, flexible layout
- CE marked, safety compliant to EN 13849-1



Cassette or single wafer loading options



Optoelectronics



MEMS, BioMEMS & Sensors

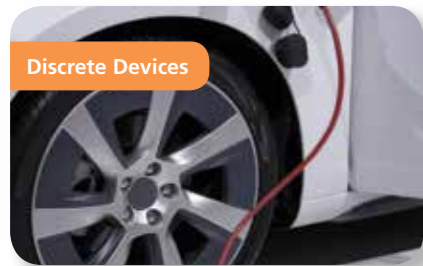

Discrete Devices



Nanotechnology

# Process Tool Software

PC4500

Oxford Instruments **PC4500** software is renowned for its clarity and ease of use, making it quick to train process operators while retaining full functionality for users.

### Software features:

- The front end visual interface is configured exactly for your system
- Control a tool cluster from a single interface and PC
- Process recipes are written, stored and recalled through the same software, building a library
- Password controlled user login allows different levels of user access and tasks, from 'one-button' run operation to full system functions
- Advanced Graphical Log Viewer:
  - Continuous system data logging ensures traceability of each wafer and process run
  - Quickly graph parameters from multiple runs on one or more graphs
  - Save graph of a "gold standard" run to easily compare against data from subsequent runs
  - Quick scroll and zoom graph axes

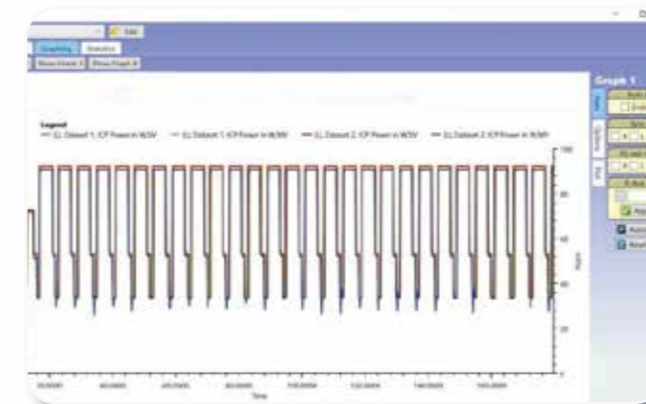
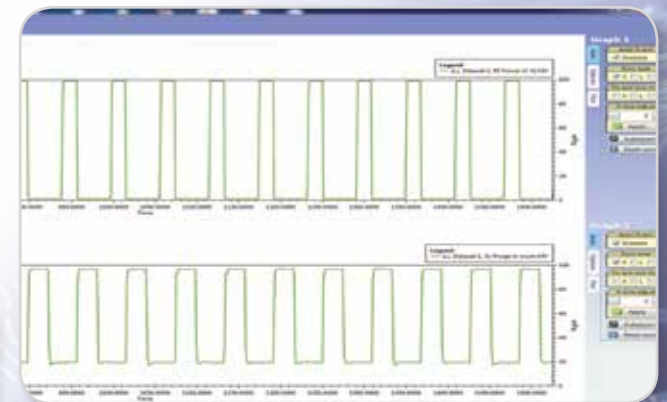
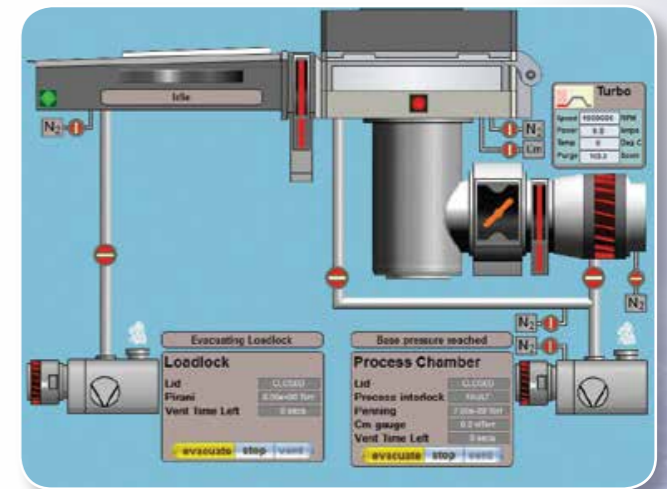

# Etch Process Modules

## Inductively Coupled Plasma Etching (ICP)

The **Cobra**® ICP etch sources produce a high density of reactive species at low pressure. Substrate DC bias is independently controlled by an RF generator, allowing control of ion energy according to process requirements.

### Cobra ICP etch features:

- Delivers reactive species to the substrate, with a uniform high conductance path through the chamber, allowing a high gas flow to be used while maintaining low pressure
- Electrodes available for temperatures from -150°C to +400°C with helium backside cooling and a range mechanical clamp designs
- Optimised hardware and control to deliver processes requiring fast process step switching, e.g. Bosch
- Variable height electrode can utilise the 3-dimensional characteristics of the plasma and accommodate substrates up to 10mm thick at optimum height

### Options:

- Electrostatic shielding delivers reduced capacitive coupling resulting in low damage at the wafer
- Chamber wall heating and liners reduce cleaning requirements and increase uptime
- Active spacer on **Cobra300** source controls ion uniformity at the wafer

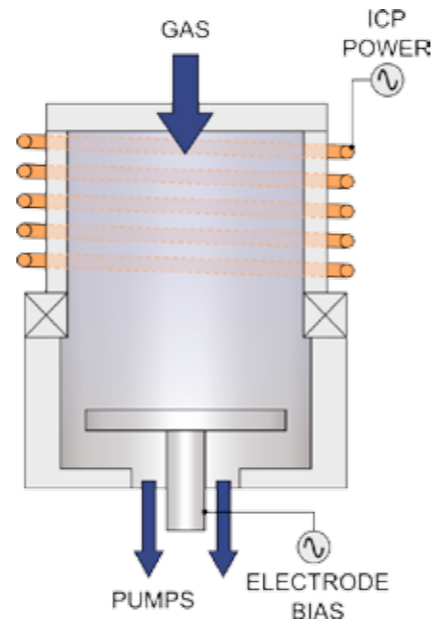

*Cobra ICP etch process chamber: 65mm, 180mm and 300mm etch sources available to suit wafer size and radical to ion ratio to suit process requirements*

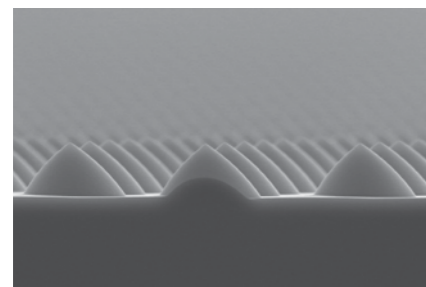

Sapphire etch - LEDs

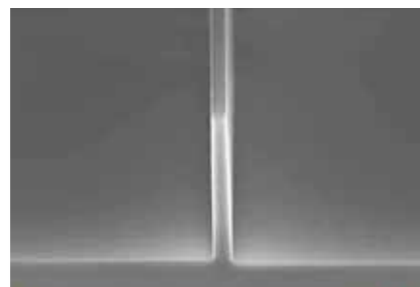

Cryogenic Si etch

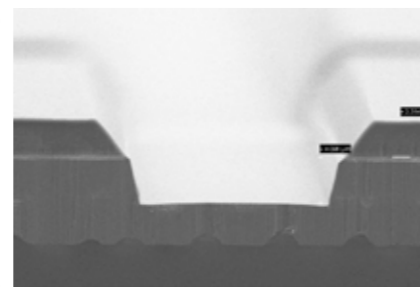

GaN etch

# Etch Process Modules

## Reactive Ion Etching (RIE)

The RIE modules deliver anisotropic dry etching for an extensive range of processes.

### RIE features:

- Solid state RF generators and close coupled matching network for fast and consistent etching
- Full area process gas inlet showerhead for uniform gas distribution
- Electrodes for temperatures from -150°C to +400°C
- High pumping capacity gives wide process pressure window
- Wafer clamping with He backside cooling is available for optimum wafer temperature control

### Options:

- Chamber wall heating and liners reduce cleaning requirements and increase uptime

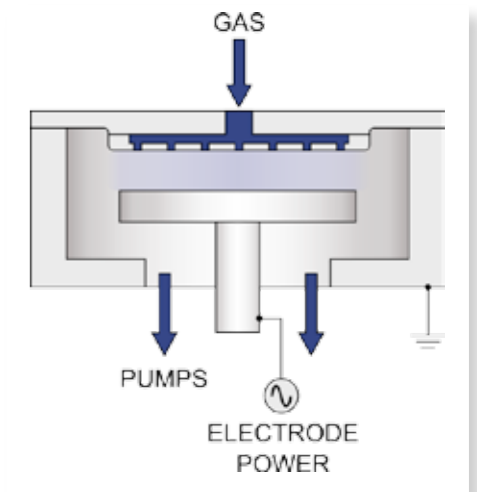

*RIE process chamber*

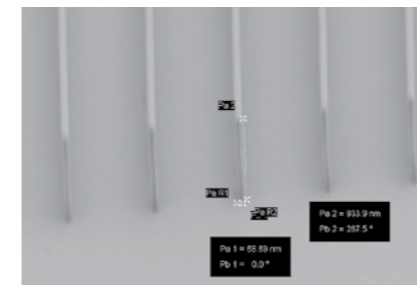

*70nm Fused Silica lines. 933nm deep Cr mask. Courtesy of Cornell Nanoscience facility*

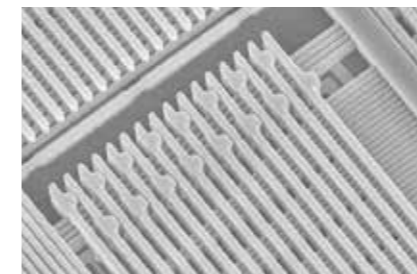

*Dielectric and metal etch – Failure analysis. Courtesy of Atmel*



# Deposition Process Modules

## Inductively Coupled Plasma Chemical Vapour Deposition (ICP CVD)

The ICP CVD process module is designed to produce high quality films with high density plasmas at low deposition pressures and temperatures.

### ICP CVD features:

- Excellent quality low damage films at reduced temperatures. Typical materials deposited include  $\text{SiO}_2$ ,  $\text{Si}_3\text{N}_4$  and  $\text{SiON}$ , Si and SiC at substrate temperatures as low as  $5^\circ\text{C}$
- ICP source sizes of 65mm, 180mm, 300mm delivering process uniformity up to 200mm wafers
- Electrodes available for temperature ranges from  $5^\circ\text{C}$  to  $400^\circ\text{C}$
- Patented ICP CVD gas distribution technology
- In situ chamber cleaning with end-pointing

### Options:

- Wall heating reduces chamber wall deposition
- Helium backside cooling with mechanical clamping ensures uniform wafer temperatures & optimised film properties

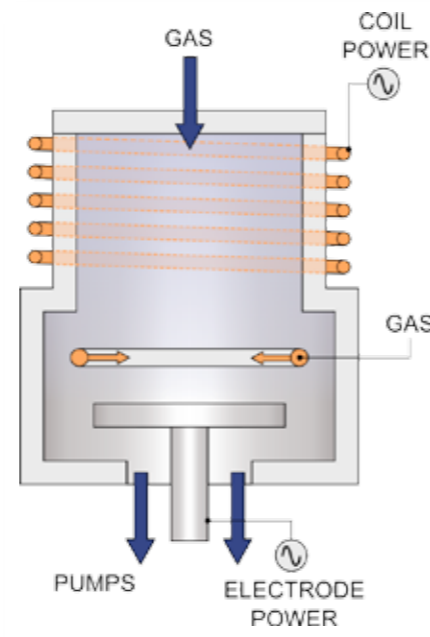

ICP CVD process chamber

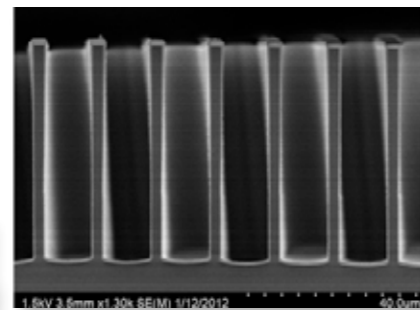

$\text{SiO}_2$  deposited using TEOS and  $\text{O}_2$  by ICP CVD in  $\sim 50\mu\text{m}$  deep trench 4:1 aspect ratio

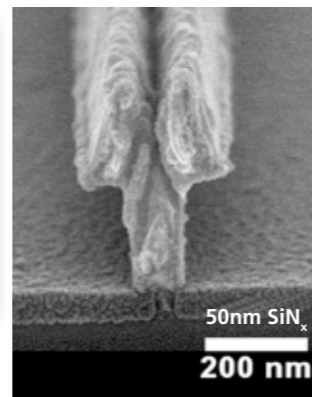

$\text{SiN}_x$  deposited by ICP CVD at room temperature for 22nm T-gate HEMT

# Deposition Process Modules

## Plasma Enhanced Chemical Vapour Deposition (PECVD)

The PECVD process modules are specifically designed to produce excellent uniformity and high rate films, with control of film properties such as refractive index, stress, electrical characteristics and wet chemical etch rate.

### PECVD features:

- In-situ chamber cleaning and end-pointing
- Electrically grounded lower electrodes available:
  - $400^\circ\text{C}$  electrode - typical processes are  $\text{SiO}_2$ ,  $\text{Si}_3\text{N}_4$  and  $\text{SiON}$ , amorphous Si and SiC
  - $1200^\circ\text{C}$  electrode - in addition to processes above, the electrode enables Si Nanowires, high temperature PECVD films with a wide variety of chemistries
- An optimised upper electrode design, operating in high pressure, high RF power, high flow regimes, enables  $\text{SiO}_2$ ,  $\text{Si}_3\text{N}_4$  and  $\text{SiON}$ , amorphous Si deposition at increased rates whilst maintaining excellent film properties and uniformity across the wafer

### Options:

- Flexible liquid source delivery module with capacity for up to 3 precursors delivered by:
  - Vapour pressure regulated by heated vapour mass flow controller
  - or Bubbled using argon
- The module is capable of delivering a wide range of precursors including:
  - TEOS, TMA, TMB, TMP, ...

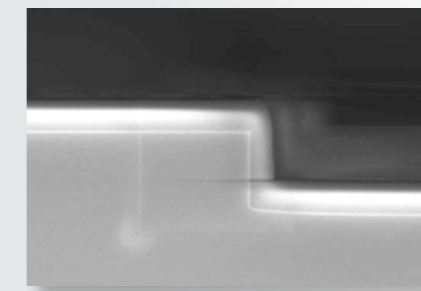

$\text{SiO}_2$  deposited using TEOS and  $\text{O}_2$  plasma gives excellent conformality

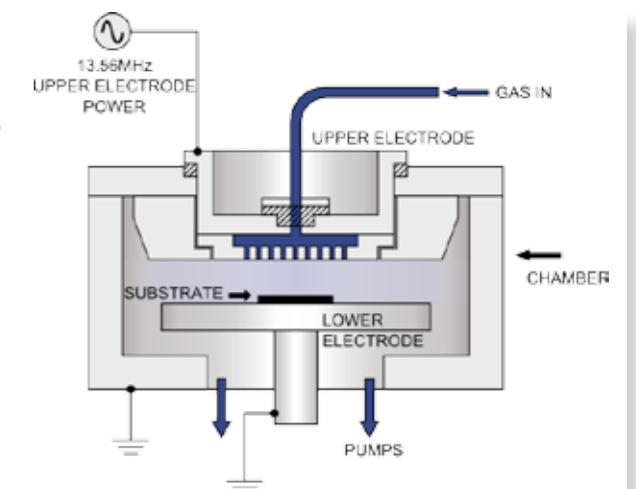

PECVD process chamber

- RF powered showerhead with optimised gas delivery, provides uniform plasma processing with LF/RF switching allowing precise control of film stress



# Process Control Options

Versatile solutions in etch and deposition

## Laser interferometry

- Allows 'etch-to-depth' within a layer
- Precise etch depth control within multi-layer structures
- Allows end pointing on small samples or those that do not provide a strong OES endpoint



Image allows positioning of laser spot

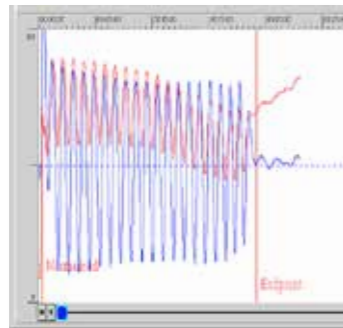

Example laser interferometry endpoint traces

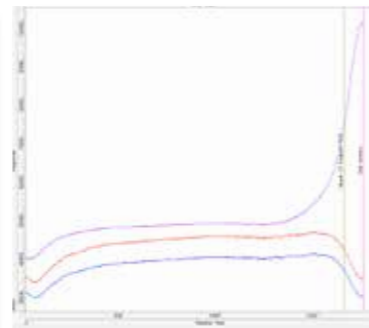

Example OES endpoint traces

## Optical emission spectroscopy (OES)

- Allows a precise stop on a particular layer, improving throughput and yield
- Ideal for full wafer or batch end pointing
- Enables monitoring of chamber condition and process 'health'
- Recommended for end pointing of PECVD chamber cleans

# Serviceability

Layout options

## Highly configurable, flexible systems

The **PlasmaPro 100** Systems are designed to be installed in ballroom, through the wall or to the wall configuration.

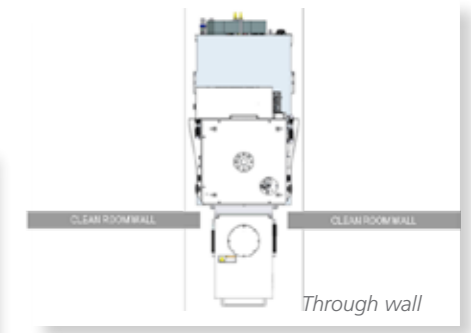
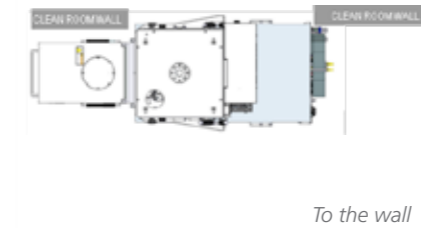

## Cluster Options

Platforms may be clustered to combine technologies and processes with either cassette or single wafer loading options. Hexagonal or square transfer chamber configurations are available.

### 4-way square handler

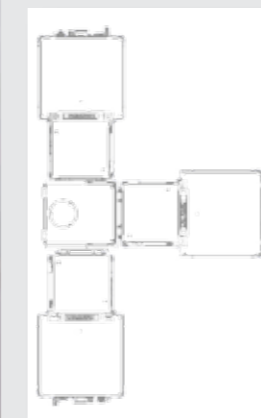

### Brooks MMX cluster

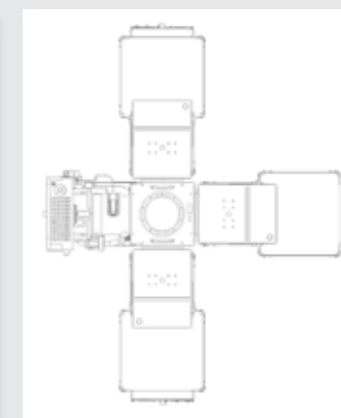

### 6-way hex handler

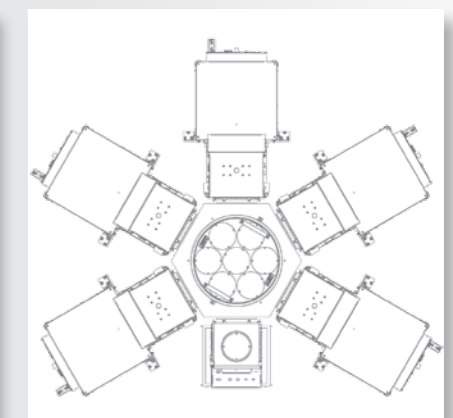

## Gas Control System

A modular upgrade path for gas lines enables users to maximise flexibility of the **PlasmaPro 100**. The remote gas line by-pass facility allows broad functionality & ease of use.

- The design enables the easy addition of further gas lines, up to a maximum of 12
- Optional purge facility
- Heated lines with temperature control
- The gas pod may be sited remotely in a service area or mounted on the process module frame. It is vented and ready for ducting into an extraction system for full safety compliance



# Global Service and Support

For further information about our **PlasmaPro 100** range, please contact your local Oxford Instruments Office

## Excellent serviceability & low cost of ownership

The flexible configuration provides ease of access to all aspects of the tool ensuring excellent serviceability and low cost of ownership.

## Superior environmental efficiency

**PlasmaPro 100** has a low heat load and high energy efficiency. The tool has efficient ergonomics and complies with Semi S2/S8 and cluster capability, making this a tool of choice for production users.

## Customer support & training

Our range of service level agreements will be tailored to your needs:

- Choice of support coverage up to 24/7
- Scheduled preventative maintenance calls
- Managed spares inventory options
- Preferential spare part pricing
- Process & user maintenance training
- Guaranteed response times for support engineer visits and technical hotline calls



Visit [www.oxford-instruments.com/plasma](http://www.oxford-instruments.com/plasma)

### Oxford Instruments Plasma Technology

For more information please email:  
[plasma@oxinst.com](mailto:plasma@oxinst.com)

#### UK

Yatton  
Tel: +44 (0) 1934 837000

#### Germany

Wiesbaden  
Tel: +49 (0) 6122 937 161

#### India

Mumbai  
Tel: +91 22 4253 5100

#### Japan

Tokyo  
Tel: +81 3 5245 3261

#### PR China

Beijing  
Tel: +86 10 6518 8160/1/2  
Shanghai  
Tel: +86 21 6132 9688

#### Singapore

Tel: +65 6337 6848

#### Taiwan

Tel: +886 3 5788696

#### US, Canada & Latin America

Concord, MA  
TOLLFREE: +1 800 447 4717

[www.oxford-instruments.com](http://www.oxford-instruments.com)

This publication is the copyright of Oxford Instruments Nanotechnology Tools Ltd and provides outline information only, which (unless agreed by the company in writing) may not be used, applied or reproduced for any purpose or form part of any order or contract or regarded as the representation relating to the products or services concerned. Oxford Instruments' policy is one of continued improvement. The company reserves the right to alter without notice the specification, design or conditions of supply of any product or service. Oxford Instruments acknowledges all trademarks and registrations. © Oxford Instruments Nanotechnology Tools Ltd, 2017. All rights reserved. Ref: OIPT/100/2017/001



*The Business of Science®*