

KSL8250 -WH

LED Round Step Light | DIA 2" | 120 LM
WH | 5000 K | 2W DOB | DC 12 V

KSL8250 - WH

Specification

Product Name :	KSL8250 - WH
Product Series :	LED Round Step Light
Product Description :	Aluminium housing, white finish, CR180, 5000K, 2W DOB, DC 12V with pre-installed clip, extra spring on the side
Size :	1-7/8" DIA x 7/8" D
LED Chip :	2835 LED Chips
Input Voltage :	12V, 60Hz
Input Current :	0.17A
Rated Power Input :	2W
Rated Power Factor :	>0.95
THD :	<20%
Ra :	Ra ≥ 80
CCT :	5000 K
Delivered Lumen :	120 LM
Luminaire Efficacy :	60 lm/w
IP Rated :	IP 44
Life Hour :	5 years
Dimmable :	Non
Certificate :	ETL & CETL
Range of Application :	Damp Locations
Body Color :	White
Body Material :	Aluminium
Lens Color :	White
Lens Material :	Plastic

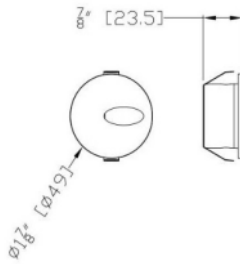
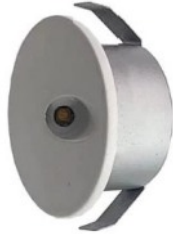

LUMINOUS INTENSITY DISTRIBUTION DIAGRAM

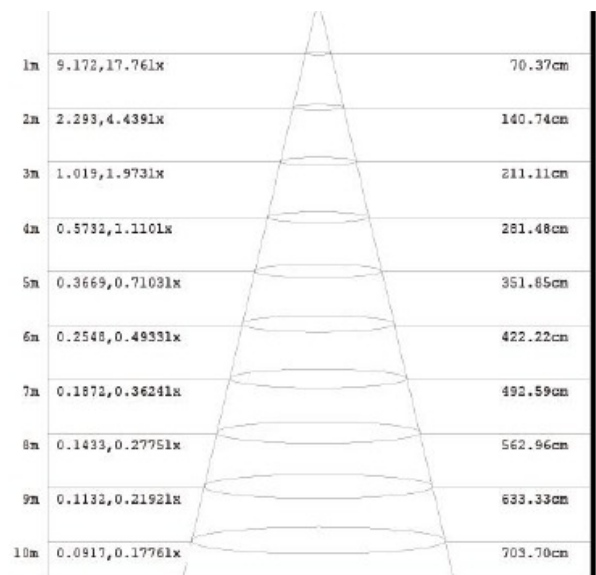
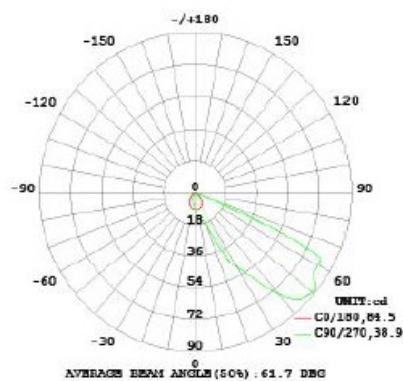

KSL8230 - WH

LED Round Step Light | DIA 2" | 120 LM
WH | 3000 K | 2W DOB | DC 12 V

KSL8230 - WH

Specification

Product Name :	KSL8230 - WH
Product Series :	LED Round Step Light
Product Description :	Aluminium housing, white finish, CRI80, 3000K, 2W DOB, DC 12V with pre-installed clip, extra spring on the side
Size :	1-7/8" DIA x 7/8" D
LED Chip :	2835 LED Chips
Input Voltage :	12V, 60Hz
Input Current :	0.17A
Rated Power Input :	2W
Rated Power Factor :	Deliver
THD :	ed
Ra :	Lumen
CCT :	:
Luminaire Efficacy :	60 lm/w
IP Rated :	IP 44
Life Hour :	5 years
Dimmable :	Non
Certificate :	ETL & CETL
Range of Application :	Damp Locations
Body Color :	White
Body Material :	Aluminium
Lens Color :	White
Lens Material :	Plastic

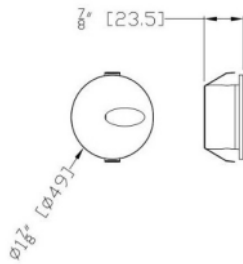

LUMINOUS INTENSITY DISTRIBUTION DIAGRAM

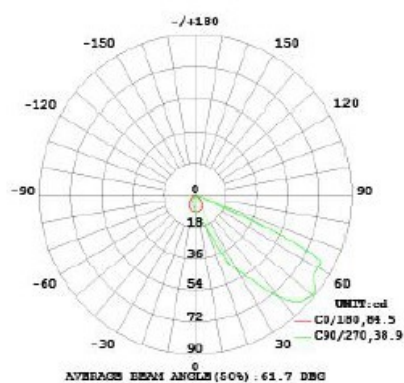

1m	9.172, 17.761x	70.37cm
2m	2.293, 4.4391x	140.74cm
3m	1.019, 1.9731x	211.11cm
4m	0.5732, 1.1101x	281.48cm
5m	0.3669, 0.71031x	351.85cm
6m	0.2548, 0.49331x	422.22cm
7m	0.1872, 0.36241x	492.59cm
8m	0.1433, 0.27751x	562.96cm
9m	0.1132, 0.21921x	633.33cm
10m	0.0917, 0.17761x	703.70cm



KSL8250 -BK

LED Round Step Light | DIA 2" | 120 LM
WH | 5000 K | 2W DOB | DC 12 V

KSL8250 - BK

Specification

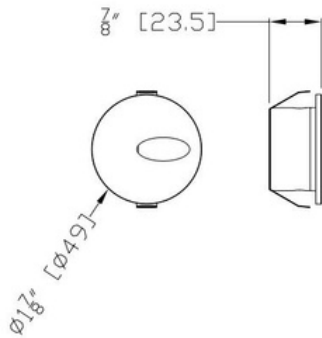

Product Name :	KSL8250 - BK
Product Series :	LED Round Step Light
Product Description :	Aluminium housing, black finish, CR180, 5000K, 2W DOB, DC 12V with pre-installed clip, extra spring on the side
Size :	1-7/8" DIA x 7/8" D
LED Chip :	2835 LED Chips
Input Voltage :	12V, 60Hz
Input Current :	0.17A
Rated Power Input :	2W
Rated Power Factor :	Deliver
THD :	ed
Ra :	Lumen
CCT :	:
Luminaire Efficacy :	60 lm/w
IP Rated :	IP 44
Life Hour :	5 years
Dimmable :	Non
Certificate :	ETL & CETL
Range of Application :	Damp Locations
Body Color :	White
Body Material :	Aluminium
Lens Color :	White
Lens Material :	Plastic

LUMINOUS INTENSITY DISTRIBUTION DIAGRAM

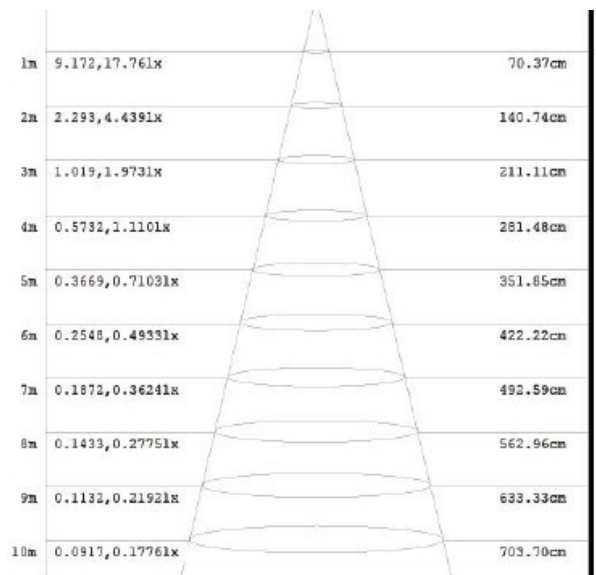
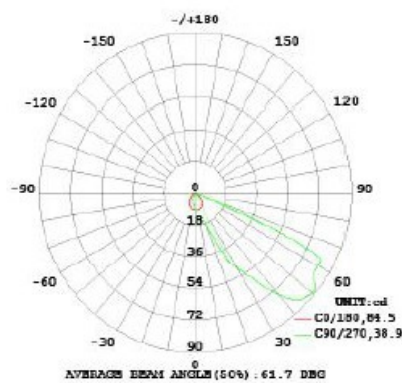

KSL8230 - BK

LED Round Step Light | DIA 2" | 120 LM
BK | 3000 K | 2W DOB | DC 12 V

KSL8230 - BK

Specification



Product Name :	KSL8230 - BK
Product Series :	LED Round Step Light
Product Description :	Aluminium housing, black finish, CRI80, 3000K, 2W DOB, DC 12V with pre-installed clip, extra spring on the side
Size :	1-7/8"DIA x 7/8"D
LED Chip :	2835 LED Chips
Input Voltage :	12V, 60Hz
Input Current :	0.17A
Rated Power Input :	2W
Rated Power Factor :	>0.95
THD :	<20%
Ra :	Ra ≥ 80
CCT :	3000 K
Delivered Lumen :	120 LM
Luminaire Efficacy :	60 lm/w
IP Rated :	IP 44
Life Hour :	5 years
Dimmable :	Non
Certificate :	ETL & CETL
Range of Application :	Damp Locations
Body Color :	Black
Body Material :	Aluminium
Lens Color :	White
Lens Material :	Plastic

LUMINOUS INTENSITY DISTRIBUTION DIAGRAM

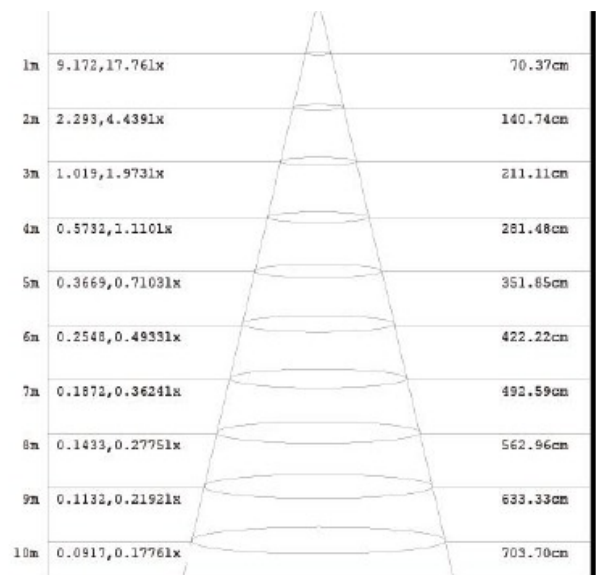
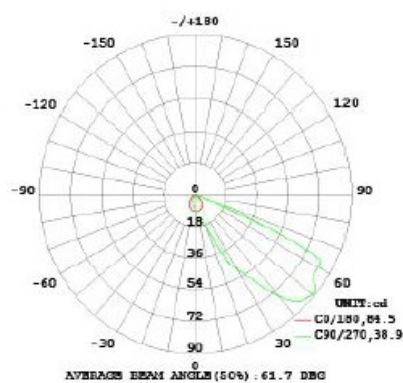

KSL8250 -SN

LED Round Step Light | DIA 2" | 120 LM
SN | 5000 K | 2W DOB | DC 12 V

KSL8250 - SN

Specification



Product Name :	KSL8250 - SN
Product Series :	LED Round Step Light
Product Description :	Aluminium housing, Brushed nickel finish, CRI80, 5000K, 2W DOB, DC 12V with pre-installed clip, extra spring on the side
Size :	1-7/8" DIA x 7/8" D
LED Chip :	2835 LED Chips
Input Voltage :	12V, 60Hz
Input Current :	0.17A
Rated Power Input :	2W
Rated Power Factor :	>0.95
THD :	<20%
Ra :	Ra ≥ 80
CCT :	5000 K
Delivered Lumen :	120 LM
Luminaire Efficacy :	60 lm/w
IP Rated :	Ip44
Life Hour :	5 years
Dimmable :	Non
Certificate :	ETL & CETL
Range of Application :	Damp Locations
Body Color :	Brushed Nickel
Body Material :	Aluminium
Lens Color :	White
Lens Material :	Plastic

LUMINOUS INTENSITY DISTRIBUTION DIAGRAM

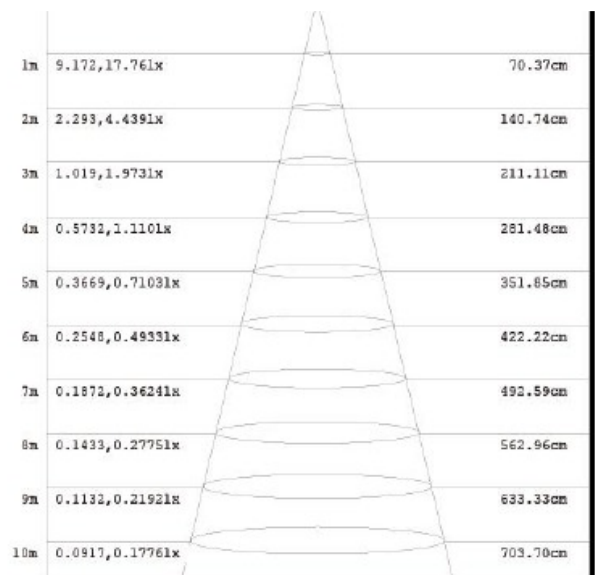
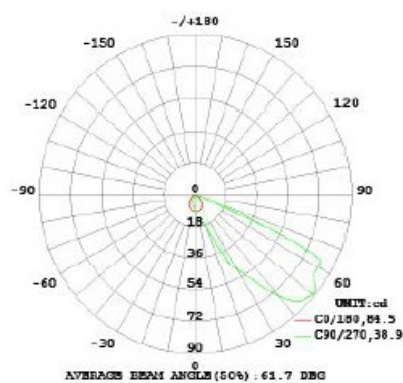

KSL8230 -SN

LED Round Step Light | DIA 2" | 120 LM
SN | 3000 K | 2W DOB | DC 12 V

KSL8230 - SN

Specification



Product Name :	KSL8230 - SN
Product Series :	LED Round Step Light
Product Description :	Aluminium housing, Brushed nickel finish, CRI80, 3000K, 2W DOB, DC 12V with pre-installed clip, extra spring on the side
Size :	1-7/8" DIA x 7/8" D
LED Chip :	2835 LED Chips
Input Voltage :	12V, 60Hz
Input Current :	0.17A
Rated Power Input :	2W
Rated Power Factor :	>0.95
THD :	<20%
Ra :	Ra ≥ 80
CCT :	3000 K
Delivered Lumen :	120 LM
Luminaire Efficacy :	60 lm/w
IP Rated :	Ip44
Life Hour :	5 years
Dimmable :	Non
Certificate :	ETL & CETL
Range of Application :	Damp Locations
Body Color :	Brushed Nickel
Body Material :	Aluminium
Lens Color :	White
Lens Material :	Plastic

LUMINOUS INTENSITY DISTRIBUTION DIAGRAM

