

# X-SENSE

## Hardwired Combination Smoke and Carbon Monoxide Alarm with Battery Backup



X-Sense Innovations Co., Ltd.  
Email: [support@x-sense.com](mailto:support@x-sense.com)

## User Manual

Model: XP04/XP05/XP06

## Table of Contents

Introduction .....	1
Product View .....	1
Location and Placement .....	3
Location in Your Home .....	3
Placement on a Wall or Ceiling .....	4
Mobile Home Installation .....	5
Installation .....	6
Operating Instructions .....	11
What to Do When an Alarm Sounds .....	11
Using the Silence Function .....	12
Smoke/CO Alarm Reminder .....	13
Device Status Checklist .....	14
Technical Specifications .....	16
Maintenance .....	17
Weekly Test .....	17
Battery Replacement .....	17
Troubleshooting .....	18
Safety .....	19
General Safety Information .....	19
Smoke Alarm .....	20
CO Alarm .....	21
Electrical Shock Hazard .....	22
FCC Compliance .....	23
Environmental Protection .....	24
Manufacturer and Service Information .....	24

## Introduction

Thank you for purchasing this X-Sense hardwired combination smoke and carbon monoxide alarm. This user manual contains important information about your alarm installation and operation. Please read this manual carefully and save it for future reference.

This X-Sense hardwired combination smoke and carbon monoxide alarm is intended for detecting both smoke and carbon monoxide in a residential environment. It has a photoelectric sensor to detect large particles produced by smoldering fires, and an electrochemical sensor to detect dangerous levels of carbon monoxide, protecting your family from two deadly household threats in one unit.

This device is powered via your home's electrical system and is also equipped with a backup battery in case the electricity fails. It complies with regulatory requirements, including UL 217 and UL 2034 Standards, and should be installed by a qualified technician. All installed wiring should conform to articles 210, and 300.3B of the National Electrical Code ANSI/ NFPA 70, NFPA 72, and/or applicable codes in your local jurisdiction.

This device can work either as a single unit or be interconnected with other X-Sense AC and AC/DC alarms. Under AC power, all devices will alarm when any single device senses smoke or CO. If the electricity fails, only the AC/DC devices will continue to send and receive signals within the interconnected alarm network, while AC-only devices will cease to operate. Note that AC hardwired interconnection only works for X-Sense XP04, XP05, XP06, XP04-S, XP05-S, and XP06-S devices.

## Product View

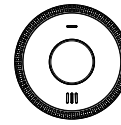

Unit x 1

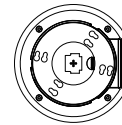

Mounting Bracket x 1



Anti-dust Cover x 1



Screw x 4

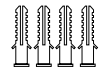

Anchor Plug x 4



Power Connector x 1



9V Battery x 1



User Manual x 1



Warning Sticker x 2

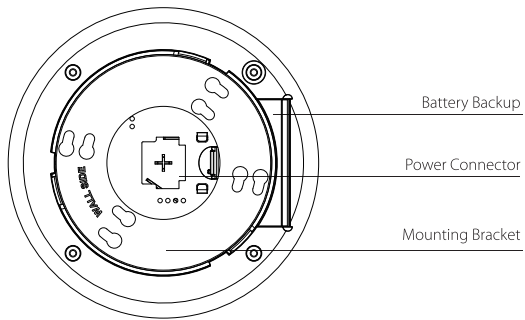
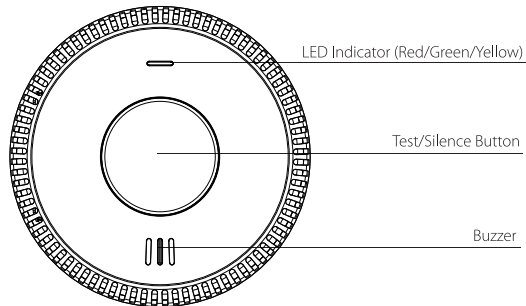

### LED Indicator

The LED indicator flashes to indicate device status, which includes powering on, standby mode, smoke alarm, CO alarm, alarm exit, device test, silence function, low battery, malfunction, and end-of-life signal.

### Test/Silence Button

The Test/Silence button is used to check if your alarm is still properly functioning and to temporarily silence an alarm.

### Buzzer

The buzzer will beep in sync with the LED indicator to indicate device status, which includes powering on, smoke/CO alarm, device test, low battery, malfunction, and end-of-life signal.

### Battery Backup

During power outages, the backup battery will activate to ensure continuous power supply. Note that this battery is replaceable.

### Power Connector

The power connector is used to plug into the device's power receptacle on the device and supplies the device with AC power. The black line is "hot", the white line is "neutral", and the red line is used for interconnection.

### Mounting Bracket

The mounting bracket is supplied for device installation. Twist counterclockwise to remove from the device before mounting.

## Location and Placement





All connections should be made by a professional technician, and all wiring should comply with articles 210 and 300.3 (B) of the U.S. National Electrical Code ANSI/NFPA 70, NFPA 72, and/or any other codes having jurisdiction in your area.

### Location in Your Home

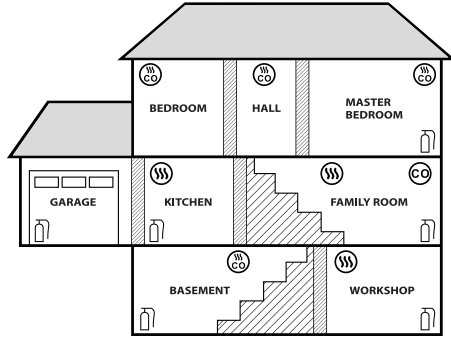
In accordance with NFPA recommendations, it is recommended to install an X-Sense smoke and carbon monoxide alarm:

- On every level of your home, including finished attics and basements.
- Inside every bedroom or adjacent hallway to every sleeping area. If a room or hallway is longer than 40 feet (12 m), install a device at each end.
- In every room containing a fuel-burning appliance.
- In all rooms, hallways, and storage areas where the temperature is usually between 40–100°F (4.4–37.8°C).



-  FIRE EXTINGUISHERS
-  SMOKE ALARMS
-  CARBON MONOXIDE ALARMS
-  SMOKE & CO ALARMS

### Placement on a Wall or Ceiling

It is recommended that you install an alarm on the ceiling so that it can detect the first traces of smoke when smoke rises. However, regardless of where you install it, ensure that nothing can prevent smoke or CO from reaching the alarm.

If you install the device on the ceiling, center it in the room, as smoke spreads horizontally after rising to the ceiling. Make sure it is at least 20 inches (50 cm) away from the wall.

If an alarm is installed onto a wall, keep 4-12 inches (10-30 cm) below the ceiling.

If you install the alarm on a sloped ceiling, place it between 4 inches (10 cm) and 35 inches (90 cm) from the peak. Keep the device at least 5 feet (1.5 m) from potential smoke or fume sources such as stoves, furnaces, water heaters, and space heaters.

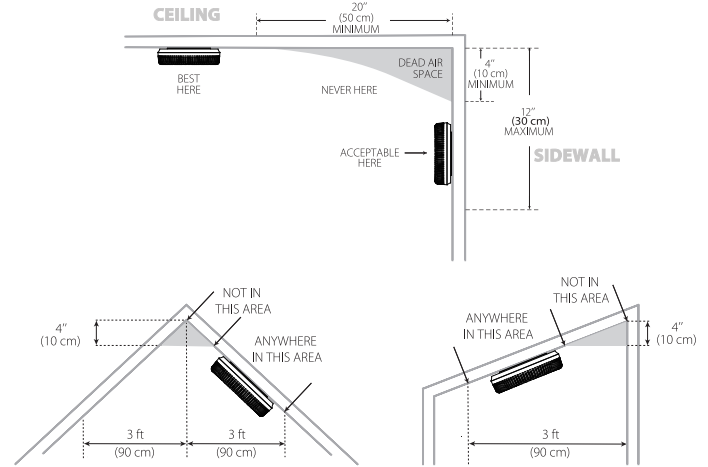

### Mobile Home Installation

In mobile homes or older houses, extreme heat and cold can spread from the outside to the inside due to poorly insulated walls and roofing. This may create a thermal barrier that can prevent smoke from reaching the alarm. In this situation, install the device on an inside wall with the top edge of the device at a minimum of 4 inches (10 cm) and a maximum of 12 inches (30 cm) below the ceiling.

If you are unsure about the insulation quality of your home, install the alarm on an inside wall near the bedrooms. Test the alarm before each trip and at least once a week during use.

## Locations to Avoid

Improper location can have a negative impact on device performance and may cause false alarms. To promote accurate detection and full protection of your home, do not install this combination smoke and carbon monoxide alarm:

- In a garage or any area that is dusty, dirty, or greasy.
- In bathrooms, kitchens, garages, attics, in unheated areas, or near recessed ceiling areas, ceiling fans, furnaces, or furnace vents. Keep the alarm at least 3 feet (0.9 m) away horizontally from bathroom doors.
- Within 5 feet (1.5 m) of smoke sources, such as a stove.
- In extremely humid environments. Keep the unit at least 10 feet (3 m) away from baths, saunas, humidifiers, vaporizers, dishwashers, laundry rooms, or other sources of extreme humidity.
- In turbulent air, such as near ceiling fans, heat vents, air conditioner vents, or open windows, as excessive airflow may prevent CO from reaching the sensors.
- Under direct sunlight.
- In dead air spaces that may prevent smoke from reaching the device.
- Near cooking appliances, dusty areas, showers, or any areas where the temperature drops below 40°F (4.4°C) or rises above 100°F (37.8°C).

## Installation

This combination smoke and carbon monoxide alarm should be installed by a qualified technician, and all wiring should be in accordance with The National Fire Protection Association's Standard 72 and relevant regulations or applicable codes in your local jurisdiction. Specific requirements for this alarm vary by state and region. Check with your local Fire Department for current requirements in your area.

### Important Safety Precautions

1. Before installing the X-Sense alarms, remove all non-X-Sense alarms in the circuit, as doing so could harm the devices and cause electric shock or fire.
2. If the colors of our three wires are inconsistent with those in your circuit, please do not rely on the wire colors and connect them strictly according to the neutral wire, live wire, and signal wire.
3. After the X-Sense alarms are installed and the AC power is turned on, if all the alarms start to sound an alarm immediately, there might be a wiring issue. Please turn off the AC power and inspect the wiring of each device. If you have confirmed that all wiring is correct and secure, but the problem persists, please get in touch with our customer service for assistance.
4. If you have installed the X-Sense alarms and connected them to the AC power supply, and they have entered standby mode, proceed to press and hold the test button on one of the alarms. Confirm whether each other device emits a short sound (please ask a second person to assist with this test). If not, there might be a wiring issue. In such a situation, turn off the AC power and inspect the wiring of each device. If

*you have verified that all wiring is correct, but the problem persists, please contact customer service for further assistance.*

### WARNING

This X-Sense hardwired alarm should not be connected to any other brand of hardwired alarms, since doing so could harm the device and cause electric shock or fire.

### INSTALLATION NOTE

**DO NOT REMOVE THE DUST COVER UNTIL ALL CONSTRUCTION HAS BEEN COMPLETED FOR AT LEAST 24 HOURS** (drywall, painting, varnishing, mounting plate installation, etc).

Construction dust and chemicals can cause contamination and false alarms.

**WARNING: THE DUST COVER MUST BE REMOVED FOR THE DEVICE TO OPERATE PROPERLY.**

## 1. Get to Know Your Alarm

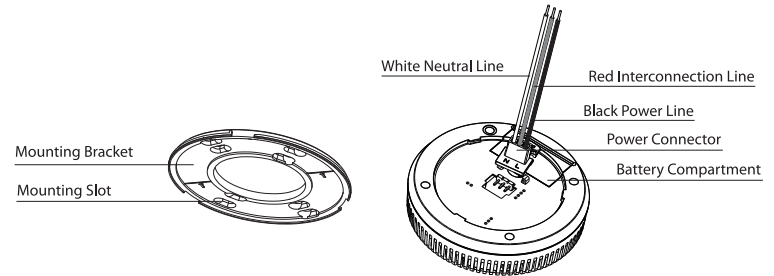

### Before Installation:

- This device should be installed on a standard 4-inch (10-cm) wiring junction box, or on any ceiling or wall allowed by local codes.
- An appropriate power source is 120 V AC Single Phase, supplied from a non-switchable circuit, which is not protected by a ground fault interrupter. If you want this unit to function as a standalone unit, keep the insulating cap on the red line to ensure that it does not connect to other units.
- If you want to create an interconnected alarm system, ensure all interconnected devices are powered by a single circuit. In accordance with NFPA restrictions, up to 24 devices can be added in a single circuit, including 18 alarms and six range extenders. A maximum of 12 smoke alarms is allowed in the 18 alarms.

- In an interconnected system, the maximum wiring distance between the first and last device should be no more than 1000 feet (305 m).
- Interconnect devices within a single-family residence only. Interconnected devices will only work if they are wired to compatible devices and all requirements are met. Note that AC hardwired interconnection only works for X-Sense XP04, XP05, XP06, XP04-S, XP05-S, and XP06-S devices.

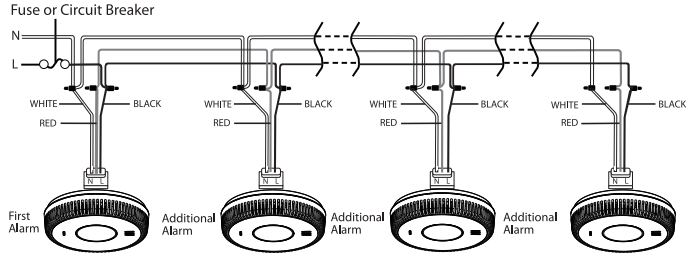

### Power Connector:

- Black Line: Hot side of AC line
- White Line: Neutral side of AC line
- Red Line: Interconnects other units for a multiple unit set-up

### 2. Turn Off Power

Before installation, turn off power to the area where this device will be installed at the circuit breaker or fuse box. Otherwise, it can result in serious electrical shock, personal injury, or even death. Do not restore power until all devices are completely installed.

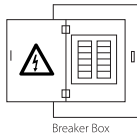

**⚠ WARNING**  
 Electrical Shock Hazard  
 Failure to turn off power may result in serious electrical shock, injury, and even death.

### 3. Remove the Old Device

If an existing alarm is not installed on the ceiling or wall, skip this step. Disconnect all cables from the old alarm, then twist and remove carefully to avoid damage to the wall or ceiling. Then, remove the old base by unscrewing the mounting plate from the electrical box.

### 4. Connect the Cables

The set of cables that come with the alarm contains three colors: black for "hot," white for "neutral," and red for "interconnection." Hold the end of the white wire together with the end of a white wire in the electrical box, cap them with a wire nut, then twist clockwise until secure. Do the same for the black and red wires.

### 5. Install the Mounting Bracket

Screw the mounting bracket to the electrical box using the provided screws.

Note:

The side marked "WALL SIDE" should face the wall.

### 6. Insert the Battery

Open the device's battery cover and take out the temporary foam insert. Then install the provided battery inside the battery compartment. Once installed properly, the alarm will activate, and the LED indicator will flash yellow, green, and red in sequence eight times.

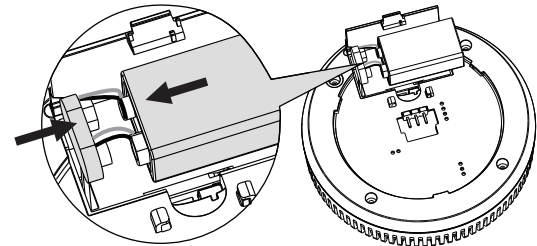

### 7. Connect the Power Connector to the Device

Plug the power connector into the back of the device, then stuff any excess wiring into the electrical box. Make sure the power connector is aligned with the back of the unit.

**Note:**

Improper wiring of the power connector may damage the unit.

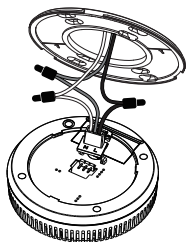

**8. Mount the Device**

Align the mounting bracket with the unit, then twist clockwise until you feel resistance. If you want the LED indicator and buzzer to be aligned with other already installed units, you may need to twist up to three times to horizontally align the unit with the wall.

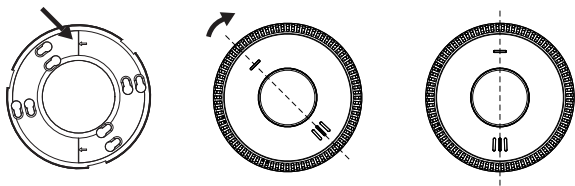

**9. Turn On Power**

If you need to install more than one device, repeat the steps above. Turn on the power after installation. When the unit receives power, the LED indicator will light up green, indicating that it is functioning properly.

**10. Test the Device**

Test the device when you turn on the unit for the first time, or when the group configuration has changed. Note that this will only test the device circuits, rather than test the smoke and CO sensors. If your device fails to emit an audible test alert, please refer to the troubleshooting section.

**To test an individual device:**

Press the Test/Silence button. The device should emit two sets of three long beeps, followed by two sets of four beeps. The LED indicator should flash red. After testing, the device will automatically return to standby mode.

**To test all interconnected devices:**

Press and hold the Test/Silence button on any device until you hear beeps. The initiating device should keep beeping with its LED indicator flashing red. Other interconnected devices should emit two sets of three long beeps with the LED indicator flashing red and green in sequence, then emit two sets of four beeps with the LED indicator flashing red.

The test will finish within three minutes, at which point all devices will return to standby mode.

**Important:**

Do not tamper with this device, as this may result in electrical shock or device malfunction.

## Operating Instructions

If something goes wrong with your alarm, it will notify you of what's going on through the colored LED indicator and beeping pattern.

**What to Do When an Alarm Sounds**

If an alarm is triggered, all other interconnected alarms will sound simultaneously with the initiating alarm. If the smoke alarm and CO alarm are both triggered at the same time, the smoke alarm will take priority over the CO alarm in terms of signaling. When an alarm sounds, the first thing to do is identify the type of alarm.

If a smoke alarm is triggered, you will hear and see:

	Initiating Device	Other Interconnected Devices
Buzzer	Three beeps every four seconds	
LED Indicator	Flashes red three times every four seconds	Flash red and green in sequence every four seconds

How to respond to a smoke alarm:

1. Locate the source of fire. If a fire is present, exit the house immediately.
2. Do not panic. Stay calm and follow your escape plan.
3. Touch doors before you open them. If the door is not hot to the touch, open it slowly. If hot, avoid it. Keep doors and windows closed unless you must escape through them.
4. Cover your nose and mouth with a cloth (preferably damp). Take short, shallow breaths.
5. Once outside, call the Fire Department as soon as possible.
6. Never re-enter a burning building for any reason.

If a CO alarm is triggered, you will hear and see:

	Initiating Device	Other Interconnected Devices
Buzzer	Four beeps every 5.8 seconds	
LED Indicator	Flashes red four times every 5.8 seconds	Flash red four times and green once every 5.8 seconds

How to respond to a CO alarm:

1. Call emergency services as soon as possible.
2. Move outside immediately for fresh air. Make sure everyone in the house has evacuated the area. Do not re-enter the house until the air in the house has had time to recirculate and your alarms return to normal working condition. If it is impossible to move outside, stay close to an open door/window until emergency personnel arrives.
3. After following steps 1–2, if your alarm alerts again within a 24-hour period, repeat steps 1–2 and call a qualified technician to investigate sources of CO from fuel-burning equipment and appliances to ensure proper operation of this equipment.
4. If problems are identified during this inspection, have the device serviced immediately. For combustion devices that have not been inspected by a technician, consult the manufacturer's instructions, or contact the manufacturer directly for more information about CO safety and this equipment. Make sure that motor vehicles are not and have not been operating in an attached garage or adjacent to the residence.

## Using the Silence Function

The silence function is only intended for temporarily silencing an alarm, not for correcting any problems. Note that you cannot silence an alarm by removing the battery from the device or disconnecting from power. Doing so will disable the unit and remove your protection.

## To silence a smoke or CO alarm:

You can temporarily silence false alarms by pressing the Test/Silence button on any device.

Smoke Alarm	CO Alarm
The silence duration for a smoke alarm is nine minutes. After that, if the smoke concentration level reaches the alarm level again, the device will alarm again.	The silence duration for a CO alarm is nine minutes, then it will exit the silence mode. However, if after six minutes, the CO concentration is still at the alarm level, the device will alarm again. If the CO concentration is at a very dangerous level higher than 300 ppm, the device cannot be silenced.

## Note:

- To silence any interconnected smoke or CO alarm, press the Test/Silence button on the source alarm. To locate the source alarm, press the Test/Silence button on any device; if all devices are silenced except for one device, then the alarm still sounding is the initiating device. You can also locate it using the colored LED indicator with a beeping pattern. The source alarm flashes red with three long beeps every four seconds if a smoke alarm is triggered. If a CO alarm is triggered, it will flash red with four beeps every 5.8 seconds.
- When you temporarily silence one device by pressing the Test/Silence button, other interconnected devices are not silenced and will sound an alarm together if they detect smoke or CO.

## To silence the low-battery warning:

If the battery level is low, the LED indicator will flash yellow once every 60 seconds, and the buzzer will beep every 60 seconds. To silence this alarm, press the Test/Silence button on the device. The device will be temporarily mute for 10 hours.

## To silence the end-of-life signal:

When the battery is weak, the LED indicator will flash yellow three times with three beeps every 60 seconds. Press the Test/Silence button to stop the end-of-life signal for 22 hours. Note that this function will only work within 30 days of the expiration date.

## Smoke/CO Alarm Reminder

The device will remind you of any smoke and CO alarm you may have missed. If a smoke alarm was triggered and then returned to standby mode after the smoke concentration decreased below the alarm level, the LED indicator will flash red and yellow sequentially once every five seconds. If a CO alarm was triggered and then returned to standby mode after the CO concentration decreased below the alarm level, the LED indicator will flash red and yellow sequentially once every 30 seconds. To erase these alarm reminders, press the Test/Silence button. Note that the smoke/CO alarm reminder will not work if the device is battery-powered.



## Device Status Checklist

Status	LED Indicator		Buzzer	Response
Power On	Flashes yellow, green, and red in sequence eight times.		One quick beep.	/
Standby Mode	AC Power: the LED indicator is solid green.		/	/
	DC Power: the LED indicator flashes green once every 60 seconds.		/	/
Smoke Alarm	Initiating Device	Flashes red three times every four seconds.	Three long beeps every four seconds.	/
	Other Interconnected Devices	Flash red and green in sequence every four seconds.		
CO Alarm	Initiating Device	Flashes red four times every 5.8 seconds.	Four quick beeps every 5.8 seconds.	/
	Other Interconnected Devices	Flash red four times and green once every 5.8 seconds.		

Device Test	Test a single device	Flashes red	Two sets of three long beeps, then two sets of four quick beeps.	To test a single device, press the Test/Silence button.
	Test all interconnected devices	Initiating device flashes red. Other interconnected devices flash red and green in sequence, then flash red.		To test all interconnected devices, hold down the Test/Silence button on any device. The buzzer keeps beeping until you release the Test/Silence button.
Silence Function	Silence a smoke alarm	Flashes red three times every four seconds.	/	The silence duration is set for nine minutes. After that, the device will alarm again if smoke concentration reaches the alarm level.
	Silence a CO alarm	Flashes red four times every 5.8 seconds.	/	The silence duration is set for nine minutes, but the device will alarm when the CO concentration reaches the alarm level after six minutes.
	Silence a low-battery warning	Flashes yellow once every 60 seconds.	/	The silence duration is set for 10 hours, at which point the device will exit silence function.
	Silence an end-of-life signal	Flashes yellow three times every 60 seconds.	/	The silence duration is set for 22 hours, at which point the device will exit silence function.
	Exit the silence function	Flashes green three times.	/	/

Low Battery Warning	Flashes yellow once every 60 seconds.	Beeps once every 60 seconds.	Replace the battery immediately.
Malfunction	Flashes yellow twice every 60 seconds.	Beeps twice every 60 seconds.	Clean your device. If the device still does not function properly, replace the device immediately.
End of Life	Flashes yellow three times every 60 seconds.	Beeps three times every 60 seconds.	Replace the entire device immediately.

## Technical Specifications

Power Supply	120 V AC (60 Hz, 45 mA max, and 9 V Alkaline battery backup)
Sensor Type	Smoke: Photoelectric
	CO: Electrochemical
Product Lifespan	10 years
Safety Standards	UL 217 and UL 2034
Smoke Sensitivity	1.3–3.0% obs/ft
CO Sensitivity	70 ppm for 60–240 minutes
	150 ppm for 10–50 minutes
	400 ppm for 4–15 minutes
Operating Temperature	40–100°F (4.4–37.8°C)
Operating Relative Humidity	10%–85% RH (non-condensing)
Alarm Noise Level	≥ 85 dB at 10 feet (3 m) @ 3.2 ± 0.3 kHz pulsing alarm
Silence Duration	≤ 9 minutes

## Maintenance

This device has been designed to require little work or maintenance. However, to ensure optimum long-term performance, please follow the steps listed below:

- Clean your alarm with a soft, damp cloth once a month. Do not disassemble the device or clean the interior. Doing so will void your warranty.
- Do not clean with detergents or solvents, or spray air fresheners or hair spray near the device, as these may lead to a malfunction.
- Do not paint the device, as it will seal the vents and reduce the sensitivity of the smoke sensors.
- Do not tamper with this device, as this may lead to electrical shock or malfunction.

### Weekly Test

Test the device once a week by pressing the Test/Silence button to check if the device is functioning properly. Note that this only tests the electronics in your alarm rather than the smoke and CO sensors.

### Battery Replacement

If the backup battery is depleted, the LED indicator will flash yellow with one beep every 60 seconds. Follow the steps below to replace the battery immediately. Note that this alarm requires a standard 9 V lithium battery.

1. Open the battery compartment and remove the old battery.
2. Insert a new battery, making sure it is aligned properly. Match the terminals on the end of the batteries with the terminals of the device.
3. Close the battery compartment, then test the device by pressing the Test/Silence button.



#### WARNING

Disconnect AC power before changing the battery, Shock hazard exists if AC power is miswired.

## Troubleshooting

Description	Problem	Solution
The device does not alarm during a test.	Improper wire connection or operation	1. Turn off the power and check wire connection. 2. Firmly press the Test/Silence button.
False alarms are triggered intermittently while cooking or showering.	Improper installation location	Avoid installing alarms near cooking appliances, dusty areas, showers, or any area where the temperature drops below 40°F (4.4°C) or rises above 100°F (37.8°C).
The device circuit is abnormal and does not work normally.	Wrong connection of AC line	If the AC line is not connected correctly, the device will short-circuit, become damaged, and will not work properly. When connecting the AC line, please carefully read the instructions in the manual, and make sure the wiring is correct.
The LED indicator flashes yellow once every 60 seconds with one beep.	Low battery warning	Replace the battery immediately. If an immediate replacement is not possible, you may press the Test/Silence button to silence the alarm for 10 hours.
	No battery installed	If the device does not have a battery installed, a low battery alert will appear.
The LED indicator flashes yellow twice every 60 seconds with two beeps.	Malfunction	Clean your alarm. If the problem persists, replace the device.
The LED indicator flashes yellow three times every 60 seconds with three beeps.	End-of-life signal	Replace the battery immediately. If an immediate replacement is not possible, you may press the Test/Silence button to silence the alarm for 22 hours.

The LED indicator flashes red and yellow sequentially every 5 seconds and there is no alarm sound.	Smoke reminder	Dangerous smoke was detected and smoke concentration decreased below the alarm level. Please check the surroundings immediately. To erase the reminder, press the test/silence button and the alarm will return to normal working mode.
The LED indicator flashes red and yellow sequentially every 30 seconds and there is no alarm sound.	CO reminder	Dangerous CO levels were detected and CO concentration decreased below the alarm level. Please check the surroundings immediately. To erase the reminder, press the test/silence button and the alarm will return to normal working mode.

## Safety

Safety information informs you of important instructions and potential hazards. Please carefully read this section before installation and operation. Note that this device is only for home use.

### General Safety Information

#### IMPORTANT

- This alarm is designed to detect carbon monoxide from combustion sources and is only approved for home use.
- This alarm is not to be used with detector guards unless the combination has been evaluated and found suitable for that purpose.
- Constant exposure to high or low humidity levels can reduce battery life and impair performance.

#### CAUTION

This smoke & carbon monoxide alarm has two separate sensors that work independently of each other. The carbon monoxide sensor will not detect fire or any other gases, but alerts you to the presence of carbon monoxide gas at the sensor. Carbon monoxide gas may also be present in other areas. The smoke sensor will only indicate the presence of smoke at the sensor. The smoke sensor is not designed to detect gas, heat, or flames.

#### WARNING

- Never ignore any alarm, as this may result in serious injury or even death.
- The silence function will not remove any sources of danger. It is merely for convenience. Check your home safety for any potential dangers when an alarm is triggered. Failure to do so may result in serious injuries or even death.
- Test this smoke/CO alarm once a week. If the alarm ever fails to test correctly, replace it immediately! If the alarm is not working properly, it will not alert you to a problem.
- This product is intended for use in indoor households. It is not designed to measure CO levels in compliance with occupational safety and health administration (OSHA) commercial or industrial standards. Individuals with medical conditions that may make them more sensitive to carbon monoxide should consider using devices that provide audible and visual signals for carbon monoxide concentrations under 30 ppm. For additional information on carbon monoxide or related medical conditions, contact your physician.
- The replacement date that appears on the device is the date beyond which the device may no longer detect carbon monoxide accurately, at which point the device should be replaced.
- This device is designed to protect individuals from the acute effects of carbon monoxide exposure. It may not fully safeguard individuals with specific medical conditions. If you have any concerns, consult a medical practitioner.
- Do not disconnect power from an AC powered unit to silence a false alarm. Doing so will disable the unit and remove your protection.

## Smoke Alarm

### Limitations of Smoke Alarms

Alarms reduce deaths resulting from home fires worldwide. However, smoke alarms will only work when properly located, installed, and maintained, and only if smoke reaches the alarms.

- Smoke alarms may not wake up all individuals. Make sure you create an escape plan, and you practice fire drills with all family members.
- Smoke alarms cannot work without power. If they are battery powered, they cannot work if the batteries are missing, dead, or disconnected. If the alarm is wired, it cannot work during extended power outages, as the backup battery will die. X-Sense units will notify you in advance when batteries are running low so that you have time to replace them.
- Smoke will not be able to reach the smoke sensor while the dust cover is in place. The dust cover must be removed.
- Smoke alarms cannot detect fires if the smoke does not reach the alarm. For example, if a door is closed, smoke may not reach the smoke alarm. This is why you should have a smoke alarm in every bedroom and in hallways, as bedroom doors are often closed at night.

- Smoke alarms may not be heard. Although the smoke alarm is equipped with a loud buzzer measuring at 85 dB, it may not be heard if 1) people have consumed alcohol or drugs, 2) the alarm is drowned out by noise from a stereo, TV, traffic, air conditioner, or other appliances, 3) residents are hearing impaired or have high-frequency hearing loss. Special smoke alarms should be installed for the hearing impaired.
- This smoke alarm alone is not a suitable substitute for complete fire detection systems in places that house lots of people, such as flats, condominiums, hotels, guest houses, residence halls, hospitals, long-term health care facilities, nursing homes, daycare facilities, or group homes of any kind. It is also not a suitable substitute for a complete fire detection system in warehouses, industrial facilities, commercial buildings, and special-purpose non-residential buildings which require special fire detection and alarm systems. Depending on the building codes in your area, this smoke alarm may be used to provide additional protection in these facilities.

## CO Alarm

### CO Alarm Level

This alarm will sound an alarm when the following CO concentrations are detected within the time periods listed:

- 70 ppm for 60–240 minutes
- 150 ppm for 10–60 minutes
- 400 ppm for 4–15 minutes

When the CO concentration reaches the alarm level, this alarm will emit four short beeps, and the LED indicator will flash red every 5.8 seconds.

### CO Concentration and Symptoms

The table below shows the effects that different levels of CO can have on the body:

Parts per million (ppm)	Effects on adults
100	Slight headache, nausea, fatigue (flu-like symptoms).
200	Dizziness and headache within two or three hours.
400	Nausea, frontal headache, drowsiness, confusion, and rapid heart rate. Risk to life after over three hours of exposure.
800	Severe headaches, convulsions, vital organ failures. Death possible within two or three hours.

## Limitations of CO Alarms

- The alarm may not wake up everyone in the house. If children or other people do not quickly wake up, or if you have infants or family members with limited mobility, make sure they are assisted during an emergency.
- This alarm will not detect CO that does not reach the sensor. Doors or other obstructions may prevent CO from reaching the alarm, so make sure there is at least one alarm installed in sleeping areas, where the door is often closed at night.
- CO alarms may not sense CO on another level of the house. For example, a CO alarm on the second level may not sense CO in the basement. Therefore, placing CO alarms on each level of the house is recommended.
- CO alarms may not always be heard. The alarm noise level is over 85 dB at a distance of 10 feet (3 m). However, if the CO alarm is installed outside the bedroom, it may not wake up a sound sleeper or someone who has recently used drugs or has been drinking alcohol. This is especially true if the door is closed or only partially open. Even people that are already awake may not hear the alarm if the sound is drowned out by distance or closed doors. Noise from traffic, stereos, radios, televisions, air conditioners, or other appliances can also prevent people from hearing the alarm. This CO alarm is not intended for people who are hearing impaired.
- CO alarms are not a substitute for life insurance. Though these CO alarms warn you of increasing CO levels, we do not warrant or imply in any way that they will protect anyone from CO poisoning. Homeowners and renters must still insure their lives.
- CO alarms have a limited life. Although the CO alarm and all of its parts have passed stringent testing and are designed to be as reliable as possible, any of these parts could fail at any time. Therefore, it is strongly recommended that you test your CO alarm weekly.
- CO alarms are not foolproof. Like all other electronic devices, CO alarms have limitations. They can only detect CO that reaches the sensor. They may not give an early warning of rising CO levels if the CO is coming from a remote part of the house or is far away from the CO alarm.

## Electrical Shock Hazard

- Turn off power to the area where you want to install this unit at the circuit breaker or fuse box before installation. Failure to turn off power before installation may result in serious electrical shock, injury, or death.
  - Do not restore power until all alarms are completely installed. Doing so may result in serious electrical shock, injury, or death.
  - Turn off power to the area where the alarm is installed before removing it from the mounting bracket.
  - Failure to turn off power first may result in serious electrical shock, injury, or death.
- If any unit in the series does not alarm, turn off power and re-check all connections. After that, if it does not alarm yet, replace it immediately.

- Attempting to disconnect the power connector from the unit while the power is on may result in electrical shock, serious injury, or death.
- Failure to meet any of the above requirements could damage the units and cause them to malfunction.
- The alarm cannot be operated from power derived from a square wave, modified square wave, or modified sine wave inverter. These types of inverters are sometimes used to supply power to structures in off-grid installations, such as solar or wind-derived power sources. These power sources produce high peak voltages that can damage the alarm.
- Never disconnect power from an AC-powered unit to stop a false alarm. Doing so will disable the unit and remove your protection. To silence an alarm, open a nearby window or fan the smoke away from the unit. The alarm will automatically reset when it returns to normal operation.
- Improper wiring of the power connector will cause damage to the alarm and may lead to a non-functioning alarm. Test the alarm to ensure proper installation.

## FCC Compliance

This device has been tested and found to comply with the limits for a Class B digital device, pursuant to Part 15 of the FCC rules. These limits are designed to provide reasonable protection against harmful interference in a residential installation. This device generates, uses and can radiate radio frequency energy and, if not installed and used in accordance with the instructions, may cause harmful interference to radio communications. However, there is no guarantee that the interference will not occur in a particular installation. If this device does cause harmful interference to radio or television reception, which can be determined by turning the device off and on, the user is encouraged to try to correct the interference by one or more of the following measures:

- Reorient or relocate the receiving antenna.
- Increase the separation between the device and receiver.
- Connect the device into an outlet on a circuit different from that of the receiver.
- Consult the dealer or an experienced radio or TV technician for help.

This device complies with part 15 of the FCC Rules. Operation is subject to the following two conditions: (1) The device may not cause harmful interference, and (2) the device must accept any interference received, including interference that may cause undesired operation.

Changes or modifications not expressly approved by the party responsible for compliance could void the user's authority to operate the equipment.

## Environmental Protection

Waste electrical products should not be disposed of with household waste. Please recycle where facilities are available. Please check with your local authorities or retailers for recycling advice.



## Manufacturer and Service Information

X-Sense Innovations Co., Ltd.

Address: B4-503, Kexing Science Park, 15 Keyuan Road, Shenzhen, 518057, CHINA

Email: [support@x-sense.com](mailto:support@x-sense.com)