

# X-SENSE

## Wi-Fi Combination Smoke and Carbon Monoxide Alarm

---

Model: SC07-WX



Conforms with UL 217 and UL 2034 standards  
X-Sense Innovations Co., Ltd.

F.1.05.SC0707 V1.0

This user manual contains important information about your combination smoke and carbon monoxide alarm's operation. To ensure proper use and trouble-free operation, please read this manual carefully and store it in a safe place for future reference.

## Introduction

This device is a battery-powered Wi-Fi combination smoke and carbon monoxide alarm. After the device is connected to the X-Sense app, you can remotely use your smartphone to control the device, receive app push notifications, and make daily use more convenient.

All X-Sense combination smoke and carbon monoxide alarms conform with regulatory requirements, including UL 217 and UL 2034 Standards and are designed to detect both smoke and carbon monoxide.

This unit adopts photoelectric technology to detect smoke which is generally more sensitive than ionization technology. It is effective at detecting large particles, which tend to be produced in greater amounts by smoldering fires. These types of fires may smolder for hours before bursting into flame. Sources of these fires may include cigarettes burning in couches or bedding.

Carbon monoxide (CO) is odorless, tasteless and invisible—it's a silent killer. Using electrochemical sensing technology, this unit can detect increased levels of carbon monoxide early, protecting your family from the dangers of carbon monoxide.

\* The installation of the apparatus should not be used as a substitute for proper installation, use and maintenance of fuel-burning appliances including appropriate ventilation and exhaust systems.

\* This apparatus is to be installed by a competent person.

\* It is not tested for use in a caravan or boat.

**NOTE: For maximum protection, use smoke and CO alarms on each level and in every bedroom of your home.**

## NEVER IGNORE THE SOUND OF THE ALARM!

Determining what type of alarm has sounded is easy with your X-Sense combination smoke and carbon monoxide alarm. The buzzer will inform you of the type of situation occurring.

## Package Contents

1 × Alarm Unit (Pre-installed Battery)  
1 × Mounting Bracket  
3 × Screws

3 × Anchor Plugs  
1 × User Manual  
1 × Carbon Monoxide Safety Sticker

## Technical Specifications

Power Supply	CR123A lithium battery (replaceable)
Sensor Type	Smoke: Photoelectric CO: Electrochemical
Battery Life	1 year
Product Life	10 years
Safety Standards	UL 217 and UL 20234
CO Sensitivity	70 ppm: 60-240 minutes
	150 ppm: 10-50 minutes
	400 ppm: 4-15 minutes
Operating Temperature	40-100°F (4.4-37.8°C)
Operating Relative Humidity	10%–85% RH (non-condensing)
Alarm Loudness	≥85 dB at 3 m (10 ft) @ 3.2 ± 0.3 kHz pulsing alarm
Silence Duration	≤ 9 minutes
App	X-Sense Home Security (both Android and iOS supported)
Number of Allowed Devices	Each X-Sense account can create 5 houses, and each house can add 24 Wi-Fi combination alarms. Additionally, you have the option to add Wi-Fi smoke alarms, Wi-Fi carbon monoxide alarms, and base stations.
Wireless Frequency	2.4 GHz (Incompatible with 5 GHz Wi-Fi network)
Wi-Fi Transmission Range	170 ft (50 m)
Wireless Protocol	IEEE 802.11b/g/n

### NOTE:

- 1. Battery life is calculated on the current ratings in the standby mode with weekly testings. If its operation mode changes to an alarming condition, the battery life will be decreased accordingly.**
- 2. This alarm functions between 40–100°F (4.4–37.8°C). Prolonged exposure to lower or higher temperatures can reduce battery life and affect device performance. We do not recommend operating the device beyond its temperature range.**

## Product Overview



### CAUTION

THIS SMOKE AND CO ALARM IS DESIGNED FOR INDOOR USE ONLY. DO NOT EXPOSE TO RAIN OR MOISTURE. DO NOT KNOCK OR DROP THE ALARM. DO NOT OPEN OR TAMPER WITH THE ALARM AS THIS COULD CAUSE MALFUNCTION.

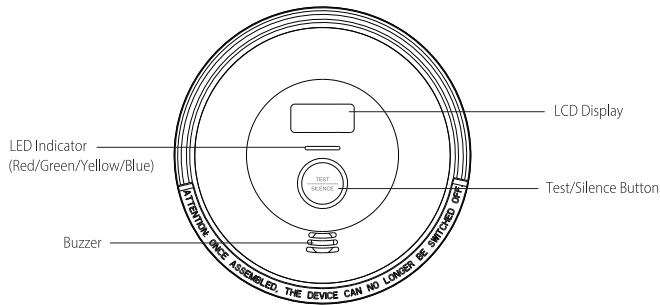

### Test & Silence Button

The Test/Silence button is used to test the unit's electronics and silence it during an alarm. To conduct the weekly test, shortly push the test button once, and the LCD display will activate with a beep, indicating the device is in test mode. The app will send a test push notification to your smartphone. After the test is done, the device will return to standby mode. To save power, the alarm automatically turns off the LCD display following the test.

**NOTE:** After a test has begun, the alarm will sound and the LED indicator will flash red. This does not indicate that smoke/CO is present.

## Buzzer

The alarm will sound when there is smoke or CO present, when you test the alarm, and when there is a fault.

## LED Indicator

The LED indicator will flash in conjunction with the buzzer. Therefore, it will flash during the following states: when powering on, in standby mode, during smoke or CO alarm states, when exiting an alarm state, during test mode, when there is low battery, in silence mode, when there is a fault and when the unit is at the end of its life.

## Low Battery

The LED indicator will flash yellow together with one beep every 60 seconds. A low battery notification will be sent to your smartphone by the app.

If you press the test button when there is low battery, the low battery signal will temporarily cease for 10 hours.

## End of Life

Once the maximum lifetime (10 years) is reached, the alarm will deliver 3 beeps and the LED indicator will flash yellow 3 times every 60 seconds. This end-of-life signal can be temporarily silenced for 22 hours by pressing the test button. An end-of-life push notification will be sent to your smartphone by the app.

The end-of-life silence feature can only be used for a total of 30 days. After 30 days, the end-of-life signal cannot be silenced.

To help identify the date to replace the alarm, write down the date of first operation on the dedicated label, located on the side of the alarm.

## CO Alarm Levels

This X-Sense combination smoke and carbon monoxide alarm is programmed to sound an alarm at the following CO concentrations within the time periods listed:

**70 ppm for 60–240 minutes,  
150 ppm for 10–50 minutes,  
and 400 ppm for 4–15 minutes.**

When CO is detected and the alarm sounds, the CO concentration will be displayed on the LCD and a blue backlight will be lit. The LED indicator will flash red and the alarm will issue 4 short beeps, repeating the cycle every 5.8 seconds. An alarm push notification will be sent to your smartphone by the app.

## CO Concentration and Symptoms

The table below shows the effects of different levels of CO poisoning on the body:

Parts per Million (PPM)	Effects on Adults
100	Slight headache, nausea, fatigue (flu-like symptoms).
200	Dizziness and headache within 2–3 hours.
400	Nausea, frontal headache, drowsiness, confusion and rapid heart rate. Risk to life after over 3 hours of exposure.
800	Severe headaches, convulsions, vital organ failures. Death possible within 2–3 hours.

## ⚠ WARNING

THIS DEVICE IS DESIGNED TO PROTECT INDIVIDUALS FROM ACUTE EFFECTS OF CARBON MONOXIDE EXPOSURE. IT MAY NOT FULLY SAFEGUARD INDIVIDUALS WITH SPECIFIC MEDICAL CONDITIONS. IF IN DOUBT, CONSULT A MEDICAL PRACTITIONER.

## Device Setup within the App

### Sign Up



Download on the  
App Store



GET IT ON  
Google Play

To download the app, search for **X-Sense Home Security** in the Apple App Store or Google Play, or simply scan the QR code. Create an account using a valid email address. If you already have an account, make sure it is updated to the latest version.

### Before connecting alarms, make sure that:

1. Know your Wi-Fi network name and password.
2. Make sure you are connecting alarms to a 2.4 GHz Wi-Fi network (incompatible with 5 GHz Wi-Fi network).
3. Make sure the Bluetooth on your phone is turned on.



## Activate the Device

This device is equipped with a battery insulating film to ensure it will not be powered on during transportation before it has shipped from the factory. When installing this product, you will need to pull out the film before powering on and activating the device.

## Add a Combination Smoke and Carbon Monoxide Alarm

1. Tap "⊕" in the right top corner of the app homepage, select "Combination Smoke and CO Alarms" and tap "Next" to add a device.
2. Remove the insulating film to power up the alarm.
3. Enter a name for the alarm. Select the home you created or create a new home for the alarm, then select the room in which it is installed. If you create a new home, you will need to enter a name and select the country or region in which you live.
4. Press and hold the Test/Silence button on the alarm for 5 seconds until it flashes blue, indicating that the device is waiting to connect to the Wi-Fi. Then, tap **"Operation Confirmed"** before the LED goes off.

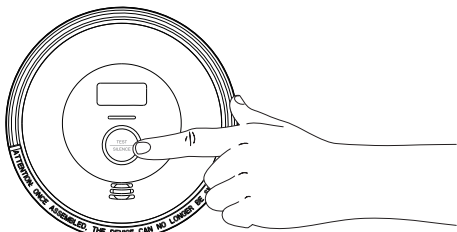

5. Connect to a 2.4 GHz Wi-Fi network and make sure you enter the correct password. Then, the alarm will enter the pairing process. Make sure the LED indicator is still flashing blue; or else you need to press it to make it flash blue again.
6. When successfully connected, the device will beep once, the backlight turns off, and the LED stops flashing. You will see the Wi-Fi combination alarm on the app's device list.

*If you fail to add the alarm to the network within 2 minutes, the device will automatically exit the network configuration. To re-enter the network configuration, you need to repeat the above steps.*

### NOTE:

1. If your router supports a dual band network with both 2.4 GHz and 5 GHz, please create separate SSIDs for the 2.4 GHz and 5 GHz channels. This device is only compatible with a 2.4 GHz Wi-Fi network.
2. To promote successful Wi-Fi connection, make sure you place the alarm within the router range, and that you enter the correct password.

## Set the Preferences for Your Mobile App

### Push Notifications

You can choose to receive app push notifications when any change is made to your system. It is highly recommended that you limit push notifications, as too many notifications can become redundant and load your phone, which can quickly become a nuisance. Furthermore, the more push notifications you allow, the more power your alarm will consume, which will reduce battery life.

### Record History

To access data or check device status, tap the History button on the bottom.

### Offline Notifications

Offline notifications are used to notify you if the alarm disconnects from the Wi-Fi. Note that this notification may not be sent instantly, as the alarm reports to the cloud service center at set intervals.

### CO Alarm Precaution

Dangerous CO concentration is detected, but has not reached the alarm status. The app will show a "CO Alarm Precaution" message, and an app push notification will be sent to your smartphone. Potential dangerous CO conditions exist.

### Alarm Mode

When the device detects smoke or CO, the unit will sound an alarm and the LED will flash red. The app will show a "Smoke Alarm Triggered" or "CO Alarm Triggered" notification, and an app push notification will be sent to your smartphone. When the smoke or CO concentration drops below the alarm threshold, the alarm sound will stop, and the LED will flash green once every second for 5 seconds. Then, it will automatically enter standby mode. When the alarm ends, an app push notification will be sent to your smartphone.

## Silence Mode

**Smoke Silence Mode:** Press the test button during an alarm to have the unit enter silence mode. If the smoke concentration has reached an alarm level, after the silence time has expired, this unit will continue to alarm until the smoke concentration decreases to a safe, low level. Otherwise, the alarm will enter the normal mode after 9 minutes.

**CO Silence Mode:** Press the test button during an alarm to have the unit enter silence mode. If the CO density still exceeds the alarm threshold, the unit will re-enter the alarm state. Otherwise, the unit will exit the silence mode after 9 minutes and resume normal operation.



If there is a false alarm, you can temporarily silence it by pressing the test/silence button on the device or in the app. You will receive an instant notification from the app telling you that the device has been temporarily silenced. The alarm sound will stop and the LED will flash red to remind you that the alarm has been silenced. The alarm will automatically exit silence mode after 9 minutes.



During silence mode, if the carbon monoxide concentration is still greater than 70 ppm after 6 minutes, the device will be triggered again; if not, the device will automatically exit the silence mode after 9 minutes, and the LED will flash green 3 times continuously.



**Note: If smoke levels are too high, the alarm cannot be silenced.**









## LCD Display

While detecting CO, the LCD will display different indications to help you understand what to do, as shown below:

Mode		LCD Display	LED Indicator	Audible Alarm	Remarks
Powering On	First-time use without connecting to the Wi-Fi.		Runs through 8 cycles (yellow/green/red) in sequence.	1 quick beep.	Make sure the battery insulating film is removed and the device is turned on.
	The battery is replaced and the device has connected to the Wi-Fi before.		The LED indicator flashes blue until the Wi-Fi connection is successful.		Make sure the battery is properly installed and the device is turned on.
Standby Mode			Flashes green once every 60 seconds.	None.	None.
Alarm Mode	Unit detects smoke and initiates an alarm.		Flashes red 3 times every 4 seconds.	3 long beeps every 4 seconds.	Dangerous smoke concentration is detected. The app will show a "Smoke Alarm Triggered" message, and an app push notification will be sent to your smartphone. Open nearby windows and doors, and immediately move to fresh air.

Unit detects CO and initiates an alarm.		A CO concentration ranging from 30 to 999 ppm has been present for a certain time period. The LED indicator flashes red 4 times every 5.8 seconds.	4 quick beeps repeating every 5.8 seconds.	Dangerous CO concentration is detected, and has reached the alarm status. The app will show a "CO Alarm Triggered" message, and an app push notification will be sent to your smartphone. Open nearby windows and doors, and immediately move to fresh air.
Unit detects CO (alarm not initiated).		A CO concentration level ranging from 30 to 999 ppm has been detected, but for less than the allotted detection period. The LED indicator flashes green once every 60 seconds.	None.	Dangerous CO concentration is detected, but has not reached the alarm status. Potentially dangerous CO conditions exist. The app will show a "CO Alarm Precaution" message, and an app push notification will be sent to your smartphone. Please search for the CO source first. Open nearby windows and doors, and immediately move to fresh air.

Unit detected smoke and initiated an alarm.		The LED indicator flashes green once every second for 5 seconds.	None.	Alarm cancellation: when the smoke concentration level drops below the alarm threshold, the alarm signal will stop. Then, the alarm goes back to the standby mode after testing.
Unit detected CO and initiated an alarm.		The LED indicator flashes green once every second for 5 seconds.	None.	Alarm cancellation: when the CO concentration level drops below the alarm threshold, the alarm signal will stop. Then, the alarm goes back to the standby mode after testing.
<b>Test Mode</b>		2 sets of 3 red flashes followed by 2 sets of 4 red flashes.	2 sets of 3 long beeps followed by 2 sets of 4 quick beeps.	Press the Test/Silence button.
<b>Silence Mode</b>		Flashes red 3 times every 4 seconds.	None.	Smoke silence mode: After 9 minutes, the unit will exit silence mode. CO silence mode: After 9 minutes, the unit will exit silence mode.

		Flashes yellow once every 60 seconds.	None.	Silence mode during low battery: After 10 hours, the unit will exit silence mode.
				
		Flashes yellow 3 times every 60 seconds.	None.	Silence mode during the end of cycle: After 22 hours, the unit will exit silence mode.
		Flashes green 3 times.	None.	Exiting silence mode.
Low Battery		Flashes yellow once every 60 seconds.	One beep every 60 seconds.	Replace the unit immediately.
				
Fault		Flashes yellow 2 times every 60 seconds.	2 beeps every 60 seconds.	Please clean your alarm and see if it is working normally. If "E03" or "E04" continues to display, the unit has malfunctioned and must be replaced immediately.
				
End of Life		Flashes yellow 3 times every 60 seconds.	3 beeps every 60 seconds.	Replace the unit immediately.

### Fire Safety Tips

#### Follow these safety rules to prevent hazardous situations:

1. Use smoking materials properly. Never smoke in bed.
2. Keep matches or lighters away from children.
3. Store flammable materials in proper containers.

4. Keep electrical appliances in good condition and don't overload electrical circuits.
5. Keep stoves, barbecue grills, fireplaces and chimneys grease-free and debris-free.
6. Never leave anything cooking on the stove unattended.
7. Keep portable heaters and open flames, like candles, away from flammable materials.
8. Don't let rubbish accumulate.
9. Keep alarms clean, and test them weekly.
10. Replace alarms immediately if they are not working properly. Smoke alarm that do not work cannot alert you to a fire.
11. Keep at least one working fire extinguisher on every floor, and an additional one in the kitchen.
12. Have fire escape ladders or other reliable means of escape from an upper floor in case stairs are blocked.

### Basic Safety Information

#### **⚠ IMPORTANT**

1. DANGERS, WARNINGS, AND CAUTIONS ALERT YOU TO IMPORTANT OPERATING INSTRUCTIONS OR TO POTENTIALLY HAZARDOUS SITUATIONS. PAY SPECIAL ATTENTION TO THESE SITUATIONS.
2. THIS COMBINATION SMOKE & CARBON MONOXIDE ALARM IS ONLY APPROVED FOR HOME USE.
3. THIS CARBON MONOXIDE ALARM IS DESIGNED TO DETECT CARBON MONOXIDE FROM ANY SOURCE OF COMBUSTION.
4. CONSTANT EXPOSURES TO HIGH OR LOW HUMIDITY MAY REDUCE BATTERY LIFE.
5. SMOKE ALARMS ARE NOT TO BE USED WITH DETECTOR GUARDS UNLESS THE COMBINATION HAS BEEN EVALUATED AND FOUND SUITABLE FOR THAT PURPOSE.

#### **⚠ CAUTION**

THIS SMOKE & CARBON MONOXIDE ALARM HAS TWO SEPARATE ALARMS WHICH WORK INDEPENDENTLY. THE CARBON MONOXIDE ALARM IS NOT DESIGNED TO DETECT FIRE OR ANY OTHER GAS. IT WILL ONLY INDICATE THE PRESENCE OF CARBON MONOXIDE GAS AT THE SENSOR. CARBON MONOXIDE GAS MAY BE PRESENT IN OTHER AREAS. THE SMOKE ALARM WILL ONLY INDICATE THE PRESENCE OF SMOKE THAT REACHES THE SENSOR. THE SMOKE ALARM IS NOT DESIGNED TO DETECT GAS, HEAT OR FLAMES.

## **⚠ WARNING**

1. NEVER IGNORE ANY ALARM. FAILURE TO RESPOND CAN RESULT IN SERIOUS INJURY OR DEATH.
2. THE SILENCE FEATURE IS ONLY FOR YOUR CONVENIENCE AND WILL NOT CORRECT A PROBLEM. ALWAYS CHECK YOUR HOME FOR A POTENTIAL PROBLEM AFTER ANY ALARM. FAILURE TO DO SO CAN RESULT IN INJURY OR DEATH.
3. TEST THIS SMOKE/CO ALARM ONCE A WEEK. IF THE ALARM EVER FAILS TO TEST CORRECTLY, REPLACE IT IMMEDIATELY! IF THE ALARM CANNOT WORK PROPERLY, IT WILL NOT ALERT YOU TO A PROBLEM.
4. THIS PRODUCT IS INTENDED FOR USE IN ORDINARY INDOOR LOCATIONS OF FAMILY LIVING UNITS. IT IS NOT DESIGNED TO MEASURE CO LEVELS IN COMPLIANCE WITH OCCUPATIONAL SAFETY AND HEALTH ADMINISTRATION (OSHA) COMMERCIAL OR INDUSTRIAL STANDARDS. INDIVIDUALS WITH MEDICAL CONDITIONS THAT MAY MAKE THEM MORE SENSITIVE TO CARBON MONOXIDE MAY CONSIDER USING WARNING DEVICES WHICH PROVIDE AUDIBLE AND VISUAL SIGNALS FOR CARBON MONOXIDE CONCENTRATIONS UNDER 30 PPM. FOR ADDITIONAL INFORMATION ON CARBON MONOXIDE AND YOUR MEDICAL CONDITION CONTACT YOUR PHYSICIAN.
5. THE REPLACEMENT DATE THAT APPEARS ON THE DEVICE IS THE DATE BEYOND WHICH THE DEVICE MAY NO LONGER DETECT CARBON MONOXIDE ACCURATELY AND SHOULD BE IMMEDIATELY REPLACED.
6. THIS DEVICE IS DESIGNED TO PROTECT INDIVIDUALS FROM THE ACUTE EFFECTS OF CARBON MONOXIDE EXPOSURE. IT MAY NOT FULLY SAFEGUARD INDIVIDUALS WITH SPECIFIC MEDICAL CONDITIONS. IF IN DOUBT, CONSULT A MEDICAL PRACTITIONER.

## **Installation Instructions**

### **Installation Locations**

1. Prioritize the installation of a smoke alarm in the bedroom and walkways, and make sure you can hear the alarm from all sleeping areas. In a home with several bedrooms, install an alarm in every bedroom. If you install only one smoke alarm in your home, install the alarm near to all bedrooms where possible, and not in a basement or furnace room.
2. Install an alarm above the stairway and on every floor of the house.
3. Smoke, heat and anything burning will spread horizontally after rising to the ceiling, so install the alarm in the middle of the ceiling where possible. Ensure the alarm is within working distance of all corners of the room.
4. If an alarm cannot be installed in the middle of a ceiling, install at a distance of 20 in (50 cm) away from the corners of the room.
5. If an alarm is installed on a wall, it should be at a distance of 4–12 in (10–30 cm) below the ceiling.
6. If the length of a room or hall is beyond 30 ft (900 cm), several alarms should be installed in the same room.
7. When the wall or ceiling is angled, the alarm needs to be installed within 3 ft (90 cm) of the highest wall or ceiling point (measured horizontally) in the room.

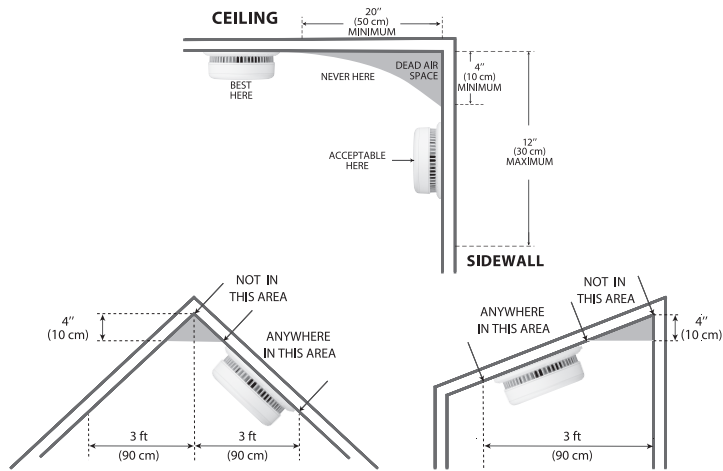

## **Recommended Placement**

### **⚠ WARNING**

1. THIS ALARM SHOULD BE INSTALLED BY A COMPETENT PERSON.
2. INSTALLATION OF THE ALARM SHOULD NOT BE USED AS A SUBSTITUTE FOR PROPER INSTALLATION, USE AND MAINTENANCE OF FUEL BURNING APPLIANCES INCLUDING APPROPRIATE VENTILATION AND EXHAUST SYSTEMS.

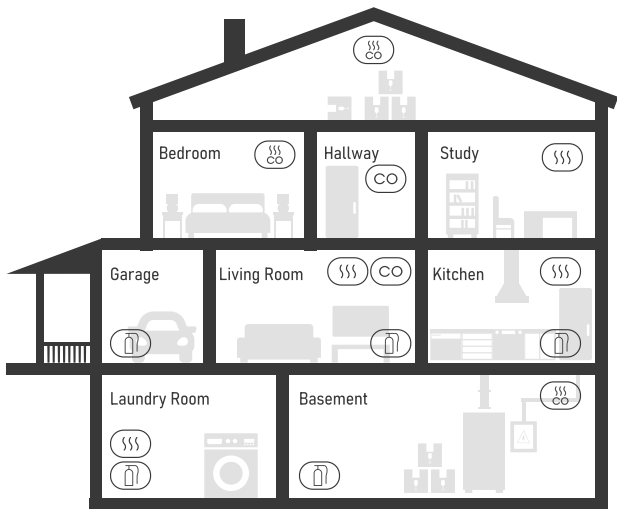

- |   |  |
|---|--|
|  SMOKE ALARMS      |  CARBON MONOXIDE ALARMS |
|  SMOKE & CO ALARMS |  FIRE EXTINGUISHERS     |

**NOTE:** If a smoke alarm is installed in a kitchen, ensure it has an easily accessible silence button and install the alarm as far away from the stove and sink as possible to avoid false alarms.

## How to Install This Alarm

### **⚠️ IMPORTANT**

THIS COMBINATION SMOKE/CO ALARM IS DESIGNED TO BE MOUNTED ON THE CEILING OR WALL.

### **⚠️ WARNING**

FAILURE TO PROPERLY INSTALL AND ACTIVATE THIS ALARM WILL PREVENT PROPER OPERATION OF THE ALARM AND WILL PREVENT ITS RESPONSE TO FIRE HAZARDS OR CO.

## Locations to Avoid

**WARNING:** This product is intended for use in ordinary indoor locations of family living units. It is not designed to measure CO levels in compliance with the Occupational Safety and Health Administration (OSHA) commercial or industrial standards.

- Do not install in garages, kitchens, furnace rooms or bathrooms! Do not install within 5 ft (1.5 m) of cooking appliances.
- Do not install within 3 ft (90 cm) of the following: The door to a kitchen, or a bathroom that contains a tub or shower, forced air supply ducts used for heating or cooling, ceiling or whole house ventilating fans, or other high air flow areas. Avoid excessively dusty, dirty or greasy areas. Dust, grease or household chemicals can contaminate the alarm's sensors, causing the alarm to not operate properly.
- Place the alarm where drapes or other objects will not block the sensors. Smoke and CO must be able to reach the sensors to accurately detect these conditions. Do not install in peaks of vaulted ceilings, "A" frame ceilings or gabled roofs. Keep out of damp and humid areas.
- Install at least 1 ft (30 cm) away from fluorescent lights, as electronic noise may cause nuisance alarms.
- Do not place in direct sunlight and keep out of insect-infested areas. Extreme temperatures will affect the sensitivity of the smoke/CO alarm.
- Do not install in areas where the temperature is colder than 40°F (4.4°C) or hotter than 100°F (37.8°C), such as garages and unfinished attics.
- Do not install in areas where the relative humidity (RH) is above 85% or below 10%. Place away from doors and windows that open to the outside.
- Smoke alarms are not to be used with detector guards unless the combination (alarm and guard) has been evaluated and found suitable for that purpose.

## Mounting Steps

1. Mark 3 screw holes on the wall or ceiling according to the holes of the mounting bracket, and drill the screw holes to a depth of 1.18 in (30 mm) using a Ø 1/4 in (6.0 mm) drill bit. Then insert three plastic anchor plugs into the holes with a hammer.
2. Attach the mounting bracket to the surface of the wall or ceiling with three screws and mount the alarm into the bracket by pushing them together and twisting the unit clockwise.
3. Test the unit by using the Test/Silence button. Ensure the unit sounds in an alarm pattern.

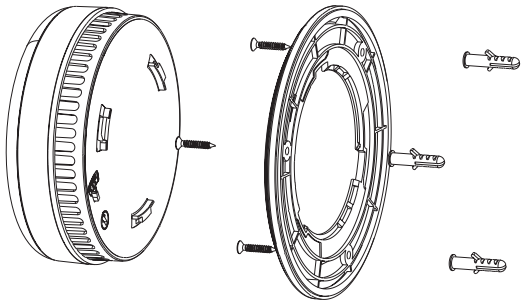

## Alarm Testing

### **⚠ WARNING**

1. NEVER USE AN OPEN FLAME OF ANY KIND TO TEST THIS UNIT. YOU MIGHT ACCIDENTALLY DAMAGE OR SET FIRE TO THE UNIT OR TO YOUR HOME.
2. NEVER USE A VEHICLE EXHAUST TO TEST THIS UNIT. EXHAUST FUMES MAY CAUSE PERMANENT DAMAGE AND VOID YOUR WARRANTY.
3. DO NOT STAND CLOSE TO THE ALARM WHEN THE ALARM IS SOUNDING. EXPOSURE AT CLOSE RANGE MAY BE HARMFUL TO YOUR HEARING. WHEN TESTING, STEP AWAY WHEN THE ALARM BEGINS TO SOUND.

Be sure to test your alarms when you turn them on for the first time use. In addition to the weekly test you should perform, it is also recommended to test the alarm after returning from a long trip or vacation.

<b>Action</b>	Push the Test/Silence button.
<b>Device Response</b>	The device beeps 2 sets of 3 long beeps followed by 2 sets of 4 quick beeps, and the LED will flash red. The LCD will display "--," "PAS," and finally "0." This indicates that the device is functioning properly.
<b>App</b>	The app will show a test notification, and a push notification will be sent to your smartphone by the app.

## Battery Replacement

Remove the old battery and replace with a CR123A battery when the LCD displays the "Lb" message and the LED flashes yellow once every 60 seconds with the buzzer chirping.

When the battery is replaced and the device is turned on, the alarm will beep once while the LED flashes red. Then, the LED will begin flashing blue until the Wi-Fi connection is successful. If the LED flashes for 2 minutes and then stops, this indicates the Wi-Fi connection has failed.

## Maintenance

To keep your smoke/CO alarm in good working order, follow these simple steps:

1. Verify the unit's alarm sound and indicators are working properly by testing the unit once a week.
2. Remove the unit from the ceiling/wall and clean the alarm cover and vents with a soft brush attachment once a month to remove dust and dirt.
3. Never use detergents or other solvents to clean the unit.
4. Avoid spraying air fresheners, hair spray or other aerosols near the alarm.
5. Do not paint the unit. Paint will seal the vents and interfere with the sensor's ability to detect smoke or CO. Never attempt to disassemble the unit or clean inside. Doing so will void your warranty.
6. When removed, place the smoke/CO alarm back in its proper location as soon as possible, to assure continuous protection from fire or carbon monoxide poisoning.
7. When household cleaning supplies or similar contaminants are used, the area should be ventilated.

### If the Smoke Alarm Sounds

1. Don't panic; stay calm. Follow your family's escape plan.
2. Get out of the house as quickly as possible. Don't stop to get dressed or collect anything.
3. Feel doors with the back of your hand before opening them.
4. If a door is cool, open it slowly. Don't open a hot door. Keep doors and windows closed, unless you must escape through them.
5. Cover your nose and mouth with a cloth (preferably damp).
6. Take short, shallow breaths.
7. Meet at your planned meeting place outside your home, and do a head count to make sure everybody got out safely.
8. Call the Fire Department as soon as possible from outside. Give your address, then your name.
9. Never go back inside a burning building for any reason.
10. Contact your Fire Department for ideas on making your home safer.

### If the CO Alarm Sounds

1. Keep calm and immediately move to fresh air. Open all doors and windows to increase the rate of ventilation. Stop using all fuel-burning appliances and ensure, if possible, that they are turned off, e.g. for gas appliances, isolate the emergency control valve.
2. If the alarm continues to be activated, then evacuate the premises. Leave the doors and windows open, and only re-enter the building when the alarm has stopped. In multi-occupancy and multi-storey premises, ensure that all the occupants are alerted to the risk.
3. Get medical help for anyone suffering the effects of carbon monoxide poisoning, and advise that carbon monoxide inhalation is suspected.
4. Telephone the appropriate appliance servicing and/or maintenance agency or, when necessary, the relevant fuel supplier on their emergency number or the national Gas Emergency Service Provider, if appropriate, so that the source of carbon monoxide emissions can be identified and corrected. Unless the reason for the alarm is obviously spurious, do not use the fuel-burning appliances again, until they have been checked and cleared for use by a competent person according to national regulations.

### Troubleshooting

PROBLEM	CAUSE	SOLUTION
The device is not triggered when it is tested with smoke.	The device is not turned on.	Make sure the battery insulating film is removed. If the battery runs out, please replace the battery.
	The smoke is not reaching the sensor properly.	Smoke must enter the smoke sensor through the side openings to activate the device. Please be aware that the top of the device features the buzzer and decorative metal mesh.
	The time duration is insufficient for the device to detect smoke.	Continuous smoke exposure is necessary for the device to be triggered. When smoke reaches the smoke sensor, the device will be activated within about 20 seconds.
	Insufficient smoke concentration.	This product utilizes a photoelectric sensor, requiring sufficient smoke concentration for detection. Higher smoke levels lead to faster alarm response. Avoid using an open flame for testing.
The alarm does not sound during a test.	The device is not turned on.	Please ensure the battery insulating film is removed and the device is turned on. If the battery runs out, replace the battery immediately.
	You don't push the test/silence button firmly.	Make sure you push the test/silence button firmly.
False alarms are triggered intermittently or when residents are cooking, taking showers, etc.	The device is improperly installed.	Install the device far away from kitchen appliances, dusty places, shower areas, and locations where the temperature is over 100°F (37.8°C) or below 40°F (4.4°C). Check the location of your alarm (see " <b>Installation Locations</b> ").



	The device is clogged by dirt and dust.	Clean the device periodically (see <b>"Maintenance"</b> ).
Device failed to connect to the network.	The entered Wi-Fi name and/or password are wrong.	Enter the correct Wi-Fi name and password.
	The phone Bluetooth is not turned on.	Turn on the phone's Bluetooth.
	The device is not entering pairing mode.	Press and hold the Test/Silence button on the device for 5 seconds and its LED will flash blue to enter the pairing mode.
The app push notification is delayed or there are no push alerts.	The app push notification permission is disabled.	Turn on the push notification permission on the phone.
	The device is not within the network coverage of the router.	The distance between the device and the router should be within 170 ft (50 m). Please ensure that the device is always within the network coverage of the router.
	The network connection of the router and the mobile phone is abnormal.	Make sure the network connection of the router and the mobile phone is normal.
The app shows that the alarm is offline.	The battery runs out.	Replace the battery.
	The communication between the alarm and the router is blocked or the distance is too far.	Reduce the obstacles between the alarm and the router. The maximum distance between the alarm and the router is 170 ft (50 m) in an open environment.

	The network connection of the router and the mobile phone is abnormal.	Make sure the network connection of the router and the mobile phone is normal.
The device screen shows the concentration value, yet the app does not provide notifications or display the concentration value.	The carbon monoxide (CO) concentration value is currently below 100 ppm, and the alarm threshold time has not been reached yet.	Device won't send a "CO Alarm Precaution" alert for CO concentrations under 100 ppm to save power and avoid disturbances. App won't display values either. But if CO under 100 ppm lasts for a period of time and reaches alarm threshold, normal alarm notification is sent.
Device screen updates concentration value, but the app value remains unchanged.	Device is in the "CO Alarm Precaution" state, and concentration hasn't increased to higher level yet.	To conserve power, the app updates the concentration value only when it rises within a specific range (e.g., from 110 ppm to 220 ppm) during the "CO Alarm Precaution" state.
LED flashes yellow once every 60 seconds with 1 beep.	Low battery warning.	The battery is low. Push Test/Silence button once to silence for 10 hours. <b>Replace the battery immediately.</b>
LED flashes yellow 2 times every 60 seconds with 2 beeps.	Malfunction.	The alarm is malfunctioning. Please clean your alarm and see if it is working normally. If not, <b>replace the device immediately.</b>
LED flashes yellow 3 times every 60 seconds with 3 beeps.	End-of-life warning.	The maximum lifetime (10 years) is reached. Push the Test/Silence button once to silence for 22 hours. <b>Replace the alarm immediately.</b>

## FCC Statement

This equipment has been tested and found to comply with the limits for a Class B digital device, pursuant to Part 15 of the FCC Rules. These limits are designed to provide reasonable protection against harmful interference in a residential installation. This equipment generates uses and can radiate radio frequency energy and, if not installed and used in accordance with the instructions, may cause harmful interference to radio communications. However, there is no guarantee that interference will not occur in a particular installation. If this equipment does cause harmful interference to radio or television reception, which can be determined by turning the equipment off and on, the user is encouraged to try to correct the interference by one or more of the following measures:

- Reorient or relocate the receiving antenna.
- Increase the separation between the equipment and receiver.
- Connect the equipment into an outlet on a circuit different from that to which the receiver is connected.
- Consult the dealer or an experienced radio/TV technician for help.

This device complies with part 15 of the FCC Rules. Operation is subject to the following two conditions:

(1) This device may not cause harmful interference, and (2) this device must accept any interference received, including interference that may cause undesired operation.

Changes or modifications not expressly approved by the party responsible for compliance could void the user's authority to operate the equipment.

FCC Radiation Exposure Statement: The equipment complies with FCC Radiation exposure limits set forth for uncontrolled environment. This equipment should be installed and operated with minimum distance 20cm between the radiator and your body.

## Environmental Protection

Waste electrical products should not be disposed of with household waste. Please recycle where facilities exist. Check with your Local Authority or retailer for recycling advice.



## Manufacturer and Service Information

X-Sense Innovations Co., Ltd.

Address: B4-503, Kexing Science Park, 15 Keyuan Road, Shenzhen, 518057, CHINA

Email: support@x-sense.com