

**SBS50**

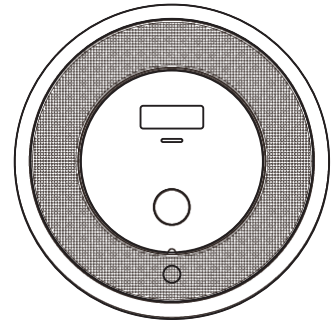

**XP0A-MR**

**Link+ Pro Combination Smoke and Carbon Monoxide Alarm with Base Station**

User Manual



## Introduction

All X-Sense combination smoke and carbon monoxide alarms conform with regulatory requirements, including **UL 217** and **UL 2034** standards and are designed to detect both smoke and carbon monoxide.

### **This alarm supports Link+ Pro. Please note the following:**

1. *Only devices that are advertised as supporting Link+ Pro can be connected to the app via the base station.*
2. *Link+ Pro supports both base station connection and a customizable wireless network as separate networks. You can only connect a device to one of them at a time. If you connect them to the base station, you'll receive app notifications but lose the customizable wireless network. Choosing the customizable wireless network means disconnecting from the base station and losing app notifications. Wireless interconnection is supported regardless of your choice.*
3. *This device can be interconnected with other Link+ series devices to create a customizable wireless network.*
4. *Switching between the base station and customizable wireless network is simple and can be done at any time by following the corresponding adding method.*
5. *Please note that the interlinked test function is not supported by the base station.*

## Product Overview

### **XP0A-MR Combination Alarm**

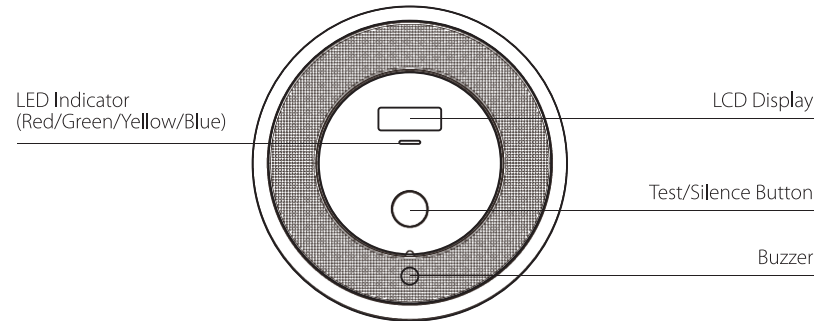

## SBS50 Base Station

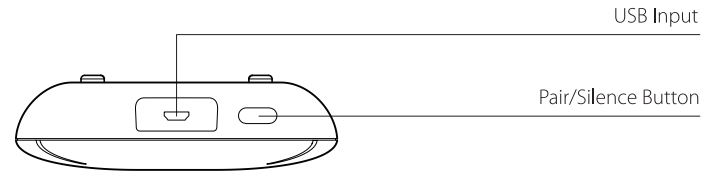
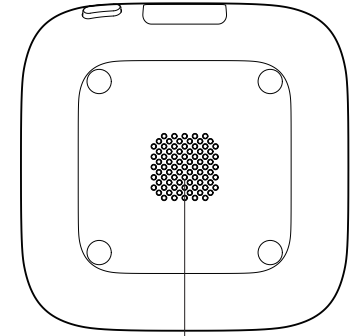
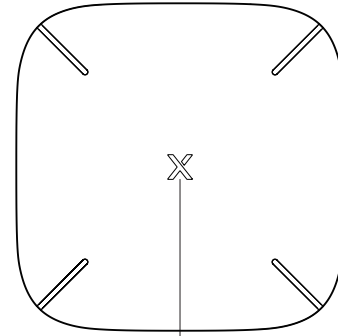
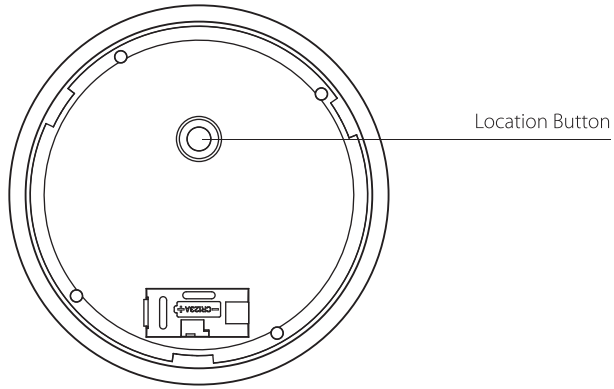

## Package Contents

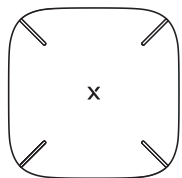

Base Station

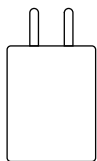

Power Adapter

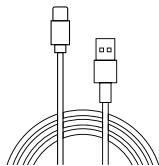

Power Cable

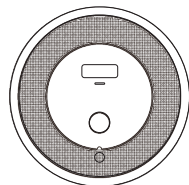

Alarm Unit  
(Pre-installed Battery)

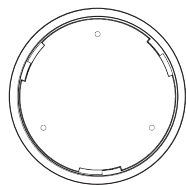

Mounting Bracket

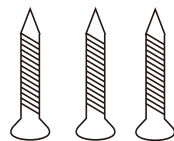

Screws

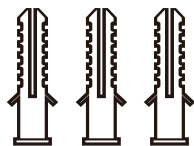

Anchor Plugs



User Manual



Battery (pre-installed)

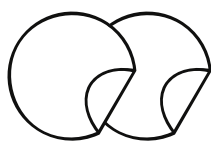

Carbon Monoxide  
Safety Stickers

## Safety Information

DANGERS, WARNINGS, AND CAUTIONS ALERT YOU TO IMPORTANT INSTALLATION AND OPERATING INSTRUCTIONS, OR POTENTIAL HAZARDS. PLEASE PAY ATTENTION TO THE SITUATIONS.

### ⚠ IMPORTANT

1. THIS DEVICE IS NOT DESIGNED FOR HEARING-IMPAIRED PEOPLE. USE OF ALCOHOL OR DRUGS MAY IMPAIR ONE'S ABILITY TO HEAR THE SMOKE ALARM.
2. FIRES IN CHIMNEYS, WALLS, ROOFS, OR BEHIND CLOSED DOORS MAY NOT BE DETECTED.
3. THIS DEVICE IS NOT INTENDED FOR DETECTING FLAMES, HEAT, CARBON MONOXIDE, OR OTHER HAZARDOUS GASES.

### ⚠ WARNING

1. NEVER IGNORE AN ALARM. FAILURE TO RESPOND CAN RESULT IN SERIOUS INJURY OR EVEN DEATH.
2. THE SILENCE FEATURE IS ONLY FOR YOUR CONVENIENCE AND WILL NOT CORRECT A PROBLEM. ALWAYS CHECK YOUR HOME FOR ANY POTENTIAL HAZARDS EVERY TIME AN ALARM SOUNDS.
3. TEST THIS SMOKE ALARM ONCE A WEEK. IF THE ALARM FAILS TO TEST CORRECTLY, REPLACE IT IMMEDIATELY! IF THE ALARM IS NOT WORKING PROPERLY, IT WILL NOT ALERT YOU TO A PROBLEM.

## Device Setup

### Download the X-Sense Home Security App



Download on the  
App Store



GET IT ON  
Google Play

*Make sure your smartphone supports iOS 11 and higher, or Android 8.0 and higher.*

To download the **X-Sense Home Security** App, scan the QR code or search for "**X-Sense Home Security**" in the Apple App Store or Google Play Store. Sign up with a valid email address. If you already have an account, make sure the app is updated to the latest version.

## Before connecting devices, make sure that:

1. You know your Wi-Fi network name and password.
2. You are connecting your device using a 2.4 GHz Wi-Fi network (incompatible with 5 GHz Wi-Fi network).
3. Make sure the Bluetooth on your phone is turned on.

**NOTE:** When the device is configured via Wi-Fi, make sure your mobile phone and devices are as close to the router as possible, which can speed up device configuration.

## Connecting the Base Station to the Network

1. Connect the base station to a power source with the power adapter.
2. Tap "⊕" in the app, select "Base Stations", select "Base Station (SBS50)" in the product list, and then you will see the "Scan QR Code" page. Scan the QR code on the bottom of the base station.
3. Enter a name for the base station. Select the home you created or create a new home for the base station, then select the room in which it is installed. If you create a new home, you will need to enter a name and select the country or region in which you live.
4. Press and hold the pair button of the base station for 5 seconds until the LED indicator flashes yellow rapidly, indicating that the base station is waiting to connect to the Wi-Fi.

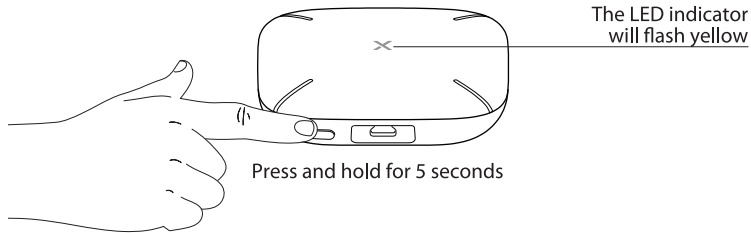

5. Tap "Operation confirmed" and tap "Next." The page will show "Searching for nearby Bluetooth devices."
6. Enter the correct Wi-Fi and password then tap "Next" to add the device. You will hear "Connecting to Wi-Fi."
7. After successfully connected, you will hear "Wi-Fi connected" and the "Device added" page will appear. The LED indicator will stay solid blue and you can find the base station in the device list.

## Connect the Link+ Pro Alarm to the Base Station

The Link+ Pro Alarm can be connected to the base station through the wireless network. When the alarm is connected to the base station, you can receive push notifications wherever you are to stay informed of the device status, and to silence an alarm from your smartphone.

**NOTE:** Before adding devices to the system, make sure the base station has been successfully added to the app.

1. Tap "⊕", select "Combination Smoke and CO Alarms", and then select "Link+ Pro Combination Alarm with Voice Alerts (XPOA-MR)" in the product list. Then, choose the installation location that matches the actual placement of the device. After that, tap "Next" to enter the next page.

**Choose the precise installation location for the alarm within the app. When an alarm is triggered, it will broadcast this designated location. That is to say, when danger occurs, the alarm will say "Warning. Smoke detected in Location. Evacuate." or "Warning. Carbon monoxide detected in Location. Move to fresh air."**

When connected to the base station, all devices wirelessly interconnect. If one, like XPOA-MR, triggers, others relay the exact location. For example, if named "Basement," "Kitchen," and "Office," when "Basement" detects smoke, all three announce "Warning! Smoke detected in Basement. Evacuate."

2. Follow the prompts on the page by pressing the test/silence button twice on the alarm. The device will say "Ready to connect" and the LED will flash blue rapidly, indicating that the device is waiting to connect to the Wi-Fi.
3. Tap "Next" to add the device. You will hear "Ready to add the device."
4. After successfully connected, the device will say "Connected." and the "Device added" page will appear. Then you can find the alarm in the device list.
5. If you want to add multiple devices into the system, please repeat the above steps.

**NOTE:** If not added to the network within 60 seconds, it says "Connection failed. Please try it again." It automatically exits configuration; repeat steps for re-entry.

## App Features

**Notifications:** You will receive push notifications on the app for smoke alarms, danger cleared, low battery, device malfunction, end of life, etc.

**Device Test:** Simply tap the Device Test button in the app to test whether the device is functioning properly.

**Device Sharing:** You can share the device with your family members and friends. They will receive app push notifications for alarms and have the ability to silence the device, view historical events, etc.

## Interconnect the Alarms Without Adding to the Base Station

If you don't want to add the alarms to the base station, you can connect the alarms using RF technology to create an interconnected alarm system. However, you will no longer be able to receive push notifications on your phone from the X-Sense Home Security app.

**NOTE:** The XPOA-MR alarms can be connected to the X-Sense Link+ Pro and Link+ alarms using wireless interconnection without being connected to the base station.

## Powering On Before Setting the Location

For initial use, remove the battery insulation film to power on. The device says "Hello from X-Sense" and prompts location selection. After battery replacement with a set location, it says "Press the Test/Silence button to test." During the voice report, pressing the test/silence button won't prompt a response.

## Setting the Location

Please follow the steps below to set the device location so that it is accurate to the actual installation location.

When danger occurs, the alarm will say "Warning! Smoke detected in location. Evacuate." or "Warning! Carbon monoxide detected in location. Move to fresh air."

In an interlinked network, when one XP0A-MR is triggered, all devices report the same location. For instance, if device A in the basement is triggered, devices B and C, set to kitchen and office, will also announce "Warning! Smoke detected in Basement. Evacuate."

1. After powering on, press the Location button. If not set, it prompts to select a location; otherwise, it offers to change it.
2. Press Location again, and it guides through locations. Quickly press twice for the last location; hold to save.
3. After step 2, press Location again. The device will say "Entryway."
4. In the location list, press for the next location, press twice for the last, and hold to save.
5. The location list repeats; press when it says "No location" to hear "Entryway" again.
6. When saved, it says "Location saved."
7. There's a 1-minute timeout for setting; it exits to standby mode, saying "Unable to set the location. Please try again."

## For devices connected to the base station:

1. Regardless of whether the device has been connected to the network, you can set and modify the location through the location button on the back of the device.
2. If the device, not yet added to the base station, is set the location using the location button, when added to the app, the location set in the app will override the device-side location.
3. If you've already added the device to the app and then change its location using the location button, the app will update to show the new location.
4. When you add the device to the app, you have the option to set its location. Once the adding process is finished, you can also change the device's location if needed.

## Location List

|   |                |
|---|----------------|
| 1 | Entryway       |
| 2 | Basement       |
| 3 | Living room    |
| 4 | Dining room    |
| 5 | Kitchen        |
| 6 | Hallway        |
| 7 | Master bedroom |
| 8 | Kids room      |
| 9 | Guest room     |

|    |              |
|----|--------------|
| 10 | Den          |
| 11 | Family room  |
| 12 | Study        |
| 13 | Office       |
| 14 | Workshop     |
| 15 | Utility room |
| 16 | Attic        |
| 17 | No location  |

## How to Set Up and Interconnect Wireless Alarms

X-Sense alarms can connect wirelessly to form a network. When one alarm goes off, all others do too. These alarms include smoke, carbon monoxide, and combined detectors. They only link with other X-Sense alarms, not different brands. If you bought a multi-pack without a base station, they're already linked. Otherwise, connect each device one by one. For multiple packs, pick one as the base and link the others to it.

**NOTE:** The following instructions regarding wireless interconnection are applicable to the X-Sense Link<sup>®</sup> Pro and Link<sup>®</sup> wireless interlinked alarms only.

## How to Interconnect

1. Work with only two units at a time, ensuring they are both turned on for successful connection.
2. Press the test/silence button on one unit four times; it will enter pairing mode. Press the other unit's button twice; it will be ready to connect.
3. Upon successful search and group creation, both units will confirm connection, beep once, and exit pairing mode.
4. To add a third alarm, repeat step 2 with any of the connected units and the new device.
5. For additional units, repeat step 4. **NOTE:** For XH02-M, use the pairing button on the back, not the front test/silence button.
6. Test alarms following the steps in the "Alarm Test" section.

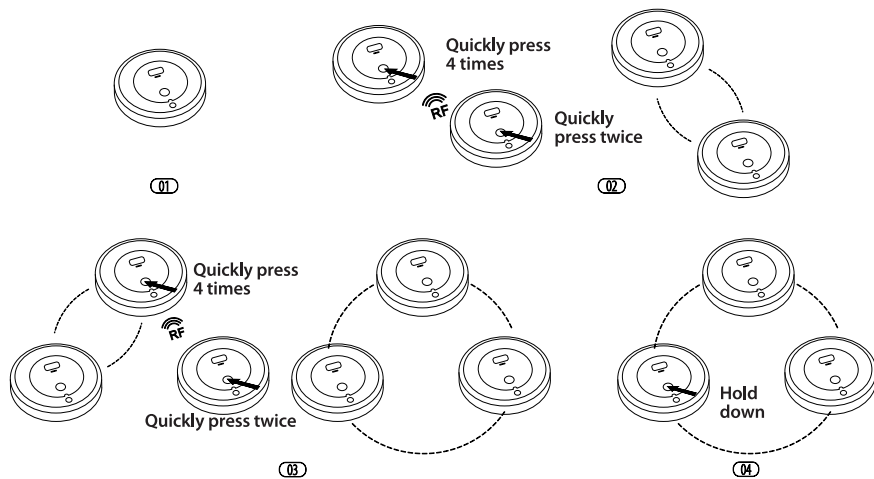

- NOTES**
1. The alarm enters 60-second searching/pairing mode with a flashing red LED. Repeat step 2 after 60 seconds for connection. Press Test/Silence once to exit pairing mode and return to normal status.
  2. Test all wireless alarms for interconnection before installation.
  3. Maximum 24 wireless alarms can interconnect on the same network.
  4. Interconnect only with the same model or other X-Sense Link<sup>®</sup> Pro and Link<sup>®</sup> wireless alarms.

## How to Disconnect

Quickly press Test/Silence button 4 times to initiate search. Hold until it says “Disconnected, standalone device now” and beeps to disconnect. Afterward, reconnect to the same or a new network.

**NOTE:** For multi-packs without a base station, they're pre-linked; disconnect each alarm individually to form a new network.

## Alarm Test

|                   | Test a Single Alarm   | Test All Interconnected Alarms   |
|-------------------|---|--|
| <b>Action</b>     | <ul style="list-style-type: none"> <li>• Press the test/silence button.</li> <li>• Tap the Device Test button in the app.</li> </ul>  | Hold down the test/silence button.   |
| <b>Indication</b> | <ul style="list-style-type: none"> <li>• The alarm will emit 2 sets of 3 long beeps followed by 2 sets of 4 quick beeps. The device will announce a voice, paired with the LED flashing red.</li> <li>• For devices connected to the base station, a push notification will be sent to your smartphone.</li> <li>• Then the alarm will automatically enter standby mode.</li> </ul> | <ul style="list-style-type: none"> <li>• The initiating unit will announce a voice, paired with the LED flashing red.</li> <li>• Other interconnected alarms in the network will receive the test signal after 5 seconds. They will announce a voice, and beep continuously with the LED flashing red and green successively.</li> <li>• The testing should be completed within 3 minutes.</li> <li>• After testing, the units will automatically enter standby mode.</li> </ul> |

- NOTE**
1. The devices connected to the base station can only be tested individually. The interconnected devices that are not connected to the base station can be tested by holding down the test/silence button on one of the devices.
  2. Pressing the Test/Silence button is the recommended testing method, which can comprehensively check the sensors, electronic circuits, buzzer, battery, and other components in the alarm. Never use an open flame to test this device.

## Installation Positioning

**NOTE:** Before installation, it is recommended to test the interconnected alarms in the rooms where you intend to install them to ensure that they are within transmission range and that nothing will interfere with their communication.

## Installation Locations

1. Prioritize the installation of an alarm in the bedroom and walkways, and make sure you can hear the alarm from all sleeping areas. In a home with several bedrooms, install an alarm in every bedroom. If you install only one smoke alarm in your home, install the alarm near to all bedrooms where possible, and not in a basement or furnace room.
2. Install an alarm above the stairway and on every floor of the house.
3. Smoke, heat and anything burning will spread horizontally after rising to the ceiling, so install the alarm in the middle of the ceiling where possible. Ensure the alarm is within working distance of all corners of the room.
4. If an alarm cannot be installed in the middle of a ceiling, install at a distance of 20 inches (50 cm) away from the corners of the room.
5. If an alarm is installed on a wall, it should be at a distance of 4-12 inches (10-30 cm) below the ceiling.
6. If the length of a room or hall is beyond 30 feet (900 cm), you will need to install several alarms in the same room.
7. When the wall or ceiling is angled, the alarm needs to be installed within 3 feet (90 cm) of the highest wall or ceiling point (measured horizontally) in the room.

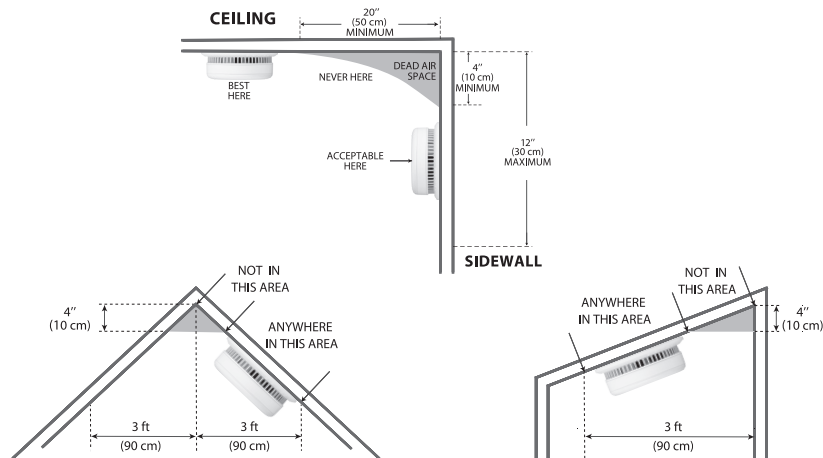

8. In multi-level houses or apartments, install at least one wireless alarm on each level and keep them installed in a straight vertical line (see diagram) with as few obstacles between each of the interconnected alarms as possible to ensure optimal signal transmission.

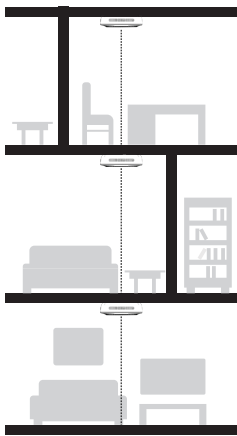

### Locations to Avoid:

1. Near large metal surfaces and/or bundles of wire.
2. Near fluorescent lights, amateur radios, electrical equipment, or other devices that may transmit an RF signal, as electronic noise may cause nuisance alarms.

### Recommended Placement

#### **⚠ WARNING**

1. THIS ALARM SHOULD BE INSTALLED BY A COMPETENT PERSON.
2. INSTALLATION OF THE ALARM SHOULD NOT BE USED AS A SUBSTITUTE FOR PROPER INSTALLATION, USE AND MAINTENANCE OF FUEL BURNING APPLIANCES INCLUDING APPROPRIATE VENTILATION AND EXHAUST SYSTEMS.

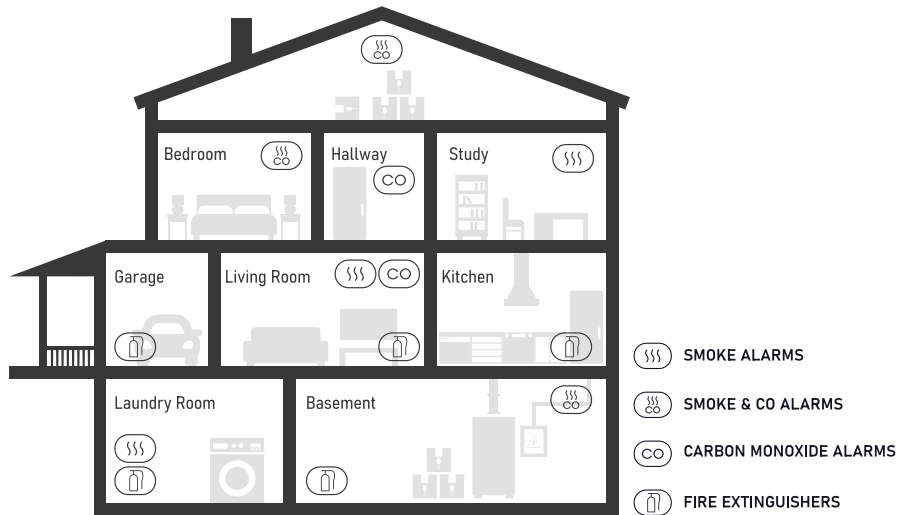

### How to Install This Alarm

#### **⚠ IMPORTANT**

THIS COMBINATION SMOKE/CO ALARM IS DESIGNED TO BE MOUNTED ON THE CEILING OR WALL.

#### **⚠ WARNING**

FAILURE TO PROPERLY INSTALL AND ACTIVATE THIS ALARM WILL PREVENT PROPER OPERATION OF THE ALARM AND WILL PREVENT ITS RESPONSE TO FIRE HAZARDS OR CO.

### Locations to Avoid

**WARNING:** This product is intended for use in ordinary indoor locations of family living units. It is not designed to measure CO levels in compliance with the Occupational Safety and Health Administration (OSHA) commercial or industrial standards.



1. Do not install in garages, kitchens, furnace rooms or bathrooms! Do not install within 5 ft (1.5 m) of cooking appliances.
2. Do not install within 3 ft (0.9 m) of the following: The door to a kitchen, or a bathroom that contains a tub or shower, forced air supply ducts used for heating or cooling, ceiling or whole house ventilating fans, or other high air flow areas. Avoid excessively dusty, dirty or greasy areas. Dust, grease or household chemicals can contaminate the alarm's sensors, causing the alarm to not operate properly.
3. Place the alarm where drapes or other objects will not block the sensors. Smoke and CO must be able to reach the sensors to accurately detect these conditions. Do not install in peaks of vaulted ceilings, "A" frame ceilings or gabled roofs. Keep out of damp and humid areas.
4. Install at least one (1) foot away from fluorescent lights, as electronic noise may cause nuisance alarms.
5. Do not place in direct sunlight and keep out of insect-infested areas. Extreme temperatures will affect the sensitivity of the smoke/CO alarm.
6. Do not install in areas where the temperature is colder than 40°F (4.4°C) or hotter than 100°F (37.8°C), such as garages and unfinished attics.
7. Do not install in areas where the relative humidity (RH) is above 85% or below 10%. Place away from doors and windows that open to the outside.
8. Smoke alarms are not to be used with detector guards unless the combination (alarm and guard) has been evaluated and found suitable for that purpose.

## Mounting Steps

**NOTE:** Before installation, it is recommended to test the interconnected alarms in the rooms where you intend to install them to ensure they are within transmission range and that nothing will interfere with their communication.

1. Drill three Ø 6.0 mm holes in the wall or ceiling, then insert three plastic anchor plugs into the holes with a hammer.
2. Attach the mounting bracket to the surface of the wall or ceiling with three screws and mount the alarm into the bracket by pushing them together and twisting the unit clockwise.
3. Test the unit by using the Test/Silence button. Ensure the unit sounds in an alarm pattern.

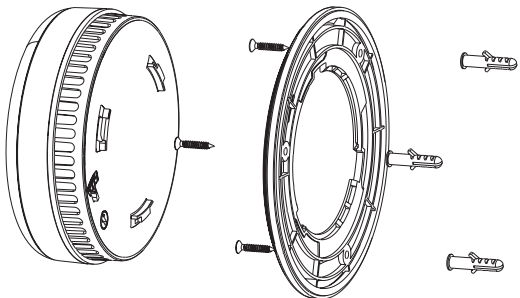

## Peak CO Concentration Memory and Reset

The peak CO concentration feature is helpful in identifying if there have been any dangerous CO readings since a peak CO concentration reset.

Each time you push the test button, the LCD displays the peak CO concentration recorded since the previous reset. The peak CO concentration will be displayed for 5 seconds, and then the device will enter standby mode. In the example, 300 ppm was the maximum CO concentration recorded since the unit was last reset.



**Peak CO Concentration Reset:** During the 5 seconds when the LCD displays the peak CO concentration, press and hold the test button for 3 seconds, the device will beep, the LED will flash green, and the peak CO concentration will be reset with LCD displaying "0."

### NOTE

1. If the carbon monoxide concentration is lower than 30 ppm, it will not be recorded in the peak CO concentration.
2. The peak CO record and reset function are only supported on the device itself and are not controllable through the app.

## Alarm Mode

### For devices connected to the base station:

- Triggered alarms show in-app messages and push notifications.
- All system-connected devices and the base station sound alarms together.
- Base station auto-mutes after 10 minutes but system devices continue.
- If the base station powers off, interconnected devices still alarm.
- Adjust base station volume and mute alarms through the app. Receive push notification if smoke or CO levels drops below alarm threshold.
  1. If one XP0A-MR alarm detects smoke, it beeps 3 times every 4 seconds with a red flashing LED. Other units follow, beeping and flashing red/green.
  2. If one CO alarm detects carbon monoxide, it beeps 4 times every 5.8 seconds with a red flashing LED. Other units follow, beeping and flashing red/green.

For more details, please see "LED Indicator and Audible Alarm".

## NOTES

- Triggering one unit activates others; smoke alarm takes priority over CO alarm.
- If the initiating alarm has location support, others provide location information; otherwise, location-support alarms relay voice alerts without specifying location.
- The alarm extends the wireless network for wide detection coverage with a relay function.

## Silence Mode

Silence the device by pressing the test/silence button or using the app. During an alarm, pressing it triggers a voice confirmation, sends a push notification, and enters silence mode for 9 minutes. Afterward, the LED flashes green 3 times, and the device returns to normal mode.

**NOTE:** If the smoke concentration is too high, the device cannot be silenced.

### Connected to Base Station:

- Press base station Silence or app button to silence passive devices, then test/silence on the initiating alarm.
- Use the app Locate to find the initiating alarm; others stop alarming.

### Not Connected to Base Station:

- Press test/silence on one device to silence passives; silencing the initiator silences all.
- Initiating alarm reports "Smoke/CO alarm silenced," others don't.

## NOTES

1. Silence all interconnected units by pressing Test/Silence on one unit. If any unit continues alarming, the initiating unit must also have its Test/Silence button pressed.
2. During the 9-minute silence, the initiating unit can't trigger again, but other units can if danger is detected.

## Battery Replacement

### Low Battery

The LED flashes yellow once every 60 seconds. For the first 15 minutes, the device will give a verbal warning every 60 seconds. After 15 minutes, the device will stop the voice alert and beep once every 60 seconds.

(If you press the test button when there is low battery, the low battery signal will temporarily cease for 10 hours.)

### Replacing Battery

1. To replace the battery, detach the smoke alarm from the mounting bracket by twisting counterclockwise.
2. Remove the battery, and then install a new battery, matching the correct polarity markings.
3. Test the alarm, and then mount the alarm onto the mounting bracket by twisting clockwise to lock the alarm.

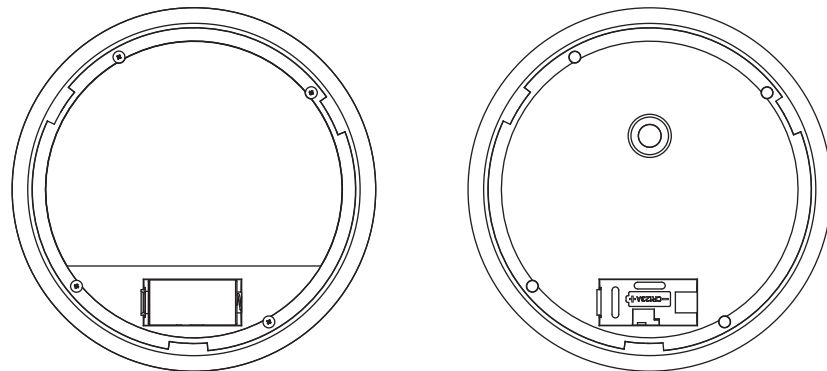



### End of Life



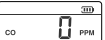
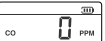
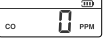
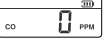

When the device reaches its end of life, the LED will flash yellow 3 times every 60 seconds. For the first 15 minutes, the device will give a verbal warning. After 15 minutes, the device will stop the voice alert and beep 3 times every 60 seconds. This end-of-life signal can be temporarily silenced for 22 hours by pressing the test button.

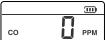
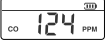
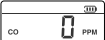

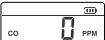
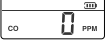
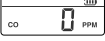
The end-of-life silence feature can only be used for a total of 30 days. After 30 days, the end-of-life signal cannot be silenced.

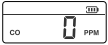
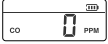
## LED Indicator and Voice Guide

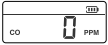
| Mode                        | LCD Display   | LED Indicator   | Voice Guide                                    | Remarks   |  |
|-----------------------------|---|---|--|---|--|
| Powering On                 |  | Runs through 8 cycles (yellow/green/red) in sequence. | First-time use.                                | Remove the battery insulating film from the battery compartment to turn on the device.<br>When the LED stops flashing, the voice guide will give instructions.  |  |
|                             |   |   | Batteries are replaced.                        |   | "Hello from X-Sense."<br><br>"Location not set. Press the Location button to select a location."<br><br>"Press the Test/Silence button to test."             |
|                             |   |   | Location not set.                              |   | "Location not set. Press the Location button again to select a location."  |
| Setting Location            |  | Flashes red once every 3 seconds.                     | Location set.                                  | Press down the Location Button. After the voice guide has ended, the LED will flash red every 3 seconds to indicate that the device is currently in the location setting mode, and the LED will continue to flash until it returns to standby mode. |  |
|                             |   |   | Location not set.                              |   | "Location not set. Press the Location button again to select a location."<br><br>"Location set. Press the Location button again to change the set location." |
| Wi-Fi Pairing Mode          |  | Flashes blue rapidly.                                 | Transmission mode.<br>Ready to connect.        |   |  |
| Inter-Device Pairing Status |  | Flashes blue slowly.                                  | Reception mode.<br>Searching for a new device. |   |  |
|                             |   |   | Transmission mode.<br>Ready to connect.        |   |  |
| Standby Mode                |  | Flashes green once every 60 seconds.                  | None.  | None.   |  |

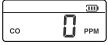
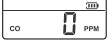
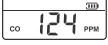
|   |   |   |  |   |   |
|---|---|---|--|---|---|
| Alarm Mode  | Unit detected smoke and initiated an alarm.   |   | Flashes red 3 times every 4 seconds.   | "Warning. Smoke detected in <u>location</u> . Evacuate."  | Dangerous smoke concentration is detected. Open nearby windows and doors, and immediately move to fresh air.                                |
|   | Unit detected CO and initiated an alarm.  |  | A CO concentration ranging from 30 to 999 ppm has been present for a certain time period. The LED indicator flashes red 4 times every 5.8 seconds. | "Warning. Carbon monoxide detected in <u>location</u> . Move to fresh air."   | Dangerous CO concentration is detected, and has reached the alarm status. Open nearby windows and doors, and immediately move to fresh air. |
|   | Smoke/CO concentration level drops.   |  | Flashes green once every second for 5 seconds.   | "Danger cleared."   | Alarm cancellation: when the smoke/CO concentration level drops below the alarm threshold, the alarm signal will stop.                      |
|   | All other interconnected units in the network.                                      |  | Flashes red and green 3 times sequentially every 4 seconds.  | "Warning. Smoke detected in <u>location</u> . Evacuate."  | Dangerous smoke concentration is detected by the initiating unit in the network. Please find the initiating unit and take action.           |
| The LED flashes red 4 times, then the LED flashes green once every 5.8 seconds. |   |   | "Warning. Carbon monoxide detected in <u>location</u> . Move to fresh air."  | Dangerous CO concentration is detected by the initiating unit, and has reached the alarm status. Please find the initiating unit and take action.   |   |
| Test Mode   | Test a single unit.   |  | 2 sets of 3 red flashes followed by 2 sets of 4 red flashes.   | "This is only a test. The alarm will sound loudly. You can press the Test/Silence button to cancel the test. Testing the smoke sensor. Testing the carbon monoxide sensor. The test is finished." | Short press the Test/Silence button.  |
|   |   |   | "Test canceled."   | Exit the test mode  |   |
|   |  | "Normal working status."  | Normal functioning.  |   |   |
|   |  | "Caution. Low battery. Replace the battery now."                                    | Low battery  |   |   |

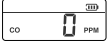
|                                |   |  |   |  |
|--------------------------------|---|--|---|--|
|                                |   |  | "Caution. Smoke sensor malfunction. Replace the device now."  | Smoke sensor malfunction. Please clean your alarm and see if it is working normally. If the device continues to indicate a malfunction, it must be replaced immediately. |
|                                |  |  | "Caution. Carbon monoxide sensor malfunction. Replace the device now."  | Carbon monoxide sensor malfunction. Replace the device immediately.  |
| Test all interconnected units. |  | Flashes red rapidly.                     | "This is a test for all units. Please confirm if other units receive this test signal from <u>Location</u> . To cancel, release the Test/Silence button." | Initiating alarm.<br>Hold down the Test/Silence button on one unit in the network.   |
|                                |  | Flashes red and green sequentially.      | "Test signal received from <u>Location</u> , not a real alarm."   | Other interconnected alarms in the network.  |
|                                |  | Flashes red and green sequentially.      | "Test signal received, not a real alarm."   | The initiating device does not interconnected voice test, (such as XS01-M), while the passive device is XP0A-MR.   |
| Silence Mode                   |  | Flashes red 3 times every 4 seconds.     | "Smoke alarm silenced."   | Smoke silence mode: After 9 minutes, the unit will exit silence mode.  |
|                                |  |  | "This alarm cannot be silenced. Smoke levels too high."   | When the smoke concentration is too high, the sound cannot be muted by pressing the test button.   |
|                                |  | Flashes red 4 times every 5.8 seconds.   | "Carbon monoxide alarm silenced."   | CO silence mode: After 9 minutes, the unit will exit silence mode.   |
|                                |   | Flashes yellow once every 60 seconds.    | "Temporarily silenced."   | Silence mode during low battery: After 10 hours, the unit will exit silence mode.  |
|                                |   | Flashes yellow 3 times every 60 seconds. | "Temporarily silenced."   | Silence mode during the end of cycle: After 22 hours, the unit will exit silence mode.   |
|                                |   | Flashes green 3 times.                   | None.   | After 9 minutes of silence, it will automatically exit silent mode.  |

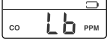
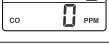
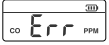
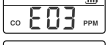
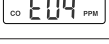
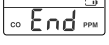
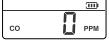
|                                  |   |  |   |  |
|----------------------------------|---|--|---|--|
| Peak CO Concentration Indication |   | Flashes green once.                      | 1 beep.   |  |
| Peak CO Concentration Reset      | <br>  | Flashes green once.                      | 1 beep.   | The peak CO concentration will be reset with LCD displaying "0."   |
| Low Battery                      | <br>  | Flashes yellow once every 60 seconds.    | "Caution. Low battery. Replace the battery now."                                  | Replace the unit immediately.  |
| Fault                            | <br><br> | Flashes yellow 2 times every 60 seconds. | "Caution. Smoke sensor malfunction. Replace the device now."                      | Smoke sensor malfunction. Please clean your alarm and see if it is working normally. If the device continues to indicate a malfunction, it must be replaced immediately. |
|                                  |   |  | "Caution. Carbon monoxide sensor malfunction. Replace the device now."            | Carbon monoxide sensor malfunction. Replace the device immediately.  |
| End of Life                      |    | Flashes yellow 3 times every 60 seconds. | "Caution. The alarm has reached the end of its lifetime. Replace the device now." | Replace the unit immediately.  |
| Exit the Network                 |    |  | "Disconnected, standalone device now."  | Already exited the network, it is an independent device.   |

## Technical Specifications

### Specifications of Base Station

|                                 |   |
|---------------------------------|---|
| Model                           | SBS50   |
| Power Supply                    | Input: 100–240 V AC 50/60 Hz; Output: 5.0 V=1.0 A   |
| Operating Temperature           | 40–100°F (4.4–37.8°C)   |
| Operating Relative Humidity     | 0–85% RH (non-condensing)   |
| Alarm Volume                    | 100 dB  |
| App                             | X-Sense Home Security (both Android and iOS supported)  |
| Wi-Fi Frequency                 | 2400–2483.5 MHz (incompatible with 5 GHz Wi-Fi network)   |
| Maximum Number of Allowed Units | 50 devices can be added to the SBS50 base station including smoke alarms, carbon monoxide alarms and other smart devices. |
| Wi-Fi Transmission Range        | 170 ft (50 m)   |
| Wireless Protocol               | IEEE 802.11b/g/n  |
| FCC ID                          | 2AU4DDBQ  |
| Transmit Power                  | 10 mW e.r.p.  |

### LED Indicator of Base Station

| Status                         | LED Indicator                 |
|--------------------------------|-------------------------------|
| Powering On                    | The LED flashes red once.     |
| Wi-Fi Connected Successfully   | The LED remains solid blue.   |
| Failed to Connect to the Wi-Fi | The LED remains solid yellow. |
| Wi-Fi Pairing Mode             | The LED flashes yellow.       |
| Alarm                          | The LED flashes red.          |

### Specifications of Alarm

|                  |   |
|------------------|---|
| Power Supply     | CR123A lithium battery (replaceable)  |
| Battery Life     | 5 years (test once a week) (wireless interconnected network)<br>3–5 years (test once a week) (when connected to base station) |
| Sensor Type      | Smoke: Photoelectric<br>CO: Electrochemical   |
| Safety Standards | UL 217 and UL 2034  |

|  |  |
|--|--|
| CO Sensitivity                         | 70 ppm: 60–240 minutes   |
|  | 150 ppm: 10–50 minutes   |
|  | 400 ppm: 4–15 minutes  |
| Operating Temperature                  | 40–100°F (4.4–37.8°C)  |
| Operating Relative Humidity            | 10%–85% RH (non-condensing)                                      |
| Alarm Loudness                         | ≥ 85 dB at 10 ft (3 m) @ 3.2 ± 0.3 kHz pulsing alarm             |
| Silence Duration                       | ≤ 9 minutes  |
| Operating Frequency                    | 915.275 MHz  |
| Maximum Number of Interconnected Units | 24 wireless units (only compatible with X-Sense wireless alarms) |
| Transmission Range                     | Over 1,700 ft (500 m) in open air                                |
| Transmit Power                         | 10 mW e.r.p.   |

#### NOTE:

1. Battery life is calculated on the current ratings in the standby mode with weekly testings. If its operation mode changes to an alarming condition, the battery life will be decreased accordingly.
2. The alarm functions between 40 and 100°F (4.4 and 37.8°C). Prolonged exposure to temperatures outside of this range can reduce battery life and affect accuracy. We do not recommend operating the device outside of this range.

## Maintenance

To keep your alarm in good working order, follow these simple steps:

1. Verify the unit's alarm sound and indicator are working properly by testing the unit once a week.
2. As a minimum your alarm should be cleaned once every 3 months: Remove the unit from the ceiling and clean the alarm cover and vents with your vacuum cleaner fitted with the soft brush attachment to remove dust and dirt.
3. Never use detergents or other solvents to clean the unit.
4. Avoid spraying air fresheners, hair spray or other aerosols near the alarm.
5. Do not paint the unit. Paint will seal the vents and interfere with the sensor's ability to detect fire or CO.
6. Never attempt to disassemble the unit or clean inside. Doing so will void your warranty.
7. When removed, place the alarm back in its proper location as soon as possible, to assure continuous protection from fire or carbon monoxide.
8. When household cleaning supplies or similar contaminants are used, the area should be ventilated.

## Troubleshooting

| Problems   | Cause   | Solution  |
|--|---|---|
| The device is not triggered when it is tested with smoke.  | The device is not turned on.                                      | Make sure the battery insulating film is removed. If the battery runs out, please replace the battery.  |
|  | The smoke is not reaching the sensor properly.                    | The smoke needs to enter the smoke sensor from the air inlets on the side to trigger the device.  |
|  | The time duration is insufficient for the device to detect smoke. | Continuous smoke is necessary for the device to be triggered. When smoke reaches the smoke sensor, the device will be triggered in about 20 seconds.  |
|  | Insufficient smoke concentration.                                 | This product utilizes a photoelectric sensor, requiring sufficient smoke concentration for detection. Higher smoke levels lead to faster alarm response. Avoid using an open flame for testing.   |
| The alarm does not sound during a test.  | The device does not turn on.                                      | Remove the battery insulating film from the battery compartment to turn on the device. If the battery runs out, please replace the battery.   |
|  | You don't push the Test/Silence button firmly.                    | Make sure you have pushed the Test/Silence button firmly.   |
| When the test button is held down, only one alarm sounds and the other interconnected alarms do not respond. |   | <ul style="list-style-type: none"> <li>When connected to a base station, holding down the test button only tests a single device.</li> <li>When connected to a wireless interconnected network, holding down the test button will test all devices in the network.</li> <li>When exited from the wireless interconnected network, holding down the test button only tests a single device.</li> <li>A short press on the test button will always test a single device.</li> </ul> |
| It is unclear how to judge which alarm is triggered first.   | Connecting to the base station.                                   | View through the app; only the initiating alarm will be displayed as being triggered, and the other alarms will not.  |
|  |   | Press the app's Locate button in alarming mode to mute the base station and all passive devices, leaving only the initiating device alarming.   |
|  |   | In the alarming mode, press the test/silence button on any of the devices. If all other alarms are muted, the device you pressed is the source alarm, if not, then the source alarm is the one you will hear continuing to alarm. You need to press the test/silence button to silence the initiating alarm.  |
|  |   | Pressing the base station button can mute the base station and all devices. The initiating alarm flashes red, and the other alarms alternate flashing red and green.  |

|   |   |  |
|---|---|--|
|   | Wireless interconnected network.                  | In the alarming mode, press the test/silence button on any of the devices. If all other alarms are muted, the device you pressed is the source alarm, if not, then the source alarm is the one you will hear continuing to alarm. You need to press the test/silence button to silence the initiating alarm.   |
| False alarms are triggered intermittently when residents are cooking, taking showers, etc.                              | The device is improperly installed.               | Install the device far away from kitchen appliances, dusty places, shower areas, and locations where the temperature is over 100°F (37.8°C) or below 40°F (4.4°C). Check the location of your alarm (see <b>"Installation Positioning"</b> ).  |
|   | The device is clogged by dirt and dust.           | Clean the device periodically (see <b>"Maintenance"</b> ).   |
| When an alarm sounds, the voice does not announce the location, but only announces "Warning! Smoke detected. Evacuate." | The initiating alarm does not support location.   | If the initiating alarm is a voice alarm with location support (such as XP0A-MR), the other interconnected voice alarms with location support will also provide location information. However, if the initiating alarm is without location support (such as XS01-M), the other interconnected voice alarms with location support (such as XP0A-MR) will relay the voice alert without specifying the location. |
| The previous set location is forgotten.   | None.   | Go to the device page in the app, where you will find the location displayed in the details.   |
|   |   | Remove the device from the mounting bracket and press the Location button on the back. Then the device will report the current location. If you need to reset the location, press the Location button again, and follow the instructions and voice prompts.  |
| The base station failed to connect to the network.  | The entered Wi-Fi name and/or password are wrong. | Enter the correct Wi-Fi name and password.   |
|   | The phone Bluetooth is not turned on.             | Turn on the phone's Bluetooth.   |
|   | The base station is not entering pairing mode.    | Press and hold the Pair button on the base station for 5 seconds and the LED will flash yellow while entering pairing mode.  |
| The alarm cannot be added to the base station.  | The alarm did not enter pairing mode.             | Quickly press the pairing button twice on the alarm until it flashes blue rapidly, indicating it has entered pairing mode.   |
| The alarm volume of the base station is low.  | The alarm sound is set to low.                    | Go to "Base Station Alarm Volume" in the "Sound Settings" option to adjust the alarm sound.  |
| The app push notification is delayed or there are no push alerts.   | The app push notification permission is disabled. | Turn on the push notification permission on the phone.   |

|   |   |   |
|---|---|---|
|   | The base station is not within the network coverage of the router.  | The distance between the base station and the router should be within 170 ft (50 m). Please ensure that the base station is always within the network coverage of the router.   |
|   | The communication between the alarm and base station is not stable or they are too far apart.                                   | Reduce the obstacles between the alarm and base station. The maximum distance between the alarm and the base station in an open environment is 1,700 ft (500 m).  |
|   | The network connection of the router and the mobile phone is abnormal.  | Make sure the network connection of the router and the mobile phone is working normally.  |
| App prompts operation failure.  | The battery ran out.  | Replace the battery.  |
|   | The base station is not within the network coverage of the router.  | The distance between the base station and the router should be within 170 ft (50 m). Please ensure that the base station is always within the network coverage of the router.   |
|   | The communication between the alarm and base station is not stable or they are too far apart.                                   | Reduce the obstacles between the alarm and base station. The maximum distance between them in an open environment is 1,700 ft (500 m).  |
|   | The network connection of the router and the mobile phone is abnormal.  | Make sure the network connection of the router and the mobile phone is working normally.  |
| The app shows that the base station is offline.   | The base station's Wi-Fi connection is disconnected.  | Make sure that the router network connected to the base station is working normally.  |
|   | The base station is powered off.  | Check that the base station is properly connected to the power supply.  |
| The app shows that the alarm is offline.  | The communication between the alarm and the base station is blocked or the distance is too far.                                 | Reduce the obstacles between the alarm and the base station. The maximum distance between them is 1,700 ft (500 m) in an open environment.  |
|   | The battery ran out.  | Replace the battery.  |
| The device screen shows the concentration value, yet the app does not provide notifications or display the concentration value. | The carbon monoxide (CO) concentration value is currently below 100 ppm, and the alarm threshold time has not been reached yet. | Device won't send a "CO Alarm Precaution" alert for CO concentrations under 100 ppm to save power and avoid disturbances. App won't display values either. But if CO under 100 ppm lasts for a period of time and reaches alarm threshold, normal alarm notification is sent. |
| The LED flashes yellow once every 60 seconds with 1 beep and voice alert.   | Low battery.  | The battery is low. Push the Test/Silence button once to silence for 10 hours. <b>Replace the battery immediately.</b>  |

|   |              |  |
|---|--------------|--|
| The LED flashes yellow 2 times every 60 seconds with 2 beeps and voice alert. | Malfunction. | If there is a smoke or CO sensor malfunction prompt, follow the instructions in the manual to clean the device and confirm if normal operation is restored. If not, <b>replace the device immediately.</b> |
| The LED flashes yellow 3 times every 60 seconds with 3 beeps and voice alert. | End of life. | The maximum lifetime is reached. Push Test/Silence button once to silence for 22 hours. <b>Replace the alarm immediately.</b>  |

## What You Need to Know About CO

CO cannot be seen, smelled or tasted and can be fatal. The build-up of CO in the blood is called the carboxyhemoglobin (COHb) level and interferes with the body's ability to supply itself with oxygen. Depending on the concentration, CO can kill in minutes. The most common sources of CO are malfunctioning gas appliance used for heating and cooking, vehicles running in an attached garage, blocked chimneys or flues, portable fuel burning heaters, fireplaces, fuel powered tools and operating a grill in an enclosed space.

Indications of carbon monoxide poisoning include symptoms similar to the flu, but with no fever. Other symptoms include dizziness, fatigue, weakness, headache, nausea, vomiting, sleepiness and confusion. Everyone is susceptible to the danger of CO, but experts agree that unborn babies, small children, pregnant women, senior citizens and people with heart or respiratory problems are at the highest risk for serious injury or death. Every year a qualified technician should inspect and clean your heating system, vents, chimney, and flues.

The following symptoms are related to carbon monoxide poisoning and should be discussed with all members of the household:

**Mild exposure:** Slight headache, nausea, vomiting, fatigue (often described as "flu-like" symptoms).

**Medium exposure:** Severe throbbing headache, drowsiness, fast heart rate.

**Extreme exposure:** Unconsciousness, cardiorespiratory failure, death.

The above levels of exposure relate to healthy adults. Levels differ for those at high risk. Exposure to high levels of carbon monoxide can be fatal or cause permanent damage and disabilities. Many cases of reported carbon monoxide poisoning indicate that while victims are aware they are not well, they become so disoriented they are unable to save themselves by either exiting the building, or calling for assistance. Also, young children and household pets may be the first affected. Familiarization with the effects of each level is important.

## Following Conditions Can Result in Transient CO Situations:

- Excessive spillage or reverse venting of fuel-burning appliances caused by outdoor ambient conditions, such as wind direction and/or velocity, including high gusts of wind, heavy air in the vent pipes (cold/humid air with extended periods between cycles).
- Negative pressure resulting from the use of exhaust fans.
- Simultaneous operation of several fuel-burning appliances competing for limited internal air.
- Vent pipe connections vibrating loose from clothes dryers, furnaces, or water heaters.
- Obstructions in, or unconventional, vent pipe designs which can amplify the above situations.
- Extended operation of unvented fuel-burning devices (range, oven, fireplace, etc.).
- Temperature inversions which can trap exhaust gases near the ground.
- A car idling in an open or closed attached garage, or near a home.

## FCC Statement

This equipment has been tested and found to comply with the limits for a Class B digital device, pursuant to Part 15 of the FCC Rules. These limits are designed to provide reasonable protection against harmful interference in a residential installation. This equipment generates uses and can radiate radio frequency energy and, if not installed and used in accordance with the instructions, may cause harmful interference to radio communications. However, there is no guarantee that interference will not occur in a particular installation. If this equipment does cause harmful interference to radio or television reception, which can be determined by turning the equipment off and on, the user is encouraged to try to correct the interference by one or more of the following measures:

- Reorient or relocate the receiving antenna.
- Increase the separation between the equipment and receiver.
- Connect the equipment into an outlet on a circuit different from that to which the receiver is connected.
- Consult the dealer or an experienced radio/TV technician for help.

This device complies with part 15 of the FCC Rules. Operation is subject to the following two conditions:

(1) This device may not cause harmful interference, and (2) this device must accept any interference received, including interference that may cause undesired operation.

Changes or modifications not expressly approved by the party responsible for compliance could void the user's authority to operate the equipment.

## Environmental Protection

Waste electrical products should not be disposed of with household waste. Please recycle where facilities exist. Check with Local Authority or retailer for recycling advice.



## Manufacturer and Service Information

X-Sense Electronics Co., Ltd.

Address: Room 402, Building 4, No. 9, Jinshagang 1st Road, Shixia Village, Dalang Town, Dongguan City, 523750 Guangdong, P.R. China

Email: support@x-sense.com