

Read all instructions BEFORE assembly and USE of product.
KEEP INSTRUCTIONS FOR FUTURE USE.

Item#: PY86428

Check that you have all the below parts for this model
before assembling the playard.

Playard (fully assemble) x 1	Changing Table x 1
Canopy x 1	Long Curved Bar x 2
Wind up Mobile x 1	Short Bar with Connector Knob x 2
Mobile Tri-shaped Arm x 1	Parent Organizer x 1
Mattress x 1	Hook x 2
Bassinet x 1	Music Center x 1
Metal Support Tubes (2 male, 2 female)	Travel / Storage Bag x 1

Nursery Center

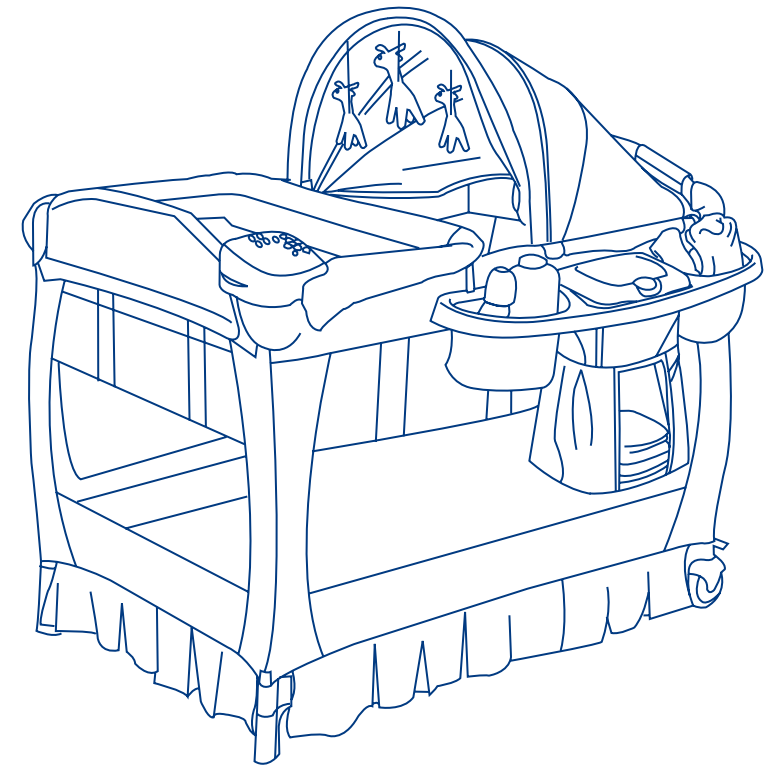

*Toys and mobile may vary



**IF YOU EXPERIENCE ANY DIFFICULTY IN USING THIS PRODUCT,
PLEASE CONTACT OUR CUSTOMER SERVICE DEPARTMENT AT
1-800-328-7363 BETWEEN THE HOURS OF 8:00 A.M. AND 4:30 P.M. PACIFIC
STANDARD TIME FOR ASSISTANCE. PLEASE HAVE YOUR MODEL NUMBER AND
MANUFACTURING DATE AVAILABLE WHEN YOU CALL. THIS INFORMATION CAN BE
FOUND ON A SMALL STICKER UNDER THE PLAYARD.**

baby trend
Convenience through innovation and thoughtful design

Contact us by mail:
Baby Trend, Inc.
1607 S. Campus Ave., Ontario, CA 91761

Contact us by phone:
1-800-328-7363 (8:00am ~ 4:30pm PST)
or online <http://www.babytrend.com>

Instruction Manual

baby trend
Convenience through innovation and thoughtful design
www.babytrend.com

12.08

⚠️ WARNING: NEVER LEAVE INFANT IN PRODUCT WITH SIDES DOWN.

Infant may roll into space between pad and loose mesh side causing suffocation.

⚠️ WARNING:

Infants can suffocate:

- In gaps between a mattress too small or too thick and product sides
 - On soft bedding
- Never add a mattress, pillow, comforter, or padding.
Use only the mattress provided by manufacturer.
Never use a water mattress with this product.

⚠️ WARNING: See playard floor and side rails for warnings.

⚠️ WARNING: Failure to follow these warnings and the instructions could result in serious injury or death.

- **NEVER** use this product if there are any loose or missing fasteners, loose joints, broken parts, or torn mesh/fabric. Check before assembly and periodically during use. Contact Baby Trend Customer Service at 1-800-328-7363 for replacement parts, repair or instructions. **NEVER** substitute parts.
- **NEVER** leave child in product with sides lowered. Be sure sides are in raised and locked position whenever child is in product.
- **NEVER** use plastic shipping bags or other plastic film as mattress covers not sold and intended for that purpose. They can cause suffocation.
- This product is not intended for commercial use.

MAINTENANCE AND CLEANING INSTRUCTIONS:

Use only household mild soap and warm water.

DO NOT USE BLEACH.
DO NOT MACHINE WASH.

-
- The playard, including side rails, must be fully erected prior to use. **Make sure latches are secure.**
 - Strings can cause strangulation! **NEVER** place items with a string around a child's neck such as hood strings or pacifier cords. **NEVER** suspend strings over playard or attach strings to toys.
 - Discontinue use of the product when child is able to climb out or has reached the height of 35 in. (890 mm) or weight of 30 lbs. (14 kgs), whichever comes first.
 - When child is able to pull to standing position, remove bumper pads, large toys and other objects that could serve as steps for climbing out.
 - **NEVER** place product near a window where cords from blinds or draps can strangle a child.
 - Always provide the supervision necessary for the continued safety of your child. When used for playing, **NEVER** leave child unattended.
 - To reduce the risk of SIDS, pediatricians recommend healthy infants be placed on their back to sleep, unless otherwise advised by your physician.

If you experience any difficulty with the use of our product or have a question regarding these instructions, please contact our Customer Service Department at 1-800-328-7363 between the hours of 8:00 a.m. and 4:30 p.m. (PST). Please do not return the product to the store as once it is returned it cannot be re-sold and the materials and energy used to make it are wasted.

Contact us by mail:
Baby Trend, Inc.
1607 S. Campus Ave., Ontario, CA 91761

Contact us by phone:
1-800-328-7363 (8:00am ~ 4:30pm PST)
or online <http://www.babytrend.com>

This model may not include some features shown below. Check the parts list to make sure you have all the parts for this model before assembling the playard.

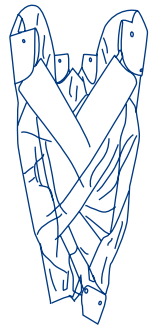

Playard



Wheel (2)



Wheel Axle (2)



Retainer (2)



Cap (2)

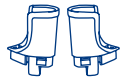

Leg (2)



Mattress

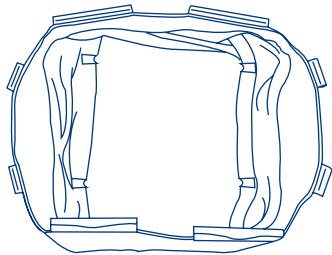

Bassinet

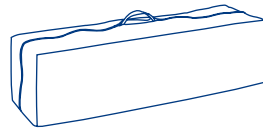

Travel / Storage Bag



Metal Support Tubes
(2 male, 2 female)



Long Curved Bar (2)

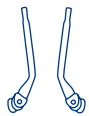

Short Bar with Connector
Knob (2)

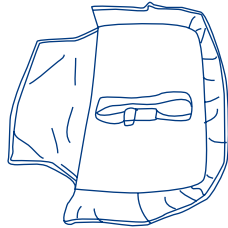

Changing Table

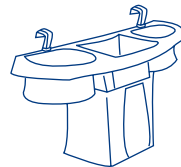

Parent Organizer*



Canopy*

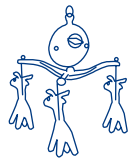

Wind Up Mobile*

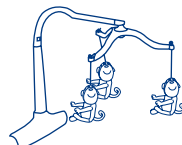

Fixed Mobile*



Music Center

* Type may vary

IMPORTANT! To ensure safe operation of your playard, please follow these instructions carefully. Please keep these instructions for future reference.

IMPORTANT! Before assembly and each use, inspect this product for damaged hardware, loose joints, missing parts or sharp edges. NEVER use if any parts are missing or broken.

IMPORTANT! Adult assembly is required.

TO ASSEMBLE PLAYARD



Playard



Wheel (2)



Wheel Axle (2)



Retainer (2)



Cap (2)



Leg (2)

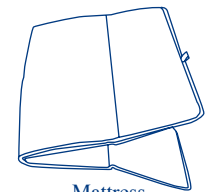

Mattress

ATTENTION:

Playard must be fully assembled and securely locked before installing or using other accessories.

1. Unzip bag and remove Playard frame (Fig. 1). Undo the three (3) Fasten straps and set the Mattress aside (Fig. 2).

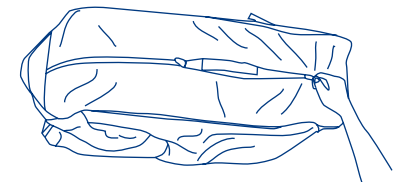

Fig. 1

2. Turn the Playard upside down.

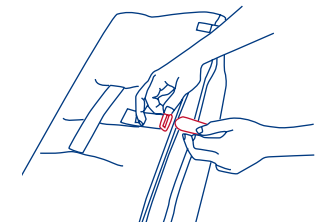

Fig. 2

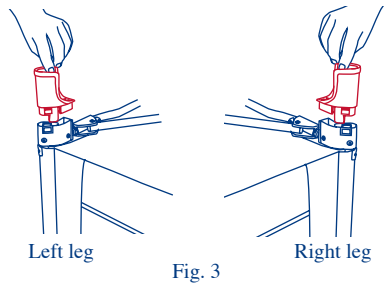

Fig. 3

ATTENTION: Some playard maybe fully assemble. If so, skip to step 5.

3. Attach the Legs to the Playard by pushing each Leg into the bottom of the leg mount until both sides snap firmly into place (Fig. 3).

IMPORTANT: Check that each Leg is securely attached before use.

4. Attach the Wheels to the Playard using the axles, retainers and caps provided. Align each Wheel and insert axle through the center (Fig. 4). Secure by pushing the retainer over the end of the axle until it snaps into place (Fig.5). Finish by pushing the cap over the end of the axle and retainer until it snaps into place (Fig. 5).

IMPORTANT: Check that each Wheel is securely attached before use.

NOTE: To operate the brakes on the Wheels, press downward on the brake levers. To release, lift upward on the lever (Fig. 6)

5. Turn the Playard right side up and keep the Legs and Wheels close together. Stretch out top of Playard and pull up one side at a time of each of the top rails until each latch “Clicks” and locks securely into place (Fig. 7).

NOTE: The best way to lock the rail(s) is to hold one hand on each side and pull up sharply. (DO NOT pull from the middle where the latch release is located).

IMPORTANT: The handle located in the center of the Playard floor **MUST** remain raised (Approx. 45.7 cm or 18 inches) while locking the side rails in place. If the center is not raised the rails will **NOT** lock.

If you experience difficulty and one side of the rail will lock but the other side will not then, unlock the rail by squeezing the release in the center and try again. If you still have difficulty, contact our Customer Service Center at 1-800-328-7363 or visit us online at www.babytrend.com.

6. Once all four (4) top rails are locked in place, push down on the center handle (Fig. 8). The center mechanism will rotate clockwise 90 degrees and automatically lock in place.

IMPORTANT: Test each top rail by pushing down slightly to confirm each is rigid and locked securely in place before use (Fig.9).

ATTENTION:

To use as a bassinet, skip to page 7 for bassinet installation instructions.

7. Place the Mattress on the floor of the Playard with the padded side facing up (Fig. 10)

8. Feed the three (3) hook and loop straps located on the underside of the Mattress through the slots in the floor of each end of the Playard (Fig. 11). Fasten the hook and loop straps to the underside of the Playard floor to prevent the Mattress from moving (Fig. 12).

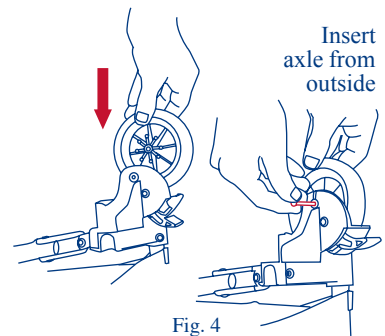

Fig. 4

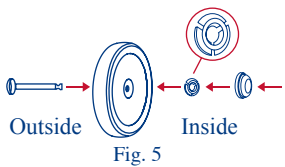

Fig. 5

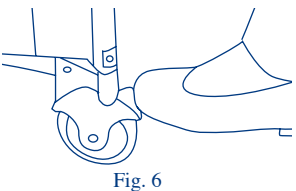

Fig. 6

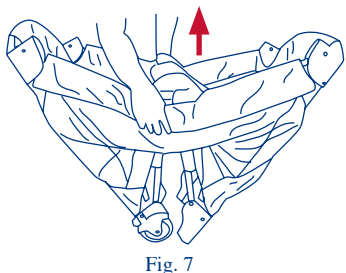

Fig. 7

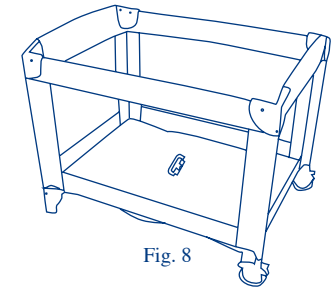

Fig. 8

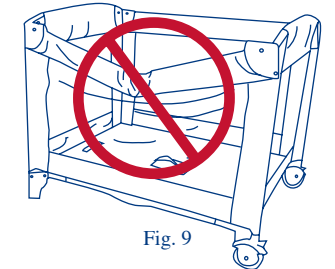

Fig. 9

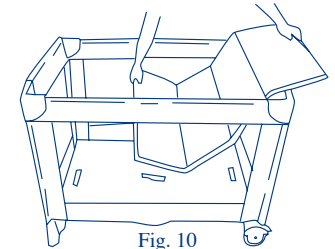

Fig. 10

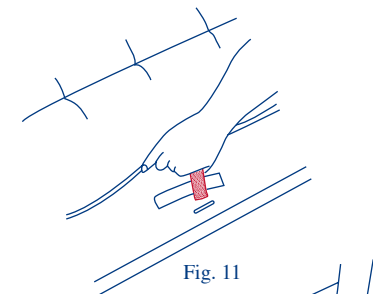

Fig. 11

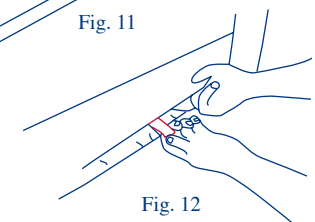

Fig. 12

ACCESSORIES



Fig. 13

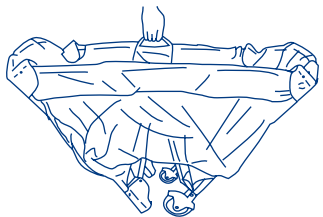

Fig. 14

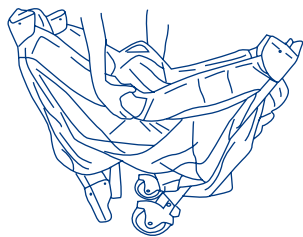

Fig. 15



Fig. 16

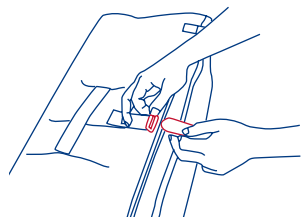

Fig. 17

FOLDING PLAYARD

1. Undo the three (3) hooks and loop straps holding the Mattress from underneath the Playard floor or remove the Mattress for the Bassinet and set aside.
2. Grasp the center handle, push down and rotate the handle counter-clockwise 90 degrees and lift upward until the handle is as high as the top rails (Fig. 13). Gather the Legs and Wheels together towards the center as close as possible so that they nearly touch (Fig. 14).

NOTE: The top rails of the Playard are still in the "Locked" position.

3. Locate the rail release lever in the center and bottom side of each rail. Lift slightly while squeezing the lever until the rail "Clicks" and releases. Push down each side of the rail while still holding the release lever until both sides are down. Repeat for all remaining sides (Fig. 15).

NOTE: If the top rail(s) do not release completely, **DO NOT FORCE!** Check the floor of the Playard to make sure all the bottom rails are unlocked and make sure the middle handle is pulled up and has not fallen back down. If so, repeat step #3.

4. Gather four (4) corners and center all together tightly (Fig. 16).
5. Wrap Mattress around Playard frame with padded side facing inward.
6. Secure the three (3) hook and loop straps by feeding them through the loops on the end of the Mattress and folding them back onto themselves (Fig. 17).
7. Place folded Playard into carry bag so that the handle comes through the opening between each side of the zipper.

⚠ WARNING: Failure to follow these warnings and the instructions could result in serious injury or death.

⚠ FALL HAZARD: To help prevent falls, do not use this product when the infant begins to push up on hands and knees or has reached the height of 25 in. (635 mm), weight of 15 lbs. (6.8 kgs) or 4 months old, whichever comes first.

⚠ SUFFOCATION HAZARD: Infants can suffocate

- In gaps between an extra pad and sides of the bassinet/cribble
- On soft bedding

Never add a mattress, pillow, comforter, or padding. Use only the pad provided by manufacturer. Never use a water mattress with this product.

- To reduce the risk of **SIDS**, pediatricians recommend healthy infants be placed on their back to sleep, unless otherwise advised by your physician.
- The playard, including side rails, must be fully erected prior to use. **Make sure each latch is secure.**
- Strings can cause strangulation! **NEVER** place items with a string around a child's neck such as hood strings or pacifier cords. **NEVER** suspend strings over bassinet or attach strings to toys.
- Discontinue use of the bassinet or the changing table when child begins to push up on hands and knees or has reached the height of 25 in. (635 mm), weight of 15 lbs. (6.8 kgs) or 4 months old, whichever comes first.
- **NEVER** place product near a window where cords from blinds or drapes can strangle a child.
- Always provide the supervision necessary for the continued safety of your child. **NEVER** leave child unattended.
- **NEVER** use plastic shipping bags or other plastic film as mattress covers not sold and intended for that purpose. They can cause suffocation.
- Use bassinet with only one child at a time.
- **NEVER** place a child under the bassinet.
- **NEVER** store the bassinet in the playard while in use.
- The bassinet must be fully assembled and installed before using.
- **STRANGULATION HAZARD: NEVER** leave the changing table in place when the child is in the bassinet or the playard. Always flip changing table down while not in use.
- To prevent your child from falls and other injuries, always use safety belt when child is on the changing table, always stay within arm's reach of your child when using the changing table.
- To help prevent heat build-up inside the playard and to avoid overheating your child, when using the bassinet **NEVER** use an outdoor canopy.

TO ASSEMBLE BASSINET



Metal Support Tubes
(2 male, 2 female)

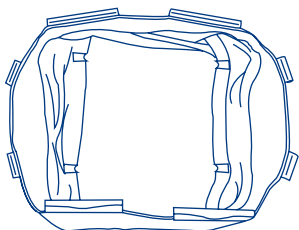

Bassinet

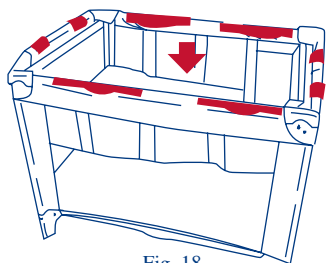

Fig. 18



Fig. 19

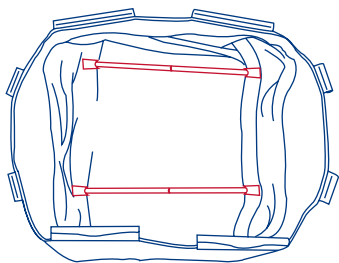

Fig. 20

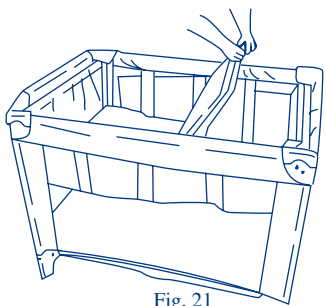

Fig. 21

ATTENTION:

Playard must be fully assembled and securely locked before installing or using the bassinet feature. (See To Assemble Playard section)

You will need to remove the mattress from the bottom of the Playard to use inside your Bassinet.

1. Position the Bassinet over and down into the fully assembled Playard. Secure in place by pushing down firmly on each plastic support clip until all are snapped into place (Fig. 18).
2. Assemble Mattress Support Tubes (if equipped; otherwise, skip to step 4) by inserting the two (2) male tubes into the two (2) female tubes (Fig. 19).
3. Insert both, assembled, Mattress Support Tubes into the loops provided on the bottom of the Bassinet (Fig. 20).
4. Place the Mattress into the Bassinet with the padded side facing upward (Fig. 21)

NOTE: Fasten tabs underneath the Mattress secure it in place.

TO REMOVE BASSINET

1. Remove Mattress from Bassinet.
2. Remove Canopy.
3. Unsnap all clips and lift Bassinet.

TO ASSEMBLE CANOPY

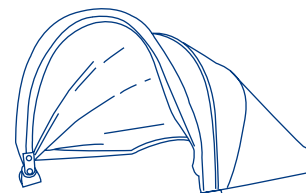

"C" Shape Canopy

or



"U" Shape Canopy

ATTENTION:

If the equipped Canopy comes in "U" shape (Fig. 22), you need to assemble the Canopy before attach to the playard. If the Canopy comes in "C" shape, skip to step 3.

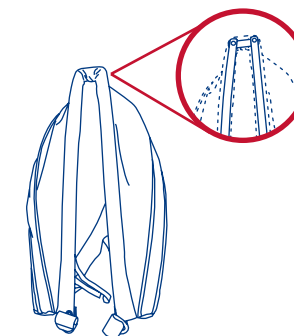

Fig. 22

1. Open Canopy as seen in Fig. 23, make opening adjustments at the top of Canopy by aligning the inner center strap with the two outer straps. (Fig. 24.)

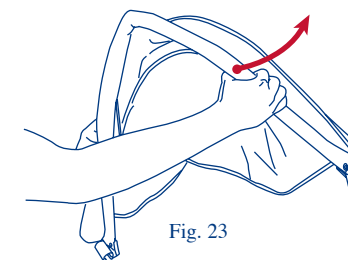

Fig. 23

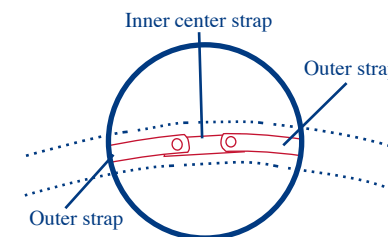

Fig. 24

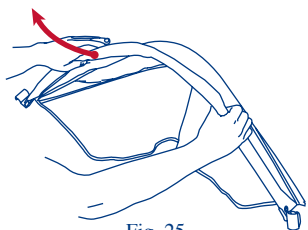

Fig. 25

2. Open Canopy completely and feel the top center of the Canopy to ensure that the straps are aligned correctly so the Canopy fits on the Playard. (Fig 25.)

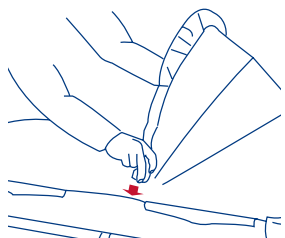

Fig. 26

3. Position Canopy in the center of Playard.

4. Attach each side of Canopy by firmly pressing Canopy clips onto the center of the top rails as close to the center as possible. (Fig. 26)

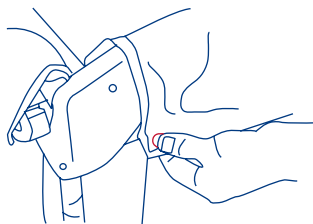

Fig. 27

5. Attach the other end of the Canopy to the Playard by snapping the two (2) buttons or velcro located near each corner of the Playard. (Fig. 27)

NOTE: Your canopy comes with plush toys if your unit does not include a mobile.

TO REMOVE CANOPY

Unsnap the Canopy and pull upward on the ends of the Canopy from the side of the Playard.

MOBILE ASSEMBLY (Wind Up or Fixed)

ATTENTION:

DO NOT attach Mobile to Canopy until Canopy is correctly installed as noted in the Canopy instructions.

A crib mobile is intended for visual stimulation and is not intended to be grasped by the child.

If attached to the crib or playpen, remove when baby begins to push up on hands and knees. If so designed, mount on wall or ceiling clearly out of a standing baby's reach. Always attach all provided fasteners (strings, straps, clamps, etc.) tightly to a crib or playpen according to the instructions. Check frequently.

DO NOT add additional strings and straps to attach to a crib or playpen.

DO NOT attach the Mobile with child in Playard or Bassinet.

DO NOT remove the Mobile before retracting the Canopy or removing the Canopy.

Wind Up Mobile

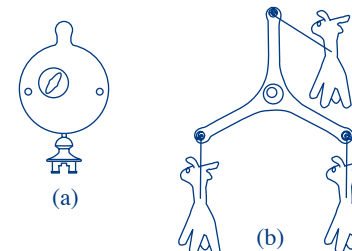

Contents:

- (a) 1 Wind Up Mobile
- (b) 1 Mobile Tri-shaped Arm (toys may vary)

1. Attach the Mobile (a) to the Tri-shaped Arm (b) align slots on both pieces then gently press the two pieces together. (Fig. 28).

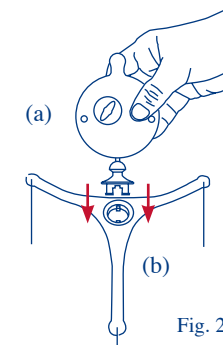

Fig. 28

2. Attach the Mobile to Canopy using the Velcro and connecting the straps together through the hole in the top of the Mobile housing (Fig. 29).

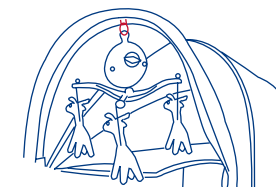
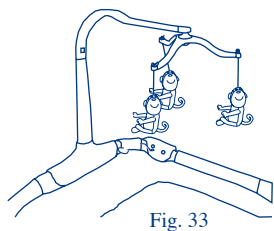
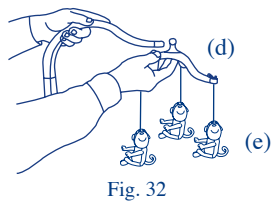
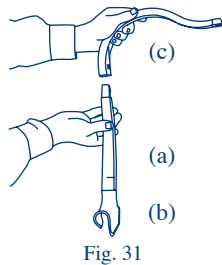
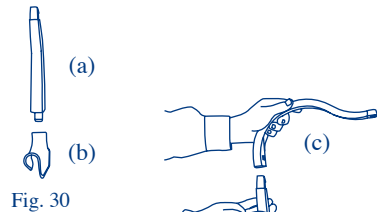
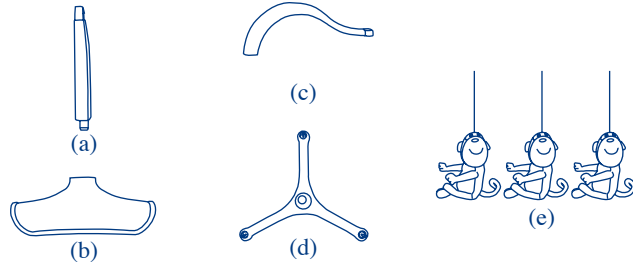

Fig. 29

Fixed Mobile



Contents:

- (a) 1 Mobile Lower Arm
- (b) 1 Mobile Arm Holder
- (c) 1 Mobile Upper Curved Arm
- (d) 1 Mobile Tri-shaped Arm
- (e) 3 Toys (toys may vary)

1. Insert the Mobile Lower Arm (a) into the Mobile Arm Holder (b) until locked together (Fig. 30).
2. Insert the Mobile Upper Curved Arm (c) into the Mobile Lower Arm (a, b) until locked together (Fig. 31).
3. Snap the Mobile Tri-shaped Arm (d) onto the end of the Upper Curved Arm (a, b, c) (Fig. 32). Connect each of the three Toys (e) to the Mobile by threading the string into the slot at the end of each arm.
4. Insert the bottom of the Mobile Arm into the frame of the Playard (Fig. 33).

TO ASSEMBLE CHANGING TABLE

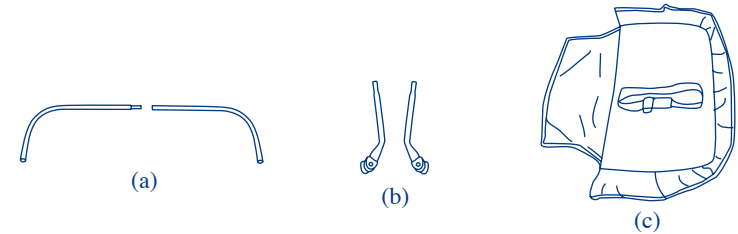

⚠ WARNING
FALL HAZARD: To prevent death or serious injury, always keep child within arm's reach.

Always use restraint belt to prevent falls, see page 15 for details.

Contents:

- (a) 2 Long Curved Bars
- (b) 2 Short Bar with Connector Knobs
- (c) 1 Changing Table

ATTENTION:

Playard must be fully assembled and securely locked before installing or using the changing table feature. (See To Assemble Playard section)

1. Connect the two (2) Long Curved Bars together (Fig. 34).
2. Insert the assembled curved bars into the Changing Table fabric (Fig. 35) Slide the Curved Bars around inside sleeve of the Changing Table.
3. Connect the two (2) Short Bars to each end of the Long Curved Bar (Fig. 36) Make sure that the knobs are both facing down and the same direction on each end. (Fig. 37)

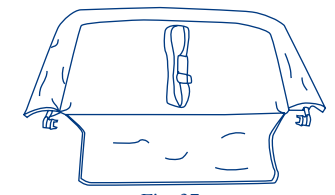
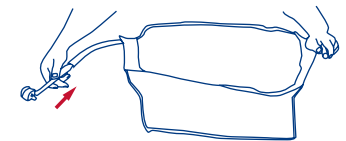
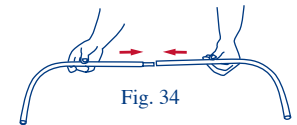

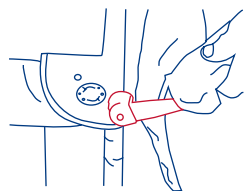

Fig. 38

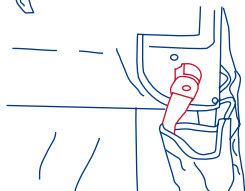

Fig. 39

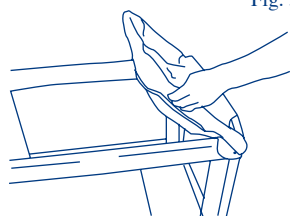

Fig. 40

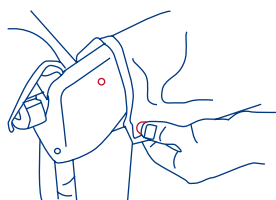

Fig. 41

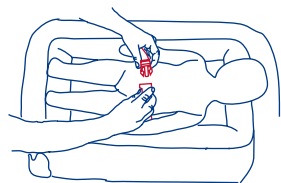

Fig. 42

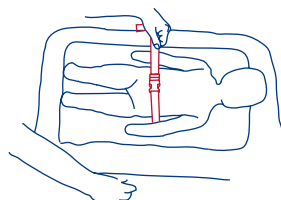

Fig. 43

4. Insert Connector Knob Prongs into holes located on both corners of the Playard (Fig. 38).

5. Turn the Connector Knobs counter clockwise to lock into place (Fig. 39).

6. Flip Changing Table over onto Playard (Fig. 40).

7. Snap the two (2) buttons on the flap down onto the Playard (Fig. 41).

IMPORTANT: Check that the Changing Table is correctly and securely installed BEFORE each use.

To use changing table restraint system

1. Place child on changing table, make sure hand and arms are clear of the restraint. Bring the restraint around the child's waist and clip the male and female ends of the buckle together. (Fig. 42)

2. Tighten strap until fits snug around child's waist. **DO NOT OVER TIGHTEN.** (Fig. 43)

3. To remove, unsnap the buckle.

ATTENTION: NEVER use changing table if it is damaged or broken.

To remove changing table

Flip Changing Table to the outside of the Playard. Unsnap fabric flap of Changing Table from Playard. Twist Connector Knobs clockwise to unlock. (Fig. 44) Remove Changing Table from Playard (Fig. 45) and disconnect the Short Bars from the Curved Bar by pressing on the snap buttons and pulling apart. Remove Curved Bar from Changing Table sleeve.

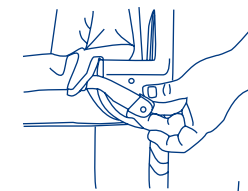

Fig. 44

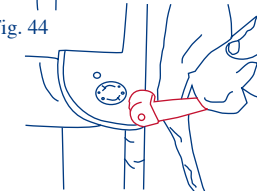
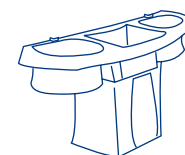

Fig. 45

PARENT ORGANIZER ASSEMBLY



Parent Organizer



or

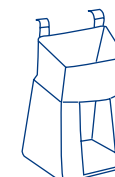

Diaper Stacker

1. Parent Organizer: Position each hook so that the hooked end is facing the rear side of the organizer. Press the hook down firmly into the slot until it snaps into place. (Fig. 46)

Diaper Stacker: Skip to step 2.

2. Connect the Parent Organizer/Diaper Stacker to the Playard by sliding the two (2) connecting clips over an open portion of the top rail of the Playard. (Fig. 47)

NOTE: The Parent Organizer/Diaper Stacker can only be installed on open sides of the Playard where the connecting clips can easily be attached without interfering with other features.

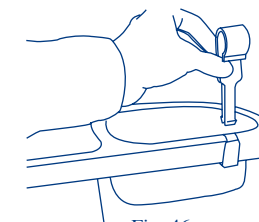

Fig. 46

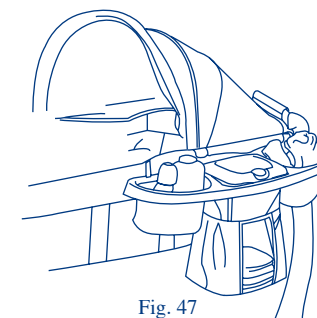

Fig. 47

⚠ WARNING: Keep batteries out of children's reach. Old and new batteries should not be mixed. Alkaline, standard carbon-zinc, and rechargeable nickel-cadium batteries should not be mixed. Remove batteries before storing music center for a long period of time.

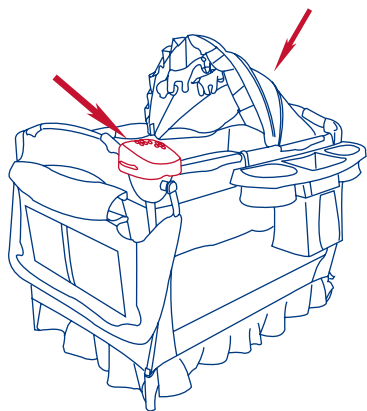

Fig. 50

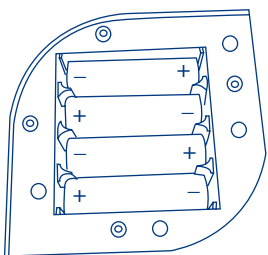



Fig. 51



MUSIC CENTER



The Music Center is designed to be attached to the playard corners. It can be attached on the Changing Table's side or the Canopy's side. See figure 50.



MUSIC OPERATION



The Music Center requires 4 AA batteries. Please see figure 51 for battery installation. Unscrew the battery door screws and pull outward on the battery door. Install batteries as shown. Re-install battery door and secure with screws.



 To activate the unit, press the on/off button. Press button a second time to switch unit off.



 To listen to SLEEP music, press the SLEEP button. You may use the previous / next button to change the song. The Vol  or Vol  buttons control the units volume.



 To listen to PLAY music, press the PLAY button. You may use the previous / next button to change the song. The Vol  or Vol  buttons control the unit's volume





 To listen to NATURE sounds, press the NATURE button you may use the previous / next button to change the sound. The Vol  or Vol  buttons control the unit's volume.

 VIBRATION: To use the vibration button press down  once to activate the speed, press again for a Medium speed and once more for the faster speed. Press  to reduce the speed.

 NIGHT LIGHT: To use the night light, press the  button. The light has 3 settings of brightness and is controlled by the  button.

 VOICE RECORDER: To use the Voice record function press the  button and speak into the microphone to record your 10 second voice message. Press  to hear the message.

 VOICE ACTIVATION: To use the Voice Activation function press the  button twice if the unit is power off. If the unit is already power on, press the  button once. The voice activation light will be illuminated when in voice activation mode. If your infant cries his/her voice will activate the sleep music to come on and play. When voice activation is enabled, sleep mode is active for 2 hrs.

 MP3 FUNCTION: Use the input jack to attach your MP3 player into the unit . Press the  button to select the MP3 input. Your MP3 music will then be played through the unit and will over-ride the unit's music. To listen to the unit's music, depress the  button. Volume will be controlled by the MP3 player.

